

MÖBELGRIFF RIEMEN

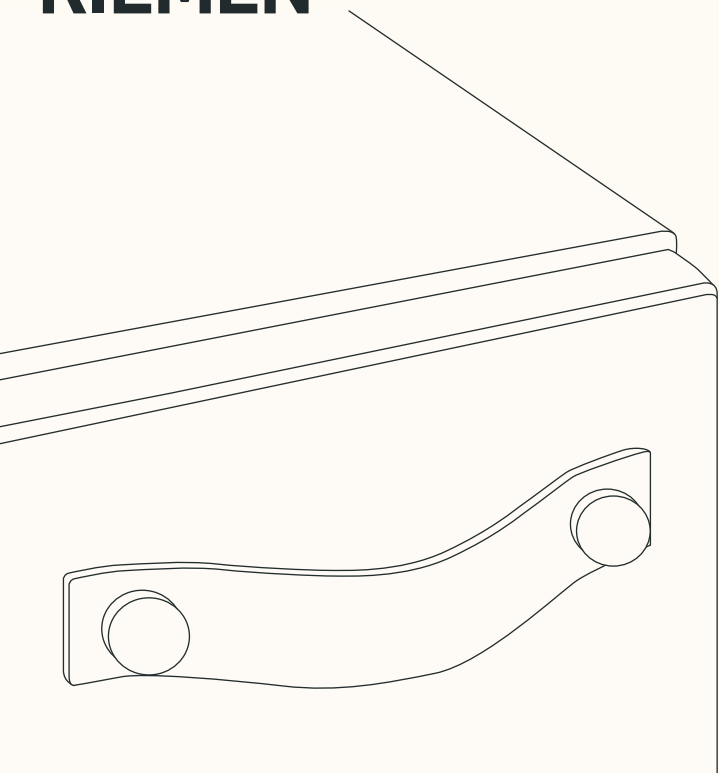

Benötigtes Werkzeug

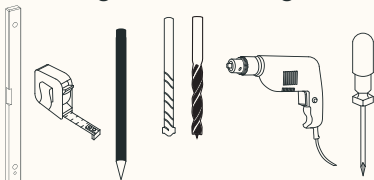

Montage-Set

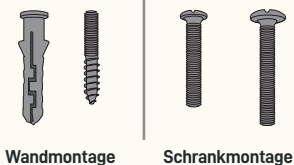

Wandmontage

Schrankmontage

VIEL SPASS 😍

Wenn Du Hilfe beim Aufbau benötigst, dann wende Dich gern an unseren Expertenservice: support@naturalgoodsberlin.de

NATURAL GOODS BERLIN

naturalgoodsberlin.de | + 49 (0) 33397 647330

n.g.

1

Montage an der Wand

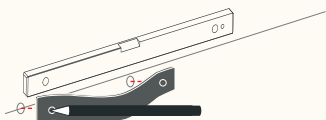

Montage an einer Schranktür

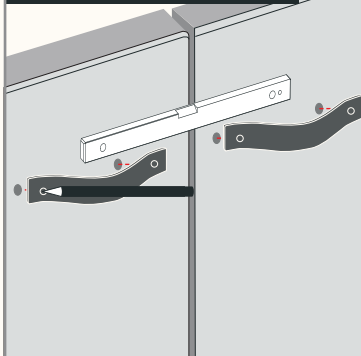

2

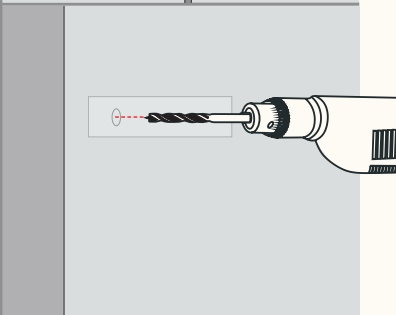
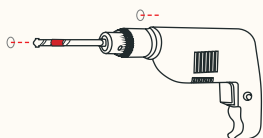
**Bohrrichtung beachten**

- in die Schranktür von **vorne bohren**
- **Expertentipp:** Kreppband drüber kleben

3

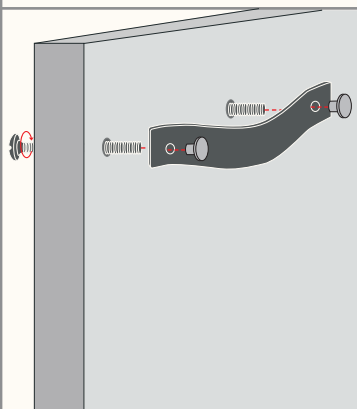
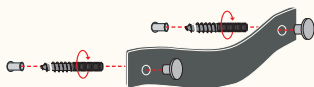

PERFEKT!



Wir sind ein junges Unternehmen und freuen uns über Deine positiven Bewertungen, Anregungen und Erfahrungen.



@naturalgoodsberlin

Teile Dein DIY-Projekt und sei Anderen eine Inspiration.

n.g.