

User Manual

and Safety Instructions

NEED HELP?

call us:



435-752-6611

email us:



cs@heatstorm.com



PHOENIX INFRARED HEATER

1500 W - FORCED AIR - QUARTZ INFRARED ELEMENT

SAVE THIS INSTRUCTIONS MANUAL









Visit us at:

heatstorm.com

for more product information

Model:
HS-1500-PHX
HS-1500-PHXG

TABLE OF CONTENTS:

	Introduction.....	1
	Safety Awareness.....	2
	Installation & Instructions.....	6
	Operations & Controls.....	10
	Troubleshooting Guide.....	16
	Questions & Answers.....	18
	Return Policy.....	22
	1 Year Limited Warranty.....	23





Introduction

Thank you and congratulations on the purchase of your Heat Storm Phoenix Infrared Heater!

PLEASE READ THIS MANUAL BEFORE OPERATING THIS APPLIANCE.



WARNING:



IF THE DIRECTIONS IN THIS MANUAL ARE NOT FOLLOWED, AN ELECTRIC SHOCK OR FIRE MAY RESULT CAUSING PROPERTY DAMAGE, PERSONAL INJURY OR LOSS OF LIFE.



DO NOT STORE OR USE GASOLINE OR OTHER FLAMMABLE VAPORS AND LIQUIDS IN THE VICINITY OF THIS OR ANY OTHER HEATING APPLIANCE.



ANY REQUIRED SERVICE OTHER THAN FILTER MAINTENANCE SHOULD ONLY BE PERFORMED BY AN AUTHORIZED SERVICE REPRESENTATIVE.



ANY OTHER REPAIRS ATTEMPTED BY ANYONE OTHER THAN AN AUTHORIZED SERVICE REPRESENTATIVE WILL VOID THE WARRANTY.



Safety & Awareness

IMPORTANT INSTRUCTIONS

When using electrical appliances, basic precautions should always be followed to reduce the risk of fire, electric shock, and injury to persons, including the following:

Read all instructions before installing or using this heater.

This heater is hot when in use. To avoid burns, do not let bare skin touch hot surfaces. Keep combustible materials, such as furniture, pillows, bedding, papers, clothes, etc. and curtains at least 3 feet (0.9 m) from the front of the heater and keep them away from the sides.

Extreme caution is necessary when any heater is used by or near children or invalids and whenever the heater is left operating and unattended.

Do not operate any heater after it malfunctions. Disconnect power at service panel and have heater inspected by a reputable electrician before reusing.

To disconnect heater, turn controls to off, and turn off power to heater circuit at main disconnect panel.

CAUTION: TO PREVENT ELECTRIC SHOCK, MATCH WIDE BLADE OF PLUG TO WIDE SLOT AND FULLY INSERT

In order to avoid overheating, do not cover the heater. It cannot be used in a wardrobe.

CAUTION: Whenever the heater is left operating and unattended, caution may be necessary if children or invalids are nearby.

The appliance should not be used by children or persons with reduced physical, sensory or mental capabilities, or lack of experience and knowledge, unless they have been given supervision or instruction.

Thermostat Functionality Chart

Under low mode, green "low" will be illuminated.

LOW MODE	when room temp warm up		when room temp cool down	
	73	off	73	off
	72	50% Power	72	off
	(setting temp)71	50% Power	(setting temp)71	off
	70	50% Power	70	Off
	69	50% Power	69	50% Power
	↑ Example for temperature setting at 71°F			

Under auto mode, white "auto" will be illuminated.
Example for temperature setting at 71°F

AUTO MODE	73	off
	72	off-50% Power
	(setting temp)71	50% Power
	70	50-100% Power
	69	100% Power

Under high mode, red "high" will be illuminated.

HIGH MODE	when room temp warm up		when room temp cool down	
	73	off	73	off
	72	100% Power	72	off
	(setting temp)71	100% Power	(setting temp)71	off
	70	100% Power	70	Off
	69	100% Power	69	100% Power
	↑ Example for temperature setting at 71°F			



ZONE HEATING

Who knew saving money
could look so good...

Children being supervised should be instructed not to play with the appliance.

Do not operate any heater with a damaged cord or plug or after the heater malfunctions, has been dropped or damaged in any manner. Discard heater, or return to an authorized service facility for examination and/or repair.

If the supply cord is damaged, it must be replaced by the manufacturer, its service agent, or similarly qualified persons in order to avoid a hazard.

Any repairs to this heater should be carried out by a qualified service person.

Under no circumstances should this heater be modified. Parts having to be removed for servicing must be replaced prior to operating this heater again.

Do not use outdoors.

Do not run the cord under carpeting. Do not cover the cord with throw rugs, runners, or similar coverings. Do not route cord under furniture or appliances. Place the cord away from high traffic areas. Place cord where it will NOT cause tripping hazard.

To disconnect the heater, turn controls to the off position, wait for the fan to stop blowing to ensure the inside of the heater has been properly cooled, then remove plug.

Connect to proper 2 pin polarized outlets only.

When using electrical appliances, basic precautions should always be followed to reduce risk of fire, electrical shock, and injury to persons.

There is a thermostat limiter inside the heater. When the inner temperature over-heats or abnormal heating occurs, the thermo-

stat protective device will cut off power supply to avoid risk of fire or damage to the heater.

Do not insert or allow foreign objects to enter any ventilation or exhaust opening as this may cause an electric shock, fire, or damage the heater.

To prevent a possible fire, do not block air intakes or exhaust in any manner.

The heater has hot and arcing or sparking parts inside. Do not use it in areas where gasoline, paint or flammable liquids are used or stored.

Use this heater only as described in the manual. Any other use is not recommended by the manufacturer because it may cause fire, electric shock or injury to persons.

Always plug heaters directly into a wall outlet/receptacle.

Never use with an extension cord or relocatable power tap (outlet/power strip). This heater is for use on 120 volt standard outlets.

HEATER LOCATION

When choosing a location for your new heater, ensure that the general instructions are followed. For best effect, install the heater out of direct sunlight. Cold climate installation recommendation: when installing this unit against a non-insulated exterior wall or chase, it is mandatory that the outer walls be insulated to conform to applicable insulation codes. If you choose to place the unit underneath a window or on a poorly insulated exterior wall, please be advised that the heater may read a colder ambient temperature than what the actual ambient temperature of the room is.

Contact the manufacturer by calling customer service department at **435-752-6611**. Make sure you have your sales receipt, the location of purchase, and the model of your product.

When you contact customer service, they will attempt to troubleshoot the problem with you over the phone. If troubleshooting does not work, you will be asked to email proof of purchase and a picture of the manufacturer sticker to **cs@heatstorm.com**

If you have had your unit longer than the return policy (30 days), you will be expected to pay for shipping the heater back to us. If you would like to use our discounted shipping rates, please let your customer service representative know.

Please be advised that once we receive your unit, it may take a couple of business days for our technicians to determine if your unit can be fixed. If your unit can be fixed, the technicians will do so. You will **ONLY** receive a new unit if your heater is not repairable.

the product, its components, and accessories, or any obligations/liabilities on the part of the manufacturer are hereby expressly excluded.

8. The manufacturer neither assumes nor authorizes any third party to assume on its behalf, any other liabilities with respect to the sale of the product.

9. The warranties as outlined in this document do not apply to non-accessories used in conjunction with the installation of this product.

10. This warranty gives you specific legal rights, and you may also have other rights which vary from state to state. This warranty is void if:

- a) The heater is subjected to prolonged periods of dampness or condensation.
- b) Any unauthorized alteration, willful abuse, accident, or misuse of the product.
- c) You do not have the original receipt of purchase.

CAUTION: Do not exceed the current rating of the current tap. Always plug heaters directly into a wall outlet/receptacle. Never use with an extension cord or relocatable power tap (outlet/ power strip).

CLEARANCE TO COMBUSTIBLES

Keep electrical cords, drapery, furniture and other combustibles at least 3 feet (0.9M) from the front of the heater and away from the sides.

WARNING: Make sure the power is turned off before proceeding. Any electrical repairs or rewiring of this unit should be carried out by a licensed electrician in accordance with national and local codes.

If repairing or replacing any electrical component or wiring, the original wire routing, color coding and securing locations must be followed.

WARNING: Electrical outlet wiring must comply with local building codes and other applicable regulations to reduce the risk of fire, electrical shock and injury to persons.

WARNING: Do not use this heater if any part of it has been under water. Immediately call a qualified service technician to inspect the heater and replace any part of the electrical system.

Warning: Disconnect power before attempting any maintenance or cleaning to reduce the risk of fire, electrical shock or personal injury.

Warning: During any service of this appliance, the power to the unit must be turned off. First turn the main power switch to the "OFF" position, wait for the fan to stop blowing to ensure the inside of the heater has been properly cooled. Then remove the electrical plug from the wall outlet.

Voltage protection: If heater is plugged in a 240V outlet by mistake, the PCBA will cut off the heating and fan immediately, it will show a "UH" error code and , and the heater must be unplugged. The heater will function properly when plugged in the right voltage.

Save these instructions



Installation & Instructions

WALL INSTALLATION

THE HEATER MUST BE PROPERLY INSTALLED BEFORE IT IS USED.

CAUTION – High temperature, risk of fire, keep electrical cords, drapery, furnishings, and other combustibles at least 3 feet (0.9 m) from the front of the heater and away from the side and rear. To reduce the risk of fire, do not store or use gasoline or other flammable vapors and liquids in the vicinity of the heater.

Tools needed for installation:

3/16" drill bit and a Philips screwdriver

1. Use the included level template to ensure you mark the guide holes correctly
2. Drill holes for included anchors and screws. Insert top 2 screws first
3. Hang the heater onto the top 2 screws
4. Screw in final 2 screws into bottom base anchors holes to secure heater onto wall
6. This heater is hot when in use. To avoid burns, do not let bare skin touch hot surfaces. Keep combustible materials, such as furniture, pillows, bedding, papers, clothes, etc. and curtains at least 3 feet (0.9 m) from the front of the heater and keep them away from the sides
7. The heater is not to be used in wet or moist locations



1 Year Limited Warranty

MODELS: All models and accessories

The manufacturer warrants this product to be free from manufacturing and material defects for a period of one year from date of purchase, subject to the following conditions and limitations.

1. Install and operate this Electric Heater in accordance with the installation and operating instructions furnished with the product at all times. Any unauthorized repair, alteration, willful abuse, accident, or misuse of the product shall nullify this warranty.
2. This warranty is non-transferable and is made to the original owner, provided that the purchase was made through an authorized supplier of the product.
3. The warranty is limited to the repair or replacement of part(s) found to be defective in material or workmanship, provided that such part(s) have been subjected to normal conditions of use and service after said defect is confirmed by the manufacturer's inspection.
4. The manufacturer may, at its discretion, fully discharge all obligations with respect to this warranty by refunding the wholesale price of the defective part(s).
5. Any installation, labor, construction, transportation, or other related costs/expenses arising from defective part(s), repair, replacement, or otherwise of same, will not be covered by this warranty, nor shall the manufacturer assume responsibility for same.
6. The owner/user assumes all other risks, if any, including the risk of any direct, indirect or consequential loss or damage arising out of the use, or inability to use the product, except as provided by law.
7. All other warranties – expressed or implied –with respect to



Return Policy

If you purchased the heater directly from EnergyWise Solutions, we will refund the total sales amount when merchandise is received: 1) in new condition, 2) packed in its original manufacturer's box and all original packaging material included, 3) original manuals and any accessories that came with the item also included.

Manufacturer Return Policy: If you have purchased a product that needs an Exchange, Refund or Warranty claim the buyer will be responsible for all freight/shipping charges after 30 days of the purchase date.

FEET INSTALLATION

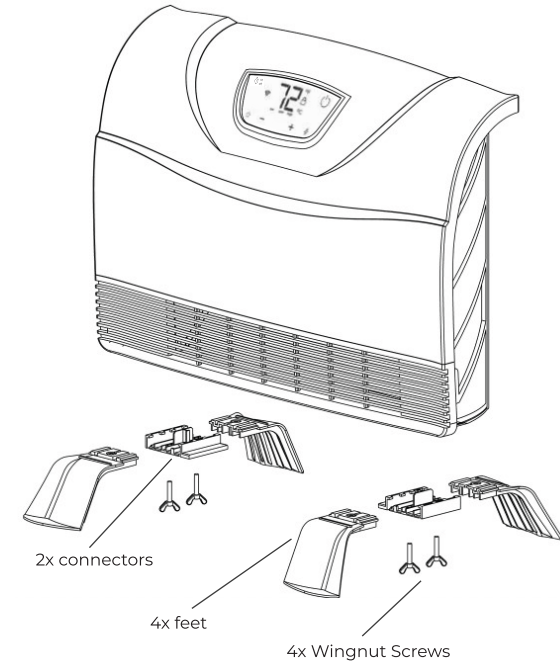

WALL INSTALLATION

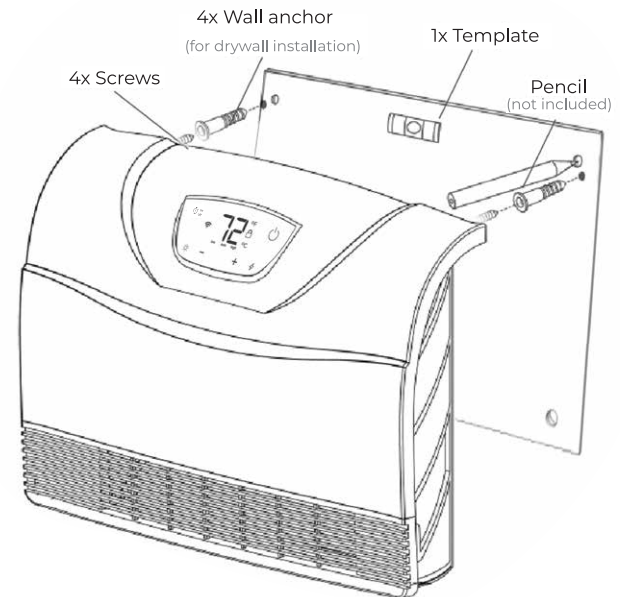

1. Use the included level template to ensure you mark the guide holes correctly

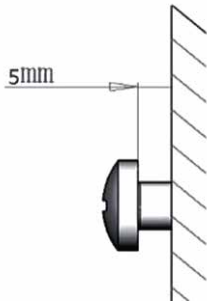
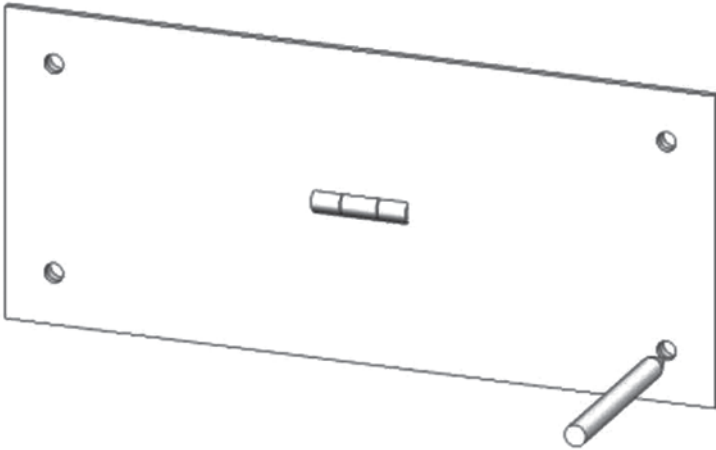

2. Drill holes for included anchors and screws.
Insert top 2 screws first

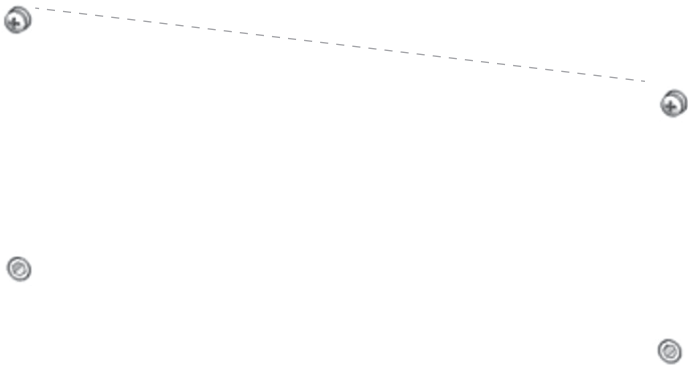

What is Zone Heating?

Zone heating implies that there are multiple areas in any given home or business where climate is best controlled by heaters that generate and deliver heat in each area or zone AND regulate temperature in each area or zone with its own thermostat. Zone Heating is the opposite of central heating which generally relies on a single thermostat to determine climate control for other areas of the house or business. Central heating also requires ducting to deliver heat, which is very inefficient.

Can I use this heater as a primary heat source?

Yes, but the heaters were not designed or advertised for this use. The heater will only be able to heat up about 150 square feet, depending on your insulation. If you are using this heater as a primary heat source and it is constantly running, the heater may not be able to keep up.

mend the second heater. The heaters will work together and spend more time in eco mode. This will prolong the lifespan on your elements, save on power, and ensure that your room warms up faster.

Can I use the heater on a job / construction site?

Our outdoor infrared heaters are recommended for non-insulated or outdoor environments. For more information visit: heatstorm.com

Can I move the heater around while it is operating?

It is not recommended to move any portable heater while it is operating. We recommend turning the heater to the off position and moving the heater once the fan has completely turned off.

What is the life expectancy for the Quartz Elements?

Average element life is 20,000 hours. The Quartz Elements are replaceable by an authorized service dealer.

Can I use the heater and another appliance at the same time?

Yes, as long as they are not on the same electrical circuit. Heat Storm Infrared Heaters are considered to be an appliance. You should not run more than one large appliance on a single circuit breaker. Your heater, freezer, refrigerator, microwave oven, washing machine, dryer, and other such appliances should not share a circuit breaker.

Can I use an extension cord, surge protector, or power strip with my heater?

No, we do not recommend to use any use an extension cord, surge protector, or power strip

What happens if I unplug the unit before the blower has finished it's cooling down cycle?

When heater is unplugged in working status the fan will blow as soon as the heater is plugged in again. When heater is unplugged in standby status the fan will not blow when the heater plugs in again. If the heater did not finish the cooling procedure when it was unplugged, the fan will blow immediately when the heater turns on by pressing on/off icon.

3. Hang the heater onto the top 2 screws

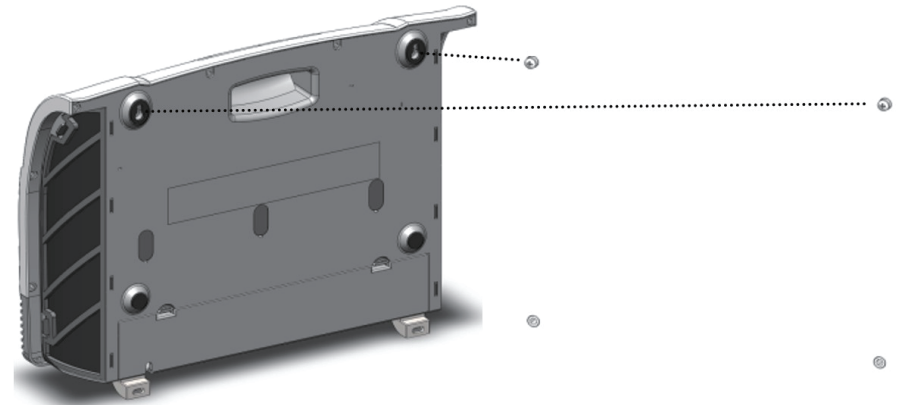







4. Screw in final 2 screws into base anchor holes to secure heater onto wall

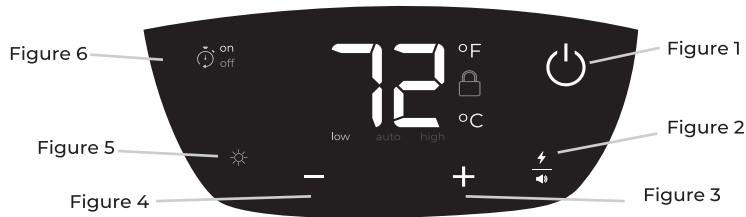



Operations & Controls



Icon	What you do:	What heater will do:	Function Status:
 Figure 1	Single touch	Turn On/Off the heater	Both Standby and on status
	5 second long touch	Turn On/Off the child lock Press and hold power icon for 5 seconds. You should hear a beep sound. The red lock icon will appear. Press and hold power icon again for 5 seconds to dis-engage.	Both Standby and on status
	10 second long touch	Enter temperature calibration mode: Count to 10 seconds while finger is touching power icon. A beep sound is heard. The temperature number will be flashing. Touch + or – to calibrate the temperature.	On status
 Figure 2	Single touch	Shift working mode from Low-Auto-High-Low	On status
	5 second long touch	Turn on/off beep sound	On status
 Figure 3	Single touch	Touch a single time to increase temperature one degree. Hold for a rapid incremental temperature increase.	Both Standby and On status
 Figure 4	Single touch	Touch a single time to decrease temperature one degree. Hold for a rapid incremental temperature decrease.	Both Standby and On status
 Figure 5	Single touch	Alternate between Fahrenheit and Celsius.	On status
			On status
 Figure 6	Single touch	Set delay on and delay off time Under “standby” status: You can set both delay on and delay off time. Touch the timer icon to enable edit mode. Display will flash. Press + or - symbols to add or take away hours to the “ON” timer. Single touch icon again to switch to “delay off” mode. Follow same instructions above to add or take away time. Wait 5 seconds for timer settings to activate. Under “on” status: When heater is on, you can only set “delay off” timer.	Both Standby and On status
			10 second long touch

Can I use the heater to heat multiple rooms at the same time?

Yes. Keep in mind the heating will vary based on how open your floor plan is and the sizes of the rooms involved. Our suggestion, give it a try and see what works best for you. Please be advised that this heater is good for between 700-1000 square feet of supplemental heating.

My Heater never seems to reach the set temperature, it just keeps running.

There are several possible causes. Make sure the filters are clean. If the room is drafty or poorly insulated the thermostat sensor may be taking an inaccurate reading. Make sure to keep doors closed so that the heater can heat the room. Also, ensure that the heater is plugged into an interior wall and is not below a window. Often, when a heater is below a window the cool air from the window is causing an inaccurate temperature reading. If none of the above assist with the problem, your heater may be too small for the room. This heater is good for between 700-1000 square feet of supplemental heating and approximately 150 square feet of primary heating. The square footage amounts will vary depending on how well insulated your home is.

My home is not insulated very well, will this heater help me?

Yes, but keep in mind that rooms with little insulation will not retain the heat as efficiently and may result in your heater running longer or more often.

Can I use the heater if I have vaulted or cathedral ceilings?

Yes, but it may take longer to heat the room initially. Once the room has reached the desired temperature it will cycle on and off accordingly.

Will I be able to use the heater in a basement or garage?

Yes, if the basement is finished with drywall and carpet. Otherwise we recommend you use our Heat Storm Outdoor Infrared Heaters for this heating need. For more information visit heatstorm.com or contact customer service.

Can I use more than one heater at a time?

Yes, but make sure they are not on the same electrical circuit. Each heater and appliance should be on its own circuit. If you are on the fence about having 2 heaters in a room, we recom-



Questions & Answers

Why does the Blower Fan keep running after I have turned off the unit?

The Blower Fan will continue to run until the heat chamber has cooled down. After a few minutes the fan will shut off automatically. This ensures that the quartz infrared heating elements are cooled properly helping to ensure the longevity of your heater.

Can the heating elements be replaced?

Yes. Contact an authorized repair center, generally, this is the store where you purchased your heater. If you ordered the heater online or have had the heater for longer than one year, contact customer service to order replacement elements.

My cord is getting very hot, especially at the plug. Is that normal?

No. Most likely the problem is that the connection from the wall wiring to the outlet is faulty and is causing the outlet and plug to overheat. Also, make sure there are not too many appliances plugged into outlets on a single circuit. This problem is quite common in older homes. If the problems persist consult a qualified electrician.

The heater's airflow seems to have diminished?

Make sure the air inlet is not blocked and that the filter is clean. For directions on how to clean the filters, see the Washable Lifetime Filter System in the operations & Controls section of the manual.

Once I initially plug the unit in and turn it on, how long will it take to heat my room?

Generally, it takes about a half hour. Please remember that with any type of heating process there are many variables; size of the room, how well the room is insulated, how many doors/windows, how much bare concrete (which acts as a heat sink with any type of heating), the opening and closing of an exterior door, etcetera. Therefore, heating performance will vary in every environment.

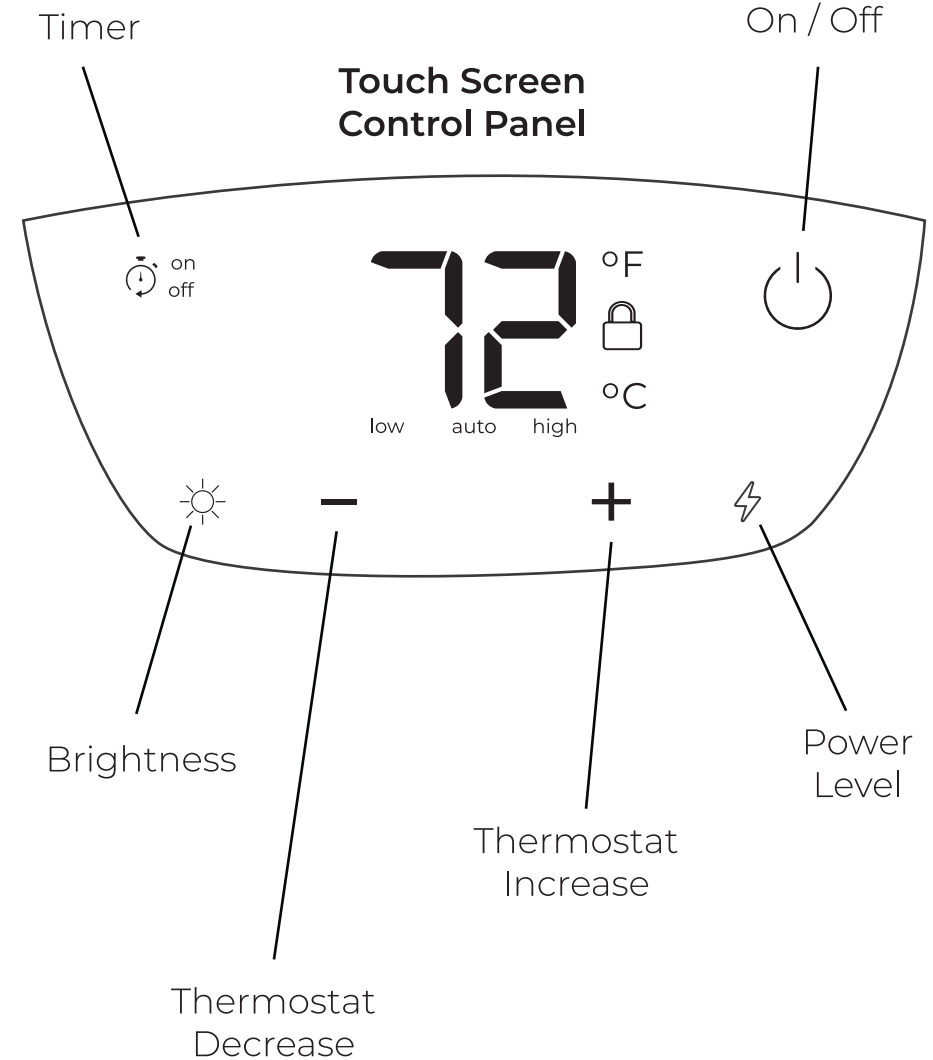

SELECTING CELSIUS AND FAHRENHEIT

By pressing the “+” and “-” icons at the same time, you can set the heater to function and display in Celsius or Fahrenheit.

NOTE: Switching between Celsius and Fahrenheit can only be performed using touch screen on heater, and is not available using the remote control.

SETTING THE TEMPERATURE

When pressing either the “+” or “-” icons the display will enter into temperature setting mode. The heater will indicate that it is in this mode when the numbers begin to blink. Pressing the “+” or “-” icons will change the thermostat by 1 °F or 1 °C.

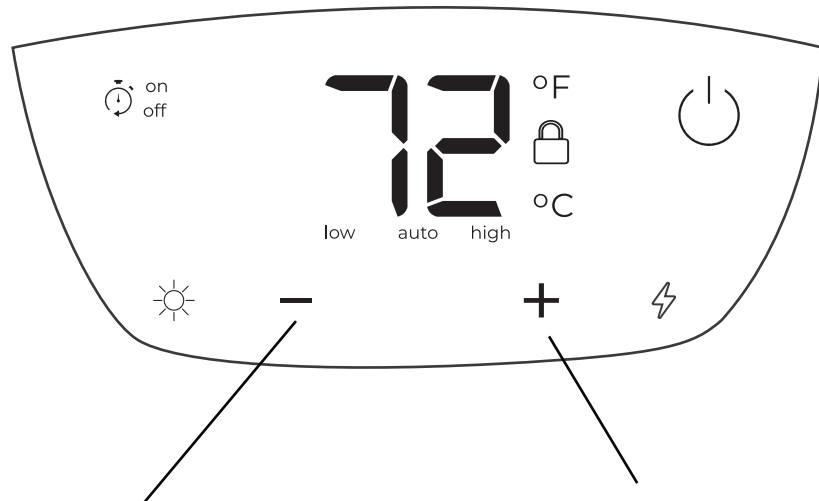

Press this icon to decrease thermostat temperature

Press this icon to increase thermostat temperature

Installing the heater near objects may cause the air in your room not to circulate and therefore have widely varying temperatures within the same room.

- Disconnect the unit from the wall outlet for 2 hours. After 2 hours, plug the unit back into the wall outlet. If the problem persists call customer service at 435-752-6611.

The fan clicks on and runs for under a minute and then turns off. Why?

- The fan is turning on to attempt to create air flow within your room. The heater is trying to determine if the ambient temperature in the room has changed.

My heater smells like burning plastic.

- When you first receive your heater, a light plastic odor is normal. The heater is brand new and has never been used before. If the smell persists for more than a couple of hours, call customer service at 435-752-6611.

My heater is not showing the temperature, just an error code.

"EE" : The temperature sensor (probe) error, when this code shows, the heating element and fan are turned off. Heater needs to be unplugged and check the temperature sensor which could be loose or disconnected or damaged.

"EO" : Program can not set up to run, Heater needs to be unplugged and plugged in again. If this error is still there after several tries, The PCBA need to be replaced.

"E1" This is a heater tilt-over error. When this code shows, the heater and fan are turned off. The heater can be turned back on again by touching on/off icon after heater is standing up again.

"UH" Incorrect high voltage power supply error. The heater must be unplugged immediately.

LO - The temperature is less than 16°F (-9 °C)

HI - The temperature is greater than 99°F (37°C)

- Unplug the heater for 2 hours, then plug the heater back in.
- Do the factory reset. If the error persists, call customer service.



Troubleshooting Guide

When I power the heater ON, it doesn't blow any air at first.

The heater is functioning as it should. The first 15 seconds allows the infrared elements to get hot so that when the fan turns on it moves warm air into the room.

The heater's ambient temperature reading does not match my central heating thermostat reading. Why?

All thermostats vary in their temperature setting. In most cases, the central heating thermostat is not as accurate as your Heat Storm thermostat.

- Also, where the temperature sensor is can alter the thermostat reading.
- You can calibrate your heater's thermostat to match your central heating thermostat. Please see the calibration section of the manual.

The heater keeps blowing air when heater is turned off. Why?

The heater is functioning as it should. This is the cool down phase. The heater will run for several minutes (up to 12) to cool down the internal components. This increases the lifespan of the infrared elements.

The heater is not blowing warm air.

- Check to see if the air inlet is blocked or the air filter is dirty. If the filter is dirty, clean it.
- The ambient temperature (displayed) is higher than the thermostat setting.
- There is something blocking the air flow. Move the object out of the way of the heater. This is common if the heater is in a closet or under a desk.

- The default set temperature of the heater is 70 °F or 21 °C.

- After 5 seconds without control input the display will exit temperature setting mode and show the current ambient temperature.

NOTE: After the heater function or power is shutoff the blower will continue to run for several minutes to cool the internal components.

CHILD LOCK FEATURE

Press the ON/OFF icon for 5 seconds to engage child lock.

When the child lock is on, no changes can be made to the settings until the child lock is turned off.

NOTE: Setting the child lock feature can only be performed using the Control Panel on the heater, and is not available using the remote control.

THERMOSTAT CALIBRATION

Thermostat readings can vary based on the environment. If desired, the thermostat on the heater can be manually calibrated to match central HVAC system.

NOTE: Thermostat calibration can only be performed using the Control Panel on the heater and is not available using the remote control.

NOTE: Typically Heat Storm Infrared Heater thermostats are more accurate than home central thermostats. Changing your Heat Storm Infrared Heater to match your central system may reduce its efficiency.

NOTE: You may have to attempt thermostat calibration several times to make your heater thermostat match your HVAC system.

1. Press the ON/OFF icon down for 10 seconds to begin calibration. After 5 seconds, you will hear a beep indicating that the child lock is on. Continue to hold the ON/OFF icon down until you hear the second beep. Release the ON/OFF icon

2. Use the “+” and/or “-” buttons to adjust the thermostat when the numbers begin to flash.

3. After 5 seconds without control input the heater will exit thermostat calibration.

MAINTENANCE

WASHABLE LIFETIME FILTER SYSTEM

Always unplug the heater when it does not use for a long time

Heat Storm™ Infrared Heaters come equipped with a washable lifetime filter which is easy to clean.

We recommend cleaning the filter regularly, about once or month or more as needed. To do this, follow these steps:

- Locate the filters on your unit. The Wall unit has 2 filters, one on each side of the unit.
- Press both tabs to remove the filter cover and remove the filter, noting which side of the filter receives air flow into the heater.
- Run warm tap water over the filter, the opposite direction of air flow, until water runs clear. The filter might excrete some filtered residue, so be cautious not to drip on any stain-able surfaces such as carpeting. You can also soak the filter in water mixed with a small amount of mild dish soap (remember to rinse well with clean water after soaking filter).
- Shake the filter over a sink until excess water is removed and allow it to drip dry completely before reinstalling.
- DO NOT force or attempt to speed the filter drying process by using any alternative methods.
- ENSURE that the filter is completely dry before inserting back into the air inlet and replacing covers.
- Reinstall the filter and replace cover. OR you can clean the filters with your vacuum.

- Using your vacuum wand, gently run it over the filter cover.

Do not remove the cover or the filter if you choose to clean your heater with the vacuum.

WARNING: ANY REQUIRED SERVICE OTHER THAN FILTER MAINTENANCE SHOULD ONLY BE PERFORMED BY AN AUTHORIZED SERVICE REPRESENTATIVE.

FACTORY RESET

Power off heater and allow time for elements to cool. Unplug and plug in heater. Within 3 minutes of plugging in heater, press and hold timer icon for 10 seconds. This will reset heater to factory settings.