

 HEAT STORM®

# User Manual

and Safety Instructions









## Heavy Duty Heater

3000-6000 W | INDOOR

MODEL:  
HS-6000-GC

**SAVE THIS INSTRUCTIONS MANUAL**

## TABLE OF CONTENTS:

	Safety Awareness .....	1
	Introduction.....	2
	Installation Instructions.....	4
	Operations & Controls .....	7
	Troubleshooting Guide .....	12
	Questions & Answers .....	14
	Return Policy .....	16
	1 Year Limited Warranty .....	17

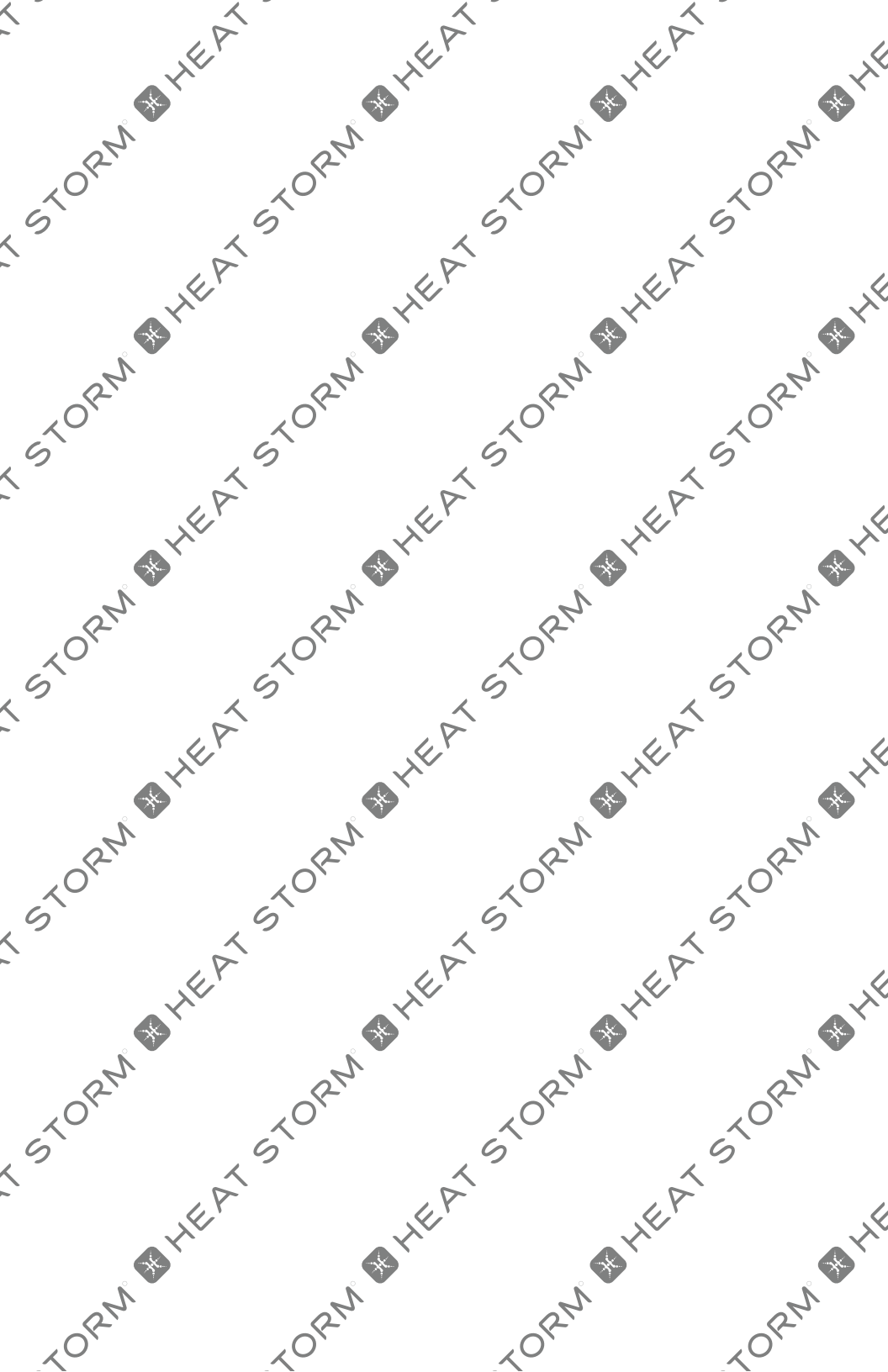



# Safety & Awareness

*Thank you and congratulations on the purchase of your Heat Storm Smart Heater*

**PLEASE READ THIS MANUAL BEFORE OPERATING THIS APPLIANCE.**



WARNING:



*IF THE DIRECTIONS IN THIS MANUAL ARE NOT FOLLOWED, AN ELECTRIC SHOCK OR FIRE MAY RESULT CAUSING PROPERTY DAMAGE, PERSONAL INJURY OR LOSS OF LIFE.*



*DO NOT STORE OR USE GASOLINE OR OTHER FLAMMABLE VAPORS AND LIQUIDS IN THE VICINITY OF THIS OR ANY OTHER HEATING APPLIANCE.*



*ANY REQUIRED SERVICE OTHER THAN FILTER MAINTENANCE SHOULD ONLY BE PERFORMED BY AN AUTHORIZED SERVICE REPRESENTATIVE.*



*Any other repairs attempted by anyone other than an authorized service representative will void the warranty.*



# Introduction

## IMPORTANT INSTRUCTIONS

When using electrical appliances, basic precaution should always be taken including the following:

1. Read all instructions before using this heater.
2. This heater is hot when in use. To avoid burns, do not let bare skin touch hot surfaces. If provided, use handles when moving this heater. Keep combustible materials, such as furniture, pillows, bedding, papers, clothes, and curtains at least 3 feet (0.9 M) from the front of the heater and keep them away from the sides and rear.
3. Extreme caution is necessary when any heater is used by or near children or invalids and whenever the heater is left operating and unattended.
4. Do not operate the heater after the heater malfunctions, has been dropped or damaged in any manner. Return heater to authorized service facility for examination, electrical or mechanical adjustment, or repair.
5. This heater is not intended for use in bathrooms, laundry areas and similar indoor locations. Never locate heater where it may fall into a bathtub or other water container.
6. Do not run cord under carpeting. Do not cover cord with throw rugs, runners, or the like. Arrange cord away from traffic area and where it will not be tripped over.
7. This heater is designed to be directly wired to 240V electric power, Never use with an extension cord or relocatable power outlet
8. Do not insert or allow foreign objects to enter any ventilation or exhaust opening the heater as this may cause an electric shock or fire, or damage.

9. To prevent a possible fire, do not block air intakes or exhaust in any manner. Do not use on soft surfaces, like a bed, where openings may become blocked.
10. A heater has hot and arcing or sparking parts inside. Do not use it in areas where gasoline, paint, or flammable liquids are used or stored.
11. Use this heater only as described in this manual. Any other use not recommended by the manufacturer may cause fire, electric shock, or injury to persons. injury to persons.

**SAVE THESE INSTRUCTIONS**



# Installation & Instructions

## PRECAUTION:

- Installation should always be carried out by a qualified electrician or a competent person.
- The energy supply must be done through a properly grounded power block
- The heaters should always only use the mounting brackets provided.
- The heater should not be facing the ceiling or flammable substances.
- Do not use the heater directly near a bathtub, a shower, a swimming pool.
- Ensure that there is no possibility of flammable material coming into contact with the heater, or lies near the heater.
- Do not use gasoline or other flammable vapors or liquids, including aerosols cans, in the vicinity of this heater while it is operating, such as hydrogen, acetylene, ammonia, Methane, ethylene, and carbon monoxide or other gases lighter than air.
- The heaters are fitted with safety guards. These are intended only to stop large objects from hitting the emitters. On no account should the heater be operated with the guard removed.
- Ensure the power cable does not touch the reflector

1. Assemble the heater onto ceiling use stud finder and ensure to find wood studs for sturdy installation

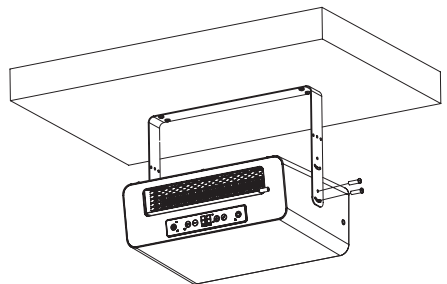
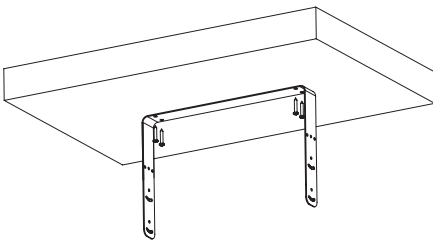

- There are two positions from the ceiling are provided by choosing the installation hole of the handle

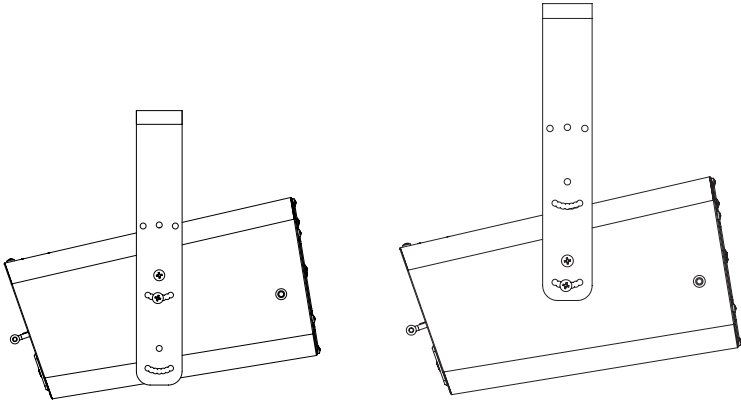

- 3 facing angle can be chosen as followings

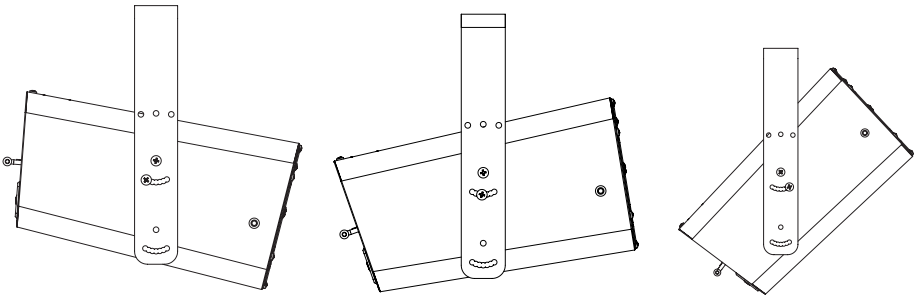

2. Assemble the handle onto wall. Use a stud finder to find wood studs for sturdy installation

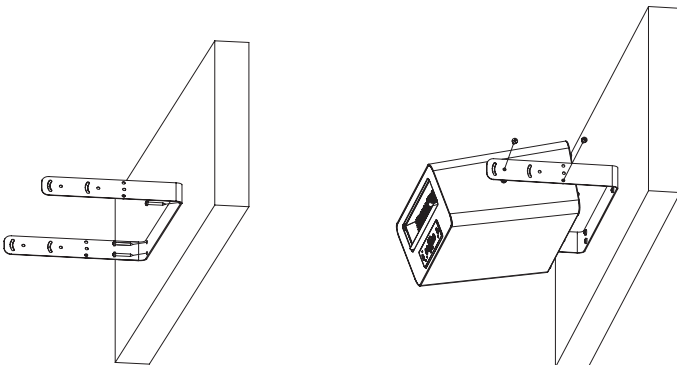



- Different facing angles are available by choosing the holes to fix the handle onto the heater body.

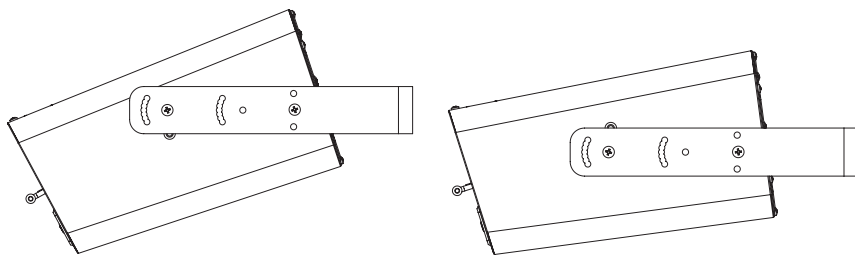

## Connect the power

1. Remove the connecting chamber cover by unscrewing 4 screws

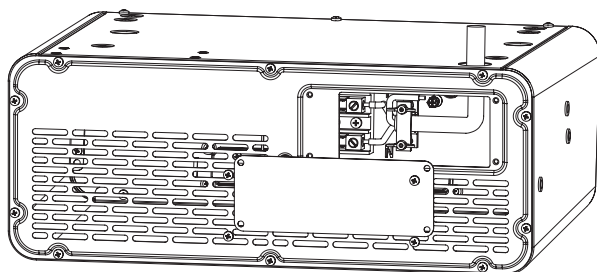



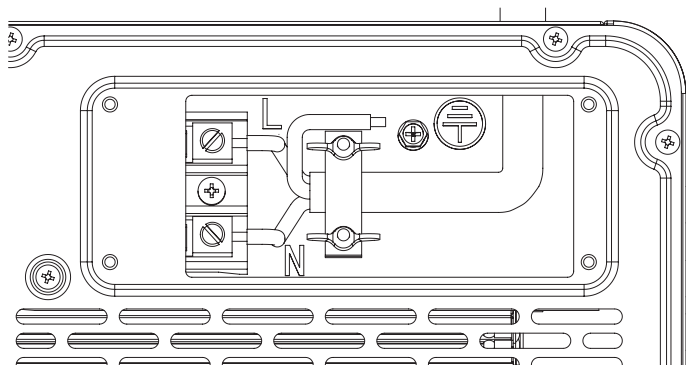



2. Put the cable with 10 gauge internal wires into the chamber through the hole on the top, the cable, connect L, N and Ground and hold by the cable by a clip inside the chamber.





# Operations & Controls



Icon	What you do:	What heater will do:	Function Status:
 Figure 1	Single touch	<b>Turn On/Off the heater</b>	Both Standby and on status
	5 second long touch	<b>Turn On/Off the child lock</b> Press and hold power icon for 5 seconds. You should hear a beep sound. The red lock icon will appear. Press and hold power icon again for 5 seconds to dis-engage.	Both Standby and on status
	10 second long touch	<b>Enter temperature calibration mode:</b> Count to 10 seconds while finger is touching power icon. A beep sound is heard. The temperature number will be flashing. Touch + or – to calibrate the temperature.	On status
 Figure 2	Single touch	<b>Shift working mode from Low-Auto-High-Low</b>	On status
	5 second long touch	<b>Turn on/off beep sound</b>	On status
 Figure 3	Single touch	<b>Touch a single time to increase temperature one degree.</b> Hold for a rapid incremental temperature increase.	Both Standby and On status
 Figure 5	Single touch	<b>Touch a single time to decrease temperature one degree.</b> Hold for a rapid incremental temperature decrease.	Both Standby and On status
	Combo touch	<b>Alternate between Fahrenheit and Celsius.</b>	On status
	Single touch	<b>Change display brightness.</b>	On status
 Figure 4	Single touch	<b>Set delay on and delay off time</b>  <b>Under “standby” status:</b> You can set both delay on and delay off time. Touch the timer icon to enable edit mode. Display will flash. Press + or - symbols to add or take away hours to the “ON” timer.  Single touch icon again to switch to “delay off” mode. Follow same instructions above to add or take away time. Wait 5 seconds for timer settings to activate.  <b>Under “on” status:</b> When heater is on, you can only set “delay off” timer.	Both Standby and On status
	10 second long touch	<b>Factory Reset:</b> Only works within 3 minutes after plugging in.	Both Standby and on status

## Connecting to WIFI



1

Connect to your phone to a 2.4 GHz wifi network.

\*For some dual band routers, you may need to manually create a network dedicated to 2.4 GHz.



2

Download the Smart Life App and create a free account.

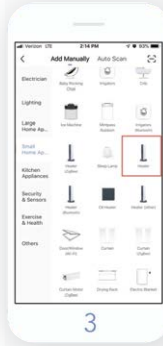

3

Tap "Add Device" then tap "Small Home Appliance" then tap "Heater"

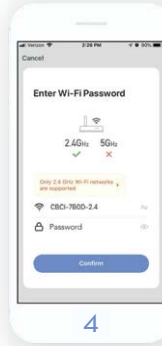

4

Enter in your wifi network name and password. Each of these fields are case sensitive so be sure to double check each one. Then tap "Confirm"

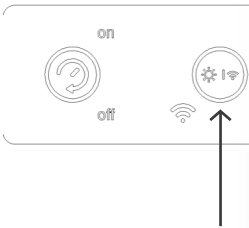

While the heater is plugged in and turned on, press and hold the wifi/sun symbol on control screen for 5 seconds. You should hear a beep and see a wifi symbol start blinking in a blue color

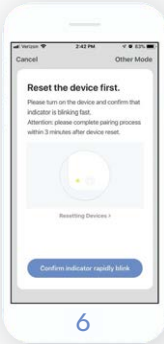

6

Now you can tap "Confirm Indicator Rapidly Blink" icon in the smart life app on your phone or tablet.



7

Your phone will start connecting your heater to your wifi network. Hang tight, it may take a few minutes.



8

Your screen should look like this: If it shows any error notifications, check out our wifi trouble shooting guide online.



9

You can now rename your heater to match the room it is in.

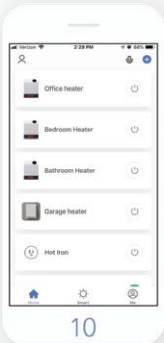

10

You can also connect multiple heaters for all the cold spots in your house and garage!



11

Now you can control your heater with your phone from anywhere! You can adjust temperatures, create schedules, set a child lock and stay warm with a tap of your finger!

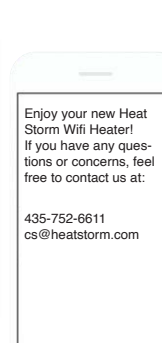

12

Enjoy your new Heat Storm Wifi Heater!  
If you have any questions or concerns, feel free to contact us at:

435-752-6611  
cs@heatstorm.com

# CONNECTING TO WIFI WITH AP MODE

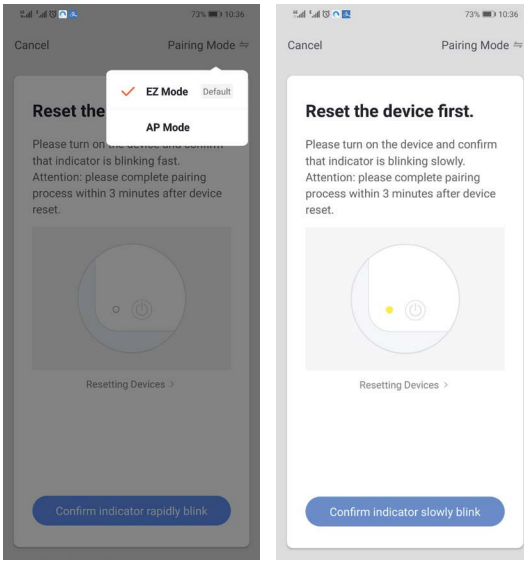

If connection fails with regular mode, the wifi light will automatically enter into AP mode and wifi icon will start blinking slowly.

You can also enter into AP mode by pressing and holding the “wifi/sun” icon for 5 seconds while the blue light is quickly blinking. (The blue light is slowly blinking while the heater is in AP mode.)

Choose “AP pairing mode” in the Smart Life app to connect heater to wifi in secondary AP mode. Follow in-app prompts to connect heater to wifi.

## **SELECTING CELSIUS AND FAHRENHEIT**

By pressing the “+” or “-” icons at the same time, you can set the heater to function and display in Celsius or Fahrenheit.

NOTE: Switching between Celsius and Fahrenheit can only be performed using touchscreen on heater or the Smart Life app on Wi-Fi models and is not available using the remote control.

## **SETTING THE TEMPERATURE**

When pressing either the “+” or “-” icons the display will enter into temperature setting mode. The heater will indicate that it is in this mode when the numbers begin to blink. Pressing the “+” or “-” icons will change the thermostat by 1°F or 1°C.

- The default set temperature of the heater is 70° F or 21° C.
- After 5 seconds without control input the display will exit temperature setting mode and show the current ambient temperature.

NOTE: After the heater function or power is shut off the blower will continue to run for several minutes to cool the internal components.

## **CHILD LOCK FEATURE**

Press the ON/OFF icon for 5 seconds to engage child lock.

When the child lock is on, no changes can be made to the settings until the child lock is turned off.

NOTE: Child lock feature can only be performed using the Control Panel on the heater or through the Smart Life app on Wi-Fi models, and is not available using the remote control.

## **THERMOSTAT CALIBRATION**

Thermostat readings can vary based on the environment. If desired, the thermostat on the heater can be manually calibrated to match the central HVAC system.

NOTE: Thermostat calibration can only be performed using the Control Panel on the heater and is not available using the remote control.

## **WARNING:**

- Before cleaning, unplug from the power supply and wait a few minutes to cool down.
- This heater contains no moving parts, it needs very little maintenance. However, when the heater builds up heavy dirt, use a soft cloth to wipe it off.

## **HEATING ELEMENT REPLACEMENT**

If the heating element malfunctions and needs to be replaced, it should only be changed by a service agent.

## **FACTORY RESET**

Power off heater and allow time for elements to cool. Unplug and plug in heater. Within 3 minutes of plugging in heater, press and hold timer icon for 10 seconds. This will reset heater to factory settings.



# Troubleshooting Guide

## **When I power the heater ON, it doesn't blow any air at first.**

The heater is functioning as it should. The first 15 seconds allow the infrared elements to get hot so that when the fan turns on it moves warm air into the room.

## **The heater's ambient temperature reading does not match my central heating thermostat reading. Why?**

Thermostats vary in their temperature setting. In most cases, the central heating thermostat is not as accurate as your Heat Storm thermostat.

- Also, where the temperature sensor is can alter the thermostat reading.
- You can calibrate your heaters thermostat to match your central heating thermostat. Please see the calibration section of the manual.

## **The heater keeps blowing air when the heater is turned off. Why?**

The heater is functioning as it should. This is the cool down phase. The heater will run for several minutes (up to 12) to cool down the internal components. This increases the lifespan of the infrared elements.

## **The heater is not blowing warm air.**

- Check to see if the air inlet is blocked or the air filter is dirty. If the filter is dirty, clean it.
- The ambient temperature (displayed) is higher than the thermostat setting.
- There is something blocking the airflow. Move the object out-of-the-way of the heater. This is common if the heater is in a closet or under a desk.

Installing the heater near objects may cause the air in your room not to circulate and therefore have widely varying temperatures within the same room.

- Disconnect the unit from the wall outlet for 2 hours. After 2 hours, plug the unit back into the wall outlet. If the problem persists call customer service at 435-752-6611.

**The fan clicks on and runs for under a minute and then turns off. Why?**

- The fan is turning on to attempt to create airflow within your room. The heater is trying to determine if the ambient temperature in the room has changed.

**My heater smells like burning plastic.**

- When you first receive your heater, a light plastic odor is normal. The heater is brand new and has never been used before. If the smell persists for more than a couple hours, call customer service at 435-752-6611.

My heater is not showing the temperature, just an error code.

“EE”	The temperature sensor (probe) error, when this code shows, the heating element and fan are turned off. Heater needs to be unplugged and check the temperature sensor which could be loose or disconnected or damaged.
“EO”	Program cannot set up to run, heater needs to be unplugged and plugged in again. If this air is still there after several tries, the PCBA needs to be replaced.
LO	The temperature is less than 16°F (-9° C)
HI	The temperature is greater than 99°F (37° C)

- Unplug the heater for 2 hours, then plug the heater back in.
- Do the factory reset. If the error persists, call customer service.





# Questions & Answers

## **Why does the Blower Fan keep running after I have turned off the unit?**

The Blower Fan will continue to run until the heat chamber has cooled down. After a few minutes the fan will shut off automatically. This ensures that the heating elements are cooled properly hoping to ensure the longevity of your heater.

## **Can the heating elements be replaced?**

Yes. Contact an authorized repair center, generally, this is the store where you purchased your heater. If you ordered the heater online or have had the heater for longer than one year, contact customer service to order replacement elements.

## **My cord is getting very hot, especially at the plug. Is that normal?**

No. Most likely the problem is that the connection from the wall wiring for the outlet is faulty and is causing the outlet and plug to overheat. Also make sure there are not too many appliances plugged into outlets on a single circuit. This problem is quite common in older homes. If the problems persist consult a qualified electrician.

## **The heater's airflow seems to have diminished?**

Make sure the air inlet is not blocked and that the filter is clean. For directions on how to clean the filters, see the Washable Lifetime Filter System in the operations and control section of the manual.

## **Once I initially plug the unit in and turn it on, how long will it take to heat my room?**

Generally, it takes about a half hour. Please remember that with any type of heating process there are many variables; size of the room, how well the room is insulated, how many doors/windows, how much bare concrete (which acts as a heat sink with any type of heating), the opening and closing of an exterior door, etc. Therefore, heating performance will vary in every environment.

## **What is Zone Heating?**

Zone heating implies that there are multiple areas in any given home or business where climate is best controlled by heaters that generate and deliver heat in each area or zone AND regulate temperature in each area or zone with its own thermostat. Zone Heating is the opposite of central heating which generally relies on a single thermostat to determine climate control for other areas of the house or business. Central heating also requires ducting to deliver heat, which can cause heat loss throughout the duct system.

## **Can I use this heater as a primary heat source?**

Yes, but the heaters were not designed or advertised for this use. The heater will only be able to heat up about 600 square feet, depending on your insulation. If you are using this heater as a primary heat source and it is constantly running, the heater may not be able to keep up.



# Return Policy

If you purchased the heater directly from EnergyWise Solutions we will refund the total sales amount when merchandise is received:

- 1) In new condition
- 2) Packed in its original manufacturers box and all original packaging material included
- 3) Original manuals and any accessories that came with the item also included.

**Manufacturer Return Policy:**

If you have purchased a product that needs an Exchange, Refund or Warranty claim the buyer will be responsible for all rates/shipping charges after 30 days of the purchase date.



# 1 Year Limited Warranty

## **MODELS: All models and accessories**

The manufacturer warrants this product to be free from manufacturing and material defects for a period of one year from date of purchase, subject to the following conditions and limitations.

1. Install and operate this electric heater in accordance with the installation and operating instructions furnished with the product at all times. Any unauthorized repair, alteration, willful abuse, accident, or misuse of the products shall nullify this warranty.
2. This warranty is non-transferable and it's made to the original owner, provided that the purchase was made through an authorized supplier of the product.
3. The warranty is limited to the repair or replacement of part(s) found to be defective in material or workmanship, provided that such part(s) have been subjected to normal conditions of use and service after said defect is confirmed by the manufacturers inspection.
4. The manufacturer may, at its discretion, fully discharge all obligations with respect to this warranty by refunding the wholesale price of the defective part(s).
5. Any insulation, labor, construction, transportation, or other related costs/expenses arising from defective part(s), repair, replacement, or otherwise of same, will not be covered by this warranty, nor shall the manufacturer assume responsibility for same.
6. The owner/user assumes all other risks, if any, including the risk of any direct, indirect or consequential loss or damage arising out of the use, or inability to use the product, except as provided by law.

7. All other warranties – expressed or implied – with respect to the product, its components, and accessories, or any obligations/liabilities on the part of the manufacturer are hereby expressly excluded.

8. The manufacturer neither assumes nor authorizes any third-party to assume on its behalf, any other liabilities with respect to the sale of the product.

9. The warranties as outlined in this document do not apply to non-accessories used in conjunction with the installation of this product.

10. This warranty gives you specific legal rights, and you may also have other rights which vary from state to state. This warranty is void if:

A) The heater is subjected to prolonged periods of dampness or condensation.

B) Any unauthorized alteration, willful abuse, accident, or misuse of the product.

C) You do not have the original receipt of purchase.

## **IF WARRANTY SERVICE IS NEEDED**

Contact the manufacturer by calling the customer service department at **435-752-6611**. Make sure you have your sales receipt, the location of purchase, and the model of your product.

When you contact customer service, they will attempt to troubleshoot the problem with you over the phone. If troubleshooting does not work, you will be asked to email proof of purchase and a picture of the manufacturer sticker to **cs@heatstorm.com**

If you have had your unit longer than the return policy (30 days), you will be expected to pay for shipping the heater back to us. If you would like to use our discounted shipping rates, please let your customer service representative know.

Please be advised that once we receive your unit, it may take a couple of business days for our technicians to determine if your unit can be fixed. If your unit can be fixed, the technicians will do so. You will only receive a new unit if your heater is not repairable.

# NEED HELP?

---

## WATCH OUR TUTORIALS



[www.youtube.com/heatstorm](http://www.youtube.com/heatstorm)

## CUSTOMER SERVICE



435-752-6611  
[cs@heatstorm.com](mailto:cs@heatstorm.com)

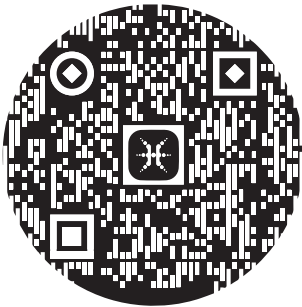



WE WANT YOUR  
**FEEDBACK!**

[www.heatstorm.com](http://www.heatstorm.com)