



Luxury Design Living

by HeatStorm

User and Installation Manual v1.88

For North America

LDL Heating Panel Series Far Infrared Heaters

List of Contents

Item Nr	Description	Page Nr
1.	Scope of Delivery	2
2.	Introduction	2
3.	Safety Instructions	3
4.	Specifications	5
5.	Operating Voltage	8
6.	Installing in a Dropped Ceiling	9
7.	Mounting Instructions	10
8.	LDL Heating Panels' Mounting System	13
9	Typical Domestic Installations – Ceiling vs Wall	14
10.	Correct Placement of the Control Thermostat	16
11.	Using Your LDL Heating Panel	16
12.	Maintaining Your LDL Heating Panel	17
12.1	Cleaning Your LDL Heating Panel	17
12.2	Storing Your LDL Heating Panel	17
13.	Troubleshooting Your LDL Heating Panel	18
13.1	Free Technical Support	18
13.2	Disposal of Unwanted Electrical Goods	18
14.	Saving Energy with LDL's Far Infrared Technology	19
15.	The Advantages of Using LDL Heating Panels	20
16.	Limited International Warranty	21

1. Scope of Delivery

- Heating Panel x 1
- Mounting Brackets kit x 1
- Documentation x 1

2. Introduction

Thank you for choosing one of **LDL by Heat Storm**'s innovative and class-leading IR heating products. It is our intention that you experience many years of satisfaction. This product has been designed and manufactured to the highest quality standards.

LDL by Heat Storm heating products are designed to provide thermal comfort through the use of LDL's proprietary Infra-Red emission technology. Heat in the form of invisible 'light' warms the user directly, without first having to warm up the whole volume of air in the room. This is most efficient when the panels release most of their heat as Infra-Red, and as little as possible by convection. Consequently, they are best installed on ceilings.

LDL's products emit IR in the safe and beneficial Far-IR end of the spectrum
– see page 19 for more information.

Dust agitation and mold/mildew formation in the living space is minimized, whilst the occupant feels

warm in a room with a lower temperature setting (66.5°F or 19.2°C) than with a conventional heating system. It is this lower temperature setting that is the primary energy saving when using IR heating.

Note – The dimensions and flatness of these heating panels are subject to change when at operating temperature. It is also possible the panels make faint sounds as they heat or cool. This is normal and not a concern.

WARNING – The LDL Heating Panel is not designed for use as a clothes dryer. Do not cover the heating panel with any clothing, towels (wet or dry), rugs, curtains etc. These flammable items will impair the correct operation of the heating panel and might lead to overheating of the panel and fire. See the following section for guidance on the safe use of this heating panel.

The information in the following sections is designed to help you in determining how best to install and use LDL by Heat Storm's products in your home, office, or workspace.

3. Safety Instructions

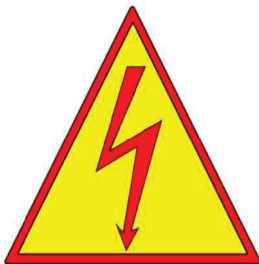

CAUTION!

**RISK OF ELECTRIC SHOCK - DO NOT
OPEN - NO USER SERVICEABLE PARTS
INSIDE**



**WARNING - IN ORDER TO AVOID
OVERHEATING, DO NOT COVER THE
HEATER**

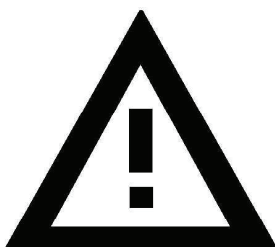

**WARNING - TO REDUCE THE RISK OF
FIRE & INJURY FOLLOW THE
INSTRUCTIONS BELOW**

IMPORTANT INSTRUCTIONS

When using electrical appliances, the following precautions should always be followed to reduce the risk of fire, electric shock, and injury to persons:

1. Read all instructions before using this heater.
2. **THIS HEATER IS HOT WHEN IN USE!** To avoid burns, do not let bare skin touch hot surfaces. Keep combustible materials, such as furniture, pillows, bedding, papers, clothes, and curtains at least 3 feet (0.9m) from the front of the heater and keep them away from the sides and rear.
3. Do not cover the heater as this might cause the heater to overheat.
4. Do not move this heater when it is hot. Wait at least 30 minutes after unplugging from wall receptacle before moving heater.
5. Extreme caution is necessary when any heater is used by or near children or invalids and when the heater is left operating and unattended.
6. Always unplug the heater when not in use.
7. Do not operate any heater with a damaged supply cord or plug or after the heater malfunctions, or has been dropped or damaged in any manner. Discard heater, or return to authorized service facility for examination and/or repair.
8. Faulty outlet connections or loose plugs can cause the outlet or plug to overheat. Check your heater cord and power plug connections.
9. Heaters draw more current than small appliances. Overheating of the power outlet may occur even if it has not occurred with the use of other small appliances.
10. Always plug heaters directly into a power outlet/receptacle. Never use with an extension cord.
11. Do not use outdoors.
12. This heater is not intended for use in bathrooms, laundry rooms and similar indoor locations. Never locate the heater where it may fall into a bathtub or other water container.
13. Do not run cord under carpeting. Do not cover cord with throw rugs, runners, or similar coverings. Do not route cord under furniture or appliances. Arrange supply cord away from traffic area and where it will not be tripped over.
14. To disconnect the heater, press main switch to the 'off' position, then remove plug from outlet.
15. Connect to properly grounded power outlets only.
16. Keep the supply cord as straight as possible - do not curl it up.
17. Do not use it in areas where gasoline, paint or flammable liquids are used or stored.
18. Use this heater only as described in this manual. Any other use not recommended by the manufacturer may cause fire, electric shock, or injury to persons.
19. Do not install a higher capacity circuit breaker without consulting a qualified electrician.
20. Please consult a qualified electrician for larger systems to ensure that circuit breakers and RCDs (GFCIs) meet the design criteria of your system.
21. Single heating panel installations may use a plug-in utility power (120VAC) thermostat, which can be purchased from your local hardware/DIY store, or **LDL by Heat Storm** representative.
22. Please consult your electrician or an **LDL by Heat Storm** representative if you have any safety concerns or questions.

23. **SAVE THESE INSTRUCTIONS**

4. Specifications

Electrical

Model ¹	Power ²	Voltage ³	Initial Current ⁴	Average Current ⁵
IHP2424	400W 1360BTU/hr	120VAC 60Hz	4.4A	3.3A
IHP4824	750W 2560BTU/hr	120VAC 60Hz	8.1A	6.3A
IHP4141	1100W 3750BTU/hr	120VAC 60Hz	11.1A	9.2A

¹ **Model** - The model number reflects the panels' nominal sizes in inches. See **Dimensions** below for the precise sizes. The panels are available in matte white (e.g., IHP2424W) as standard with black (e.g., IHP2424B) as an option.

² **Power** - Indicates the typical power at the operating temperature. This can vary slightly due to manufacturing and line voltage tolerances.

³ **Voltage** - Denotes the nominal approved operating voltage and line frequency.

⁴ **Initial Current** - Denotes the maximum current consumed when first powered up. This start-up current decreases as the heater warms up. This current will vary slightly depending on the line voltage. These figures are given to help in choosing circuit breaker sizing.

⁵ **Average Current** - Denotes the average current consumed when the heater is warm. The duty cycle of the heaters is 100% - the heater is generating full power whenever it is on. The panel is designed to self-regulate its surface temperature to $\approx 200^{\circ}\text{F}$ or 90°C . This self-regulation is helped by the natural heat loss (through IR radiation) of the panel surface (high emissivity) and the PTC effect of the custom heating element. That is, as the temperature of the element increases, then so does its electrical resistance which consequently limits the temperature increase.

Dimensions

Model	Size ¹ L x W x H	Weight ²	Mounting Type ³
IHP2424	23.75" x 23.75" x 1.4" (603 x 603 x 35mm)	9 lb. (4kg)	A
IHP4824	47.75" x 23.75" x 1.4" (1213 x 603 x 35mm)	16½ lb. (7.5kg)	B
IHP4141	41.1" x 41.1" x 1.4" (1043 x 1043 x 35mm)	24 lb. (10.9kg)	C

¹ **Size** - Denotes the actual size when cold. At operating temperature these dimensions will vary slightly. The IHP2424 and IHP4824 panels are standardized dimensions designed for dropped or suspended ceiling installations. The IHP4141 panel can be mounted on a ceiling or wall using the special mounting brackets supplied. This panel is not designed for use in a dropped ceiling.

² **Weight** - This value will help in choosing suitable anchor fasteners.

³ **Mounting Type** - "A", "B", and "C" refer to the mounting hole spacing for the brackets. See page 10 for more information.

Rating Class

Model	IP Rating¹	Protection Class²	IR Spectrum³
IHP2424	30	Class I	IR-C 7,980nm
IHP4824	30	Class I	IR-C 7,980nm
IHP4141	30	Class I	IR-C 7,980nm

¹ **IP Rating** - According to the International Protection Rating system, LDL Heating Panels are rated at **IP30**. This means they are mechanically protected against solid objects greater than 2.5mm (0.10") causing harm to the heater but have no protection against water spray. These heating panels are designed for indoor use in non-wetted areas.

² **Protection Class** - The LDL Heating Panels are rated as a **Class I** appliance. This means the aluminum frame is connected to electrical earth (ground). If a live conductor contacts the frame then current will flow through the earth (ground) conductor and will either trip the circuit breaker or the RCD (GFCI) if fitted.

³ **Infrared Spectrum** - The type of IR energy released by the heater panel is classed as being in the Far Infra-Red, Long wavelength Infra-Red, or **IR-C** area of the spectrum, according to the limits defined by the International Commission on Illumination. Referring to Wien's Displacement Law, it can be proven that a body with a surface temperature of 90°C (363 K) emits energy with a wavelength of approximately 8.0 microns. Refer to page 19 for more information.

Environmental Conditions

Model	Max. Ambient Temperature¹	Max. Ambient Humidity (RH)²	Operating Temperature³
IHP2424	104°F (40°C)	85%	194°F (90°C)
IHP4824	104°F (40°C)	85%	194°F (90°C)
IHP4141	104°F (40°C)	85%	194°F (90°C)

- ¹ **Max. Ambient Temperature** - This is the safe maximum temperature of the local environment the heating panel is mounted in.
- ² **Max. Ambient Humidity** - This is the maximum relative humidity in the local environment for the heating panel. These panels are not designed for use in wet or damp environments. Their protection class rating is IP30, which means no exposure to water is permitted.
- ³ **Operating Temperature** - This is the typical surface temperature of the heating panel after it has stabilized. It is not possible to adjust this temperature as it is a consequence of the heating panel design.

5. Operating Voltage

The LDL Heater Panel is designed for use on 120VAC 60Hz and uses a standard Type B (NEMA 5 - 15P) plug for the North American market. See **Figure 5a**.

It features Line (Hot), Neutral and Earth (Ground) pins. Outlets must have a proper ground connection.

The power cord is approximately 6½ feet (2.0m) long and is made from heat and abrasion resistant PVC material.

The plug is molded to the cord and is not user serviceable. If there is any damage or tears in the cord insulation then it must be replaced by a licensed electrician or returned to LDL North America for repair/replacement.

If a legacy 2 pin outlet (NEMA 1-15R) is the only type of receptacle available, then a polarized grounding adapter plug must be used. It is essential that the grounding lug on this adapter plug is screwed to the grounding point on the outlet. As this type of adapter plug is illegal in some jurisdictions (particularly throughout Canada), a safer and more reliable alternative identified in the US and Canadian electrical codes is to replace the outlet with a Ground Fault Circuit Interrupter (GFCI) breaker outlet.

The cord has a plug as shown at (A) in **Figure 5b**. An adapter as shown at (C) is available for connecting three-blade grounding-type plugs to two-slot receptacles. The green grounding lug extending from the adapter must be connected to a permanent ground such as a properly grounded outlet box. The adapter should not be used if a three-slot grounded receptacle is available.

For enhanced security it is recommended to install an RCD (Residual Current Device) or GFCI (preferably with a 30mA tripping point) in the electrical circuit. This will protect the user if there is current leakage to earth.

The cord comes with an ON/OFF switch shown on Figure 5c

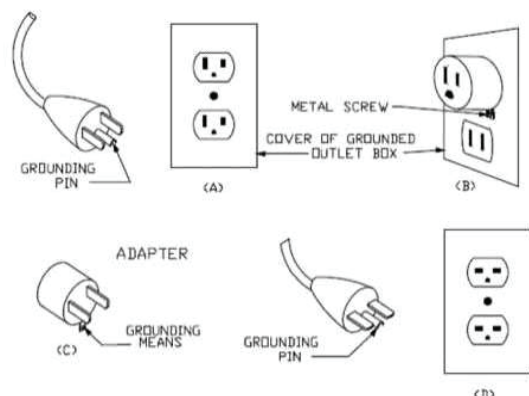

Figure 5c - ON/OFF Switch

**Figure 5a
Type B Plug (NEMA 5 - 15P)**



Figure 5b – Grounding Adapter Plug



6. Installing in a Dropped Ceiling

In buildings with a suspended or dropped ceiling grid, the panels (HS-2424-AL and HS-2448-AL) may be placed in the ceiling's grid.

They are sized to fit into standard suspended ceiling apertures. These ceiling grids are available in a 24" square format for small rooms or in 48" x 24" size for larger spaces.

The HS-2424-AL panel is exactly 23.75" x 23.75" and will fit into the grid and be supported by the main runner (T bar) and cross tee. The IHP4824 panel is exactly 47.75" x 23.75" and will be uniformly supported by the runner design of a typical dropped ceiling structure. See **Figure 6a**.

Mounting the heating panel in a dropped ceiling is easy as can be seen from **Figure 6b** on the right.

To reduce heat losses in installations with a large open space above the ceiling panels, fiberglass (or similar non-conductive) insulation capable of withstanding temperatures of at least 200°F (or about 90°C) may be used to cover the back of the unit.

Figure 6a – Close-up of T Bar Support

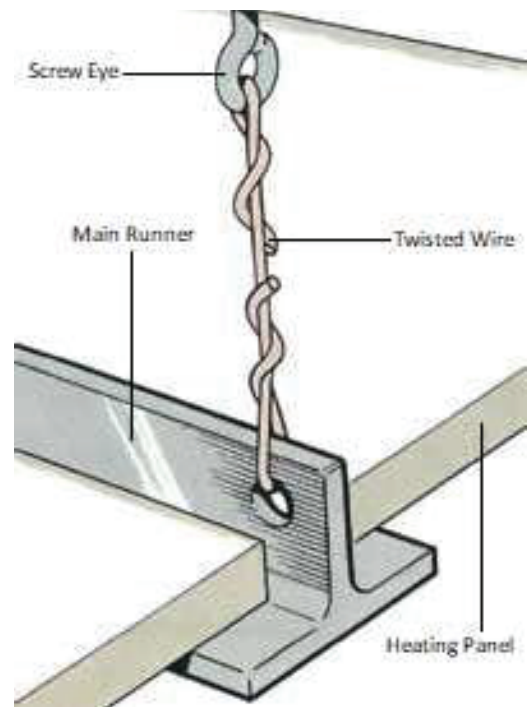
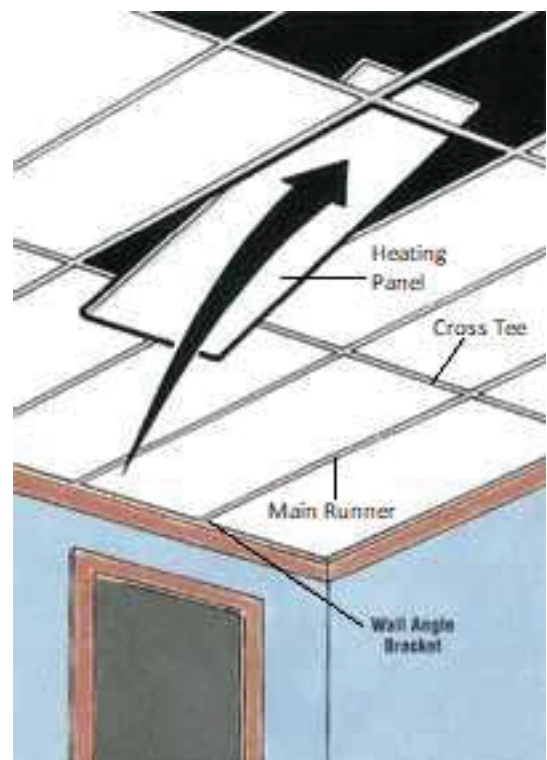

Figure 6b – Placing in Ceiling Grid



7. Mounting Instructions

Owing to the relatively low operating temperatures, there are no minimum mounting height requirements. The units may be placed at any practical height and may be mounted horizontally, vertically or at any desired angle to blend in with the room's décor. Ceiling mounting is best for efficiency as there is virtually no convection. Each panel size has a pair of mounting brackets supplied when purchased. These brackets are not required for suspended ceiling installations – see page 9. When wall mounting it is recommended to use these brackets. Type "A" brackets are for the HS-2424-AL panel, type "B" brackets are for the HS-2448-AL, and type "C" brackets are for the HS-4141-AL panel.

Mounting Bracket Dimensions "A" HS-2424-AL

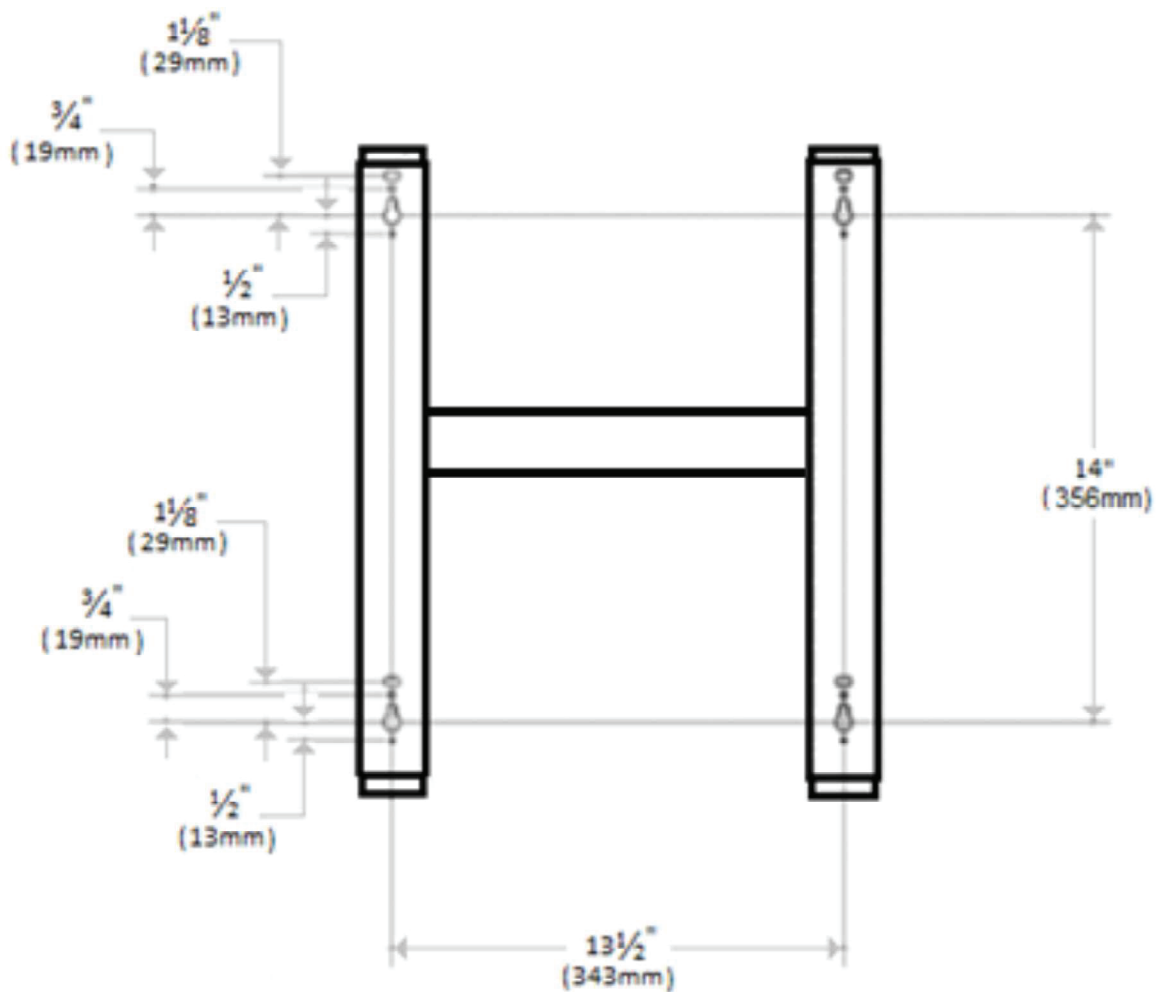

- ◆ The LDL Heating Panel model 2424 is fitted with a safety latch mechanism that replaces the need to use safety screws or security wire in wall and "on-ceiling" installations. Owing to the design of the safety latch mechanism, the heaters can be removed from the mounting brackets without the need of tools.
- ◆ The brackets may be mounted on the wall or ceiling.
- ◆ For the IHP2424, the primary fastener (hole) pattern is 13½" x 14" (343mm x 356mm). Please observe the 13½" (343mm) dimension as it is critical for proper bracket insertion.
- ◆ The power supply cable may exit over the edges, or through the mounting bracket opening.

Mounting Bracket Dimensions “B” HS-2448-AL

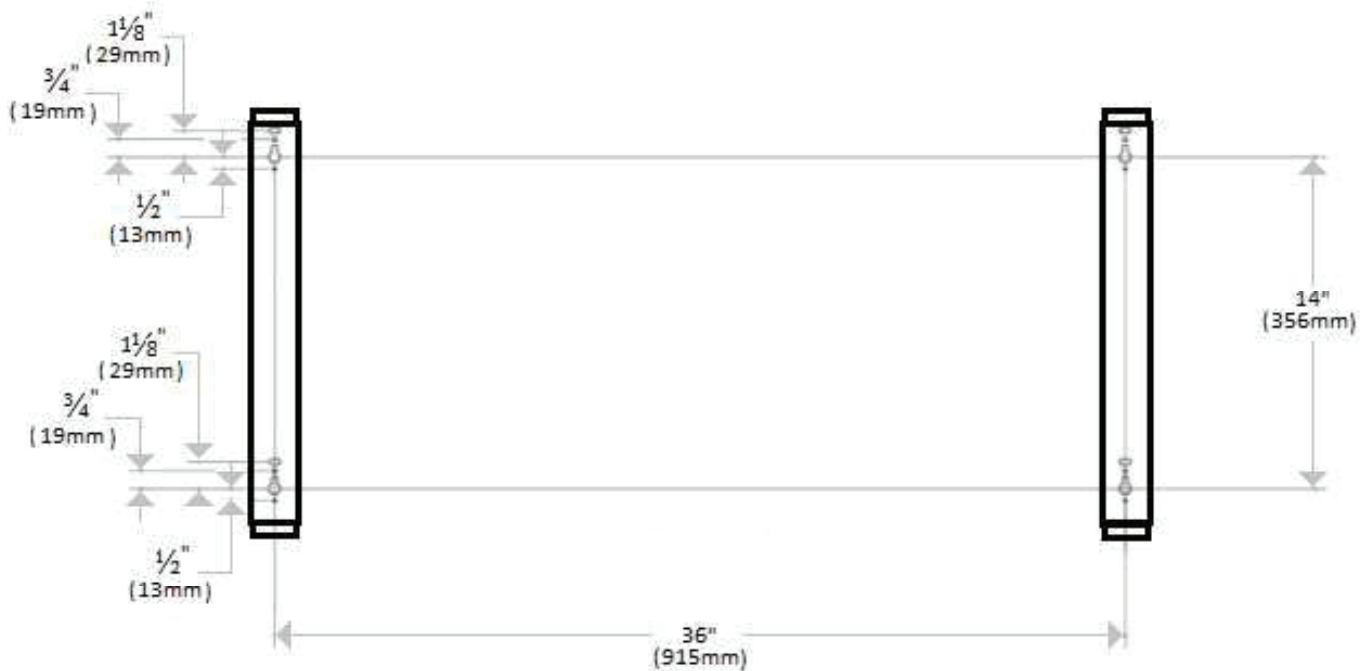

- ◆ The LDL Heating Panel model 4824 is fitted with a safety latch mechanism that replaces the need to use safety screws or security wire in wall and “on-ceiling” installations. Owing to the design of the safety latch mechanism, the heaters can be removed from the mounting brackets without the need of tools.
- ◆ The brackets may be mounted on the wall or ceiling.
- ◆ For the IHP4824, the primary fastener (hole) pattern is 36” x 14” (915mm x 356mm). Please observe the 36” (915mm) dimension as it is critical for proper bracket insertion.
- ◆ The power supply cable may exit over the edges, or through the mounting bracket opening.

Mounting Bracket Dimensions “C” HS-4141-AL

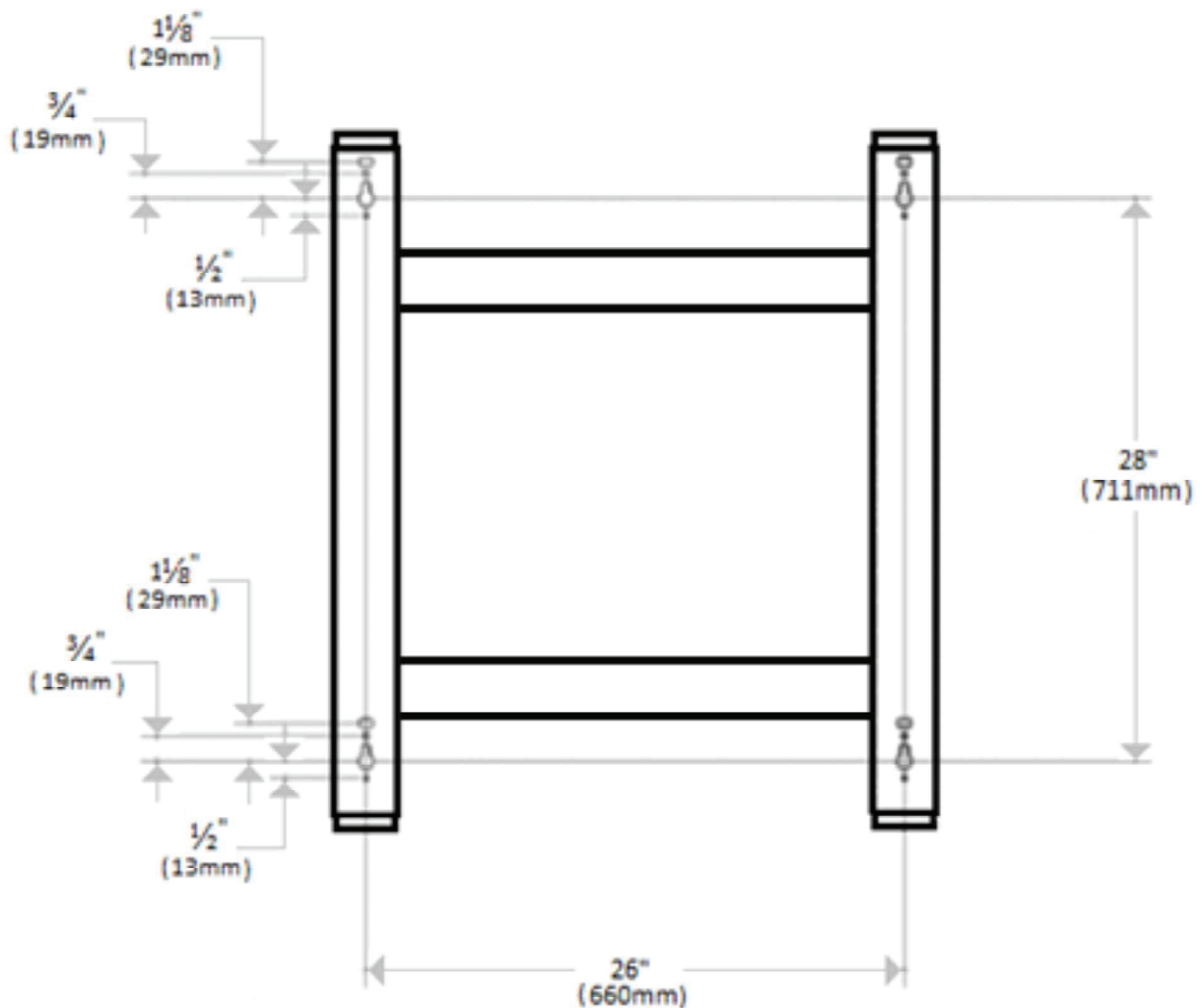

- ◆ The LDL Heating Panel model 4141 is fitted with a safety latch mechanism that replaces the need to use safety screws or security wire in wall and “on-ceiling” installations. Owing to the design of the safety latch mechanism, the heaters can be removed from the mounting brackets without the need of tools.
- ◆ The brackets may be mounted on the wall or ceiling.
- ◆ For the IHP4141, the primary fastener (hole) pattern is 26” x 28” (660mm x 711mm). Please observe the 26” (660mm) dimension as it is critical for proper bracket insertion.
- ◆ The power supply cable may exit over the edges, or through the mounting bracket opening.

8. LDL Heating Panels' Mounting System

Please review the following procedure to install properly an LDL far infrared heating panel. Be sure to space the brackets correctly, observing the notes on “critical dimensions” in the “Mounting Instructions” section of this manual (see pages 10-12).

To install the IHP2424, IHP4824, and IHP4141 models, (mounting sizes A, B, and C), mark the mounting locations using the dimensional information from the previous section and install the mounting brackets (be sure the brackets face the same direction). Where possible (in joist ceilings and/or stud walls) at least one of the brackets' mounting holes should be over a stud or joist. The other(s) should be installed using appropriate anchors. These anchors need to be chosen after reviewing the local mounting requirements. This optional anchor hardware is not included as installations vary by building and region.

Installation:

1. Locate an area near an active power outlet, or employ an electrician to provide a power outlet within 6½ feet (2.0m) of the heating panel.
2. Install the two mounting brackets. Wherever possible utilize the holds which are closest to each end.
3. Using a flat blade screwdriver open the safety latches. See **Figure 8a**.
4. Ensure that the intended power outlet or relevant circuit breaker is switched off.
5. While a helper holds the panel, route the power cord to the outlet. Do not activate the circuit breaker for this circuit until the installation is completed.
6. Plug the power plug into the outlet.
7. Place the panel near the mounting brackets and engage the right-hand (straight) hook. See **Figure 8b**.
8. Slide the panel onto the bracket by holding it gently against the wall or ceiling to engage the left-hand hook.
9. If wall mounted, pull the top of the panel away from the wall and engage the safety latches (use a screwdriver or suitable tool if needed). If ceiling mounted, allow the panel to rest on the brackets, slide it to the latch side and close the safety latches. See **Figure 8c**.
10. Plug in the panel or engage the circuit breaker and test the panel operation.

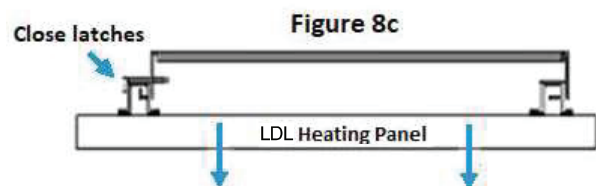
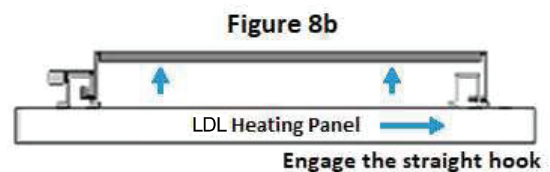
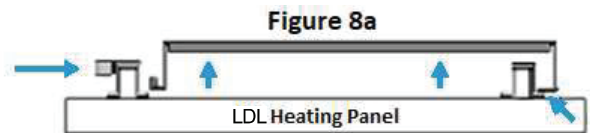

Note: Single person installation is possible by using temporary “s” hooks (obtained locally) in the “boxed hook” (left-hand side) of the mounting bracket and the holes in the reinforcement bars. These hooks replace the helper in step 5 above. These hooks temporarily suspend one end of the panel while the electrical connections are made. To remove the hooks simply shake the panel and the hooks will drop out. Then install the panel as outlined above.

The LDL far infrared heating panels may be suspended from joist or rafters by steel cables or chains in a manner compliant with local building codes. It is not advised to use nylon or polyethylene cord to suspend the panels as these materials are flammable.

When mounting the panels on conventional ceilings local building codes may require additional steel cables, or chains to secure the panels to the rafters or joists above. Wires, cables and/or chains may be secured through the appropriate size holes at the ends of the panel’s mounting brackets.

Please contact your LDL North America representative for further advice on mounting panels, thermostats and/or control systems.

CAUTION! To minimize the risk of fire and to prevent the undesired loss of performance (caused by voltage-drop) do not use extension cords to power the heaters.

9. Typical Domestic Installations – Ceiling vs Wall

Infrared Heating System – Ceiling Mounted *Recommended Set-up*

Figure 9a

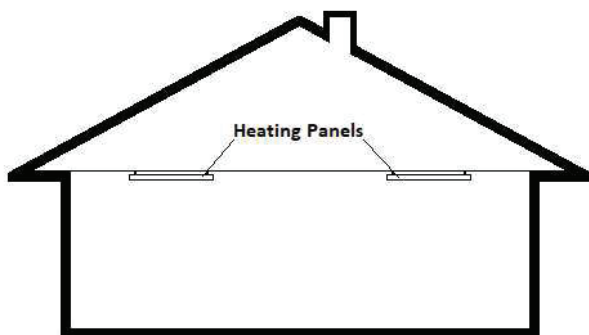
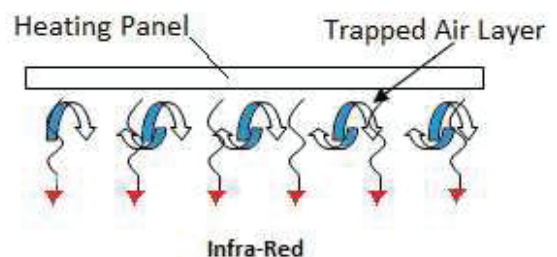

Figure 9b



- IR Panels mounted on ceilings for highest efficiency. The ideal panel installation minimizes convection at the panel, and maximizes Infra-Red emission. Convection depends on the flow of air close to the panel surface, and so the simplest way to minimize it is to use the panel itself as a barrier to air movement – see **Figure 9b**.
- When installed as shown in **Figure 9a** (Horizontal, at ceiling height), the full benefits of the LDL heating panels will be obtained. The layer of trapped air stays close to the panel, and consumes little power.
- Wall mounted panels can lead to greater heat losses to outside walls.
- Independent tests have shown 20% lower heat losses/better efficiency with ceiling mountings.

Figure 9c – Large Room Installation Plan View

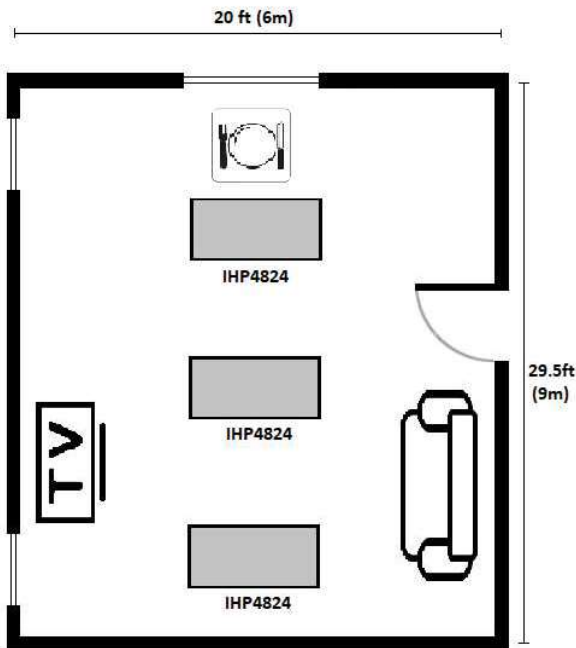
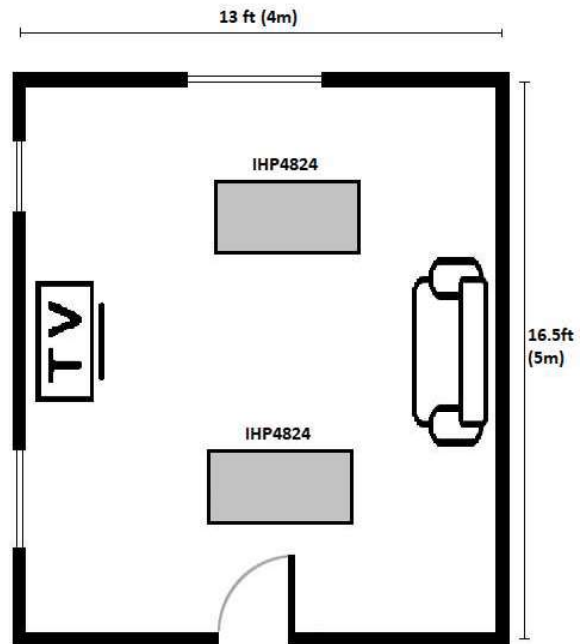

Figure 9d – Small Room Installation Plan View



- In **Figure 9c** above, three heating panels are required as the room area is 581ft² (54m²).
- It is best practice to mount each heater away from the adjacent walls to minimize any undesirable heat losses.

- **Figure 9d** shows a smaller room heat installation of 215ft² (20m²). Note figures are not to scale.
- In this case, two heating panels are necessary to maintain a comfortable heating environment.
- Note the heating panel is placed close to the typical seating area for maximum benefit.

**Infrared Heating System – Wall Mounted
Alternative Set-up**

Figure 9e

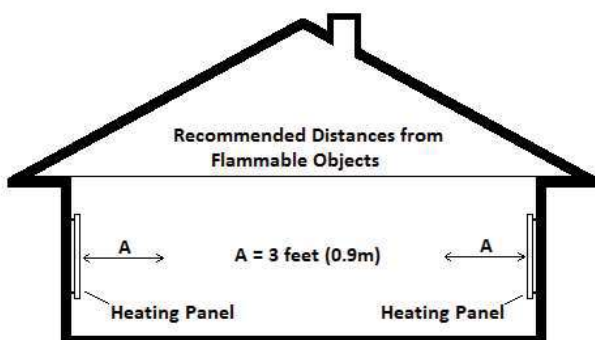
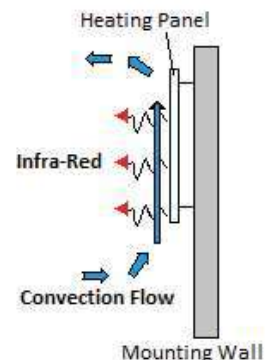

Figure 9f



- **Figure 9e** shows wall mounted heating panels and the recommended distances from flammable objects.
- **WARNING** – Do not cover the heating panels with clothing, towels, rugs, curtains or any such insulating material. This prevents the heating panel from operating correctly and can lead to failure. Such failure is not covered by the limited warranty.
- With wall mounted installations convections losses are increased due to air currents formed in the room. See **Figure 9f** for an illustration of convection air currents formed on vertically mounted panels.

10. Using Your LDL Heating Panel

WARNING – Do not cover the heating panel with any materials such as clothing, rugs, curtains, towels, etc. These products are flammable and covering the heater prevents it from operating correctly and safely. Covering the heating panel is a violation of the limited warranty.

1. After the heater is mounted on a wall or ceiling, plug the cord into the outlet.
2. Locate the main switch and switch to the 'On' position. There are no visible power lights or indicators on the heater. It is possible the heating panel will make sounds as it heats up. This is normal and is no cause for concern. It is due to the expansion of the metal frame.
3. After a short while, the heater surface will rise in temperature and start radiating energy.
4. Eventually it will reach approximately 200°F or 90°C.
5. To switch off the heater it is necessary to move the main switch to the 'Off' position.
6. After approximately 30 minutes, the heater will be at ambient temperature.

11. Maintaining Your LDL Heating Panel

The LDL Heating Panels are maintenance free during normal operation. In dusty conditions, it is possible the heaters will require cleaning. Refer to the cleaning instructions below for the correct procedure.

11.1 Cleaning Your LDL Heating Panel

1. Switch off, unplug the heater from the outlet, and wait 30 minutes to allow the heater to cool down to ambient temperature.
2. After ensuring the heater surface is cool, clean the heater surface using a damp cloth. Do not use any strong detergents when cleaning the heater. Only use a cloth lightly moistened with clean water.
3. Do not spray the heater with water or allow water to enter the heater. Keep all electrical connections dry at all times.
4. Allow the heater surface to dry completely before plugging the cord into an outlet.

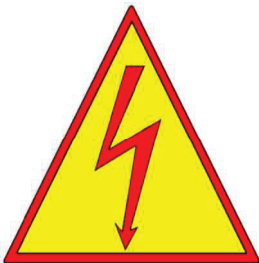

CAUTION!
**RISK OF ELECTRIC SHOCK - DO NOT
 OPEN - NO USER SERVICEABLE PARTS
 INSIDE**

As the LDL Heating Panels are maintenance free it is not required for a user to ever open the heater. The heating panels are secured by rivets to prevent unauthorized opening. No user serviceable parts are contained within. In the event of a failure, please return the heater to a service representative. See the **Return Procedure** on page 21 for more information.

11.2 Storing Your LDL Heating Panel

In normal operation, the heater can be left permanently mounted ready for immediate use. If the heater needs to be removed for storage during the summer period then follow the instructions detailed below.

1. Switch off heater and unplug from outlet. If the heater was in use then wait at least 30 minutes to allow heater to cool. Refer to page 13 for instructions on how to remove the heater from the mounting brackets.
2. Coil power cord no tighter than a diameter of 1 foot (30cm). Use a removable tie to keep coil intact during storage. Do not kink or damage cord.
3. Store the heater in a dry, dust free location and protect it from mechanical damage.
4. Cover the heater with protective sheeting if the storage environment is inclement.
5. Before using the heater again, it is necessary to remove the protective covering and the cord tie.
6. Inspect the heater and its cord for damage from mechanical abrasion or rodent attack.
7. Reinstall the heater on its mounting brackets. Plug in the heater, switch it on, and check it for normal operation.

12. Troubleshooting Your LDL Heating Panel

If you suspect that your heating panel is defective, before returning it to the LDL North America service center, read the operating instructions carefully, and then please follow these instructions.

- a. Unplug the panel, remove it from the mounting brackets and plug it into a known working alternative outlet. Plug it in directly, without any auxiliary thermostat or outlet multipliers/power strips. Ensure the main switch is in the ON position. If the heater panel becomes warm after a short while, the problem is not with your panel, but with the original power outlet.
- b. If there is a doubt about the correct operation of the outlet this can be tested with a lamp or other known good operating device. If the outlet is dead and no other devices work, please check your fuses, or circuit breakers or call an electrician to correct the problem. Circuit breakers may trip if too many appliances are connected to the same circuit; this is not considered an ILO product defect.
- c. If the outlet is OK and you have used an optional room thermostat, please check the settings (make sure it is not switched off). If the fault is determined to be with the thermostat, please contact your thermostat vendor for repair or replacement.

12.1 Free Technical Support

If you experience difficulty during the installation or subsequent use of an LDL North America product, you may contact LDL North America's Technical Support department by phone during CST business hours: **+1(435)-752-6611**. LDL's website information is available in the page footer.

12.2 Disposal of Unwanted Electrical Goods

Eventually all electrical goods need to be replaced and the unwanted items must be disposed of responsibly. E-waste must be disposed of in accordance with EPA guidelines for the USA. The Government of Canada recommends contacting your local municipality for advice on how to dispose of or to recycle e-waste.

LDLNorth America supports the initiative to:

- **Reduce** your generation of e-waste through smart procurement and good maintenance.
- **Reuse** still functioning electrical equipment by donating or selling it to someone who can still use it.
- **Recycle** those products that cannot be repaired. Computer monitors, televisions and other electronic equipment should NOT be disposed of with regular garbage, as this is illegal in California, New York, and other states.