

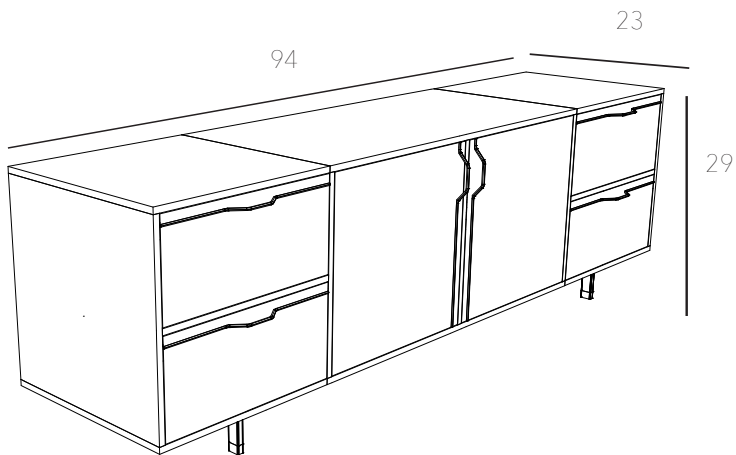

















CHAPMAN 4 UNIT CREDENZA



-  Red (RD)
RAL 3020
-  White (WH)
RAL 9016
-  Black (BL)
RAL 9017
-  Rose'
Copper (CP)
-  Orange (OR)
RAL 2011
-  Yellow (YL)
RAL 1018
-  Green (GN)
RAL 6018
-  Brassy
Gold (GD)
-  Prairie
Green (PG)
-  Pink (PK)
-  Blood
Red (BR)
-  Mustard
Yellow (MU)
-  Walnut
(WAL)
-  Maple
(MPL)
-  Navy (NV)
-  Grey (GY)

3/4" veneer core plywood, powder-coated steel
 storage options: Doors (DO) or Drawers (DW)
 lead time: 3-4 weeks
 sample SKU: CHP_4U_4DW_MPL_CP