

5

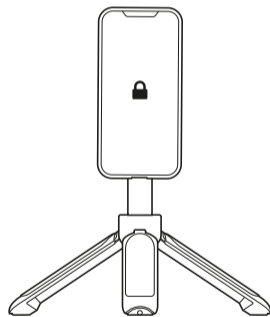

**SP**<sup>TM</sup>  
CONNECT

TRIPOD  
POLE

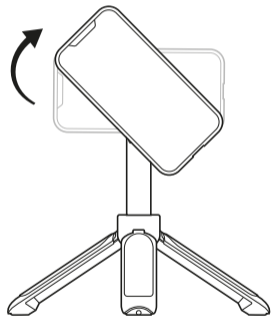
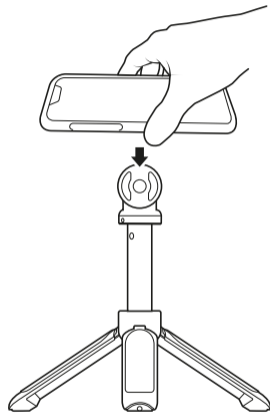

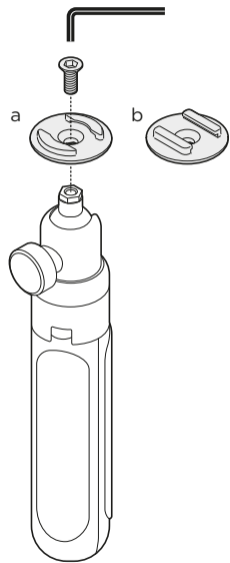
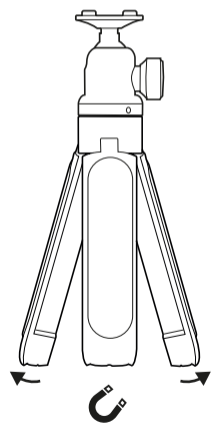
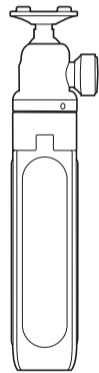
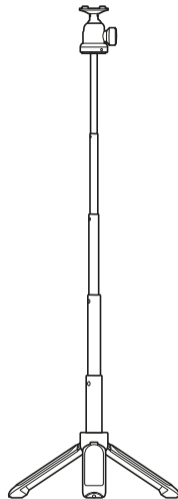
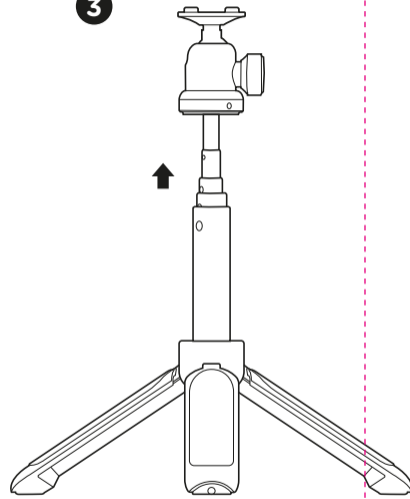
**1****2****3****4**