

4

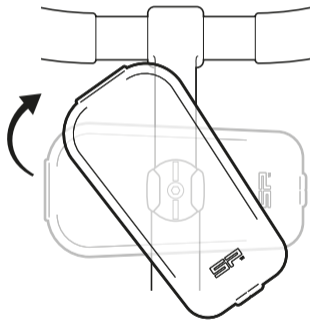

5

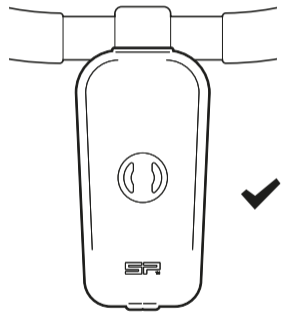

6

**Accessories**  
Zubehör  
Accessoires  
Accesorios

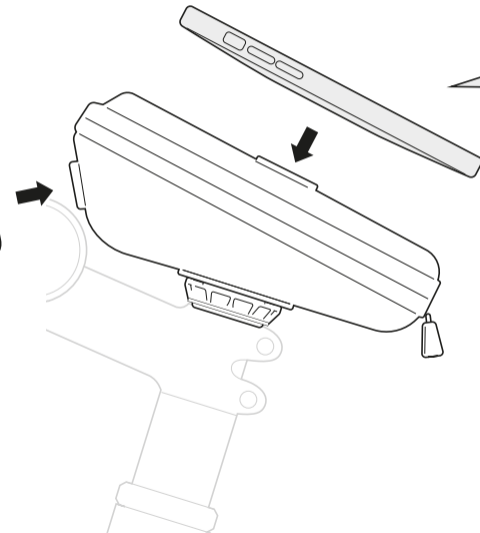
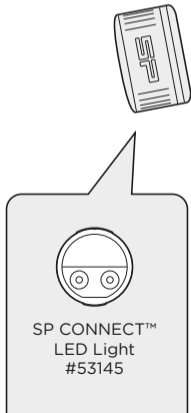

**SP**  
CONNECT

**WEDGE CASE  
SET** 



**1 a** STEM CAP MOUNT

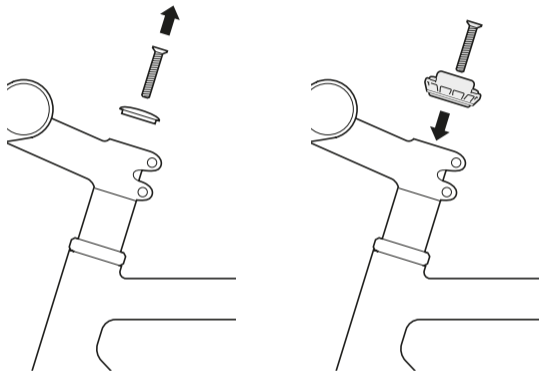

**1 b** CLAMP MOUNT

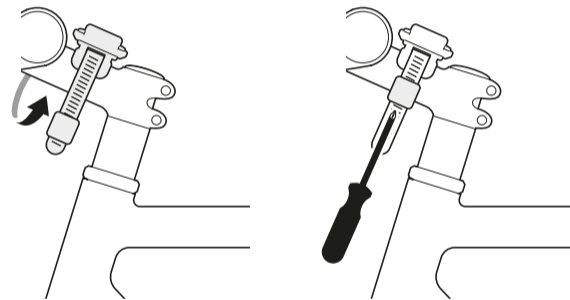

**2**

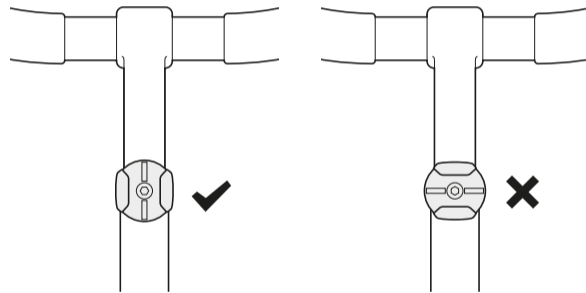

**3**

