



ELECTRIC

FIRES AND STOVES



a warm welcome

It's never been easier to get the warm inviting atmosphere of a real flame fire with all the convenience, versatility and efficiency of electricity.

Using the latest flame-effect technology, Gazco has created a beautiful range of fires and stoves that provide a versatile and stunning focal point for any home – and all without the need for a chimney!

Whether you want to achieve a modern, contemporary look or a more classic, traditional interior, this brochure will help you make the right choice for your home.



Sheraton 5 Electric with Log & Pebble fuel effect and Amber flame setting. Shown with Grafton Limestone mantel





contents

Complete Peace of Mind04

Creative Control05

Radiance Inset Electric Fires..06 - 07

Radiance Inset Edge.....08 - 09

Riva2 670 Electric Fires

Riva2 670 Designio2 10 - 11

Riva2 670 Evoke.....12 - 13

Riva2 670 Verve XS.....14 - 15

Logic2 Electric Fires.....16 - 17

Logic2 Arts 18 - 19

Logic2 Chartwell20 - 21

Logic2 Wave22 - 23

Logic2 Progress24 - 25

Contemporary Electric Stoves

Vogue Midi26 - 27

Vogue Midi T28 - 29

Vision.....30 - 31

Traditional Electric Stoves

Sheraton32 - 33

Stockton.....34 - 35

Marlborough2.....36 - 37

Huntingdon.....38 - 39

Technical Information.....40 - 43

Stove Benches44

eReflex Electric Fires.....46 - 47

Radiance Inset 135R Edge

Main Cover Image: Radiance Inset 105R Edge with Clear Crushed Glass fuel effect.

Top: Vogue Midi T Highline Electric. **Bottom:** Huntingdon 20 Electric with Tracery Door

complete peace of mind

the gazco pedigree

When you choose Gazco, quality and technology are assured. From contemporary hang on the wall fires to traditional stoves, Gazco are committed to creating the ultimate in flame effect fires. Our research and development laboratories are amongst the most advanced in the industry, ensuring that the very latest innovations are incorporated into our products.

Gazco is part of the Stovax Group who offer a prestigious product range which includes everything from traditional to the ultra-contemporary in a wide array of styles and sizes.

Whether your choice is solid fuel, gas, or electric you can be sure to find a stove or fireplace from our range to add the perfect warmth and character to your home. Full details of the Stovax Group's range of products can be found at www.stovax.com.

Gazco is an ISO9001 and ISO14001 accredited company. Our rigorous quality control system ensures that all our appliances are safety checked and that they comply with the appropriate regulations, with all fires in this brochure bearing the CE mark. Similarly, our environmental management systems ensure we work in a sustainable manner, whilst endeavouring to protect the environment by minimising any possible impact from our operations.



warranty information

Your Gazco retailer will provide you with a Two Year Warranty for your new electric fire providing it is registered with Gazco. Please note this warranty excludes certain consumable parts. Fires purchased outside of Gazco's Expert Retailer Network will carry a standard One Year Non-Extendable Warranty. Full warranty details, terms and conditions are available at www.gazco.com.



expert retailer network

We take great care to ensure that our fires are designed, tested and manufactured to the highest possible quality and safety standards. We are just as concerned to make certain that they are sold and installed correctly so that you will enjoy years of pleasure from your purchase.

Accordingly, you will find our products are only available from experienced, independent retailers who will be happy to show you a selection of models locally in their showrooms, often fully operational. These independent retailers will discuss your individual requirements covering both technical issues and design, to ensure that you select the most appropriate product for your home. They will also be able to advise on, or assist with, the installation process as well as help provide any after-sales support and servicing your appliance may require in the future.

Whilst we encourage our retailers to promote fireplace products and their outlets via the internet, we do not believe suitable levels of customer care and satisfaction can be obtained from purchasing the product only online and we would strongly recommend that you consider this when undertaking your research and making a purchasing decision. Furthermore, please be aware that we do not offer technical support (beyond our statutory responsibilities) to products bought via nationwide online sales, where this support would normally be offered by one of our qualified, independent retailers.

In addition, Gazco fires purchased from within our Expert Retailer Network will have the additional benefit of an extended warranty period, subject to terms and conditions. Full details can be found at www.gazco.com.

find your local retailer

You can find your nearest expert retailer by visiting www.gazco.com/find-a-retailer





Logic2 Electric Chartwell with Polished effect front, Polished Steel effect frame, and Log-effect fuel bed on amber flame setting.

creative control

All Gazco electric fires and stoves come with a thermostatic remote control. The sleek handset gives you full control over a host of features, including temperature control as well as flame brightness levels.

flame options

Choose from Amber, Blue** or a combination depending on your mood, with five brightness settings for each colour.

chromalight fuel bed lighting

Choose from 14 different Chromalight LED fuel bed settings on electric stoves*, with 13 vibrant colour choices or a gradually changing spectrum of each.

thermostatic ambient heating

Set the optimum temperature for your room between 15°C and 25°C. The fire or stove will automatically manage heating power to reach the chosen temperature as efficiently as possible.

comfort temperature

Eco and Boost settings allow you to adjust the thermostat by a further +/- 4°C for greater temperature control.

daily and weekly heating

Fires and stoves can be programmed to provide heat at certain times of the day or week, using the handset's Daily and Weekly Timer function.

heating advance mode

Heating cycles can be easily delayed or advanced if desired, without disrupting daily or weekly programming.

adaptive start control

Advanced thermostat technology allows the fire or stove to turn on up to 45 minutes in advance of a scheduled time to ensure the room is at the right temperature, when you want it to be.

open window detection

To save energy, a sudden drop in room temperature of 4°C due to an open window or door will cause the fire or stove to stop heating the room. Heating can be easily resumed by pressing the heat button again or closing the window.

Gazco's energy saving features ensure all models comply with stringent 2018 Ecodesign energy product standards.



*Available on electric stoves only

**Not applicable to Riva2 670 electric models

radiance inset fires

size options

Radiance Inset fires are offered in a choice of three sizes, to suit your interior space. Instantly catching the eye, these breathtaking designer fires will add style and warmth wherever they are installed.

Sizes range from the compact Radiance Inset 85R to the expansive 135R, offering a host of options, whether you're looking to add style to your study or luxury to your lounge. These models can even be fitted into a wallpaper surround, allowing papering to the fire's edge for seamless integration with your home.

	Width	Height
Radiance 85R	901mm	336mm
Radiance 105R	1101mm	336mm
Radiance 135R	1401mm	336mm

* Dimensions given are those overall visible upon installation

fuel effects

All models in the Radiance series come with a customisable fuel bed that provides a focal point even when the fire is off. The standard White and Clear Stone bed can be upgraded to clear Crushed Glass or Glass Beads in either black or clear, to further enhance the flame visuals.



[View the Video](#)

at www.gazco.com/radiance



radiance inset 85R



radiance inset 105R

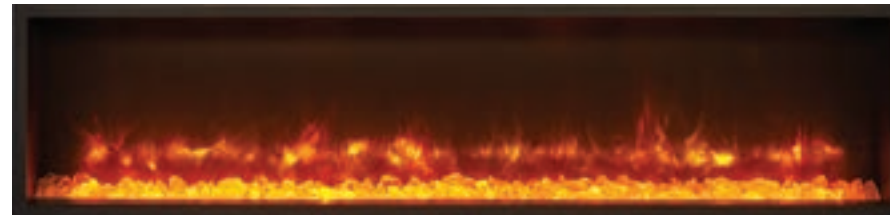

radiance inset 135R

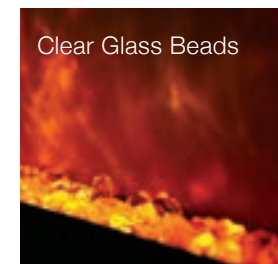
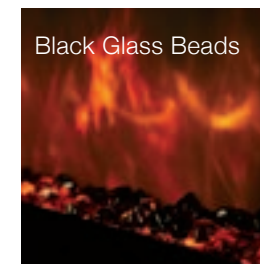
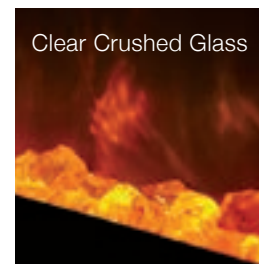



radiance inset edge



Radiance Inset 105R Edge on blue flame setting



Radiance Inset 85R Edge with Clear Glass Beads fuel effect

Presented as the frameless Edge, the Radiance Inset forms a striking hole-in-the-wall focal point - with its flawless lines and pure view of the mesmeric flame effects. The Inset Edge's streamlined design requires only a 180mm pre-constructed cavity for installation, allowing your home's interior to both frame and enhance this ultra-contemporary fire.

See the front cover and pages 3, 7 and 40 for additional images.



View the Video

at www.gazco.com/radiance

Dimensions w x h (mm)*

- Radiance Inset 85R: 901 x 336
- Radiance Inset 105R: 1101 x 336
- Radiance Inset 135R: 1401 x 336

Fuel Bed Options

- White & Clear Stones (Standard)
- Clear Crushed Glass (Upgradeable)
- Black Glass Beads (Upgradeable)
- Clear Glass Beads (Upgradeable)

Heat Output

1.00 - 2.00kW
(or flame effect only)



Programmable
Thermostatic
Eco Remote
Control

* Dimensions given are those overall visible upon installation. For detailed technical information see page 40.

Radiance Inset 135R Edge with
Clear Crushed Glass fuel effect





riva2 670 designio2

Riva2 670 Electric Designio2 Steel in Iridium



Riva2 670 Electric Designio2 Steel in Graphite



The Designio2 Glass and Steel frames offer a selection of contemporary framing options for the Riva2 670 electric fire.

The Designio2 Glass adds striking black glass surround, with glossy reflective surfaces that enhance the fire's luxury aesthetic. For understated style, the Designio2 Steel frames the fire with a sophisticated metal surround, available in either Graphite or Iridium finishes to complement your décor.

Designio2 frames can be either wall or hearth mounted depending on your tastes. Additionally, the Riva2 670 fire itself can also be installed using the optional wall mounting box, for flat wall installation.

Finish
Black Glass
Graphite
Iridium

Fuel Bed
Log effect

Heat Output
1.00 - 2.00kW
(or flame effect only)

**Frame Dimensions
w x h x d (mm)**
735 x 569 x 40*



Programmable
Thermostatic
Eco Remote
Control

* Depth when recessed into wall. For more information on the optional wall-mounting box as well as firebox dimensions, please see page 40.

For information on the remote control features see page 5.

riva2 670 evoke



Riva2 670 Electric Evoke Glass
with White Glass front & Graphite rear



Riva2 670 Electric Evoke Steel
with Graphite front & rear

Minimalist in design but bold in statement, the Evoke frame adds further presence to the Riva2 670. Choose from Steel or Glass fronts to suit your living area.

All Riva2 670 Electric fires can be recessed into a pre-constructed hole for a more minimalist installation but can also be hung directly on the wall with the optional wall-mounting box.

See rear cover for additional image.

Front Finish

Black Glass
White Glass
Graphite

Fuel Bed

Log effect

Heat Output

1.00 - 2.00kW
(or flame effect only)

Frame Dimensions w x h x d (mm)

920 x 622 x 41*



Programmable
Thermostatic
Eco Remote
Control

* Depth when recessed into wall. For more information on the optional wall-mounting box as well as firebox dimensions, please see page 40.

For information on the remote control features see page 5.



Riva2 670 Electric Evoke Glass
with Black Glass front & Graphite rear



riva2 670 verve xs

Riva2 670 Electric Verve XS in Graphite



The stylish Verve XS transforms the Riva2 670 with a 3D frame designed to create maximum visual impact in your home. This subtly curving frame choice comes in smart Graphite to suit a variety of settings.

The Riva2 670's highly realistic fuel bed is enhanced by Gazco's stunning flame-effect, offering the ambiance of a real log flame with the instant convenience of electric.

Finish
Graphite

Fuel Bed
Log effect

Heat Output
1.00 - 2.00kW
(or flame effect only)

**Frame Dimensions
w x h x d (mm)**
1000 x 622 x 41*



Programmable
Thermostatic
Eco Remote
Control

* Depth when recessed into wall. For more information on the optional wall-mounting box as well as firebox dimensions, please see page 40.

For information on the remote control features see page 5.



Logic2 Electric Chartwell with Brushed Steel Effect Frame, Highlight Polished Front and Grey Pebble fuel effect on Amber flame setting. Shown with Claremont Limestone mantel, Stovax Burlington Cast front and Polished Insert Panel.

logic2 electric fires

Featuring advanced LED technology, the Logic2 Electric Inset fire range offers captivating, life-like flame visuals for instant fireside ambience. Designed to fit easily into a standard fireplace opening, 3" rebated mantel with slip or simply against a flat wall using the optional spacer frame, this versatile fire can be enjoyed in almost any interior setting.

The Logic2 features various LED flame effects including deep amber, cool blue or a combination of the two. Using the handset that gives you full control over the fire's features, the Logic2's flames can be set to five brightness settings and can also be displayed with or without the heat if desired.

The Logic2's Programmable Thermostatic Eco handset also offers a number of convenient options, including Daily and Weekly scheduling. This advanced handset also includes various energy saving features which make it Ecodesign compliant. For more information see page 5.



These stylish electric fires come complete with three easily interchangeable fuel beds which each add a unique aesthetic. The log arrangement creates a traditional woodburning look, or, switch to either white and clear stones or grey pebbles for a strikingly contemporary aesthetic.

The versatile Logic2 has a choice of modern and traditionally styled frames and fronts (shown on the following pages) that allow you to customise your fire to suit your home.

three interchangeable fuel effects



Log-effect



White & Clear Stones



Grey Pebbles



Logic2 Electric Wave with Polished Steel Effect Frame, Polished Front and Log-effect fuel bed on Amber flame setting. Shown with White Brompton wooden mantel from Stovax.

Logic2 Electric Arts with Highlight Polished front, Brushed Steel effect frame and White & Clear Stone fuel effect on mixed flame effect setting. Also shown: Art Deco wooden mantel in white, available from Stovax.



logic2 arts



Logic2 Electric Arts with Matt Black front, Brushed Steel effect frame, & White & Clear Stone fuel effect on Blue flame setting. Shown with optional Spacer Frame.

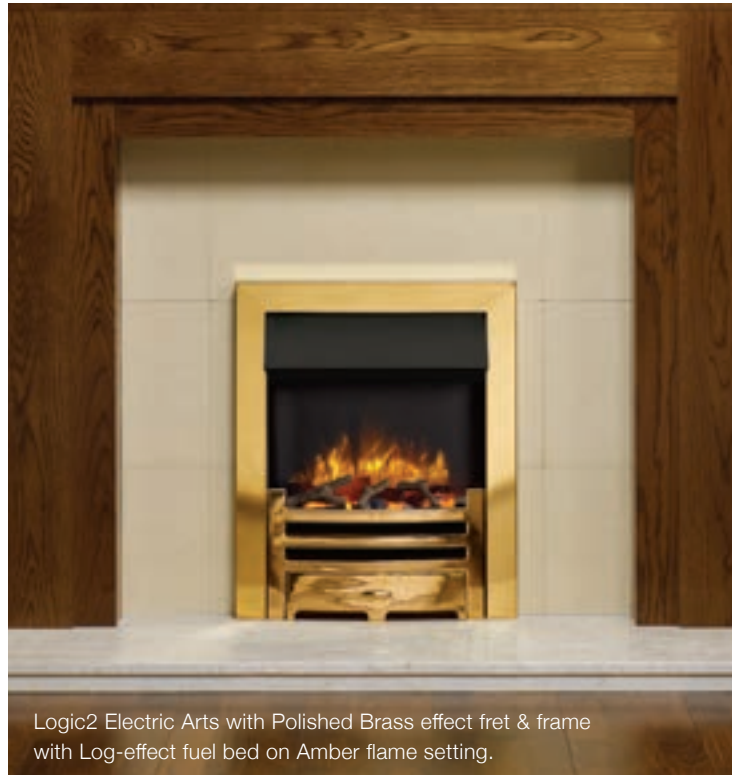

Logic2 Electric Arts with Polished Brass effect fret & frame with Log-effect fuel bed on Amber flame setting.



Logic2 Electric Arts with Polished effect fret, Polished Steel effect frame and Log-effect fuel bed on Amber flame setting.

Taking its design origins from the Arts and Crafts movement in the early twentieth century, the Logic2 Arts embraces simplicity and clean styling. Available in a range of front and frame finishes, the Arts can be selected in a variety of combinations to suit your tastes. Using the optional spacer frame the Arts can also be installed without having to be inset into a wall, minimising building work.

* Dimensions given are those overall visible upon installation. For detailed technical information see page 41.

Finish Combinations

Frame Choice	Front Choice
Matt Black	Matt Black
	Brass effect
	Polished effect
	Highlight Polished
Brass effect	Brass effect
Polished Steel effect	Matt Black
	Polished effect
	Highlight Polished
Brushed Steel effect	Matt Black
	Polished effect
	Highlight Polished

Heat Output

1.00 - 2.00kW
(or flame effect only)

Flame Visual Settings

Amber, Blue or mixed

Interchangeable Fuel Beds

Log-effect
White & Clear Stones
Grey Pebbles

Dimensions w x h (mm)*

510 x 609



Programmable
Thermostatic
Eco Remote
Control

logic2 chartwell



Logic2 Electric Chartwell with Matt Black front and frame, with White & Clear Stone fuel effect on mixed flame effect setting.



Logic2 Electric Chartwell with Polished effect front, Polished Steel effect frame, and Log-effect fuel bed on Blue flame setting.



Logic2 Electric Chartwell with Polished-effect Brass front and frame, with Log-effect fuel bed on Amber flame setting.

The elegant Logic2 Chartwell instantly evokes the heritage and classical styling of a traditional fireplace. Available in various front and frame finishes, the Chartwell can be combined with Gazco's many mantels, fronts and insert panels to create the perfect fireplace for your home.

For easy installation, each frame choice can be used with the optional spacer frame which allows the Logic2 to be fitted directly against a flat wall.

* Dimensions given are those overall visible upon installation. For detailed technical information see page 41.

Finish Combinations

Frame Choice	Front Choice
Matt Black	Matt Black
	Brass effect
	Polished effect
	Highlight Polished
Brass effect	Brass effect
Polished Steel effect	Matt Black
	Polished effect
	Highlight Polished
Brushed Steel effect	Matt Black
	Polished effect
	Highlight Polished

Heat Output

1.00 - 2.00kW
(or flame effect only)

Flame Visual Settings

Amber, Blue or mixed

Interchangeable Fuel Beds

Log-effect
White & Clear Stones
Grey Pebbles

Dimensions w x h (mm)*

510 x 609



Programmable
Thermostatic
Eco Remote
Control



Logic2 Electric Chartwell with Highlight Polished front, Matt Black frame, and Grey Pebble fuel bed on Amber flame setting. Shown with Stovax Malmo wooden mantel.



Logic2 Electric Wave with Polished Steel Effect frame, Matt Black front with Log effect fuel bed on Amber flame setting. Shown with Malmo wooden mantel in White from Stovax.

logic2 wave



Logic2 Electric Wave with Matt Black frame and front with White & Clear Stone fuel bed on Blue flame setting.



Logic2 Electric Wave with Polished Steel Effect frame, Polished effect front with Grey Pebble fuel bed on Amber flame setting.

Blending modern and traditional styling, the Logic2 Wave features smooth lines and refined curves, suiting both contemporary and period interiors alike. The Wave can be selected in Black, Polished Steel, Brushed Steel and Brass with the option to combine different frame and front finishes for unique styling. Logic2 Wave fires are available with an optional spacer frame which allows the fire to be quickly and easily fitted onto a flat wall, if desired.

* Dimensions given are those overall visible upon installation. For detailed technical information see page 41.

Finish Combinations

Frame Choice	Front Choice
Matt Black	Matt Black
	Brass effect
	Polished effect
	Highlight Polished
Brass effect	Brass effect
Polished Steel effect	Matt Black
	Polished effect
	Highlight Polished
Brushed Steel effect	Matt Black
	Polished effect
	Highlight Polished

Heat Output

1.00 - 2.00kW
(or flame effect only)

Flame Visual Settings

Amber, Blue or mixed

Interchangeable Fuel Beds

Log-effect
White & Clear Stones
Grey Pebbles

Dimensions w x h (mm)*

510 x 609



Programmable
Thermostatic
Eco Remote
Control

logic2 progress



Logic2 Electric Progress with Log effect fuel bed on Amber flame setting



Logic2 Electric Progress with White & Clear Stone fuel bed on Blue flame setting.

The ultra-contemporary Progress front's minimalist styling perfectly complements the advanced Logic2 fire. Featuring a smoothly curving front with a striking Iridium finish, this modern fire effortlessly makes for a designer centrepiece in any interior.

The versatile Logic2 fire range is designed to be fitted into a standard fireplace opening or flat against the wall with either a 3" rebated mantel with slip or by using the optional spacer frame.

* Dimensions given are those overall visible upon installation. For detailed technical information see page 41.

Finish

Iridium

Heat Output

1.00 - 2.00kW
(or flame effect only)

Flame Visual Settings

Amber, Blue or mixed

Interchangeable Fuel Beds

Log-effect
White & Clear Stones
Grey Pebbles

Dimensions w x h (mm)*

520 x 602



Programmable
Thermostatic
Eco Remote
Control



Logic2 Electric Progress with Grey Pebble fuel bed on amber flame setting

vogue midi



Vogue Midi Midline Electric with Log & Pebble Fuel effects and Amber & Blue accent flame setting



Vogue Midi Electric with Log & Pebble Fuel effects and Amber flame setting

The Vogue Midi is offered in two models including the taller Midline version, which can be stacked with logs to enhance the wood burner aesthetic. Our Chromalight® Immersive LED technology lets you control flame and ember bed lighting effects to create the perfect ambience in virtually any part of the home, with a choice of fuel effects that can be mixed and matched.

The Vogue Midi is compatible with our range of stove benches, for more information see page 44.

Finish

Matt Black

Heat Output

0.75 - 1.50kW
(or flame effect only)

Flame Visual Settings

Amber, Blue or mixed

Interchangeable Fuel Beds

Log-effect
Crystal Ice Effect

Dimensions w x h x d (mm)

Midi: 416 x 639 x 348
Midi Midline: 416 x 791 x 348



Programmable
Thermostatic
Eco Remote
Control



Vogue Midi Electric with Log & Pebble Fuel effects and Amber flame setting



Vogue Midi T Highline Electric with Log & Pebble fuel effects and Amber flame setting.



vogue midi t



Vogue Midi T Electric with Log & Pebble fuel effects and Amber and Blue accent flame setting.



Vogue Midi T Midline Electric with Log & Pebble Fuel effects and Amber flame setting



Vogue Midi T Wall Hung Electric with Log & Pebble fuel effects and Amber and Blue accent flame setting.

The stylish Vogue Midi T range comprises a collection of tall contemporary stoves. All Vogue Midi T stoves feature windows on either side of the stove body to supplement the large front window, ensuring the display is visible from almost any angle in the room.

The Vogue Midi T can be selected as a plinth-mounted stove or in Midline and Highline log store versions. Alternatively, a statement wall-hung model creates a floating installation for a strikingly modern look. The Vogue Midi T can be enhanced with our range of stove benches, for more information see page 44.

Finish
Matt Black

Heat Output
0.75 - 1.50kW
(or flame effect only)

Flame Visual Settings
Amber, Blue or mixed

Interchangeable Fuel Beds
Log-effect
Crystal Ice Effect

Dimensions w x h x d (mm)
Midi T: 418 x 776 x 349
Midi T Midline: 418 x 928 x 349
Midi T Highline: 418 x 1260 x 349
Midi T Wall Mounted : 416 x 776 x 348 (360*)

*360mm is depth with wall mounted bracket.



Programmable
Thermostatic
Eco Remote
Control

vision electric



Vision Small Electric with Crystal-Ice fuel effect and Blue flame setting on 100 High Bench



Vision Medium Electric with Log & Pebble fuel effects and Amber flame setting

The Vision is a contemporary, electric stove that comes in three sizes: Small, Midi and Medium; each sporting a highly reflective black glass door, integral glass plinth, black glass top plate and contrasting stainless steel detailing for a clean stylish look.

To increase your interior design possibilities, you can enhance your Vision by choosing from one of ten stylish Stove Benches as shown on page 44.

Finish

Black Glass

Heat Output

1.00 - 2.00kW
(or flame effect only)

Flame Visual Settings

Amber, Blue or mixed

Interchangeable Fuel Beds

Log-effect
Crystal Ice Effect

Dimensions w x h x d (mm)

Small: 370 x 555 x 299

Midi: 415 x 604 x 320

Medium: 535 x 676 x 363



Programmable
Thermostatic
Eco Remote
Control



Vision Midi Electric with Log & Pebble fuel effects and Amber flame setting



Sheraton 5 Electric with Log & Pebble fuel effect and Amber flame setting

sheraton 5 electric



Sheraton 5 Electric with Log & Pebble fuel effect and Amber and Blue flame setting



Sheraton 5 Electric with Log & Pebble fuel effect and Amber flame setting with Grafton Limestone mantel

The Sheraton 5 Electric stove brings style, elegance, and remarkably realistic flame visuals to any interior. Cast iron bevelling and corning to the door, top plate and base give this stove a classic but timeless appearance that will suit modern and traditional settings alike.

Featuring a choice of fuel effects alongside our Chromalight® Immersive LED systems, the Sheraton 5 Electric gives you a variety of display options that can be mixed and matched to create a bespoke focal point.

Finish

Matt Black

Heat Output

0.75 - 1.50kW
(or flame effect only)

Flame Visual Settings

Amber, Blue or mixed

Interchangeable Fuel Beds

Log-effect
Crystal Ice Effect

Dimensions w x h x d (mm)

458 x 614 x 371



Programmable
Thermostatic
Eco Remote
Control

stockton electric



Stockton2 Medium Electric with Log & Pebble fuel effect and Amber flame setting



Stockton2 Small Electric with Log & Pebble fuel effect and Amber flame setting

With their cast iron doors and heavy gauge steel bodies, Stockton stoves combine the classic looks of a woodburning stove with the ease and convenience of electric.

Featuring our advanced Chromalight® technology, the Stockton's flame effects are projected among the fuel bed for a three-dimensional visual, whilst the various fuel effect options are lit from above and below for increased realism. The range of LED colour settings and interchangeable fuel bed options gives you the freedom to tailor your stove's visuals to suit your mood.

Finish
Matt Black

Heat Output
0.75 - 1.50kW
(or flame effect only)

Flame Visual Settings
Amber, Blue or mixed

Interchangeable Fuel Beds
Log-effect
Crystal Ice Effect

Dimensions w x h x d (mm)
Stockton2 Small: 438 x 525 x 338
Stockton 5: 481 x 544 x 337
Stockton2 Medium: 601 x 616 x 412



Programmable
Thermostatic
Eco Remote
Control



Stockton 5 Electric with Log & Pebble fuel effects and amber flame setting

marlborough2 electric



Marlborough2 Small Electric with Log & Pebble fuel effect and Amber flame setting



Marlborough2 Medium Electric with Log & Pebble fuel effect and Amber flame setting

Country or city, traditional or contemporary, the innovative Marlborough2 Electric has the flexibility to suit your lifestyle and your décor. With their expansive viewing windows, enjoy the warming flame visuals with or without the heat from the comfort of your sofa.

Finish

Matt Black

Heat Output

1.00 - 2.00kW
(or flame effect only)

Flame Visual Settings

Amber, Blue or mixed

Interchangeable Fuel Beds

Log-effect
Crystal Ice Effect

Dimensions w x h x d (mm)

Small: 429 x 533 x 280

Medium: 600 x 583 x 380



Programmable
Thermostatic
Eco Remote
Control



huntingdon electric



Huntingdon 30 Electric with Tracery Door in Matt Ivory with Log & Pebble fuel effect and Amber flame setting



Huntingdon 20 Electric with Tracery Door in Matt Black with Log & Pebble fuel effect and Amber flame setting

The fine castings of the Huntingdon Electric range are brought alive with Gazco's Chromalight® technology, The Huntingdon Electric range is available in a number of finishes to complement your home. For even more styling options, each size is also offered in either clear door or tracery door versions.

Finish

Matt Black
Matt Ivory
Ivory Enamel

Door Choice

Tracery Door
Clear Door

Heat Output

1.00 - 2.00kW
(or flame effect only)

Flame Visual Settings

Amber, Blue or mixed

Interchangeable Fuel Beds

Log-effect
Crystal Ice Effect

Dimensions w x h x d (mm)

20: 413 x 536 x 324
30: 560 x 592 x 351
40: 641 x 653 x 397

Programmable Thermostatic
Eco Remote Control





Huntingdon 40 Electric with Clear Door in Matt Black with Log & Pebble fuel effect and Amber flame setting. Shown with Claremont Limestone Mantel.

technical information - electric fires

radiance inset edge

Product Code	Description	Flame Viewing Area (mm) w x h	Heat Output
219-148	Radiance Inset 85R Edge	855 x 291	1.00 - 2.00kW
219-164	Radiance Inset 105R Edge	1055 x 291	1.00 - 2.00kW
219-170	Radiance Inset 135R Edge	1355 x 291	1.00 - 2.00kW

fire dimensions - radiance inset

All dimensions in mm

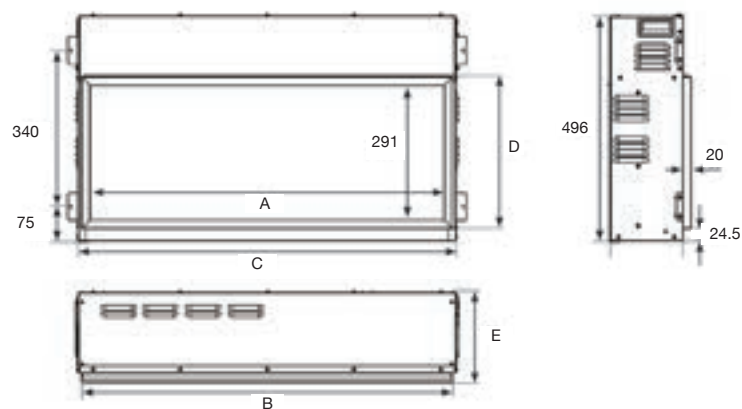

	A	B	C	D	E
Radiance 85R Inset	855	901	912	336	196
Radiance 105R Inset	1055	1101	1112	336	196
Radiance 135R Inset	1355	1401	1412	336	196

optional fuel effects

Fuel Effect	Product codes		
	85R	105R	135R
Clear Crushed Glass	919-021	919-021	919-034
Black Glass Beads	923-788	923-788	923-735
Clear Glass Beads	923-774	923-774	923-797

riva2 670 electric

Product Code	Fuel Effect	Heat Output	Opening Size (mm)		
			w	h	d
234-872	Logs	1.00 - 2.00kW	665	535	105

Riva2 670 Electric Wall Mounting Box

8688SL Wall mounting box for Riva2 670 Electric Cassette (234-872)

The wall mounting box allows you to hang your Riva2 670 directly onto the wall, without the need for an opening or recess.

fire dimensions

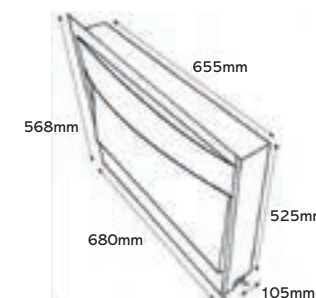

frame information

Product Code	Description	Frame Finish	Frame Size (mm)		
			w	h	d
934-339	Designio2 frame	Black Glass	735	569	40
934-238	Designio2 frame	Graphite	735	569	40
934-238IR	Designio2 frame	Iridium	735	569	40
934-529	Evoke frame	Black Glass front with Graphite rear	920	622	41
934-558	Evoke frame	White Glass front with Graphite rear	920	622	41
934-601	Evoke frame	Graphite front with Graphite rear	920	622	41
934-143	Verve XS frame	Graphite	1000	621	56



Radiance Inset 135R Edge

logic2 electric

progress frame dimensions

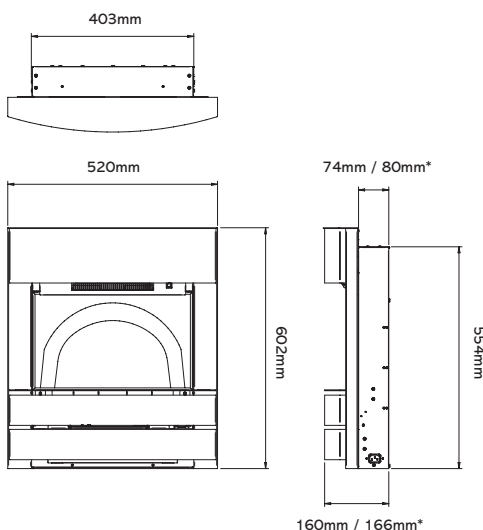

* The depth of the Logic2 Electric fires are increased by 6mm when using an optional spacer frame.

arts, wave & chartwell frame dimensions

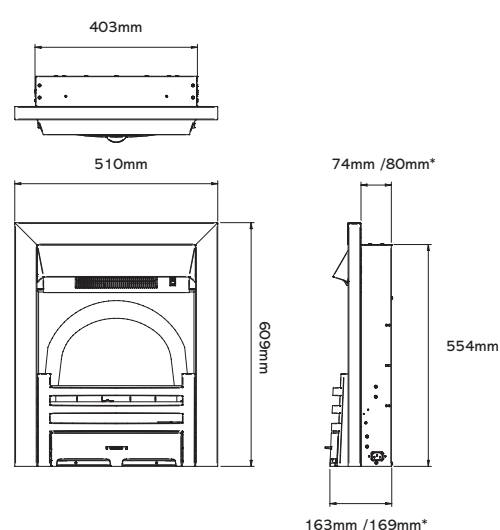

Product Code	Front	Frame Finish	Front Finish	Heat Output
--------------	-------	--------------	--------------	-------------

arts fire information

201-005	Arts	Matt Black	Matt Black	1.00 - 2.00kW
201-038	Arts	Matt Black	Brass Effect	1.00 - 2.00kW
201-081	Arts	Matt Black	Polished Effect	1.00 - 2.00kW
201-099	Arts	Matt Black	Highlight Polished	1.00 - 2.00kW
201-132	Arts	Brass Effect	Brass Effect	1.00 - 2.00kW
201-148	Arts	Polished Steel Effect	Matt Black	1.00 - 2.00kW
201-173	Arts	Polished Steel Effect	Polished Effect	1.00 - 2.00kW
201-197	Arts	Polished Steel Effect	Highlight Polished	1.00 - 2.00kW
201-222	Arts	Brushed Steel Effect	Matt Black	1.00 - 2.00kW
201-236	Arts	Brushed Steel Effect	Polished Effect	1.00 - 2.00kW
201-401	Arts	Brushed Steel Effect	Highlight Polished	1.00 - 2.00kW

Product Code	Front	Frame Finish	Front Finish	Heat Output
--------------	-------	--------------	--------------	-------------

wave fire information

201-416	Wave	Matt Black	Matt Black	1.00 - 2.00kW
201-504	Wave	Matt Black	Brass Effect	1.00 - 2.00kW
201-360	Wave	Matt Black	Polished Effect	1.00 - 2.00kW
201-384	Wave	Matt Black	Highlight Polished	1.00 - 2.00kW
201-688	Wave	Brass Effect	Brass Effect	1.00 - 2.00kW
201-717	Wave	Polished Steel Effect	Matt Black	1.00 - 2.00kW
201-591	Wave	Polished Steel Effect	Polished Effect	1.00 - 2.00kW
201-828	Wave	Polished Steel Effect	Highlight Polished	1.00 - 2.00kW
201-757	Wave	Brushed Steel Effect	Matt Black	1.00 - 2.00kW
201-269	Wave	Brushed Steel Effect	Polished Effect	1.00 - 2.00kW
201-323	Wave	Brushed Steel Effect	Highlight Polished	1.00 - 2.00kW

chartwell fire information

201-742	Chartwell	Matt Black	Matt Black	1.00 - 2.00kW
201-708	Chartwell	Matt Black	Brass Effect	1.00 - 2.00kW
201-655	Chartwell	Matt Black	Polished Effect	1.00 - 2.00kW
201-626	Chartwell	Matt Black	Highlight Polished	1.00 - 2.00kW
201-554	Chartwell	Brass Effect	Brass Effect	1.00 - 2.00kW
201-511	Chartwell	Polished Steel Effect	Matt Black	1.00 - 2.00kW
201-392	Chartwell	Polished Steel Effect	Polished Effect	1.00 - 2.00kW
201-314	Chartwell	Polished Steel Effect	Highlight Polished	1.00 - 2.00kW
201-293	Chartwell	Brushed Steel Effect	Matt Black	1.00 - 2.00kW
201-024	Chartwell	Brushed Steel Effect	Polished Effect	1.00 - 2.00kW
201-070	Chartwell	Brushed Steel Effect	Highlight Polished	1.00 - 2.00kW

progress fire information

201-103	Progress	Iridium		1.00 - 2.00kW
---------	----------	---------	--	---------------

optional spacer frames†

901-815	Logic2 Electric Arts, Chartwell & Wave Spacer Frame - Black
901-860	Logic2 Electric Progress Spacer Frame - Graphite

† Logic2 Electric Spacer Frames are for use when installing onto a flat wall.

technical information - electric stoves

vogue midi

Code	Model	Fuel Effect	Heat Output
663-806	Midi	Various	0.75 - 1.50kW
663-834	Midi Midline	Various	0.75 - 1.50kW

Dimensions (mm)	A	B	C	D	E	Weight
Midi	416	639	348	306	337	42kg
Midi Midline	416	791	348	306	337	48kg

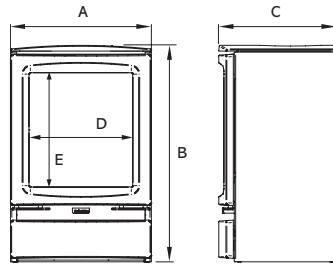

sheraton 5

Code	Model	Fuel Effect	Heat Output
605-832	Sheraton 5	Various	0.75 - 1.50kW

Weight: 43kg

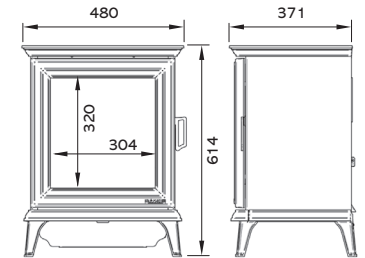

vogue midi t

Code	Model	Fuel Effect	Heat Output
663-819	Midi T	Various	0.75 - 1.50kW
663-851	Midi T Midline	Various	0.75 - 1.50kW
663-896	Midi T Highline	Various	0.75 - 1.50kW
663-860	Midi T Wall Mounted	Various	0.75 - 1.50kW

Dimensions (mm)	A	B	C	D	E	F	G	Weight
Midi T	417	776	348	306	475	115	434	38kg
Midi T Midline	417	927	348	306	475	115	434	44kg
Midi T Highline	417	1260	348	306	475	115	434	65kg
Midi T Wall Mounted	417	776	348*	306	475	115	434	44kg

*360mm is depth with wall mounting bracket.

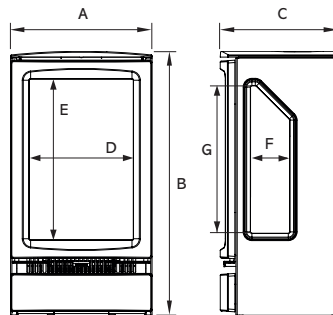

stockton2 and stockton 5

Code	Model	Fuel Effect	Heat Output
604-144	Small	Various	0.75 - 1.50kW
604-172	5	Various	0.75 - 1.50kW
604-203	Medium	Various	0.75 - 1.50kW

Dimensions (mm)	A	B	C	D	E	F	Weight
Small	438	525	289	49	232	220	50kg
5	481	544	273	64	267	212	55kg
Medium	601	617	347	65	398	258	72kg

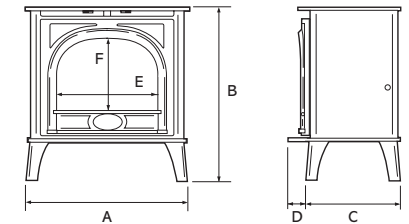

vision

Code	Model	Fuel Effect	Heat Output
634-808	Small	Various	1.00 - 2.00kW
634-846	Midi	Various	1.00 - 2.00kW
634-889	Medium	Various	1.00 - 2.00kW

Dimensions (mm)	A	B	C	D	E	Weight
Small	370	555	299	254	240	24kg
Midi	415	604	320	316	214	28kg
Medium	535	676	363	408	274	38kg

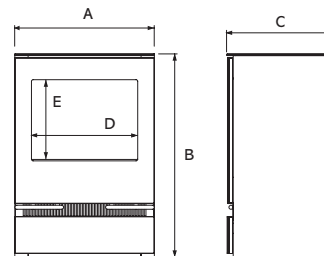

marlborough2

Code	Model	Fuel Effect	Heat Output
659-085	Small	Various	1.00 - 2.00kW
659-112	Medium	Various	1.00 - 2.00kW

Dimensions (mm)	A	B	C	D	E	F	Weight
Small	429	558	355	280	232	211	33kg
Medium	600	583	406	330	398	241	50kg

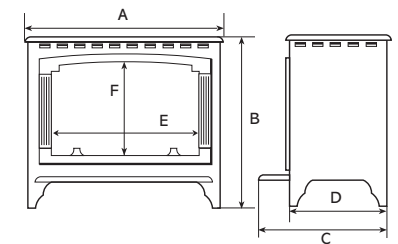

huntingdon

Dimensions (mm)

	A	B	C	D	E	F	Weight
20	413	536	324	62	234	223	35kg
30	560	592	351	96	323	230	52kg
40	641	653	397	99	402	265	59.5kg

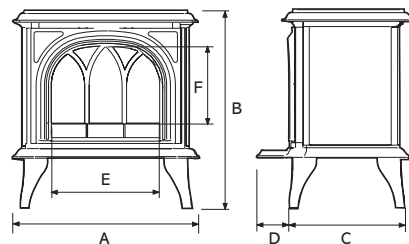

Code	Model	Colour	Fuel Effect	Door Type	Heat Output
615-258	20	Matt Black	Various	Tracery	1.00 - 2.00kW
615-624	20	Matt Ivory	Various	Tracery	1.00 - 2.00kW
614-371	20	Ivory Enamel	Various	Tracery	1.00 - 2.00kW
615-011	20	Matt Black	Various	Clear	1.00 - 2.00kW
615-050	20	Matt Ivory	Various	Clear	1.00 - 2.00kW
615-037	20	Ivory Enamel	Various	Clear	1.00 - 2.00kW
615-285	30	Matt Black	Various	Tracery	1.00 - 2.00kW
615-643	30	Matt Ivory	Various	Tracery	1.00 - 2.00kW
615-427	30	Ivory Enamel	Various	Tracery	1.00 - 2.00kW
615-094	30	Matt Black	Various	Clear	1.00 - 2.00kW
615-183	30	Matt Ivory	Various	Clear	1.00 - 2.00kW
615-142	30	Ivory Enamel	Various	Clear	1.00 - 2.00kW
615-302	40	Matt Black	Various	Tracery	1.00 - 2.00kW
615-662	40	Matt Ivory	Various	Tracery	1.00 - 2.00kW
615-613	40	Ivory Enamel	Various	Tracery	1.00 - 2.00kW
615-123	40	Matt Black	Various	Clear	1.00 - 2.00kW
615-222	40	Matt Ivory	Various	Clear	1.00 - 2.00kW
615-157	40	Ivory Enamel	Various	Clear	1.00 - 2.00kW

The above information is to assist in your choice of a suitable Gazco stove. It is not intended to be all information required to install your fire. This can be obtained from your local Gazco retailer or you can download the full installation instructions from the Gazco website at www.gazco.com

product improvement & photography

Gazco pursue a policy of continuous product improvement, therefore, whilst our products are correct at the time of the photography, we reserve the right to make alterations and amendments. Exact product details should be discussed with your retailer at the time of purchase.

Owing to variations in studio lighting and printing inks, the colours of stoves illustrated in this brochure may differ slightly from actual models.



further information

stove benches

These versatile steel benches are compatible with the Vision and Vogue Stoves. With a variety of sizes they offer greater design possibilities such as central or offset stove positioning, expanding your styling options.



Electric Vision Midi with Log and Pebble Fuel effects and Amber flame setting on 100 High Bench



Product Code	Bench	W (mm)	H (mm)	D (mm)
RVACLB45BHT	45 Low bench	450	250	420
RVACB45BHT	45 High bench	450	350	420
RVACLB100BHT	100 Low bench	1000	250	420
RVACB100BHT	100 High bench	1000	350	420
RVACLB120BHT	120 Low bench	1200	250	420
RVACB120BHT	120 High bench	1200	350	420
RVACLB140BHT	140 Low bench	1400	250	420
RVACB140BHT	140 High bench	1400	350	420
RVACLB180BHT	180 Low bench	1800	250	465
RVACB180BHT	180 High bench	1800	350	465

Deeper Bench Options (500mm Deep)

RVACLB120BHT	120 Low bench	1200	250	500
RVACB120BHT	120 High bench	1200	350	500
RVACLB140BHT	140 Low bench	1400	250	500
RVACB140BHT	140 High bench	1400	350	500
RVACLB180BHT	180 Low bench	1800	250	500
RVACB180BHT	180 High bench	1800	350	500

WIN

the cost of your product back!*

For further home inspiration you can **view real life installations** at our Customer Showcase page and share your thoughts and photos of your new stove or fire installation to enter our draw!

- We will publish your entry on our Customer Showcase
- You will be entered into a draw for the chance to win the cost of your product back
- **Gain a second entry** by registering your product online for your free extended warranty at gazco.com/registration



"I knew as soon as I saw it that was the one for our living room"

"We absolutely love our fire"

View real life installations and submit your review at

gazco.com/customershowcase

* Terms and conditions apply. See online for details



Vogue Midi T Highline Electric with Log & Pebble fuel effects and Amber flame setting.



eReflex 110W Outset with Log & Pebble fuel effects



eReflex 75R Inset with Log & Pebble fuel effects and Claremont Mantel in Limestone with matching slip set

The Gazco Electric fire collection also features the eReflex range, which feature advanced LED flame and lighting technology for stunning, atmospheric visuals.

Offering captivating, realistic flame pictures in a choice of effects and colours, these designer fires are available in either wall mounted or inset versions, as well as a variety of sizes. eReflex fires can even be selected in multi-sided models for a superb bespoke installation. A choice of elegant styling options and fuel effects allow the eReflex to be tailored to your décor – offering the utmost sophistication and style.

For more information on the full range or other Gazco products, please contact your local retailer or visit www.gazco.com

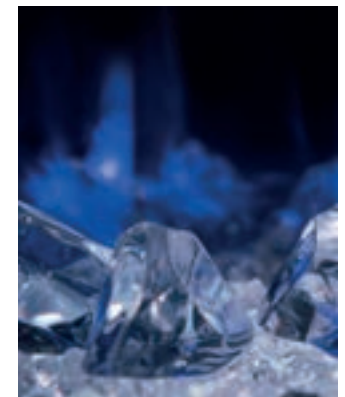



eReflex 110W Trento Left Offset with Log & Pebble fuel effect



Riva2 670 Electric Evoke Glass with Black Glass front & Graphite rear



Logic2 Electric Wave with Polished Steel Effect Frame, Polished Front and Log-effect fuel bed on Amber flame setting.



Gazco Limited, Osprey Road, Sowton Industrial Estate, Exeter, Devon, England EX2 7JG • **Tel:** 01392 261900
Export Sales: 00 44 1392 261990 • **Email:** info@gazco.com

gazco.com   

Gazco gratefully acknowledges the assistance of the following companies with photographic settings:

www.amara.com; www.furniturevillage.co.uk; www.theorangerie.co.uk; www.habitat.co.uk; www.houseoffraser.co.uk; www.electique.co.uk; www.debenhams.com;
 www.next.co.uk; www.mokodirect.co.uk; www.marksandspencer.com; www.frenchconnection.com; www.urbanoutfitters.com/uk; www.tkmaxx.com; www.homesense.com;
 www.johnlewis.com; www.coxandcox.co.uk; www.urbanara.co.uk; www.amoslighting.co.uk; www.farmington.co.uk; www.bnsp.co.uk; www.grandisson.com;
 www.rudloe-stone.com; www.beechbros.co.uk; www.originalstyle.com; www.stbridgetnurseseries.co.uk; www.amtico.com; www.opiesuk.co.uk; www.graceandgloryhome.co.uk;
 www.sofarooms.co.uk; www.chunkymonkeyfurniture.co.uk; www.wallsandfloors.co.uk; www.desenio.co.uk; www.birlea.com; www.ikea.com.

Paper sourced from sustainable forests and printed using vegetable based inks. © Copyright Gazco Ltd 2020 E & O E

find your retailer

You can find your nearest retailer by visiting:
www.gazco.com/retailers



Your Gazco stockist:	£3.00
Brochure ref: GZELECTRIC0720	
	