

# AGF Professional 1500

## INSTALLATION INSTRUCTIONS



**A GRADE FINISH  
CANOPIES**

*BBK Rangehood and Commercial Canopy Specialists*

9 Norfolk Court, Coburg North Victoria 3058

Tel: (03) 9355 7100

Fax: (03) 9355 7166

Email: [sales@agradefinish.com.au](mailto:sales@agradefinish.com.au)

Web: [www.agradefinish.com.au](http://www.agradefinish.com.au)

# Index

1. Welcome .....	1
2. Safety .....	2
3. Item check list .....	2
4. Installation.....	3
5. Operation .....	7
6. Maintenance.....	8
7. Technical support .....	10
8. Warranty.....	10

## 1. Welcome

Congratulations on your purchase of AGF Professional 1500 Rangehood

Please make sure to read through the installation instructions prior to installing the unit as it contains important information.

Please make sure you follow these installation instruction as they contain vital safety information.

Be sure to keep your proof of purchase as this will be needed for warranty.

This canopy rangehood is an indoor appliance and has been manufactured and tested to comply with Australian Standard/New Zealand AS/NZS60335.2.31:2004 inc amendment 1 & 2

The Rangehood is marked with the Regulatory Compliance Mark to show it has been approved



**CAUTION**

## 2. Safety

**Please read this section prior to operating this unit.**

If you find the rangehood is damaged in anyway please do not install and contact A Grade Finish Canopies ASAP on (03) 9355 7100.

This appliance is not intended for use by young children or infirm persons without adequate supervision.

There is a fire risk if cleaning is not carried out in accordance with the instructions.

Do Not Flambé under the rangehood

There should be adequate ventilation of the room when the rangehood is used at the same time with appliances burning gas or other fuels.

You must read the details concerning the method and frequency of cleaning.

The appliance is supplied with an approved power cable. If the supply cord of this equipment is damaged, it must only be replaced by the manufacturer, its service agent or similarly qualified person in order to avoid hazard.

Always switch power off prior to installing, servicing or cleaning the appliance.

## 3. Item Check list

1. AGF PROFESSIONAL 1500 RANGEHOOD BOX
2. 2 x AGF310 ROOF MOUNT FAN
3. 2 x 1000mm OF SOLID 305MM DUCTING

### **AGF PROFESSIONAL 1500 RANGEHOOD BOX CONTENTS**

- 1 x rangehood (including filters)
- 1 x 2 piece telescopic flu
- 1 x top flu mount bracket
- 2 x 5 meter flexible duct
- 2 x joiner
- 1 x 3 way junction
- 2 x flue support bracket

#### **Not included in box**

- All fixings
- Roof seal kit (Dektite)
- Silicone
- Double adapter

## 4. Installation

### Step 1:

Open box and check there is no damage to the rangehood (if there is any damage please contact a grade finish canopies on (03) 9355 7100). DO NOT INSTALL.

### Step 2:

Mark out the centre of where you wish to install the rangehood. (Refer figure 1)

### Step 3:

Mark out the height that you rangehood is to be installed at. (Refer figure 2)

### Step 4:

Hold rangehood up to the marks (step 2 and 3) and mark the mounting points. (Refer figure 3)

### Step 5:

Screw fixings into marks for mounting

### Step 6:

Hang the rangehood and tighten to fix to the wall. (Refer figure 4)

Figure 1

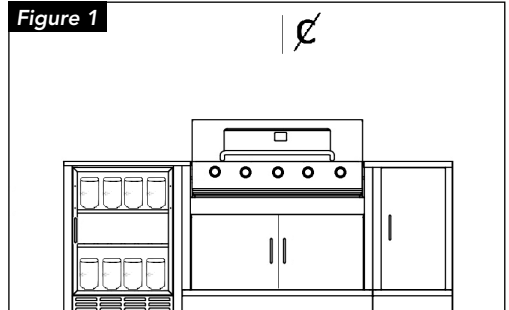

Figure 2

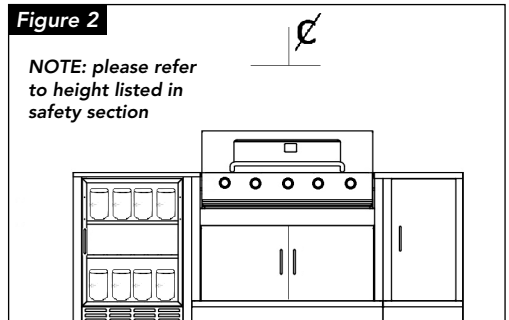

Figure 3

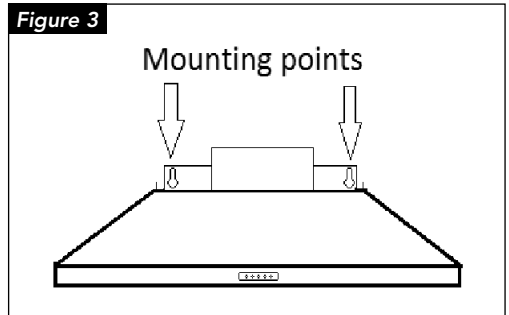
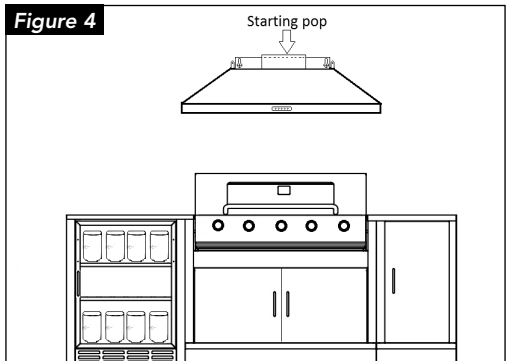

Figure 4



## 4. Installation *continued*

### Step 7:

Cut a hole in the ceiling above the rangehood to enable the flexible ducting and power cables to pass through easily.

Be sure not to make the hole bigger than the flue cover.

The hole will need to be big enough to be able to pass the power cables though to the ceiling.

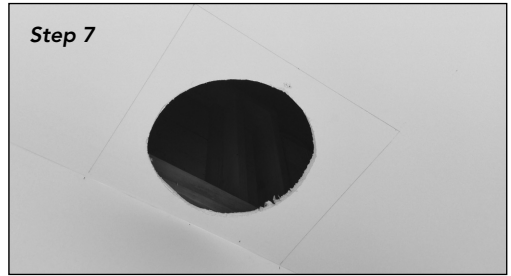

### Step 8:

Installing the solid ducts

For this step you will need to mark out where the ducting is to pass through the roof.

Make sure that when marking out the location of the ducting it is next to a beam (for support). With the location of the ducting confirmed cut the hole out in the roof leaving 250mm outside the roof.

Screw the ducting into a beam for support.

Install the flue support bracket to the beam and screw to the duct. (Refer figure 5 / 6)

Repeat for the second duct.

Please leave a minimum gap of 500mm between the solid ducts. (Refer figure 7)

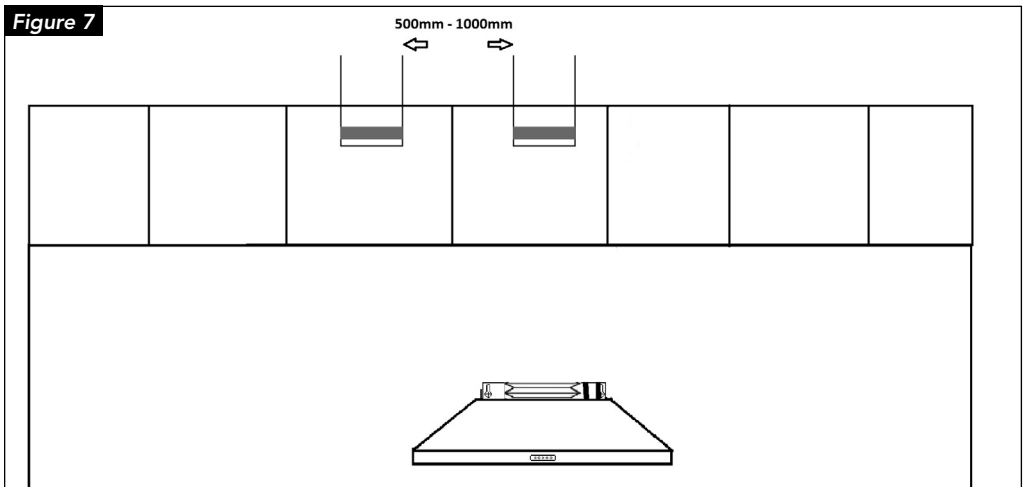
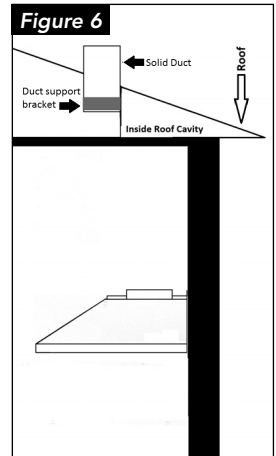
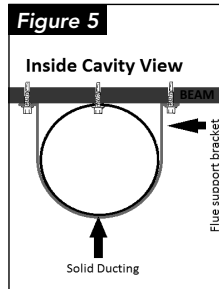

## 4. Installation *continued*

### Step 9:

install the flue cover bracket 150mm down from the ceiling. (Refer figure 8)

### Step 10:

Installing the flexible duct to the solid duct and connecting the 3 way junction.

Install the joiner to the bottom of the solid ducts and secure with screws leaving about half of the joiner out the bottom to allow for the flexible ducts to connect to. (Refer figure 9)

Connect one end of the flexible duct to the stating pop on the rangehood. Secure this with some PVC duct tape. (Refer figure 9)

Figure 8

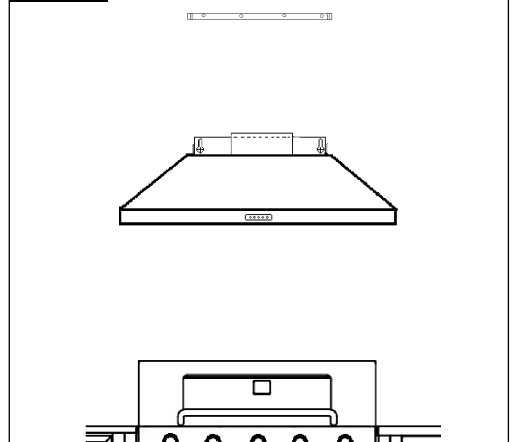
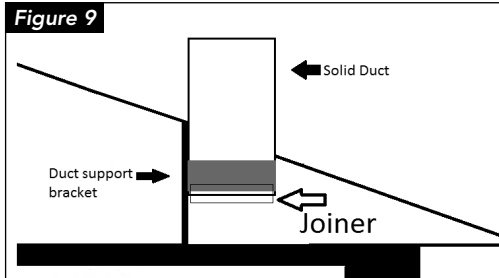

Figure 9



Pass the flexible duct through the hole in the ceiling and connect to the 3 way joiner. Secure with PVC duct tape.

Connect the flexible to the solid ducting and the 3 way joiner and secure with PVC duct tape.

If you need to install the flexible duct with a bend do not make the bend too sharp as this can restrict airflow. (Refer figure 11 as an example for correct instalment of bend)

### Step 11:

Install the rubber dektite over the solid duct. Do not fix down at this point refer step 13. (This can be purchased at additional cost via our online store: [www.agradefinish.com.au](http://www.agradefinish.com.au))

Figure 10

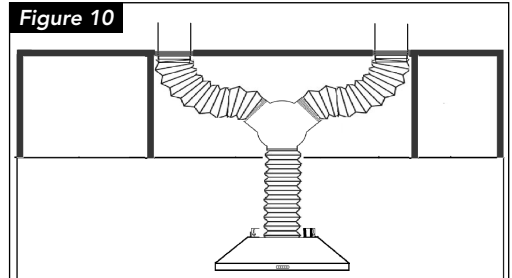
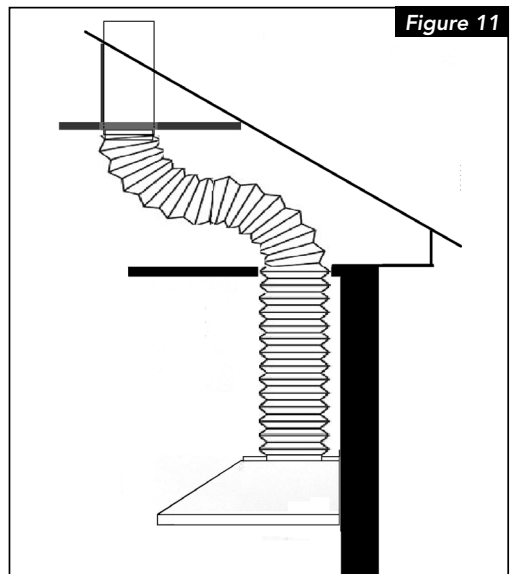

Figure 11



## 4. Installation continued

### Step 12:

Install the motor to the ducting. Slid the flange of the motor to the outside of the ducting and level the unit. Once level screw to the ducting. (Refer figure 12)

### Step 13:

With the motor now fixed pass the power lead from fan inside the dektite. (Refer figure 13)

### Step 14:

Once cable has been placed inside dektite finish screwing dektite down and silicon all edges.

### Step 15:

Connect male plug from rangehood to main power supply. (Refer figure 14)

### Step 16:

Connect female plug from rangehood to male plug of double adaptor. (Refer figure 14)

### Step 17:

Connect both of the fans to the double adaptor

### Step 18:

#### Installing the flue cover

With both flue pieces connected to each other (smaller piece to the outside) place on top of rangehood.

Slide the inner piece up to ceiling height and screw into the mounting bracket installed in step 9. (Refer Image 15/16)

With the top half of the flue now secure you will now need to secure the bottom piece

Screw the bottom piece to the rangehood and also screw to the top piece for extra support. (Refer figure 17)

### Step 19:

*Thank you for purchasing an A Grade rangehood.  
Enjoy!*

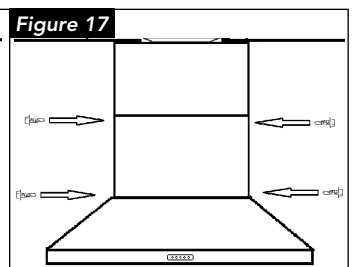
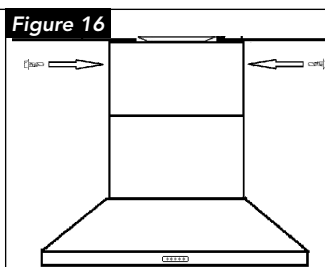
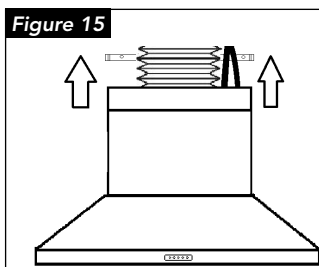
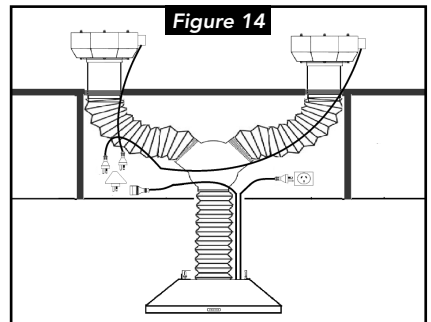
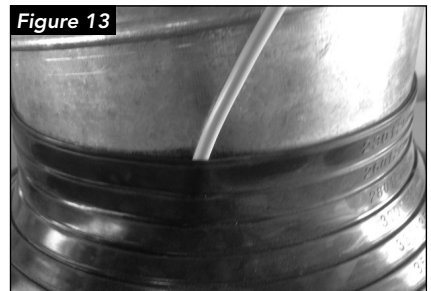
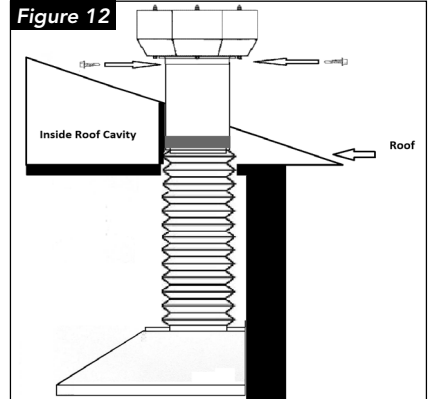

## 5. Operation

### Rangehood switch



#### Power on/off

(Fan will not operate without power being on)

While fan is running press power button once to engage the 3 minute timer. Once timer has completed unit will switch off (lights will still remain on after timer has completed). Press the power button second time to switch unit off and bypass the timer function.



#### Fan low speed



#### Fan medium speed



#### Fan high speed



#### Downlight operation

(power does not need to be on for downlights to operate)

### Filter Removal/Installation

When removing filters use both the handles and slide the filter to the back of the unit. Once you have the filter at the back of the unit this will enable the filter to release from the rangehood.

To Re-install the filters slide the filter to the back of the unit then slide to the front of the rangehood.

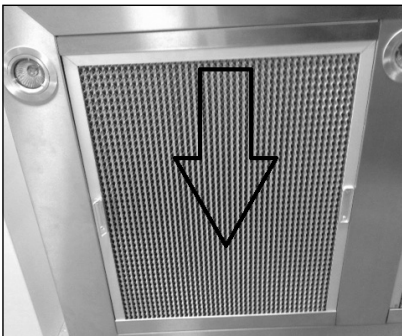

1. Slide filter to back of rangehood



2. Pull filter down and slide filter towards the front of the rangehood to release from body

3. To reinsert the filter do steps 1 and 2 in reverse



## 6. Maintenance

Please ensure that your unit is turned off prior to conducting any cleaning.  
Filters should be cleaned every 3 months or more frequently depending on the use.

**NEVER** turn the filters around. Handles are to be facing down at all times.

**NEVER USE CAUSTIC SODA AS THIS WILL DAMAGE FILTERS**

**Never** wipe unit with a wet cloth as water may affect the electrical switches.

We recommend the use of stainless steel cleaning wipes.

When cleaning your roof, cover roof mount fan with plastic if you are going to use chemicals.

### **Globe Removal**

**Ensure unit is turned off prior to replacing globes**

1. Rotate the inner globe holder in an anti-clockwise direction

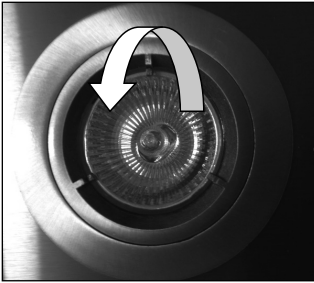

**Do not exceed 50 Watts**

2. Pull the globe holder and globe out and disconnect the globe from the lamp lead



**Do not exceed 50 Watts**

3. Once disconnected from the lamp lead, remove the halogen light from its housing



**Do not exceed 50 Watts**

## 6. Maintenance *continued*

4. Insert a new globe into the housing, making sure the globe fits nice and tight in the housing.

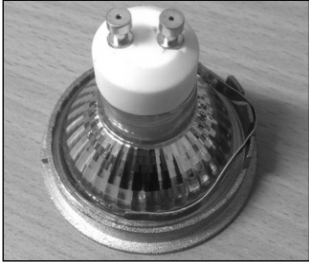

***Do not exceed 50 Watts***

5. Reconnect the globe and holder to lamp lead.



***Do not exceed 50 Watts***

6. Insert back into housing and turn in clockwise direction to lock into place.



***Do not exceed 50 Watts***

## 7. Technical Support

For all technical support please contact:

**A Grade Finish Canopies**

on **(03) 9355 7100**

or via email **[info@agraderfinish.com.au](mailto:info@agraderfinish.com.au)**

## 8. Warranty

AGF 1500 PRO-2 has a standard 24 months warranty from date of purchase.

An additional 12 months warranty can be purchased direct from A Grade Finish Canopies for \$250 Including GST.

This document sets out the terms and conditions of the product warranties for A Grade Finish Rangehoods. It is an important document. Please keep it with your proof of purchase documents in a safe place for future reference should there be a manufacturing defect in your Appliance. This warranty is in addition to other rights you may have under the Australian Consumer Law.

### 1. In this warranty:

- (a) 'ACL' or 'Australian Consumer Law' means Schedule 2 to the Competition and Consumer Act 2010;
- (b) 'Appliance' means any A Grade Finish product purchased by you and accompanied by this document;
- (c) 'Warranty Period' means the period specified in clause 3 of this warranty;
- (d) 'you' means the purchaser of the Appliance not having purchased the Appliance for re-sale, and 'your' has a corresponding meaning.

**2. Application:** This warranty only applies to new Appliances, purchased and used in Australia or New Zealand and is in addition to (and does not exclude, restrict, or modify in any way) other rights and remedies under a law to which the Appliances or services relate, including any nonexcludable statutory guarantees in Australia and New Zealand.

**3. Warranty Period:** Subject to these terms and conditions, this warranty continues for in Australia for a period of 24 months and in New Zealand for a period of 24 months, following the date of original purchase of the Appliance.

**4. Extended Warranty:** Available for additional 2 years. Refer A Grade Finish Canopies for price. Must be purchased within 30 days from date of purchase of product.

**5. Repair or replace warranty:** During the Warranty Period, A Grade Finish will repair or replace any parts which it considers to be defective. A Grade Finish may, in its absolute discretion, choose whether the remedy offered for a valid warranty claim is repair or replacement. A Grade Finish or its ASC may use refurbished parts to repair your Appliance. You agree that any replaced Appliances or parts become the property of A Grade Finish.

**6. Travel and transportation costs:** Subject to clause 7, A Grade Finish will bear the reasonable cost of transportation, travel and delivery of the Appliance to and from A Grade Finish or its ASC. Travel and transportation will be arranged by A Grade Finish as part of any valid warranty claim.

**7. Proof of purchase** is required before you can make a claim under this warranty.

**8. Exclusions:** You may not make a claim under this warranty unless the defect claimed is due to faulty or defective parts or workmanship. This warranty does not cover:

- (a) light globes, batteries, filters or similar perishable parts;
- (b) parts and Appliances not supplied by A Grade Finish;
- (c) cosmetic damage which does not affect the operation of the Appliance;

(d) damage to the Appliance caused by:

- (i) negligence or accident;
- (ii) misuse or abuse, including failure to properly maintain or service;
- (iii) improper, negligent or faulty servicing or repair works done by anyone other than an A Grade Finish authorised repairer or ASC;
- (iv) normal wear and tear;
- (v) power surges, electrical storm damage or incorrect power supply;
- (vi) incomplete or improper installation;
- (vii) incorrect, improper or inappropriate operation;
- (viii) insect or vermin infestation;
- (ix) failure to comply with any additional instructions supplied with the Appliance;

In addition, A Grade Finish is not liable under this warranty if:

- (a) the Appliance has been, or A Grade Finish reasonably believes that the Appliance has been, used for purposes other than those for which the Appliance was intended, including where the Appliance has been used for any non-domestic purpose;
- (b) the Appliance is modified without authority from A Grade Finish in writing;
- (c) the Appliance's serial number or warranty seal has been removed or defaced

**9. How to claim under this warranty:** To enquire about claiming under this warranty, please follow these steps:

- (a) carefully check the operating instructions, user manual and the terms of this warranty;
- (b) have the model and serial number of the Appliance available;
- (c) have the proof of purchase (e.g. an invoice) available;
- (d) telephone the numbers shown below.

**10. Australia:** For Appliances and services provided by A Grade Finish in Australia: A Grade Finish goods come with guarantees that cannot be excluded under the Australian Consumer Law. You are entitled to a replacement or refund for a major failure and for compensation for any other reasonably foreseeable loss or damage. You are also entitled to have the Appliance repaired or replaced if the Appliance fails to be of acceptable quality and the failure does not amount to a major failure. 'Acceptable quality' and 'major failure' have the same meaning as referred to in the ACL.

**11. New Zealand:** For Appliances and services provided by A Grade Finish in New Zealand, the Appliances come with a guarantee by A Grade Finish pursuant to the provisions of the Consumer Guarantees Act, the Sale of Goods Act and the Fair Trading Act. Where the Appliance was purchased in New Zealand for commercial purposes the Consumer Guarantee Act does not apply.

**12. Confidentiality:** You accept that if you make a warranty claim, A Grade Finish and its agents including ASC may exchange information in relation to you to enable A Grade Finish to meet its obligations under this warranty.

