

everdure
by heston blumenthal



CUBE™ 360

Assembly, operation &
maintenance instructions

for Everdure by Heston
Blumenthal CUBE™360
portable charcoal barbeque
with roasting hood

everdurebyheston.com



Inspired by the past.
Innovated for the future.

THE OUTDOOR
PERFORMANCE

CONTENTS

Important Safety Instructions	4-5
Appliance Details	6
Operating Instructions	6-7
Ignition Procedure	8
Cleaning & Storage	8
Maintenance	8
Troubleshooting	9
Barbeque Assembly	10-11

OPERATION AND MAINTENANCE INSTRUCTIONS FOR HBCUBE360B PORTABLE CHARCOAL BARBEQUE RANGE Everdure by Heston Blumenthal outdoor charcoal barbeques. It is important that you retain these instructions, proof of purchase as well as other important documents about this product for future reference. Due to continual product development, Everdure by Heston Blumenthal reserves the right to alter specifications or appearances without notice. Dispose of packaging responsibly – recycle where facilities are available.

IMPORTANT SAFETY INSTRUCTIONS

IMPORTANT:

Read the safety precautions of this booklet carefully before removing the barbeque from its carton.

1. This charcoal barbeque is intended for **OUTDOOR USE ONLY**. Do not use indoors!
2. For your safety and enjoyment, read all operating instructions before using this appliance.
3. This appliance can be used by children aged from 8 years and above and persons with reduced physical, sensory or mental capabilities or lack of experience and knowledge if they have been given supervision or instruction concerning use of the appliance in a safe way and understand the hazards involved. Children shall not play with the appliance. Cleaning and user maintenance shall not be made by children without supervision. Unsupervised children or pets should not be near a barbeque while cooking or during warm up or cool down. Ensure children or pets are kept a distance well away from the barbeque whilst it is in use. **WARNING!** Keep children and pets away.
4. Do not immerse the barbeque in water (only removable grills, charcoal chamber & grid).
5. As charcoal can smoulder for an extended period of time, take care when removing ash after cooking. It is recommended that a non-combustible container (metal or ceramic) be used to contain any ash before being doused in water and disposed of correctly.
6. This barbeque has been designed to be used either on a raised bench or the ground. Ensure the surface is level, large enough and strong enough to support the barbeque and will withstand temperatures of 80°C above ambient temperature. It's highly recommended to use a heat resistant barrier such as a ceramic tile, in order to avoid surface damage.
7. People with flammable clothing such as nylon etc. should keep well away from the barbeque when it is operating.
8. Do not use this appliance for any purpose other than what it is intended for.
9. In case of fat fire, remove food (if possible) and allow the fire to burn out naturally. Most fat will burn off quickly when it contacts the charcoal, but regular cleaning after use should reduce the build-up of fat and food residues which are combustible and can result in a fat fire. **Fat fires can be prevented with diligence in cleaning fats and**

oil from the inner chassis and charcoal chamber. Do not allow ash to build up inside the chassis – clean up after every use. For more information on controlling fat fires see the Quick User Guide.

10. Ensure that the product has adequate clearance from combustible materials. All combustible materials must be kept more than 250mm from the sides and rear of the barbeque and more than 1500mm above the cooking surface of the barbeque. This appliance is not meant to be built-in.
11. As charcoal cooking can vary in time and intensity, it is recommended that the barbeque not be left for more than 5 minutes at a time while cooking.
12. We recommend that you regularly maintain your barbeque and keep it in good condition. This can be achieved by following the cleaning and maintenance suggestions in this booklet. Failure to follow these instructions will void your warranty.
13. This appliance is not suitable for mounting in a movable vehicle (boat, trailer etc).
14. Do not use or store this appliance in areas of high salt content (a marine environment) or an area with caustic fumes or liquids (such as a domestic pool), as these chemicals can cause the appliance materials to deteriorate (and void the warranty). Regular cleaning and covering when not in use can help can help to reduce this.
15. Caution: Accessible parts may become hot when used. Whilst the barbeque handles are cool to touch, please be aware that the sides of the barbeque may be hot - handle with care.
16. Charcoal and coal products produce carbon monoxide when burned. When the appliance is being used with solid fuels, always keep the appliance in a well ventilated area to prevent the gasses produced from building up.
17. Do not use solid fuels impregnated with fire accelerants or use any other type of accelerant on this appliance. Using any accelerant could cause serious property damage or personal injury. **WARNING!** Do not use spirit or petrol for lighting or re-lighting! Only use firefighters complying to EN 1860-3!
18. During ignition, follow the recommended charcoal area placement guide. Once the initial batch of charcoal has ignited, it can be mixed in with fresh charcoal and spread throughout the charcoal chamber. Overloading the charcoal chamber can result in damage to the appliance and food – it is recommended that the height of the charcoal never passes the top level of the charcoal chamber. For more information on charcoal placement, see further on in the instruction manual and the Quick User Guide.

19. **WARNING!** This barbeque will become very hot, do not move it during operation. Always allow the solid fuel to burn out naturally after cooking. Do not use any liquids to douse the charcoal inside the barbeque. Do not move the appliance while the coals are still burning as hot ash, coal particles, unburned fuel and hot cooking fats & oils could spill and accessible parts may be very hot. The barbeque should only be lifted by using the side handles.
20. Do not use volcanic rock or any type of non-combustible product in the charcoal chamber. If in doubt on what fuels can be used, check the Everdure by Heston Blumenthal website or contact the Service Department.
21. Solid fuels differ widely in burning time, heat, size and combustion. Always be aware of your surroundings and potential fire hazards caused by sparks or spitting fuels. Never dispose of solid fuels or hot ashes in areas where they can be trodden on or be a fire hazard. Never dispose of unburned solid fuels or ash until it has completely extinguished. The barbeque must be installed on a secure level base prior to use. We recommend using 100% natural lump charcoal in this appliance (see everdurebyheston.com).
22. Always check with your local/state authorities before using this appliance for any fire restrictions regarding the use of an outdoor barbeque (due to local weather conditions).
23. When using solid fuels, take care that the surrounding environment is clear of combustible materials. Do not cook under overhanging buildings or close branches of trees. Note that solid fuels will produce varying amounts of smoke – take this into consideration when setting up the barbeque.
24. The barbecue shall be heated up and the fuel kept red hot for at least 30 min prior to the first cooking.



DO NOT OPERATE THIS APPLIANCE BEFORE READING THE INSTRUCTION BOOKLET

DO NOT PLACE ARTICLES ON OR AGAINST THIS APPLIANCE

DO NOT STORE CHEMICALS OR FLAMMABLE MATERIALS OR SPRAY AEROSOLS NEAR THIS APPLIANCE

DO NOT OPERATE THIS APPLIANCE INDOORS

DO NOT ENCLOSE THIS APPLIANCE. THE MINIMUM CLEARANCE FOR THIS UNIT IS 1500mm ABOVE THE COOKING SURFACE AND 250mm FROM ANY SIDE

DO NOT OPERATE THIS APPLIANCE IN ENCLOSED AREAS

DO NOT USE ACCELERANTS OR FUEL IMPREGNATED WITH ACCELERANTS IN THIS APPLIANCE

DO NOT OVERFILL THE CHARCOAL CHAMBER AT IGNITION

DO NOT ALLOW FATS/OILS, ASH AND UNBURNED FUEL TO BUILD UP IN THE APPLIANCE BETWEEN COOKING SESSIONS

APPLIANCE DETAILS

CUBET TM 360			
Barbeque with hood	LENGTH (mm)	WIDTH (mm)	HEIGHT (mm)
		347	425

OPERATING INSTRUCTIONS

GENERAL INSTRUCTIONS

A fairly protected location is desirable for pleasant and efficient cooking. Try to keep the barbeque sheltered from strong winds as this will drastically alter cooking efficiency. Keep the barbeque level. Check frequently that the charcoal stays ignited (this does not necessarily mean a flame is visible), and that flare ups are not occurring. Make sure the minimum distances of the barbeque to any wall or combustible surface are met, and that the supporting surface can withstand the heat.

WARNING! This barbeque will become very hot during operation. If you need to move it during operation, we recommend taking extreme care and grab by the handles only. Never grab the barbeque by the body or sides when in use.

For more specific information (including set-up illustrations and diagrams) and up to date cooking instructions, please visit the Everdure by Heston Blumenthal website at www.everdurebyheston.com.

FUEL TYPE AND CONSUMPTION

This barbeque is designed to cook with lump charcoal or charcoal briquettes. The heat produced and consumption time may vary dramatically depending on the type of fuel used, and the prevailing weather conditions. Please see the Quick User Guide for more information on charcoal ignition and cooking. Do not use accelerants for fuel ignition as they may cause damage to the appliance or injury. We recommend using 100% natural lump charcoal in this appliance (see everdurebyheston.com).

When igniting the charcoal, pile the charcoal up over the charcoal grid (this is the square wire grid in the centre of the charcoal chamber) **so that when levelled out the volume does not exceed the charcoal chamber and should not exceed 0.5Kg at any time.**

After cooking, the remaining charcoal should be allowed to burn off naturally (this should be taken into account when planning the cooking times). Once finished, the ash and remaining fuel should be removed and placed into a non-flammable container (a metal bucket is ideal), a small amount of water added (just in case there is still any heat left in the waste) and disposed of safely as per local council rules. Note that protection from heat should always be used.

CHROME OPEN GRILL

The cooking surface for this barbeque is a chromed open grill, which can be fully removed to add additional charcoal. The grill should be positioned so that it sits on the four grill support pins. Take care that food cooked is wider than the gaps in the grill or positioned lengthways so it doesn't fall through. Over time, the surface of the grill will discolour with the heat of the fuel (this is a normal process and not a fault). It is recommended that the grill is placed on the barbeque after the charcoal has ignited and any adjustment on the fuel distribution has been done. After use, allow the grill to cool and then clean. After cleaning, coat with a little cooking oil to minimise any rusting. Note – When adjusting the open grill while cooking (or still hot), use metal tongs or similar tools to hold the grill.

AFTER COOKING

1. After cooking and whilst the barbeque is still warm, remove scraps from the grill with a scraper.
2. Excess fat and meat scraps can be scraped off the inside of the barbeque by removing the grill to gain access.
WARNING: Some surfaces may still be hot – please use protective gloves.
3. Remove wastes from inside charcoal chamber, and barbeque chassis

everdure

by heston blumenthal

WARNING

Overloading the charcoal tray may result in damage to the product paint and surface area. Do not fill charcoal past the top of this tray.

WARNING

Underside of the barbeque must be kept clear at all times!

If the underside of this barbeque is blocked (with grass, sand or similar) hot air cannot escape, resulting in heat damage to the product and/or surface area.

WARNING

It is recommended that, while in use, the appliance is positioned on top of a heat-resistant barrier, such as a ceramic tile, in order to avoid surface damage. Placing the appliance on top of a non-heat resistant surface may cause damage to both the surface and appliance and such resulting damage is not covered by warranty

IGNITION PROCEDURE



READ ALL OPERATING INSTRUCTIONS BEFORE IGNITING THE CHARCOAL

LIGHTING THE BARBEQUE USING FIRELIGHTERS

The CUBE™360 is designed to be used with charcoal and ignited with firelighters. First pile the charcoal over the charcoal grid around the firelighters (follow the manufacturer's recommended set-up and ignition). After 10-15 minutes (depending on the weather conditions and the fuel used), most of the charcoal should have partially or fully ignited. Using metal tools, spread the charcoal inside the charcoal chamber and add extra fuel if necessary (extra fuel can be added during the cooking period as well). We recommend the use of Eco firelighters where available. Do not cook before the fuel has a coating of ash. See the Quick User Guide for more information.

CLEANING & STORAGE

EXTERNAL CLEANING

Before cleaning the barbeque exterior ensure the appliance has cooled and is safe to touch. Painted and plastic surfaces can be cleaned using a mild household detergent or cleaner and a clean cloth (do not use scourers or harsh detergents). **It is advisable to test cleaners on a small section of the appliance first. NEVER** use paint thinners or similar solvents for cleaning and **NEVER** pour cold water over hot surfaces. Dry the surface afterwards.

INTERNAL CLEANING

Before cleaning the internal parts of your barbeque, ensure the appliance has cooled and is safe to touch. The inside of the charcoal chamber can be cleaned by using some water, mild detergent and a sponge or mild scouring pad. For hard to clean areas, use a little baking soda on a wet sponge. Do not use abrasive cleaners.

All ash and any leftover fuel should be removed after every cook (take care that it is fully extinguished and cold). After cleaning the charcoal chamber, remove and clean any ash or oil that may have dropped into the barbeque chassis.

WARNING! The surfaces of the open grills may be hot. Please ensure heat resistant gloves are worn.

STORAGE

When the appliance is not in use, store in a dry location. Do not store in an area exposed to the weather. If the barbeque is stored outdoors, it must be under cover and covered, out of the weather. Ensure the cooking surface is clean before storing away.

MAINTENANCE

It is recommended that, at the commencement of each barbeque season, the following maintenance be conducted:

BARBEQUE

1. Wipe over the outer areas of the barbeque with a clean cloth.
2. Check all oils and ash has been cleaned from the charcoal chamber.
3. Check all fasteners for tightness and re tighten where necessary to ensure rigidity of the structure.

Wear and tear to this barbeque can be reduced by covering and storing out of the weather when not in use.

TROUBLESHOOTING

Solid fuel is not igniting or taking longer than expected to ignite:

Firelighters are not working	Check firelighters light. Replace if not working. Check manufacturer's instructions. Adjust charcoal to allow more ventilation.
Poor type of solid fuel used	Fuel may be wrong size (parts too large). Break up larger parts so they can ignite easier. Purchase a different type of charcoal and try. We recommend using 100% natural lump charcoal in this appliance (see everdurebyheston.com).
Solid fuel is damp	Solid fuels can become damp over time, which retards ignition. Store in a dryer place & repurchase fresh solid fuel.
Solid fuel incorrectly distributed in charcoal chamber	Follow the instructions on placing the solid fuel in the charcoal chamber. If charcoal has compacted down tight, remove some solid fuel so air can flow freely through and assist in ignition. If too little fuel is used, the heat and ignition may not pass as fast between separate pieces.
Barbeque not cleaned	Check ash has not collected inside chassis, or blocked the charcoal grid or chamber.
Weather conditions and ambient temperature	Cold, windy and wet conditions will affect the ignition and combustion process. Move barbeque to a more suitable location.

CORRECT DISPOSAL OF THIS PRODUCT







This marking indicates that this product should not be disposed with other household wastes throughout the EU. To prevent possible harm to the environment or human health from uncontrolled waste disposal, recycle it responsibly to promote the sustainable reuse of material resources. To return your used device, please use the return and collection systems or contact the retailer where the product was purchased. They can take this product for environmental safe recycling.

CHARCOAL BARBEQUE ASSEMBLY

The barbeque must be assembled before use. No tools are needed for assembly.

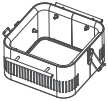
Open the carton from the top and remove the parts. Remove all packaging (especially check inside the barbeque and under the charcoal grid and charcoal chamber) and place parts on a clean surface. Check for any damage or missing parts (if found, contact your service department. For your local service department please go to everdurebyheston.com and select your country.).

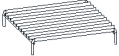
INCLUDED PARTS CUBE™360

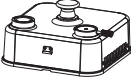
01 / Barbeque chassis assembly x 1Pc	02/ Charcoal Chamber x 1Pc	03 / Charcoal Grid x 1pc	04 / Open Grill x 1pc	05 / Roasting Hood x 1Pc
				

PACKAGING

Remove all internal cartons and packaging from within the barbeque assembly. Remove all external packaging and remove the appliance from the packaging base before operation. Recycle as per your local government laws.

STEP 01

/ Take the charcoal chamber (02) and place it in the barbeque chassis (01). Place the charcoal grid (03) legs down into the charcoal chamber.

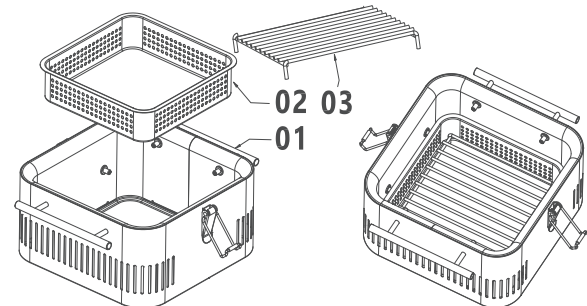

STEP 02

/Place the open grill (04) on the four support pins. The barbeque is now ready for cooking.

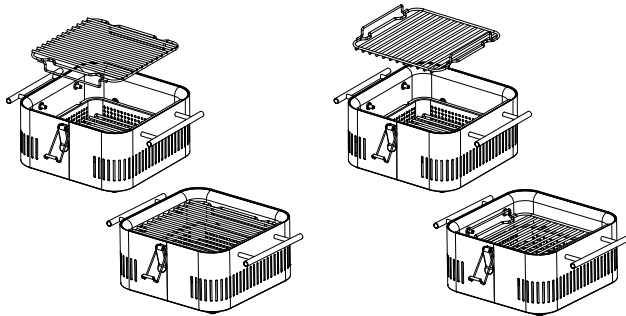

STEP 03

/Place the roasting hood onto the barbeque (barbeque must be clean and cool). Clamp the hood down with the side brackets.

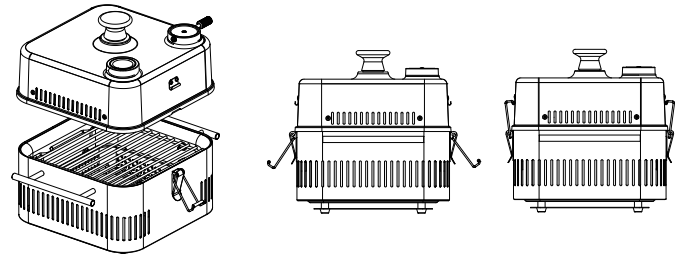

AIR VENTS ADJUSTMENT SETTING

/Side vents for extinguishing the charcoal.

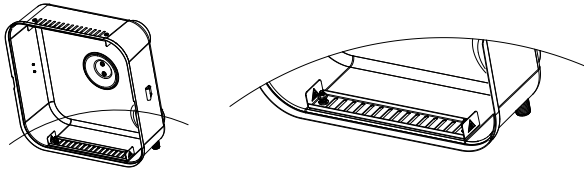

/Top vent controls air flow and heat.

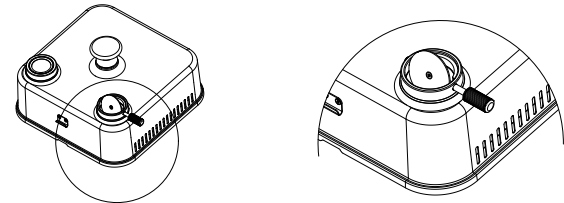

everdure
by heston blumenthal

IM Ref: CUBE360 11/2022/08

FOR OUTDOOR USE ONLY

everdurebyheston.com