

GIN 90 SERIES

FREESTANDING FIRE TABLES



Elegance, function and carefully conceived features combine to create a stunning focal point in the multi-functional Gin 90 Series of fire pit tables. Perfect for entertaining – whether in the home, hospitality or commercial setting – simply choose your preferred height (Low, Chat, Dining or Bar) and finish (Teak or Fluid Concrete) to complement your space and lifestyle and enjoy!

Finish

Available in a variety of Fluid concrete colours or Natural Teak finish.



Concrete Surround Options

Teak Surround Option

Relocate With Ease

Bioethanol fireplaces relocate with ease, and this portability is greatly enhanced by the self contained engineering of the EcoSmart system. There is no need for a utility connection, which means you can transform the look and feel of your indoor¹ or outdoor area when desired.

Global Compliance

This model complies with existing standards in the USA, Europe, UK and Australia. UL Listed, EN 16647 BSI Certified ACCC Safety Mandate compliant.

To comply with EN 16647 the Indoor Safety Tray must be installed before operating indoors.



Environmentally-Friendly

Bioethanol fireplaces use an environmentally-friendly, renewable energy source that burns clean and delivers warming heat. You and your guests will enjoy the ambiance and tranquility of a real fire, without the hassles of burning real wood - no more embers, ash, and soot to clean up.

Quick and Easy

With no installation or building works required, simply unpack, put into position, and off you go.

Versatile and Incredibly Durable

EcoSmart portable fireplaces are versatile, incredibly durable, and are constructed of weather resistant materials. These appliances are designed to look great for years, and will perform admirably through all four seasons.

Included Accessories









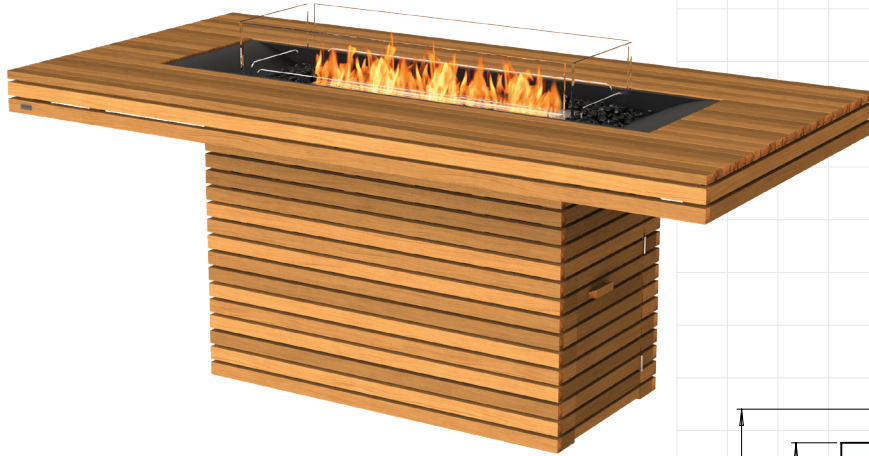

Optional Accessories



Disclaimer. All product specifications and data are subject to change without notice and believed to be correct at the time of publication. MAD Design Group (MDG), its affiliates, agents, and employees, and all persons acting on its or their behalf (collectively, "MAD Design Group"), disclaim any and all liability for any errors, inaccuracies or incompleteness contained herein or in any other disclosure relating to any product. MDG disclaims any and all liability arising out of the use or application of any product described herein or of any information provided herein to the maximum extent permitted by law. The product specifications do not expand or otherwise modify MDG's terms and conditions of purchase, including but not limited to the warranty expressed therein, which apply to these products. No license, express or implied, by estoppel or otherwise, to any intellectual property rights is granted by this document or by any conduct of MDG. Customers using or selling MDG products not expressly indicated for use in such applications do so entirely at their own risk and agree to fully indemnify MDG for any damages arising or resulting from such use or sale. Please contact authorised personnel from MDG to obtain written terms and conditions regarding products designed for such applications. Images are indicative only.

Gin 90 Bar



| | | | | | | | | | | | |
|---|---|---|---------|---------------------|---|------|---------------------|---|----------|---------------------|--|
| Application | Outdoor and Indoor ¹ | | | | | | | | | | |
| Materials | Fluid Concrete or Teak, Grade 304 Stainless Steel Burner, Toughened Glass Fire Screen | | | | | | | | | | |
| Weight (approx) | Concrete 180.5kg [397.1lbs] Teak 133kg [292.6lbs] Weight includes burner and accessories. | | | | | | | | | | |
| Concrete SKU's | <table border="0"> <tr> <td></td> <td>Natural</td> <td>ESF.5.O.GIN.90.B.NA</td> </tr> <tr> <td></td> <td>Bone</td> <td>ESF.5.O.GIN.90.B.BO</td> </tr> <tr> <td></td> <td>Graphite</td> <td>ESF.5.O.GIN.90.B.GH</td> </tr> </table> |  | Natural | ESF.5.O.GIN.90.B.NA |  | Bone | ESF.5.O.GIN.90.B.BO |  | Graphite | ESF.5.O.GIN.90.B.GH | |
|  | Natural | ESF.5.O.GIN.90.B.NA | | | | | | | | | |
|  | Bone | ESF.5.O.GIN.90.B.BO | | | | | | | | | |
|  | Graphite | ESF.5.O.GIN.90.B.GH | | | | | | | | | |
| Teak SKU |  Natural (Oiled) | ESF.5.O.GIN.90.B.TN | | | | | | | | | |

BURNER INFORMATION*

| | |
|---|---|
| Burner | XL900 |
| Fuel Type | e-NRG Bioethanol |
| Fuel Capacity | 9 Litres [2.4 Gallons] |
| Heats on Average (when used indoors) | Over 60 square metres [645 square feet] |
| Burn Time | 8 - 13 hours (approx) |
| Minimum Room Size | 110 cubic metres [3884 cubic feet] per fireplace. |

*These values are indicative only and may vary depending on the model purchased, installation, and the seasonal resource used to manufacture e-NRG.

This model comes with fixing brackets for permanently locating into a fixed position.

¹ For Indoor Use, additional parts are required. Your chosen application is the ONLY application the model can be used in due to modified configuration of the model. Please advise your Sales Representative at time of purchase so that the product can be configured accordingly.

Global Compliance

This model complies with existing standards in the USA, Europe, UK and Australia. UL Listed, EN 16647 BSI Certified ACCC Safety Mandate compliant.

¹ To comply with EN 16647 the Indoor Safety Tray and included Burner Efficiency Ring must be installed before operating indoors.

Studio image and line drawing show the optional Fire Screen accessory.

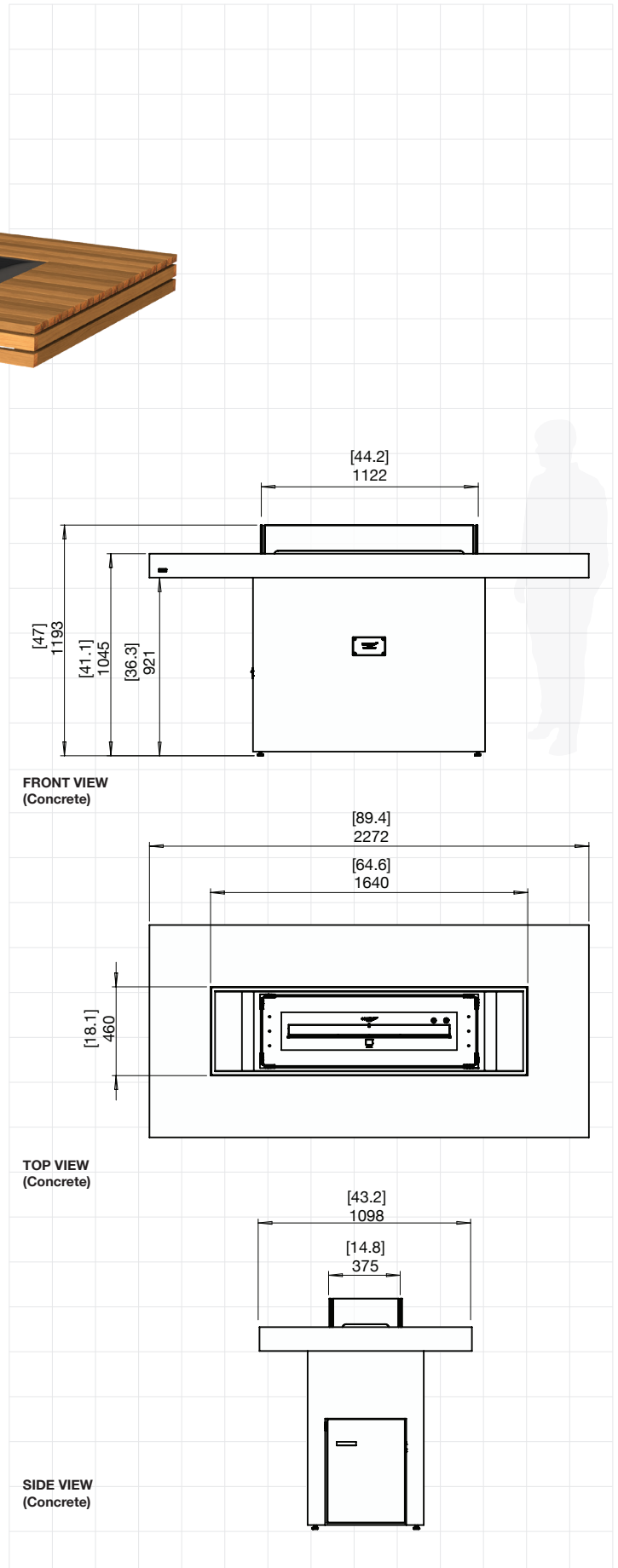







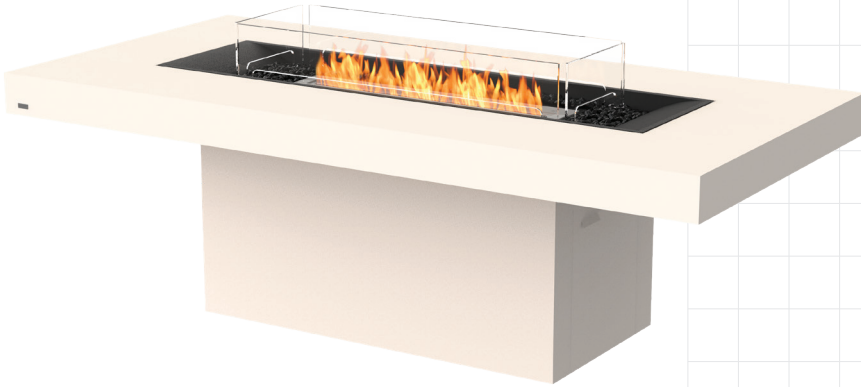



FOR MORE INFORMATION PLEASE REFERENCE THE CLEARANCE & INSTALLATION MANUAL

Disclaimer: All product specifications and data are subject to change without notice and believed to be correct at the time of publication. MAD Design Group (MDG), its affiliates, agents, and employees, and all persons acting on its or their behalf (collectively, "MAD Design Group"), disclaim any and all liability for any errors, inaccuracies or incompleteness contained herein or in any other disclosure relating to any product. MDG disclaims any and all liability arising out of the use or application of any product described herein or of any information provided herein to the maximum extent permitted by law. The product specifications do not expand or otherwise modify MDG's terms and conditions of purchase, including but not limited to the warranty expressed therein, which apply to these products. No license, express or implied, by estoppel or otherwise, to any intellectual property rights is granted by this document or by any conduct of MDG. Customers using or selling MDG products not expressly indicated for use in such applications do so entirely at their own risk and agree to fully indemnify MDG for any damages arising or resulting from such use or sale. Please contact authorized personnel from MDG to obtain written terms and conditions regarding products designed for such applications. Images are indicative only.

Gin 90 Dining



| | | | | | | | | | | | |
|---|---|---|---------|---------------------|---|------|---------------------|---|----------|---------------------|--|
| Application | Outdoor and Indoor ¹ | | | | | | | | | | |
| Materials | Fluid Concrete or Teak, Grade 304 Stainless Steel Burner, Toughened Glass Fire Screen | | | | | | | | | | |
| Weight (approx) | Concrete 172.5kg [379.5lbs] Teak 128kg [281.6lbs] Weight includes burner and accessories. | | | | | | | | | | |
| Concrete SKU's | <table border="0"> <tr> <td></td> <td>Natural</td> <td>ESF.5.O.GIN.90.D.NA</td> </tr> <tr> <td></td> <td>Bone</td> <td>ESF.5.O.GIN.90.D.BO</td> </tr> <tr> <td></td> <td>Graphite</td> <td>ESF.5.O.GIN.90.D.GH</td> </tr> </table> |  | Natural | ESF.5.O.GIN.90.D.NA |  | Bone | ESF.5.O.GIN.90.D.BO |  | Graphite | ESF.5.O.GIN.90.D.GH | |
|  | Natural | ESF.5.O.GIN.90.D.NA | | | | | | | | | |
|  | Bone | ESF.5.O.GIN.90.D.BO | | | | | | | | | |
|  | Graphite | ESF.5.O.GIN.90.D.GH | | | | | | | | | |
| Teak SKU |  Natural (Oiled) | ESF.5.O.GIN.90.D.TN | | | | | | | | | |

BURNER INFORMATION*

| | |
|---|---|
| Burner | XL900 |
| Fuel Type | e-NRG Bioethanol |
| Fuel Capacity | 9 Litres [2.4 Gallons] |
| Heats on Average (when used indoors) | Over 60 square metres [645 square feet] |
| Burn Time | 8 - 13 hours (approx) |
| Minimum Room Size | 110 cubic metres [3884 cubic feet] per fireplace. |

*These values are indicative only and may vary depending on the model purchased, installation, and the seasonal resource used to manufacture e-NRG.

This model comes with fixing brackets for permanently locating into a fixed position.

¹ For Indoor Use, additional parts are required. Your chosen application is the ONLY application the model can be used in due to modified configuration of the model. Please advise your Sales Representative at time of purchase so that the product can be configured accordingly.

Global Compliance

This model complies with existing standards in the USA, Europe, UK and Australia. UL Listed, EN 16647 BSI Certified ACCC Safety Mandate compliant.

¹ To comply with EN 16647 the Indoor Safety Tray and included Burner Efficiency Ring must be installed before operating indoors.

Studio image and line drawing show the optional Fire Screen accessory.

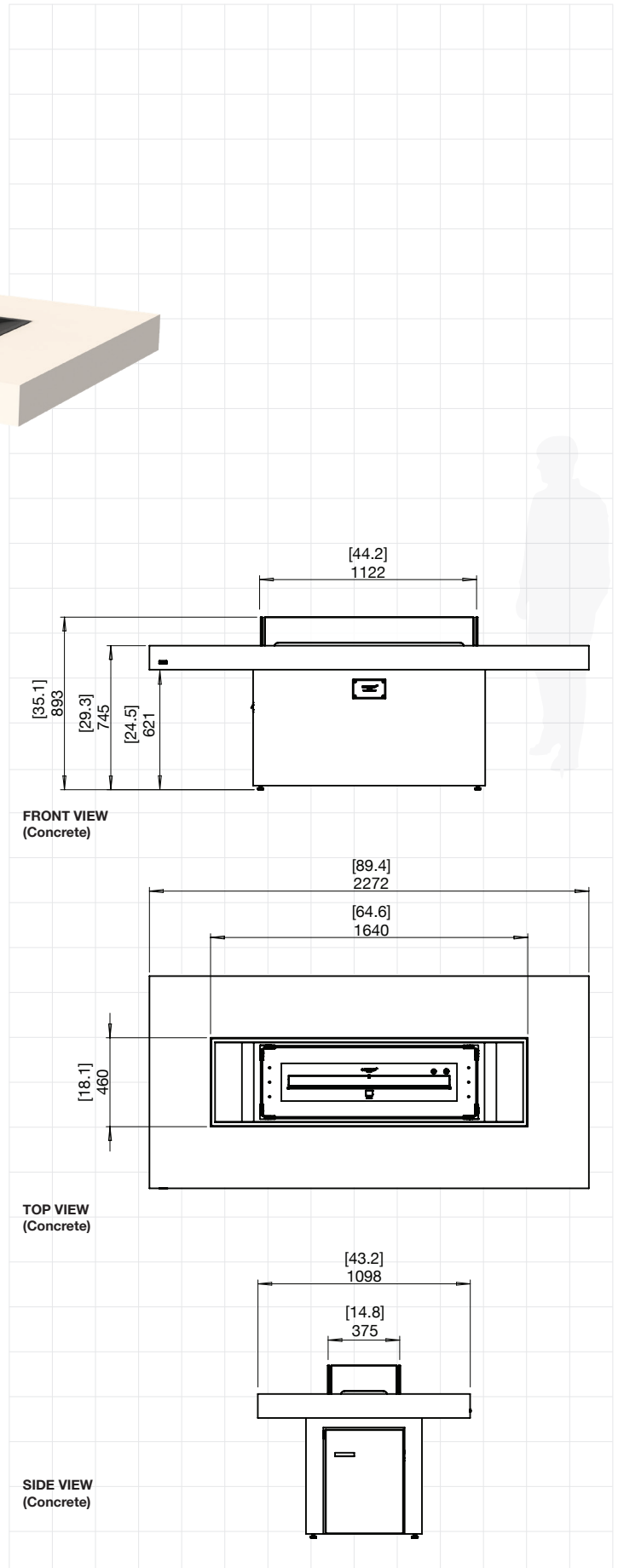











FOR MORE INFORMATION PLEASE REFERENCE THE CLEARANCE & INSTALLATION MANUAL

Disclaimer. All product specifications and data are subject to change without notice and believed to be correct at the time of publication. MAD Design Group (MDG), its affiliates, agents, and employees, and all persons acting on its or their behalf (collectively, "MAD Design Group"), disclaim any and all liability for any errors, inaccuracies or incompleteness contained herein or in any other disclosure relating to any product. MDG disclaims any and all liability arising out of the use or application of any product described herein or of any information provided herein to the maximum extent permitted by law. The product specifications do not expand or otherwise modify MDG's terms and conditions of purchase, including but not limited to the warranty expressed therein, which apply to these products. No license, express or implied, by estoppel or otherwise, to any intellectual property rights is granted by this document or by any conduct of MDG. Customers using or selling MDG products not expressly indicated for use in such applications do so entirely at their own risk and agree to fully indemnify MDG for any damages arising or resulting from such use or sale. Please contact authorized personnel from MDG to obtain written terms and conditions regarding products designed for such applications. Images are indicative only.

Gin 90 Chat



| | | | | | | | | | | |
|---|---|---|---------|---------------------|---|------|---------------------|---|----------|---------------------|
| Application | Outdoor and Indoor ¹ | | | | | | | | | |
| Materials | Fluid Concrete or Teak, Grade 304 Stainless Steel Burner, Toughened Glass Fire Screen | | | | | | | | | |
| Weight (approx) | Concrete 162.5kg [357.5lbs] Teak 119kg [261.8lbs] Weight includes burner and accessories. | | | | | | | | | |
| Concrete SKU's | <table border="0"> <tr> <td></td> <td>Natural</td> <td>ESF.5.O.GIN.90.C.NA</td> </tr> <tr> <td></td> <td>Bone</td> <td>ESF.5.O.GIN.90.C.BO</td> </tr> <tr> <td></td> <td>Graphite</td> <td>ESF.5.O.GIN.90.C.GH</td> </tr> </table> |  | Natural | ESF.5.O.GIN.90.C.NA |  | Bone | ESF.5.O.GIN.90.C.BO |  | Graphite | ESF.5.O.GIN.90.C.GH |
|  | Natural | ESF.5.O.GIN.90.C.NA | | | | | | | | |
|  | Bone | ESF.5.O.GIN.90.C.BO | | | | | | | | |
|  | Graphite | ESF.5.O.GIN.90.C.GH | | | | | | | | |
| Teak SKU |  Natural (Oiled) | ESF.5.O.GIN.90.C.TN | | | | | | | | |

BURNER INFORMATION*

| | |
|---|---|
| Burner | XL900 |
| Fuel Type | e-NRG Bioethanol |
| Fuel Capacity | 9 Litres [2.4 Gallons] |
| Heats on Average (when used indoors) | Over 60 square metres [645 square feet] |
| Burn Time | 8 - 13 hours (approx) |
| Minimum Room Size | 110 cubic metres [3884 cubic feet] per fireplace. |

*These values are indicative only and may vary depending on the model purchased, installation, and the seasonal resource used to manufacture e-NRG. This model comes with fixing brackets for permanently locating into a fixed position.

¹ For Indoor Use, additional parts are required. Your chosen application is the ONLY application the model can be used in due to modified configuration of the model. Please advise your Sales Representative at time of purchase so that the product can be configured accordingly.

Global Compliance

This model complies with existing standards in the USA, Europe, UK and Australia. UL Listed, EN 16647 BSI Certified ACCC Safety Mandate compliant. ¹ To comply with EN 16647 the Indoor Safety Tray and included Burner Efficiency Ring must be installed before operating indoors.

Studio image and line drawing show the optional Fire Screen accessory.

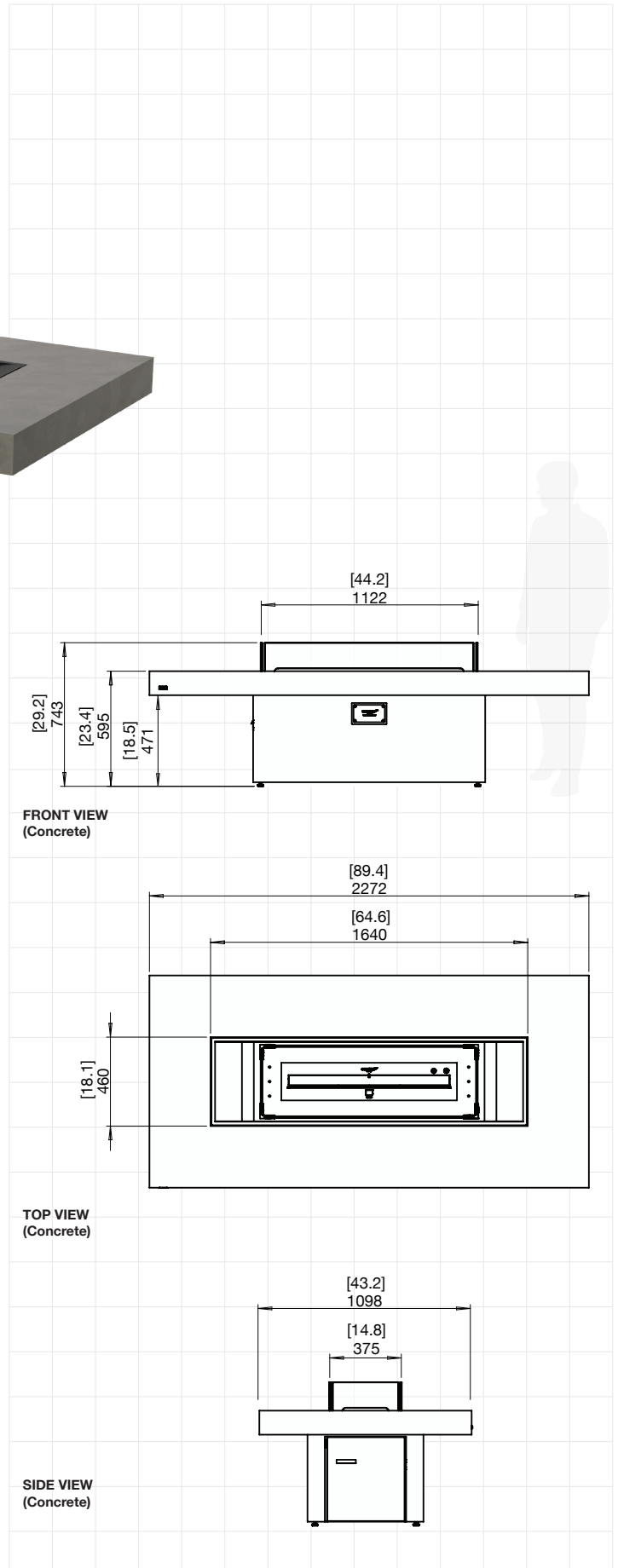







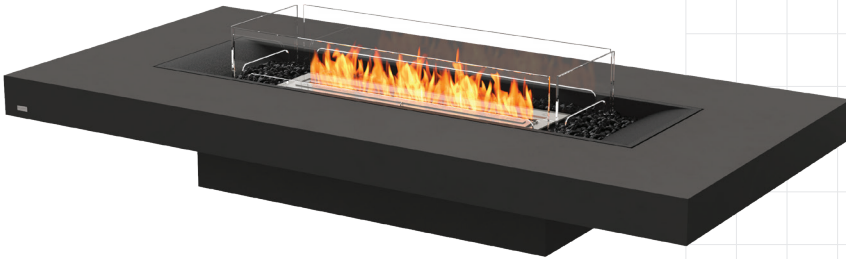



FOR MORE INFORMATION PLEASE REFERENCE THE CLEARANCE & INSTALLATION MANUAL

Disclaimer: All product specifications and data are subject to change without notice and believed to be correct at the time of publication. MAD Design Group (MDG), its affiliates, agents, and employees, and all persons acting on its or their behalf (collectively, "MAD Design Group"), disclaim any and all liability for any errors, inaccuracies or incompleteness contained herein or in any other disclosure relating to any product. MDG disclaims any and all liability arising out of the use or application of any product described herein or of any information provided herein to the maximum extent permitted by law. The product specifications do not expand or otherwise modify MDG's terms and conditions of purchase, including but not limited to the warranty expressed therein, which apply to these products. No license, express or implied, by estoppel or otherwise, to any intellectual property rights is granted by this document or by any conduct of MDG. Customers using or selling MDG products not expressly indicated for use in such applications do so entirely at their own risk and agree to fully indemnify MDG for any damages arising or resulting from such use or sale. Please contact authorized personnel from MDG to obtain written terms and conditions regarding products designed for such applications. Images are indicative only.

Gin 90 Low



| | | | | | | | | | | | |
|---|---|---|---------|---------------------|---|------|---------------------|---|----------|---------------------|--|
| Application | Outdoor and Indoor ¹ | | | | | | | | | | |
| Materials | Fluid Concrete or Teak, Grade 304 Stainless Steel Burner, Toughened Glass Fire Screen | | | | | | | | | | |
| Weight (approx) | Concrete 154.5kg [339.9lbs] Teak 100kg [220lbs] Weight includes burner and accessories. | | | | | | | | | | |
| Concrete SKU's | <table border="0"> <tr> <td></td> <td>Natural</td> <td>ESF.5.O.GIN.90.L.NA</td> </tr> <tr> <td></td> <td>Bone</td> <td>ESF.5.O.GIN.90.L.BO</td> </tr> <tr> <td></td> <td>Graphite</td> <td>ESF.5.O.GIN.90.L.GH</td> </tr> </table> |  | Natural | ESF.5.O.GIN.90.L.NA |  | Bone | ESF.5.O.GIN.90.L.BO |  | Graphite | ESF.5.O.GIN.90.L.GH | |
|  | Natural | ESF.5.O.GIN.90.L.NA | | | | | | | | | |
|  | Bone | ESF.5.O.GIN.90.L.BO | | | | | | | | | |
|  | Graphite | ESF.5.O.GIN.90.L.GH | | | | | | | | | |
| Teak SKU |  Natural (Oiled) | ESF.5.O.GIN.90.L.TN | | | | | | | | | |

BURNER INFORMATION*

| | |
|---|---|
| Burner | XL900 |
| Fuel Type | e-NRG Bioethanol |
| Fuel Capacity | 9 Litres [2.4 Gallons] |
| Heats on Average (when used indoors) | Over 60 square metres [645 square feet] |
| Burn Time | 8 - 13 hours (approx) |
| Minimum Room Size | 110 cubic metres [3884 cubic feet] per fireplace. |

*These values are indicative only and may vary depending on the model purchased, installation, and the seasonal resource used to manufacture e-NRG.

This model comes with fixing brackets for permanently locating into a fixed position.

¹ For Indoor Use, additional parts are required. Your chosen application is the ONLY application the model can be used in due to modified configuration of the model. Please advise your Sales Representative at time of purchase so that the product can be configured accordingly.

Global Compliance

This model complies with existing standards in the USA, Europe, UK and Australia. UL Listed, EN 16647 BSI Certified ACCC Safety Mandate compliant.

¹ To comply with EN 16647 the Indoor Safety Tray and included Burner Efficiency Ring must be installed before operating indoors.

Studio image and line drawing show the optional Fire Screen accessory.

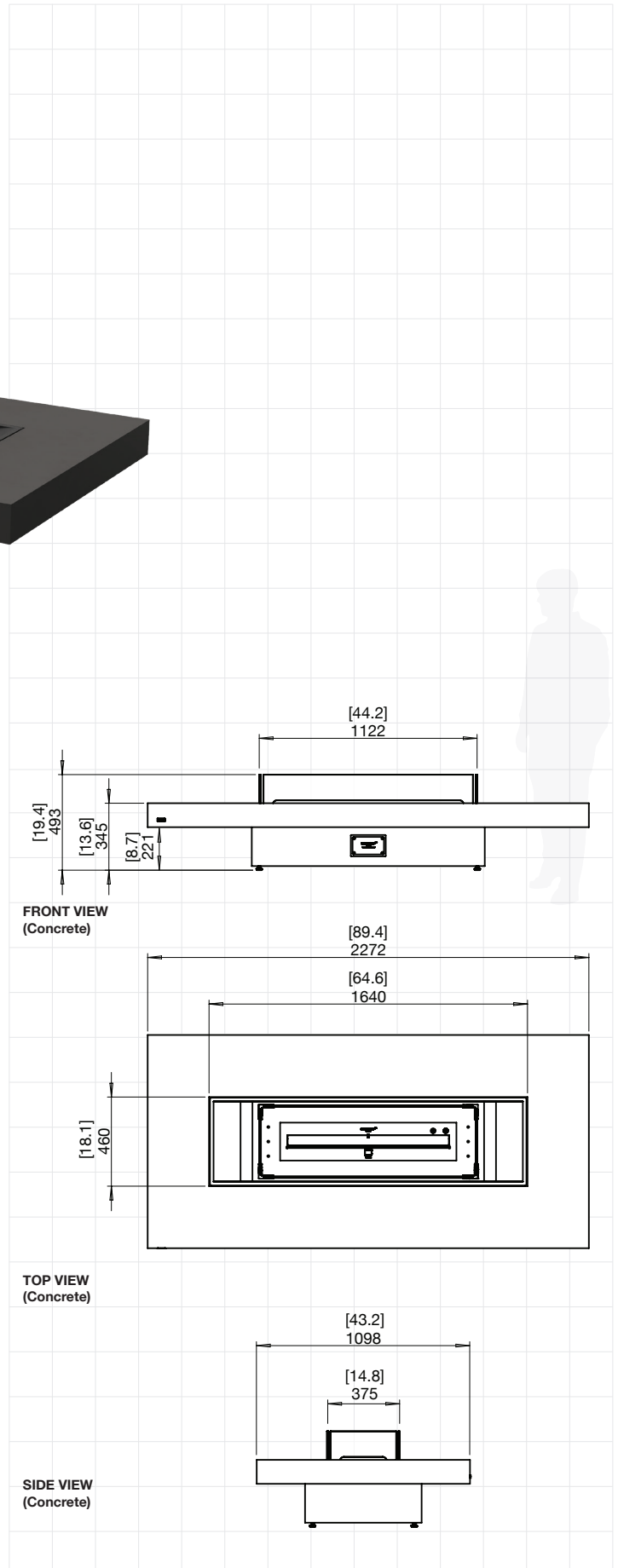

FOR MORE INFORMATION PLEASE REFERENCE THE CLEARANCE & INSTALLATION MANUAL

Disclaimer. All product specifications and data are subject to change without notice and believed to be correct at the time of publication. MAD Design Group (MDG), its affiliates, agents, and employees, and all persons acting on its or their behalf (collectively, "MAD Design Group"), disclaim any and all liability for any errors, inaccuracies or incompleteness contained herein or in any other disclosure relating to any product. MDG disclaims any and all liability arising out of the use or application of any product described herein or of any information provided herein to the maximum extent permitted by law. The product specifications do not expand or otherwise modify MDG's terms and conditions of purchase, including but not limited to the warranty expressed therein, which apply to these products. No license, express or implied, by estoppel or otherwise, to any intellectual property rights is granted by this document or by any conduct of MDG. Customers using or selling MDG products not expressly indicated for use in such applications do so entirely at their own risk and agree to fully indemnify MDG for any damages arising or resulting from such use or sale. Please contact authorized personnel from MDG to obtain written terms and conditions regarding products designed for such applications. Images are indicative only.