

CLEARANCES AND INSTALLATION MANUAL

Please read these instructions completely before installing or operating the EcoSmart™ Fire.

FLEX FIREPLACES

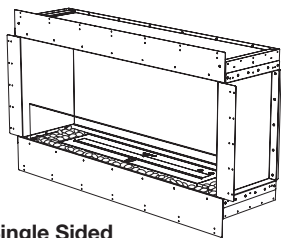

Single Sided

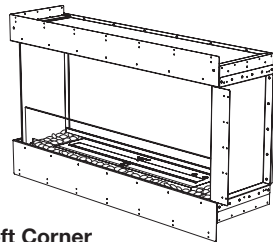

Left Corner

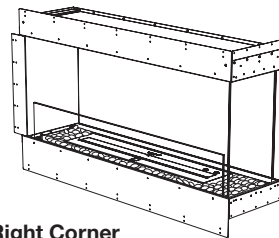

Right Corner

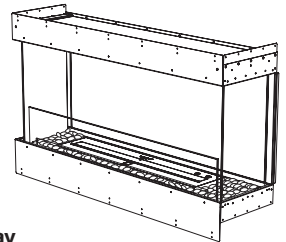

Bay

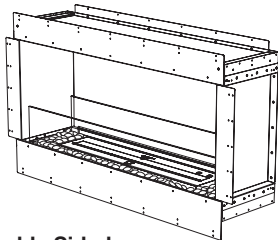

Double Sided

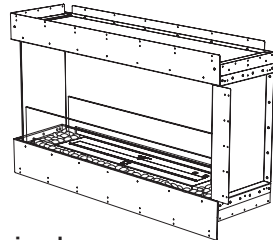

Peninsula

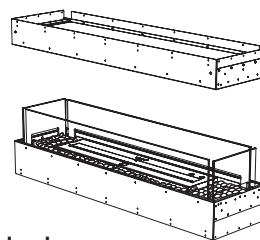

Island

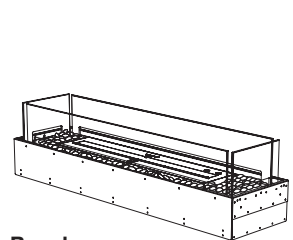

Bench

e-nrg[®]
natural . renewable . green

e-NRG bioethanol is the
ONLY fuel to be used in
this appliance.

! WARNINGS:

IF THE INFORMATION IN THIS MANUAL IS NOT FOLLOWED EXACTLY, A FIRE OR EXPLOSION MAY RESULT CAUSING PROPERTY DAMAGE, PERSONAL INJURY OR LOSS OF LIFE.



Do not fill while hot



Do not fill while operating



Do not overfill



Flammable

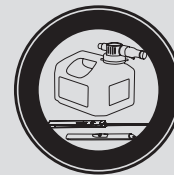

Use with supplied accessories



Keep away from children

Table of Contents

ENGLISH Clearances and Installation Manual	1
Please read these instructions completely before installing or operating the EcoSmart™ Fire.	
DEUTSCH Clearances and Installation Manual	21
Please read these instructions completely before installing or operating the EcoSmart™ Fire.	
FRANÇAIS Manuel d'installation et de dégagements minimaux	41
Veillez lire ces instructions dans leur intégralité avant d'utiliser votre produit EcoSmart™ Fire.	
中文 预留间隙与安装指示	61
请在安装使用EcoSmart Fire®的产品前，仔细阅读说明书以确保产品在最安全的状态下使用。	
ITALIANO Distanze e manuale di installazione	81
Leggere attentamente queste istruzioni prima di installare o utilizzare Ecosmart™ Fire.	
ESPAÑOL Manual de instalación y distancias mínimas	101
Por favor, lea las instrucciones completamente antes de utilizar el EcoSmart™ Fire.	

Appliance Clearances

SELECTING APPLIANCE LOCATION	2
VENTILATION	2
MINIMUM ROOM SIZE	2

Appliance Installation

FRAMING	3
BEFORE GETTING STARTED	4
SINGLE SIDED INSTALLATION	5 - 6
LEFT CORNER INSTALLATION	7 - 8
RIGHT CORNER INSTALLATION	7 - 8
BAY INSTALLATION	9 - 10
DOUBLE SIDED INSTALLATION	11 - 12
PENINSULA INSTALLATION	13 - 14
BENCH INSTALLATION	15 - 16
ISLAND INSTALLATION	17 - 18
FINISHING	19
MANTEL SURROUNDS	20
DECORATIVE BOX INFILL PLATE	20

These appliances are manufacturer approved for use only with the accompanying UL Listed Burner/s.

OPERATION

Refer to the Operations Manual included with the Burner.

Appliance Clearances

Please read these instructions completely before installing and operating the EcoSmart™ Fire.

SELECTING APPLIANCE LOCATION

The appliance is zero clearance and has the necessary clearances to combustible frame components already built-in. They are engineered specifically to accept compatible EcoSmart Fire Burners.

When selecting a location for the appliance it is important to consider the required minimum room sizes and clearances to walls and combustible materials (see Clearances images below and Minimum Room Size table).

Note: Flex appliances are made from zinc sealed steel which is powder coated with super hi-temp black paint which prevents rusting. The burners are made of 304 stainless steel. To ensure the burner(s) continue looking great and to avoid rust or corrosion it is important any contamination or debris are cleaned or removed from the burner immediately.

If installed outdoors, the appliance must be located under a protective overhang to avoid it from filling with water and being permanently damaged. The warranty is void if the product is damaged as a result of installation in an exposed location.

When not in use, keep the burner lid closed to safeguard the burner from debris falling into the burner chamber and causing contamination.

WARNING: Risk of Fire or Burns! Provide adequate clearance around air openings and for service access. Observe the clearances to combustibles recommended in this manual and the burner manual. Ensure that your fire is positioned away from flammable materials and other sources of ignition at all times. Due to high temperatures, the appliance should be located out of traffic and away from furniture and draperies. Pay very close attention to positioning the fire away from items that may move as a result of wind and drafts. For example trees/branches/curtains/paper and the like. Keep children at a safe distance at all times and never leave them unsupervised when the appliance is on or hot.

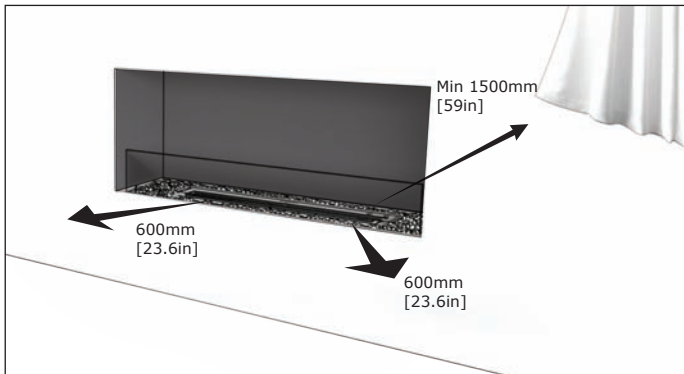

Indoor Clearances

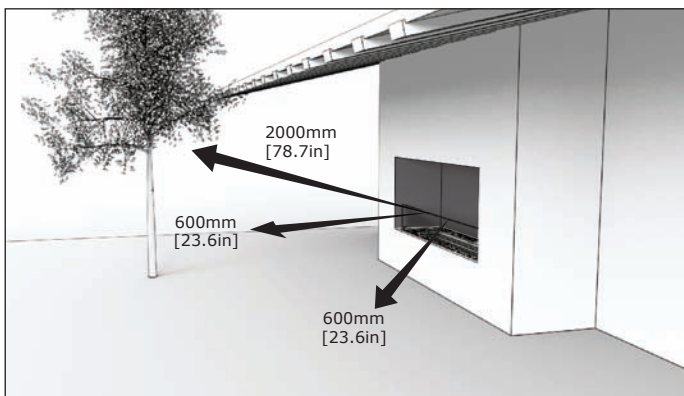

Outdoor Clearances (Need overhang or "roof extension" above the fireplace to ensure rain will not enter the firebox. Check with local building codes regarding requirements for overhangs / roof extensions.)

VENTILATION

EcoSmart Fires do not require any form of permanent fixture or fitting, such as a flue for ventilation, a permanent connection or any kind of fixed utility for fuel supply.

Do not cover any existing ventilation systems or structures that are built or installed within the chosen installation area.

To ensure adequate ventilation, make sure to follow the guidelines in the table shown.

Underwriters Laboratories (UL) calculates adequate air exchange as follows:

In a house of typical construction, that is, one that is not of unusually tight construction due to heavy insulation and tight seals against air infiltration, an adequate supply of air for combustion and ventilation is provided through infiltration. However, if the Burner is used in a small room where less than **5.7m³ [200ft³]** of air space is provided for each **1000 BTU** per hour of appliance rating (considering the maximum Burner setting), the door(s) to adjacent room(s) should be kept open or a window to the outside should be opened at least **25.4mm [1in]** to guard against potential build up of indoor air pollution. Do not install or operate in a bathroom or any other small room.

MINIMUM ROOM SIZE

Ventilation table based on number of burners (per appliance).

Appliance	Burner/s	Minimum Room Size	BTU
FLEX18	1x AB3	1413 cubic feet (40 cu. meters)	5,800
FLEX32 FLEX50.BX FLEX68.BX2	1x XL500	2825 cubic feet (80 cu. meters)	11,430
FLEX42 FLEX60.BX FLEX78.BX2	1x XL700	3178 cubic feet (90 cu. meters)	13,650
FLEX50 FLEX68.BX FLEX86.BX2	1x XL900	3884 cubic feet (110 cu. meters)	15,000
FLEX68 FLEX86.BX FLEX104.BX2	1x XL1200	4061 cubic feet (115 cu. meters)	16,200
FLEX86 FLEX104.BX FLEX122.BX2	2x XL900	7768 cubic feet (220 cu. meters)	30,000
FLEX104 FLEX122.BX FLEX140.BX2	2x XL1200	8122 cubic feet (230 cu. meters)	32,400
FLEX122 FLEX140.BX FLEX158.BX2	3x XL900	11652 cubic feet (330.2 cu. meters)	45,000
FLEX158	3x XL1200	12183 cubic feet (345 cu. meters)	48,600

NOT INTENDED FOR USE AS A PRIMARY HEAT SOURCE. This appliance is tested and approved as either a supplemental room heat or as a decorative appliances. It should not be factored as primary heat in residential heating calculations.

Appliance Installation

These appliances must be installed into a fixed secure position before being operated.

NOTICE: DO NOT INSTALL DIRECTLY BESIDE OR NEAR WALLPAPER, LAMINATE, VENEER OR ANY SURFACE THAT IS NOT DESIGNED TO WITHSTAND HEAT AND HIGH TEMPERATURES (the heat will impact the material, and in some circumstances the glue used for its application). THE AREA AROUND THE APPLIANCE GETS HOT. HEAT SENSITIVE/REACTIVE MATERIALS SHOULD NOT BE USED. DO NOT PLACE FLAMMABLE OBJECTS ON OR AROUND THE APPARATUS.

These appliances are not designed to incorporate doors or opening covers.

The appliance must remain open at all times for ventilation – it is not designed to operate as an oven or similar “hot box” – the flame must have a constant supply of air to operate and be able to circulate and distribute the heat effectively

DO NOT PACK REQUIRED AIR SPACES (the space between the appliance and the spacer) WITH INSULATION OR OTHER MATERIALS. THE AIR SPACERS ARE NEEDED TO ENSURE PROPER TEMPERATURES ARE MAINTAINED BEHIND THE APPLIANCE.

Do not modify the appliance in any way during installation. Cutting of sheet metal parts of the appliance is prohibited.

Expansion and contraction of internal parts due to heating and cooling off may create noise. This is normal.

WARNING: DO NOT OPERATE WITHOUT THE GLASS WINDSCREEN

The appliance must be fully assembled before being operated. Failure to install (or removal of) glass panels will void the warranty and render the product unapproved for use with the included burner.

FRAMING

Important Considerations for Framing

1. The appliance must be installed on a level surface capable of supporting the appliance, burner, glass charcoal and full fuel capacity.
2. The framing dimensions shown in the instructions are the optimum dimensions that allow best fit with gyprock / sheetrock / plasterboard (or other facing/finishing material) after the appliance has been installed.
3. Prepare the installation location. If placing the appliance on a platform, build the platform, making sure to accommodate the weight of the appliance, burner, glass charcoal and fuel. Verify that the platform is level.

In the case of insufficient capacity to hold the weight of the appliance, measures must be taken to reinforce the setting (for example installation of a plate for load distribution) so that the setting is suitable for installation.

IMPORTANT: The framing above the appliance must be self-supporting. The appliance is not load-bearing.

DEFINITIONS

Combustible materials - Materials made of or surfaced with wood, compressed paper, plant fibers, plastics, or other material that can ignite and burn, whether flame produced or not, or plastered or unplastered shall be considered combustible materials.

Non-combustible materials - materials which will not ignite and burn. Such materials are those consisting entirely of steel, iron, brick, tile, concrete, slate, glass or plasters, or any combination thereof. HardieBacker®, WonderBoard®, Durock® or materials that are reported as passing ASTM E 136, Standard Test Method for Behavior of Materials in a Vertical Tube Furnace at 750C shall be considered non-combustible materials.

NOTE: Illustrations reflect typical installations and are for DESIGN PURPOSES ONLY. Illustrations/diagrams are not drawn to scale. Actual installation may vary due to individual design preferences.

Appliance Installation

BEFORE GETTING STARTED

1. Carefully remove the appliance and components from the packaging
2. Inspect and report any parts damaged in shipment, particularly the condition of the glass windscreen.
3. Read all of the instructions before starting the installation. Follow these instructions carefully during the installation to ensure maximum safety and benefit.

WARNING: Risk of fire or explosion! Damaged parts could impair safe operation. Do not install damaged, incomplete or substitute components.

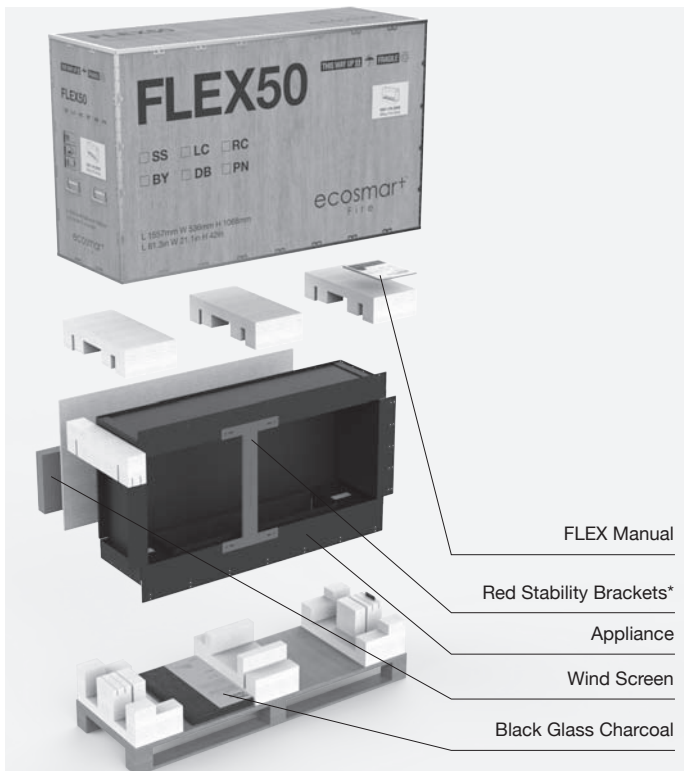

Appliance Crate

* Not applicable to Flex Bench models.

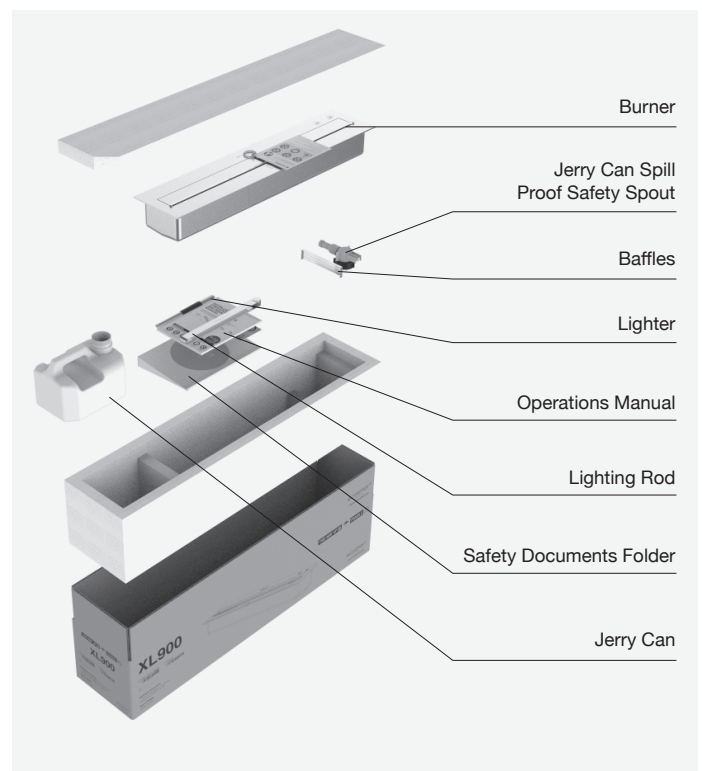

Burner Carton

Single Sided Installation

Equipment required: Power Drill, Screwdriver, Level, Hand Trowel for Plaster, Silicone Gun, Caulk Gun

1. Construct the main wall framework with the opening size shown in Table A. The base of the frame can be a solid bench/platform, which will assist in leveling up the appliance when in position.



Table A: Framework Opening Sizes

Physical appliance dimensions should be verified against cut out dimensions BEFORE installation begins to confirm tolerances align.

APPLIANCE	W mm [in]	D mm [in]	H mm [in]	Weight* kg [lbs]
FLEX18SS	488 [19.2]	365 [14.4]	730 [28.7]	25.7 [56.5]
FLEX32SS	922 [36.3]	365 [14.4]	730 [28.7]	45.7 [100.5]
FLEX42SS	1177 [46.3]	365 [14.4]	730 [28.7]	60 [131.9]
FLEX50SS	1380 [54.3]	365 [14.4]	730 [28.7]	71.4 [157.1]
FLEX50SS.BX	1380 [54.3]	365 [14.4]	730 [28.7]	69.9 [153.8]
FLEX60SS.BX	1634 [64.3]	365 [14.4]	730 [28.7]	83.9 [184.6]
FLEX68SS	1840 [72.4]	365 [14.4]	730 [28.7]	97.1 [213.6]
FLEX68SS.BX	1840 [72.4]	365 [14.4]	730 [28.7]	95.1 [209.2]
FLEX68SS.BX2	1840 [72.4]	365 [14.4]	730 [28.7]	93.9 [206.7]
FLEX78SS.BX2	2090 [82.3]	365 [14.4]	730 [28.7]	107.8 [237.1]
FLEX86SS	2300 [90.5]	365 [14.4]	730 [28.7]	121.5 [267.3]
FLEX86SS.BX	2300 [90.5]	365 [14.4]	730 [28.7]	119.4 [262.7]
FLEX86SS.BX2	2300 [90.5]	365 [14.4]	730 [28.7]	118.8 [261.4]
FLEX104SS	2760 [108.7]	365 [14.4]	730 [28.7]	146.2 [321.6]
FLEX104SS.BX	2760 [108.7]	365 [14.4]	730 [28.7]	145.2 [319.4]
FLEX104SS.BX2	2760 [108.7]	365 [14.4]	730 [28.7]	193.8 [426.4]
FLEX122SS	3220 [126.7]	365 [14.4]	730 [28.7]	171.5 [377.3]
FLEX122SS.BX	3220 [126.7]	365 [14.4]	730 [28.7]	170.1 [374.2]
FLEX122SS.BX2	3220 [126.7]	365 [14.4]	730 [28.7]	168.9 [371.6]
FLEX140SS.BX	3680 [144.9]	365 [14.4]	730 [28.7]	195.2 [429.4]
FLEX140SS.BX2	3680 [144.9]	365 [14.4]	730 [28.7]	193.8 [426.4]
FLEX158SS	4140 [163]	365 [14.4]	730 [28.7]	222.1 [488.6]
FLEX158SS.BX2	4140 [163]	365 [14.4]	730 [28.7]	218.9 [481.6]

* Appliance weight includes burner/s (dry weight excluding fuel), glass charcoal and glass. It does NOT include glass charcoal for side boxes.

IMPORTANT: The framing above the appliance must be self-supporting. The appliance is not load-bearing.

2. Slide the appliance inside the framing cavity (the base of the appliance can sit directly on top of the 2 x 4 framing material). The appliance is shipped with red stability bracket(s) installed on the open side(s) to keep the appliance square while in transport and during installation. Keep the bracket(s) on while framing up the setting to assist in minimizing movement of the appliance.

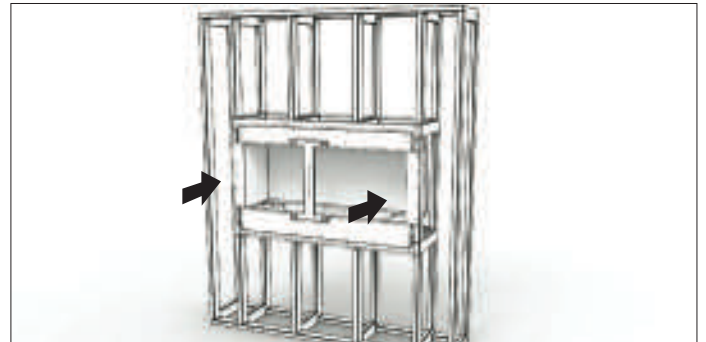

3. Secure the appliance to the framework with screws using the existing mounting holes on the appliance flanges. Make sure that the appliance is level before securing it in place.



4. Remove the red stability brackets.

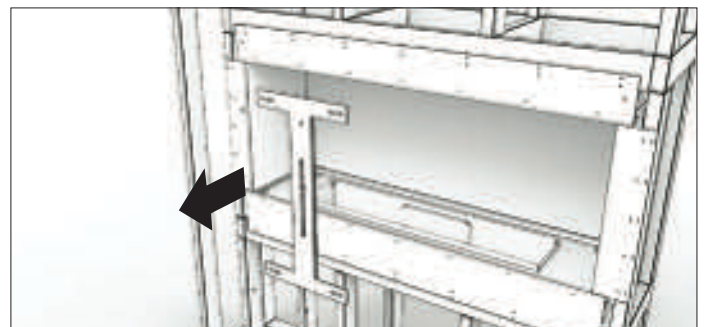

Single Sided Installation

6

5. Complete the construction by finishing the wall paneling around the appliance. (See section on **FINISHING INSTRUCTIONS** and ensure that you fully understand where non combustible materials must be used.)

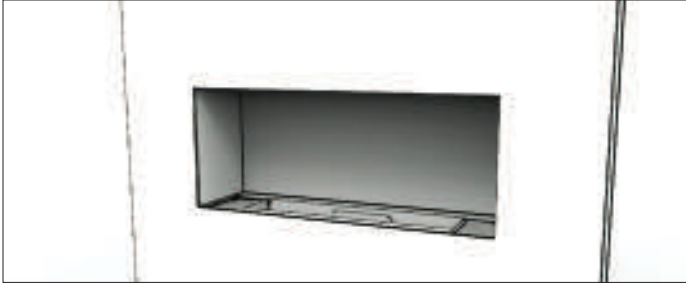

6. Place the burner into position.



7. Remove the dust protective tape that covers the windscreen mounting slots.

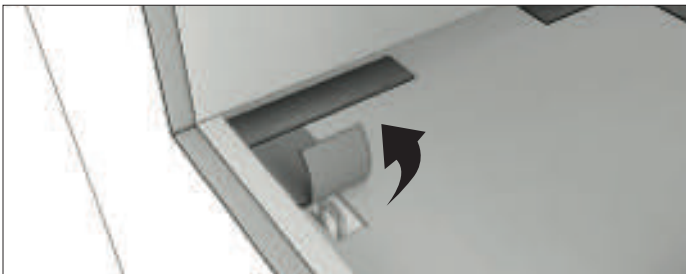

8. If your appliance includes a decorative box on the left / right or both, insert the internal glass panel/s by feeding the glass upwards into the slot then pushing down into the positioned clips.

**Decorative logs must NOT be placed directly over an open flame. They are designed to sit near heat but not over flames.*

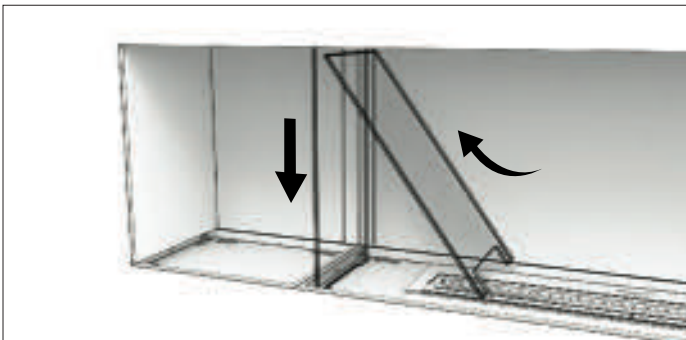

9. Install the windscreen by inserting the two ends into the appropriate slots in the appliance. Use a small amount of pressure to push the windscreen in place until it bottoms out into the hidden glass clips.

WARNING: The glass used is toughened glass - which means it is stronger than normal glass. Importantly, even though it is stronger, toughened glass still has weaknesses. The corners and sides are specific pressure points where it is more fragile and can break if care is not taken. Glass breaks into many small pieces. Take care to avoid cuts. We recommend you wear protective gloves when handling glass.

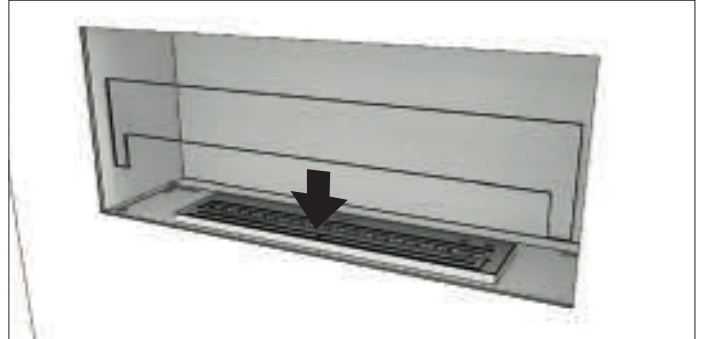

10. Spread the glass charcoal evenly around the appliance tray.
CAUTION: Make sure the burner lid is closed. Keep the glass charcoal away from the burner flange to avoid glass charcoal from accidentally going into the burner chamber. Be careful not to scratch the burner.

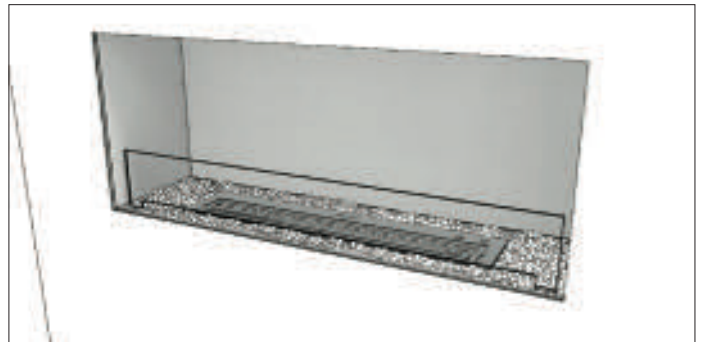

Left Corner & Right Corner Installation

Equipment required: Power Drill, Screwdriver, Level, Hand Trowel for Plaster, Silicone Gun, Caulk Gun

1. Construct a main wall framework leaving an opening as shown in Table B. The base of the frame can be a solid bench/platform, which will assist in leveling up the appliance when in position.
NOTE: Illustrations are of Left Corner installation.



Table B: Framework Opening Sizes

Physical appliance dimensions should be verified against cut out dimensions BEFORE installation begins to confirm tolerances align.

APPLIANCE (LC & RC)	W mm [in]	D mm [in]	H mm [in]	Weight* kg [lbs]
FLEX18LC	470 [18.5]	365 [14.4]	730 [28.7]	33 [72.6]
FLEX32LC	902 [35.5]	365 [14.4]	730 [28.7]	48.8 [107.4]
FLEX42LC	1157 [45.5]	365 [14.4]	730 [28.7]	63.3 [139.3]
FLEX50LC	1362 [53.6]	365 [14.4]	730 [28.7]	71.6k [157.5]
FLEX50LC.BX	1362 [53.6]	365 [14.4]	730 [28.7]	73.1 [160.8]
FLEX60LC.BX	1617 [63.7]	365 [14.4]	730 [28.7]	87.1 [191.6]
FLEX68LC	1822 [71.7]	365 [14.4]	730 [28.7]	100.3 [220.7]
FLEX68LC.BX	1822 [71.7]	365 [14.4]	730 [28.7]	95.3 [209.7]
FLEX68LC.BX2	1822 [71.7]	365 [14.4]	730 [28.7]	97kg [213.4]
FLEX78LC.BX2	2077 [81.8]	365 [14.4]	730 [28.7]	111 [244.2]
FLEX86LC	2282 [89.8]	365 [14.4]	730 [28.7]	121.7 [267.7]
FLEX86LC.BX	2282 [89.8]	365 [14.4]	730 [28.7]	122.6 [269.7]
FLEX86LC.BX2	2282 [89.8]	365 [14.4]	730 [28.7]	119 [261.8]
FLEX104LC	2742 [107.9]	365 [14.4]	730 [28.7]	149.5 [328.9]
FLEX104LC.BX	2742 [107.9]	365 [14.4]	730 [28.7]	145.4 [319.9]
FLEX104LC.BX2	2742 [107.9]	365 [14.4]	730 [28.7]	146.9 [323.2]
FLEX122LC	3202 [126.1]	365 [14.4]	730 [28.7]	171.7 [377.7]
FLEX122LC.BX	3202 [126.1]	365 [14.4]	730 [28.7]	173.4 [381.5]
FLEX122LC.BX2	3202 [126.1]	365 [14.4]	730 [28.7]	169.1 [372]
FLEX140LC.BX	3662 [144.2]	365 [14.4]	730 [28.7]	197.1 [433.6]
FLEX140LC.BX2	3662 [144.2]	365 [14.4]	730 [28.7]	195.4 [429.9]
FLEX158LC	4122 [162.3]	365 [14.4]	730 [28.7]	225.5 [496.1]
FLEX158LC.BX2	4122 [162.3]	365 [14.4]	730 [28.7]	219.1 [482]

* Appliance weight includes burner/s (dry weight excluding fuel), glass charcoal and glass. It does NOT include glass charcoal for side boxes.

2. Slide the appliance inside the framing cavity (the base of the appliance can sit directly on top of the 2 x 4 framing material). The appliance is shipped with red stability bracket(s) installed on the open side(s) to keep the appliance square while in transport and during installation. Keep the bracket(s) on while framing up the setting to assist in minimising movement of the appliance. Align the top corner flange extension panel with the threaded holes on top shelf and screw into place with the included screws

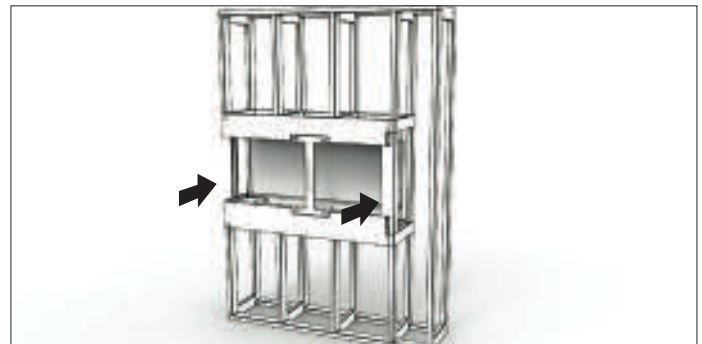

3. Secure the appliance to the framework using the existing mounting holes on the appliance flanges. Make sure that the appliance is level before securing it in place.



4. Remove the red safety bracket(s).

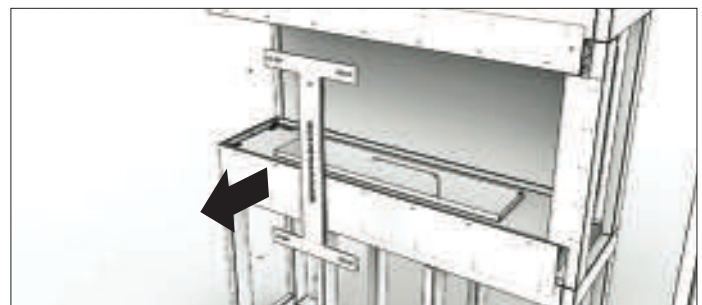

IMPORTANT: The framing above the appliance must be self-supporting. The appliance is not load-bearing.

Left Corner & Right Corner Installation



5. Complete the construction by finishing the wall paneling around the appliance. (See section on **FINISHING INSTRUCTIONS** and ensure that you fully understand where non combustible materials must be used.)



6. Place the burner into position.

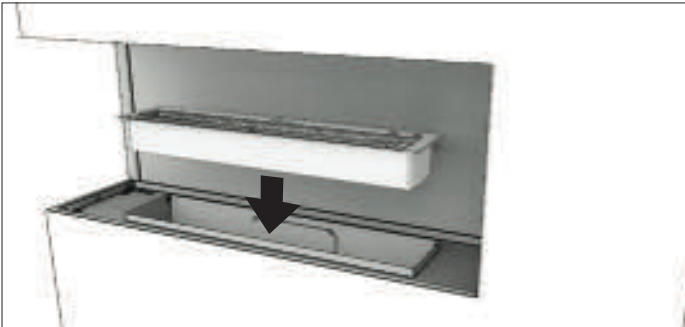

7. Remove the dust protective tape that covers the windscreen mounting slots.

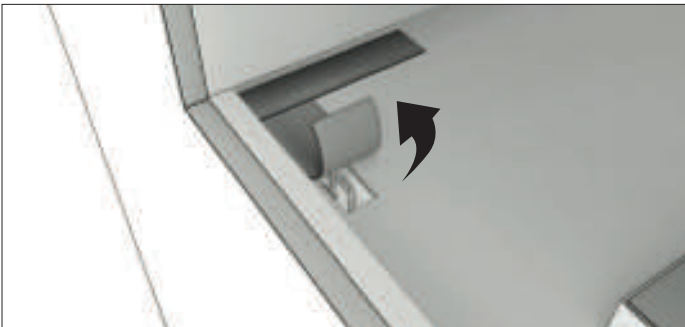

8. If your appliance includes a decorative box on the left / right or both, insert the internal glass panel by feeding the glass upwards into the slot then pushing down into the positioned clips.

**Decorative logs must NOT be placed directly over an open flame. They are designed to sit near heat but not over flames.*

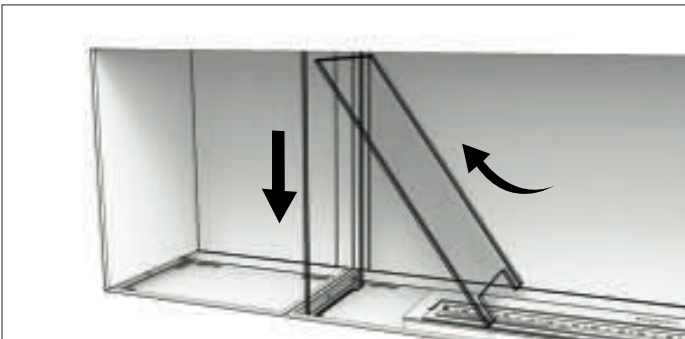

9. Insert the full height glass panel into one of the open end side by inserting the glass into the opening at the top of the appliance, and lowering it into the slots in the base until it bottoms out into place.



10. Install the windscreen by inserting the glass ends into the slots. Use a small amount of pressure to push the windscreen in place until it bottoms out into the hidden glass clips.

WARNING: The glass used is toughened glass - which means it is stronger than normal glass. Importantly, even though it is stronger, toughened glass still has weaknesses. The corners and sides are specific pressure points where it is more fragile and can break if care is not taken. Glass breaks into many small pieces. Take care to avoid cuts. We recommend you wear protective gloves when handling glass.

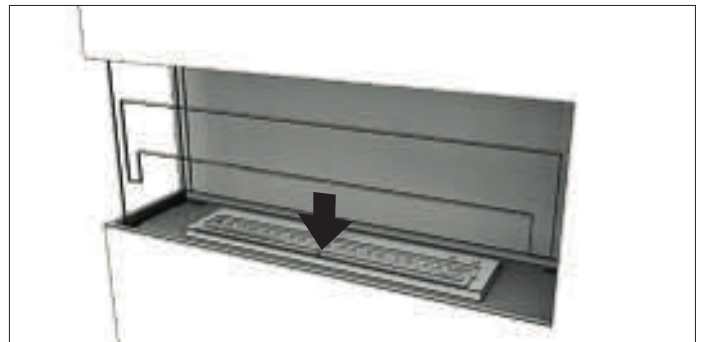

11. Spread the glass charcoal evenly around the appliance tray.
CAUTION: Make sure the burner lid is closed. Keep the glass charcoal away from the burner flange to avoid glass charcoal from accidentally going into the burner chamber. Be careful not to scratch the burner.

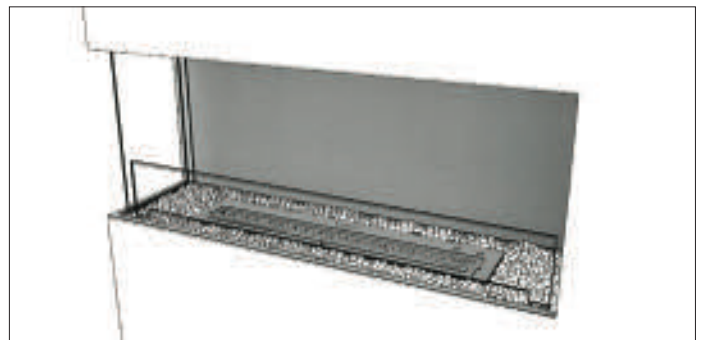

Bay Installation

Equipment required: Power Drill, Screwdriver, Level, Hand Trowel for Plaster, Silicone Gun, Caulk Gun

1. Construct a main wall framework leaving an opening as shown in Table C. The base of the frame can be a solid bench/platform, which will assist in leveling up the appliance when in position.



Table C: Framework Opening Sizes

Physical appliance dimensions should be verified against cut out dimensions BEFORE installation begins to confirm tolerances align.

APPLIANCE	W mm [in.]	D mm [in.]	H mm [in.]	Weight* kg [lbs]
FLEX18BY	460 [18.1]	365 [14.4]	730 [28.7]	40.7 [89.5]
FLEX32BY	892 [35.1]	365 [14.4]	730 [28.7]	51.9 [114.2]
FLEX42BY	1147 [45.2]	365 [14.4]	730 [28.7]	66.5 [146.3]
FLEX50BY	1352 [53.2]	365 [14.4]	730 [28.7]	71.8 [158]
FLEX50BY.BX	1353 [53.3]	365 [14.4]	730 [28.7]	76.2 [167.6]
FLEX60BY.BX	1608 [63.3]	365 [14.4]	730 [28.7]	90.3 [198.7]
FLEX68BY	1813 [71.4]	365 [14.4]	730 [28.7]	103.6 [227.9]
FLEX68BY.BX	1813 [71.4]	365 [14.4]	730 [28.7]	95.5 [210.1]
FLEX68BY.BX2	1813 [71.4]	365 [14.4]	730 [28.7]	100.2 [220.4]
FLEX78BY.BX2	2068 [81.4]	365 [14.4]	730 [28.7]	114 [250.8]
FLEX86BY	2272 [89.4]	365 [14.4]	730 [28.7]	121.9 [268.2]
FLEX86BY.BX	2272 [89.4]	365 [14.4]	730 [28.7]	125.9 [277]
FLEX86BY.BX2	2272 [89.4]	365 [14.4]	730 [28.7]	119.2 [262.2]
FLEX104BY	2733 [107.6]	365 [14.4]	730 [28.7]	152.9 [336.4]
FLEX104BY.BX	2733 [107.6]	365 [14.4]	730 [28.7]	145.6 [320.3]
FLEX104BY.BX2	2733 [107.6]	365 [14.4]	730 [28.7]	150.1 [330.2]
FLEX122BY	3193 [125.7]	365 [14.4]	730 [28.7]	171.9 [378.2]
FLEX122BY.BX	3193 [125.7]	365 [14.4]	730 [28.7]	176.7 [388.7]
FLEX122BY.BX2	3193 [125.7]	365 [14.4]	730 [28.7]	169.3 [372.5]
FLEX140BY.BX	3653 [143.8]	365 [14.4]	730 [28.7]	195.6 [430.3]
FLEX140BY.BX2	3653 [143.8]	365 [14.4]	730 [28.7]	200.3 [440.7]
FLEX158BY	4113 [161.9]	365 [14.4]	730 [28.7]	228.8 [503.4]
FLEX158BY.BX2	4113 [161.9]	365 [14.4]	730 [28.7]	219.3[482.5]

* Appliance weight includes burner/s (dry weight excluding fuel), glass charcoal and glass. It does NOT include glass charcoal for side boxes.

IMPORTANT: The framing above the appliance must be self-supporting. The appliance is not load-bearing.

2. Slide the appliance inside the framing cavity (the base of the appliance can sit directly on top of the 2 x 4 framing material). The appliance is shipped with red stability bracket(s) installed on the open side(s) to keep the appliance square while in transport and during installation. Keep the bracket(s) on while framing up the setting to assist in minimising movement of the appliance.

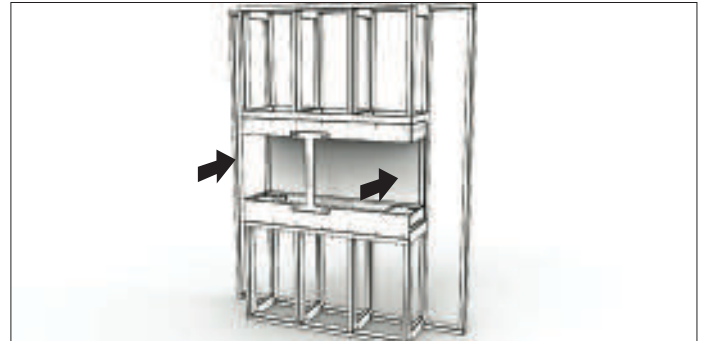

3. Ensure that the left and right side edges of the appliance are flush to the frame-work studs.

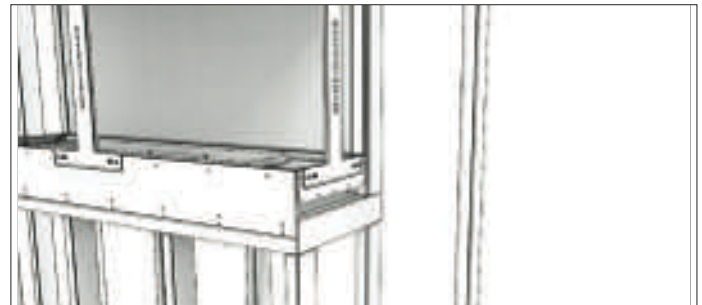

4. Secure the appliance to the framework with screws using the existing mounting holes on the appliance flanges. Make sure that the appliance is level before securing it in place.



5. Remove the red stability brackets.

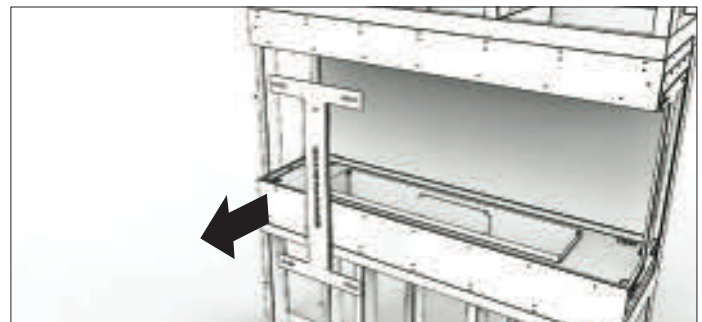

Bay Installation

10

6. Complete the construction by finishing the wall paneling around the appliance. (See section on **FINISHING INSTRUCTIONS** and ensure that you fully understand where non combustible materials must be used.)

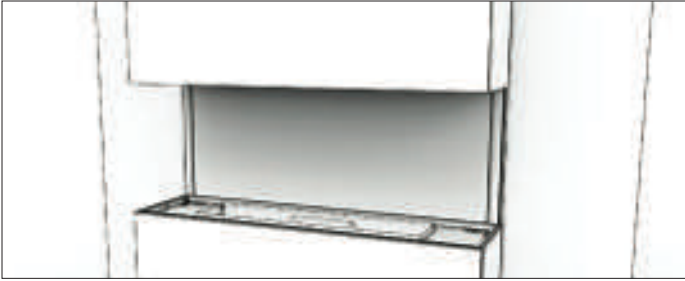

7. Place the burner into position.

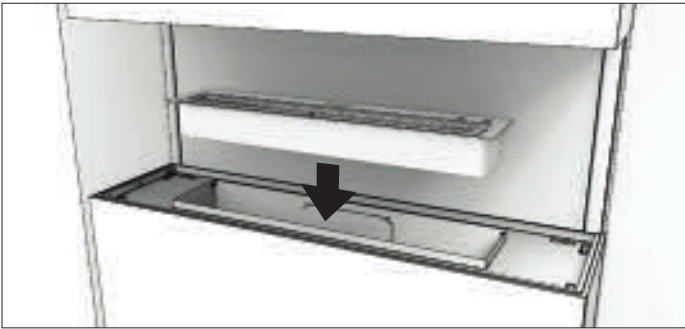

8. Remove the dust protective tape that covers the windscreen mounting slots.

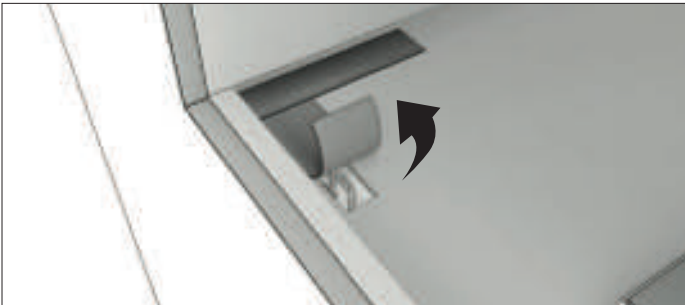

9. If your appliance includes a decorative box on the left / right or both, insert the internal glass panel by feeding the glass upwards into the slot then pushing down into the positioned clips.

**Decorative logs must NOT be placed directly over an open flame. They are designed to sit near heat but not over flames.*

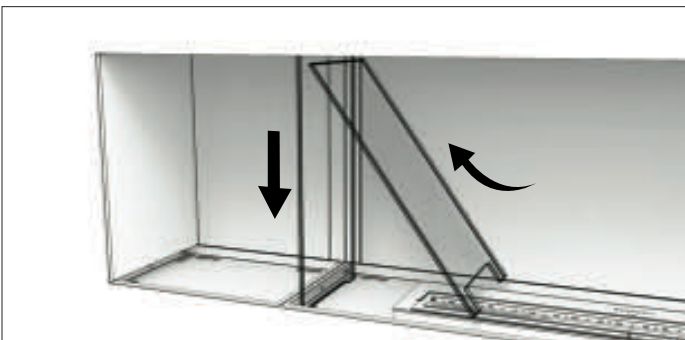

10. Insert the full height glass panel into one of the open end side by inserting the glass into the opening at the top of the appliance, and lowering it into the slots in the base until it bottoms out into place. Repeat the same for the other side of the appliance.

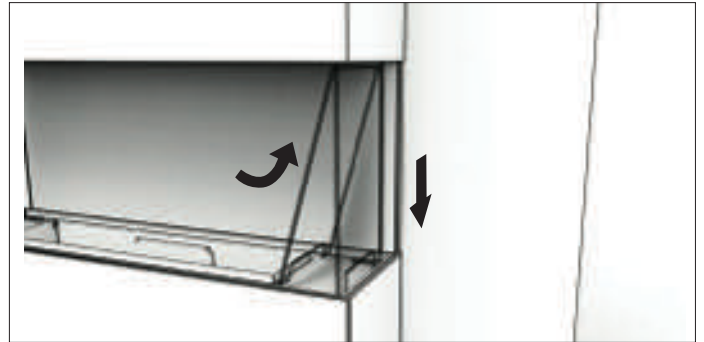

11. Install the windscreen by inserting the two ends into appropriate slots in the appliance. Use a small amount of pressure to push the windscreen in place until it bottoms out into the hidden glass clips.

WARNING: The glass used is toughened glass - which means it is stronger than normal glass. Importantly, even though it is stronger, toughened glass still has weaknesses. The corners and sides are specific pressure points where it is more fragile and can break if care is not taken. Glass breaks into many small pieces. Take care to avoid cuts. We recommend you wear protective gloves when handling glass.

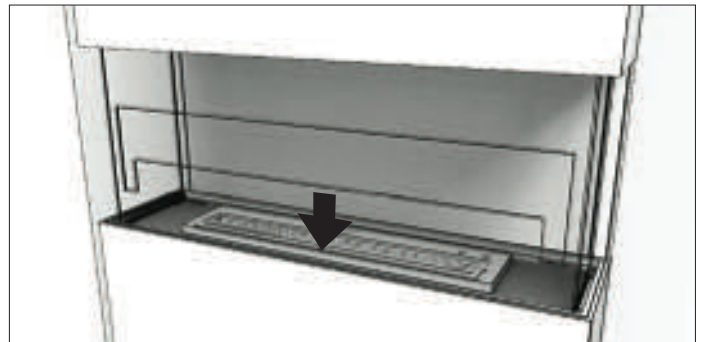

12. Spread the glass charcoal evenly around the appliance tray.
CAUTION: Make sure the burner lid is closed. Keep the glass charcoal away from the burner flange to avoid glass charcoal from accidentally going into the burner chamber. Be careful not to scratch the burner.

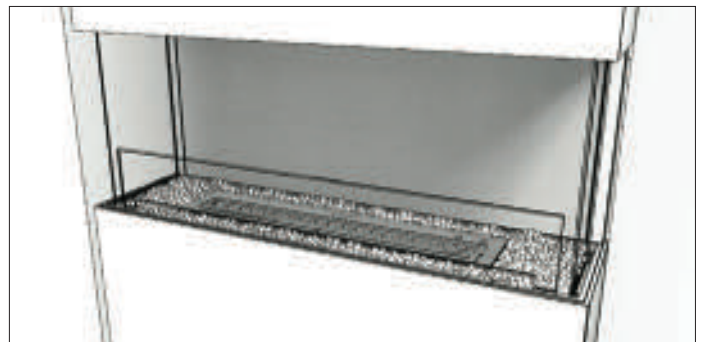

Double Sided Installation

Equipment required: Power Drill, Screwdriver, Level, Hand Trowel for Plaster, Silicone Gun, Caulk Gun

1. Construct a main wall framework with the opening size shown in Table D. The base of the frame can be a solid bench/platform, which will assist in leveling up the appliance when in position.

WARNING: Double-sided appliances cannot be inserted into a one-way cavity wall, it must be a two-way cavity where the glass on both sides is free from obstructions. Do not apply pressure or materials to the glass. Double sided appliances are designed as wall divider inserts. If you do not comply with this installation instruction the wall could overheat and catch fire.



Table D: Framework Opening Sizes

Physical appliance dimensions should be verified against cut out dimensions BEFORE installation begins to confirm tolerances align.

APPLIANCE	W mm [in]	D mm [in]	H mm [in]	Weight* kg [lbs]
FLEX18DB	488 [19.2]	349 [13.6]	730 [28.7]	26.5 [58.3]
FLEX32DB	922 [36.3]	349 [13.6]	730 [28.7]	46.6 [102.5]
FLEX42DB	1177 [46.3]	349 [13.6]	730 [28.7]	61.4 [135.1]
FLEX50DB	1380 [54.3]	349 [13.6]	730 [28.7]	70.8 [155.8]
FLEX50DB.BX	1380 [54.3]	349 [13.6]	730 [28.7]	70 [154]
FLEX60DB.BX	1634 [64.3]	349 [13.6]	730 [28.7]	83.3 [183.3]
FLEX68DB	1840 [72.4]	349 [13.6]	730 [28.7]	95.5 [210.1]
FLEX68DB.BX	1840 [72.4]	349 [13.6]	730 [28.7]	83.7 [184.1]
FLEX68DB.BX2	1840 [72.4]	349 [13.6]	730 [28.7]	94.8 [208.6]
FLEX78DB.BX2	2090 [82.3]	349 [13.6]	730 [28.7]	106.2 [233.6]
FLEX86DB	2300 [90.5]	349 [13.6]	730 [28.7]	102.3 [225.1]
FLEX86DB.BX	2300 [90.5]	349 [13.6]	730 [28.7]	124.5 [273.9]
FLEX86DB.BX2	2300 [90.5]	349 [13.6]	730 [28.7]	108.5 [238.7]
FLEX104DB	2760 [108.7]	349 [13.6]	730 [28.7]	145.7 [320.5]
FLEX104DB.BX	2760 [108.7]	349 [13.6]	730 [28.7]	127.1 [279.6]
FLEX104DB.BX2	2760 [108.7]	349 [13.6]	730 [28.7]	142 [312]
FLEX122DB	3220 [126.7]	349 [13.6]	730 [28.7]	145.6 [320.3]
FLEX122DB.BX	3220 [126.7]	349 [13.6]	730 [28.7]	170.1 [374.2]
FLEX122DB.BX2	3220 [126.7]	349 [13.6]	730 [28.7]	151.9 [334.2]
FLEX140DB.BX	3680 [144.9]	349 [13.6]	730 [28.7]	170.4 [374.9]
FLEX140DB.BX2	3680 [144.9]	349 [13.6]	730 [28.7]	192.9 [424.4]
FLEX158DB	4140 [163]	349 [13.6]	730 [28.7]	226.8 [499]
FLEX158DB.BX2	4140 [163]	349 [13.6]	730 [28.7]	195.2 [429.4]

* Appliance weight includes burner/s (dry weight excluding fuel), glass charcoal and glass. It does NOT include glass charcoal for side boxes.

IMPORTANT: The framing above the appliance must be self-supporting. The appliance is not load-bearing.

2. Remove the extension flange from the firebox so that both sides are the same height. This will help make sliding the firebox into the frame easier. Pay attention not to lose the screws, they will be needed again when the flange is re-installed.

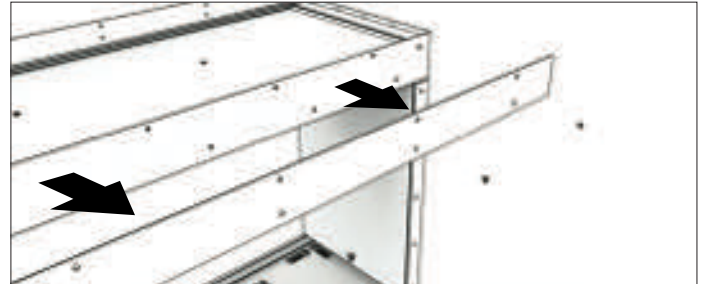

3. Slide the appliance inside the framing cavity (the bottom tray can sit directly on top of the frame). The appliance is shipped with red stability bracket(s) installed on the open side(s) to keep the appliance square while in transport and during installation. Keep the bracket(s) on while framing up the setting to assist in minimising movement of the appliance.

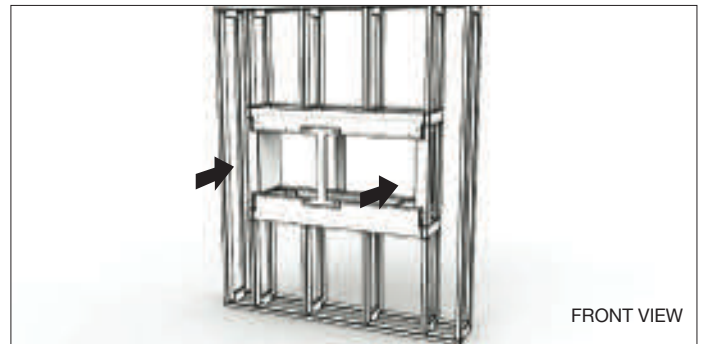

4. Align the flange extension panel with the threaded holes on the appliance. Screw it into place using the included screws (bottom row onto appliance, top row onto framing material) to secure it into position.



5. Fix the appliance to the framework with screws using the existing mounting holes on the appliance flanges. Make sure that the appliance is level before securing it in place.

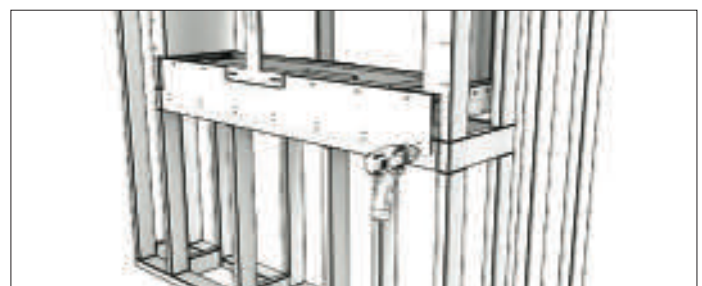

Double Sided Installation

6. Remove the red stability bracket(s).

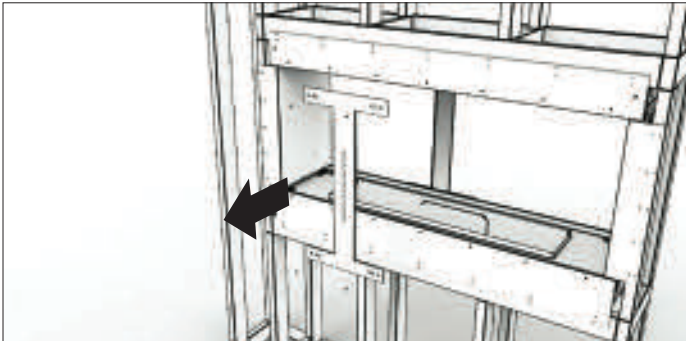

7. Complete the construction by finishing the wall paneling around the appliance. (See section on **FINISHING INSTRUCTIONS** and ensure that you fully understand where non combustible materials must be used.)



8. Place the burner into position.

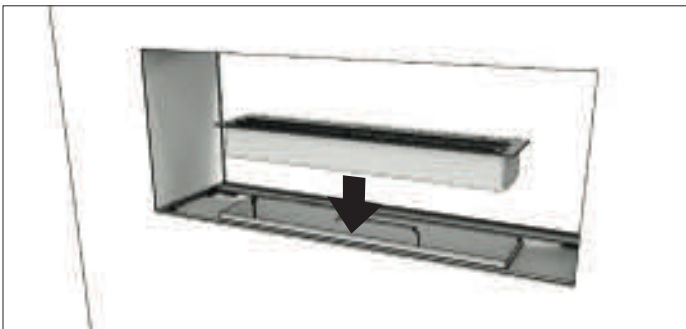

9. Remove the dust protective tape that covers the windscreen mounting slots.

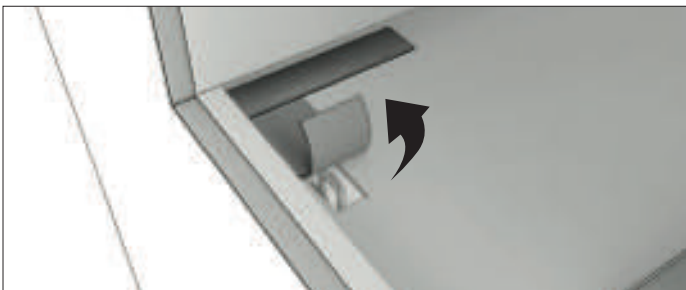

10. If your appliance includes a decorative box on the left / right or both, insert the internal glass panel by feeding the glass upwards into the slot then pushing down into the positioned clips.

**Decorative logs must NOT be placed directly over an open flame. They are designed to sit near heat but not over flames.*

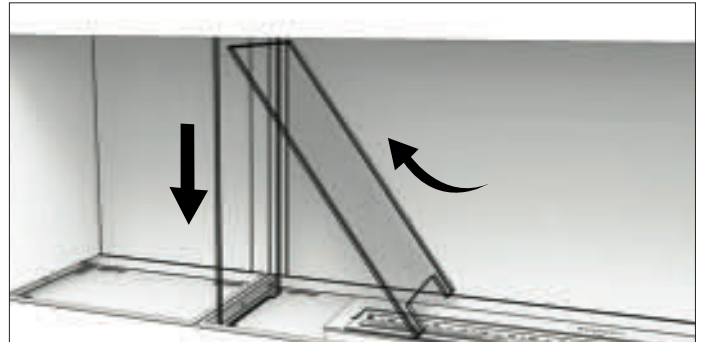

11. Install the windscreen by inserting the two ends into appropriate slots in the appliance. Use a small amount of pressure to push the windscreen in place until it bottoms out into the hidden glass clips. Repeat the same for the back side windscreen.

WARNING: The glass used is toughened glass - which means it is stronger than normal glass. Importantly, even though it is stronger, toughened glass still has weaknesses. The corners and sides are specific pressure points where it is more fragile and can break if care is not taken. Glass breaks into many small pieces. Take care to avoid cuts. We recommend you wear protective gloves when handling glass.



12. Spread the glass charcoal evenly around the appliance tray. **CAUTION:** Make sure the burner lid is closed. Keep the glass charcoal away from the burner flange to avoid glass charcoal from accidentally going into the burner chamber. Be careful not to scratch the burner.

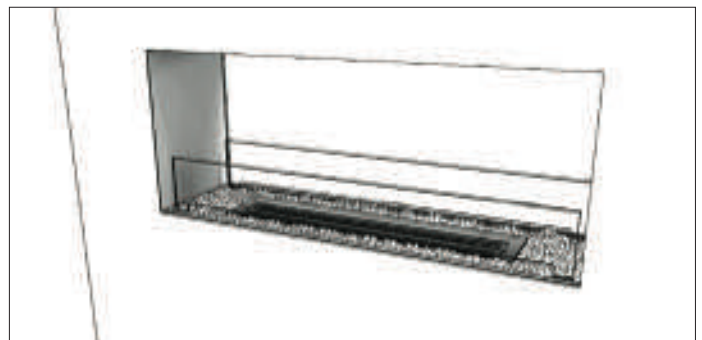

Peninsula Installation

Equipment required: Power Drill, Screwdriver, Level, Hand Trowel for Plaster, Silicone Gun, Caulk Gun

1. Construct a main wall framework with the opening size shown in Table E. The base of the frame can be a solid bench/platform, which will assist in leveling up the appliance when in position.

WARNING: Three-sided appliances cannot be inserted into a one-way cavity wall, it must be a two-way cavity where the glass on all sides are free from obstructions. Do not apply pressure or materials to the glass. Triple sided appliances are designed as room divider inserts. If you do not comply with this installation instruction the wall could overheat and catch fire.



Table E: Framework Opening Sizes

Physical appliance dimensions should be verified against cut out dimensions BEFORE installation begins to confirm tolerances align.

APPLIANCE	W mm [in]	D mm [in]	H mm [in]	Weight* kg [lbs]
FLEX18PN	470 [18.5]	349 [13.6]	730 [28.7]	34.2 [75.2]
FLEX32PN	902 [35.5]	349 [13.6]	730 [28.7]	49.8 [109.6]
FLEX42PN	1157 [45.5]	349 [13.6]	730 [28.7]	64.7 [142.3]
FLEX50PN	1362 [53.6]	349 [13.6]	730 [28.7]	59.1 [130]
FLEX50PN.BX	1362 [53.6]	349 [13.6]	730 [28.7]	73.2 [161]
FLEX60PN.BX	1617 [63.7]	349 [13.6]	730 [28.7]	87.5 [192.5]
FLEX68PN	1822 [71.7]	349 [13.6]	730 [28.7]	102.8 [226.2]
FLEX68PN.BX	1822 [71.7]	349 [13.6]	730 [28.7]	83.9 [184.6]
FLEX68PN.BX2	1822 [71.7]	349 [13.6]	730 [28.7]	96.1 [211.4]
FLEX78PN.BX2	2077 [81.8]	349 [13.6]	730 [28.7]	110.4 [242.9]
FLEX86PN	2282 [89.8]	349 [13.6]	730 [28.7]	102.5 [225.5]
FLEX86PN.BX	2282 [89.8]	349 [13.6]	730 [28.7]	124.1 [273]
FLEX86PN.BX2	2282 [89.8]	349 [13.6]	730 [28.7]	108.7 [239.1]
FLEX104PN	2742 [107.9]	349 [13.6]	730 [28.7]	153.3 [337.3]
FLEX104PN.BX	2742 [107.9]	349 [13.6]	730 [28.7]	127.3 [280.1]
FLEX104PN.BX2	2742 [107.9]	349 [13.6]	730 [28.7]	147.3 [324.1]
FLEX122PN	3202 [126.1]	349 [13.6]	730 [28.7]	145.8 [320.8]
FLEX122PN.BX	3202 [126.1]	349 [13.6]	730 [28.7]	176.2 [387.6]
FLEX122PN.BX2	3202 [126.1]	349 [13.6]	730 [28.7]	152.1 [334.6]
FLEX140PN.BX	3662 [144.2]	349 [13.6]	730 [28.7]	170.6 [375.3]
FLEX140PN.BX2	3662 [144.2]	349 [13.6]	730 [28.7]	198.7 [437.1]
FLEX158PN	4122 [162.3]	349 [13.6]	730 [28.7]	231.8 [510]
FLEX158PN.BX2	4122 [162.3]	349 [13.6]	730 [28.7]	195.4 [429.9]

* Appliance weight includes burner/s (dry weight excluding fuel), glass charcoal and glass. It does NOT include glass charcoal for side boxes.

IMPORTANT: The framing above the appliance must be self-supporting. The appliance is not load-bearing.

2. Remove the extension flange from the firebox so that both sides are the same height. This will help make sliding the firebox into the frame easier. Pay attention not to lose the screws, they will be needed again when the flange is re-installed.



3. Slide the appliance into the framing cavity (the bottom tray can sit directly on top of the frame). The appliance is shipped with red stability bracket(s) on the open sides to keep the appliance square while in transport and during installation. Keep these brackets on while framing up the setting to assist in minimizing movement of the appliance.

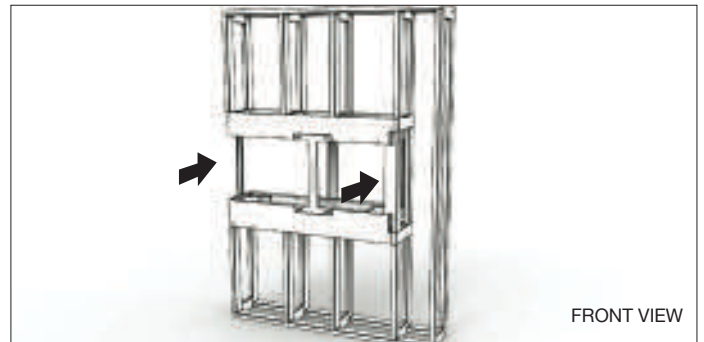

4. Ensure that the back and open side edge of the appliance are flush with frame studs.

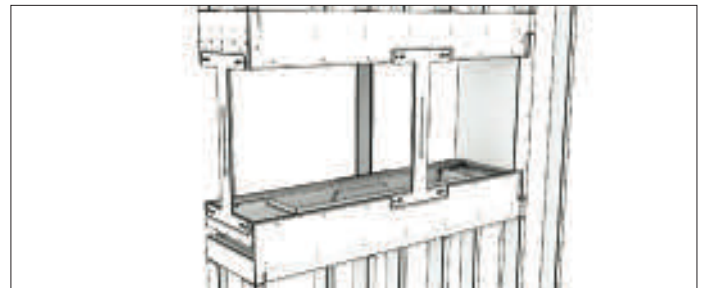

5. Align the flange extension panel with the threaded holes on the appliance. Screw it into place using the included screws (bottom row onto appliance, top row onto framing material) to secure it into position.



Peninsula Installation

6. Fix the appliance to the framework with screws using the existing mounting holes on the appliance flanges. Make sure that the appliance is level before securing it in place.

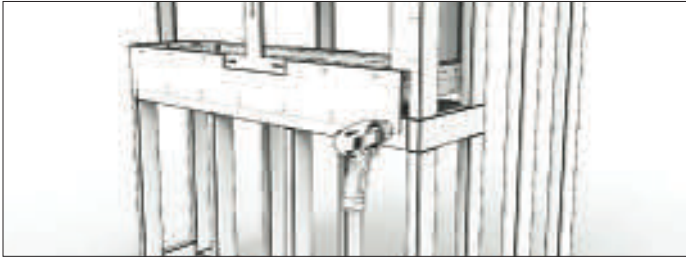

7. Remove the red stability brackets.

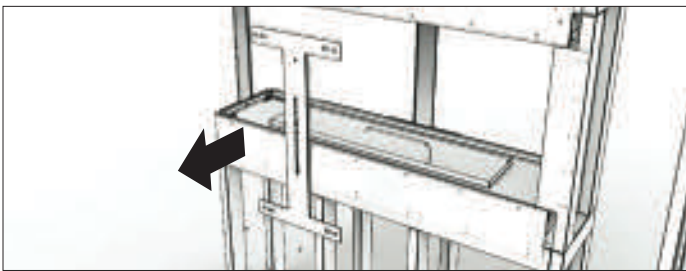

8. Complete the construction by finishing the wall paneling around the appliance. (See section on **FINISHING INSTRUCTIONS** and ensure that you fully understand where non combustible materials must be used.)



9. Place the burner into position.

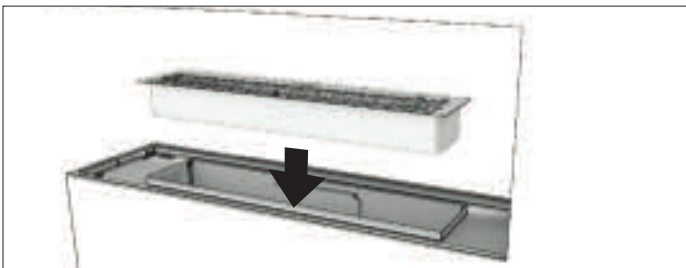

10. Remove the dust protective tape that covers the windscreen mounting slots.

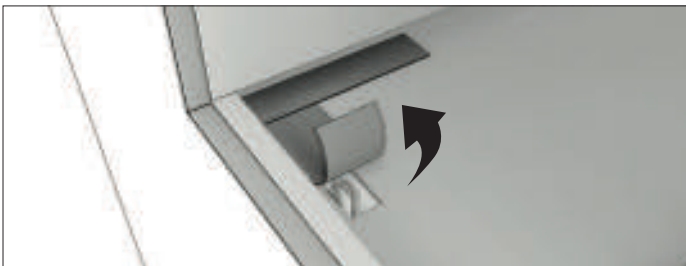

11. If your appliance includes a decorative box on the left / right or both, insert the internal glass panel by feeding the glass upwards into the slot then pushing down into the positioned clips.

**Decorative logs must NOT be placed directly over an open flame. They are designed to sit near heat but not over flames.*

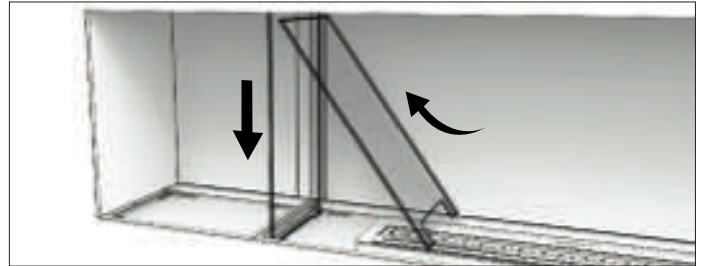

12. Insert the full height glass panel into the open end side by inserting the glass into the opening at the top of the appliance, and lowering it into the slots in the base until it bottoms out into place.

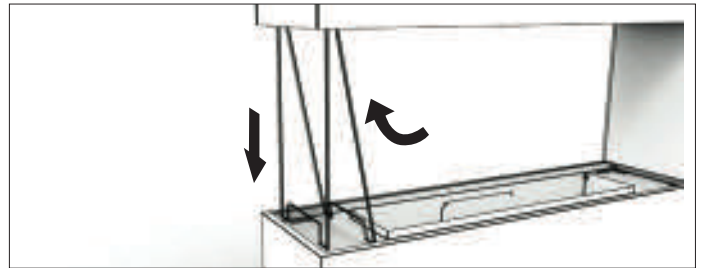

13. Install the windscreen by inserting the two ends into appropriate slots in the appliance. Use a small amount of pressure to push the windscreen in place until it bottoms out into the hidden glass clips. Repeat the same for the back side windscreen.

WARNING: The glass used is toughened glass - which means it is stronger than normal glass. Importantly, even though it is stronger, toughened glass still has weaknesses. The corners and sides are specific pressure points where it is more fragile and can break if care is not taken. Glass breaks into many small pieces. Take care to avoid cuts. We recommend you wear protective gloves when handling glass.

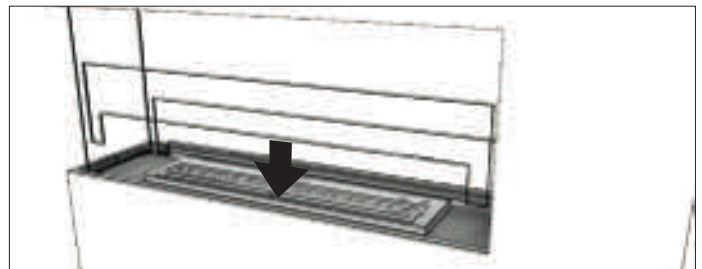

14. Spread the glass charcoal evenly around the appliance tray.
CAUTION: Make sure the burner lid is closed. Keep the glass charcoal away from the burner flange to avoid glass charcoal from accidentally going into the burner chamber. Be careful not to scratch the burner.

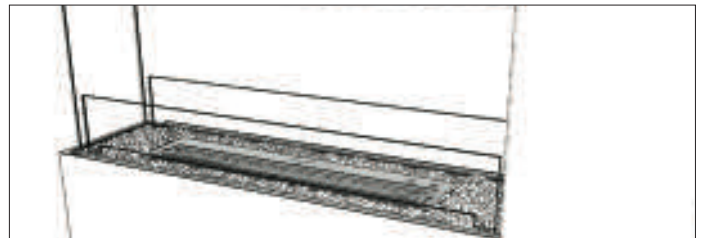

Island Installation

Equipment required: Power Drill, Screwdriver, Level, Hand Trowel for Plaster, Silicone Gun, Caulk Gun

1. Construct the framework with the opening size shown in Table F. The base of the frame can be a solid bench/platform, which will assist in leveling up the appliance when in position.

WARNING: This four-sided appliance cannot be inserted into a wall structure. It must be installed on a separate framework securely anchored to the floor. Do not install on moveable or weak structure. The top part of the appliance should be installed on framework secured to the ceiling and aligned with the bottom frame. Four-sided appliances are designed as wall divider inserts. If you do not comply with this installation instruction, the structure could overheat and catch fire.



Table F: Framework Opening Sizes

Physical appliance dimensions should be verified against cut out dimensions BEFORE installation begins to confirm tolerances align.

APPLIANCE	W mm [in]	D mm [in]	H mm [in]	Weight* kg [lbs]
FLEX18IL	455 [17.9]	349 [13.6]	730 [28.7]	22.2 [48.9]
FLEX32IL	887 [34.9]	349 [13.6]	730 [28.7]	33.5 [73.7]
FLEX42IL	1142 [45]	349 [13.6]	730 [28.7]	49.8 [109.6]
FLEX50IL	1347 [53]	349 [13.6]	730 [28.7]	59.9 [131.8]
FLEX50IL.BX	1347 [53]	349 [13.6]	730 [28.7]	48.3 [106.3]
FLEX60IL.BX	1602 [63.1]	349 [13.6]	730 [28.7]	64.6 [142.2]
FLEX68IL	1807 [71.1]	349 [13.6]	730 [28.7]	75.2 [165.5]
FLEX68IL.BX	1807 [71.1]	349 [13.6]	730 [28.7]	74.7 [164.4]
FLEX68IL.BX2	1807 [71.1]	349 [13.6]	730 [28.7]	63.1 [138.9]
FLEX78IL.BX2	2062 [81.2]	349 [13.6]	730 [28.7]	79.4 [174.8]
FLEX86IL	2267 [89.3]	349 [13.6]	730 [28.7]	101.5 [223.2]
FLEX86IL.BX	2267 [89.3]	349 [13.6]	730 [28.7]	90 [198.1]
FLEX86IL.BX2	2267 [89.3]	349 [13.6]	730 [28.7]	89.5 [197]
FLEX104IL	2727 [107.4]	349 [13.6]	730 [28.7]	116.3 [255.9]
FLEX104IL.BX	2727 [107.4]	349 [13.6]	730 [28.7]	116.3 [255.9]
FLEX104IL.BX2	2727 [107.4]	349 [13.6]	730 [28.7]	104.8 [230.6]
FLEX122IL	3187 [125.5]	349 [13.6]	730 [28.7]	148.6 [327]
FLEX122IL.BX	3187 [125.5]	349 [13.6]	730 [28.7]	131.1 [288.4]
FLEX122IL.BX2	3187 [125.5]	349 [13.6]	730 [28.7]	131.1 [288.4]
FLEX140IL.BX	3647 [143.6]	349 [13.6]	730 [28.7]	163.4 [359.6]
FLEX140IL.BX2	3647 [143.6]	349 [13.6]	730 [28.7]	145.9 [321.1]
FLEX158IL	4107 [161.7]	349 [13.6]	730 [28.7]	173.9 [382.6]
FLEX158IL.BX2	4107 [161.7]	349 [13.6]	730 [28.7]	178.3 [392.2]

* Appliance weight includes burner/s (dry weight excluding fuel), glass charcoal and glass. It does NOT include glass charcoal for side boxes.

IMPORTANT: The framing above the appliance must be self-supporting. The appliance is not load-bearing.

2. Remove the extension flange from the firebox so that both sides are the same height. This will help make sliding the firebox into the frame easier. Pay attention not to lose the screws, they will be needed again when the flange is re-installed.

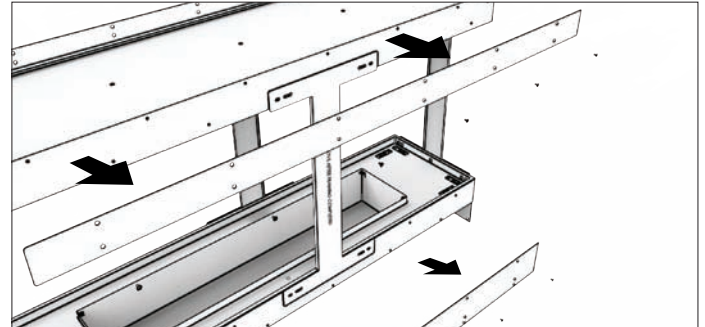

3. Slide the appliance inside the framing cavity (the bottom tray can sit directly on top of the frame). The appliance is shipped with red stability bracket(s) installed on the open side(s) to keep the appliance square while in transport and during installation. Keep the bracket(s) on while framing up the setting to assist in minimising movement of the appliance.

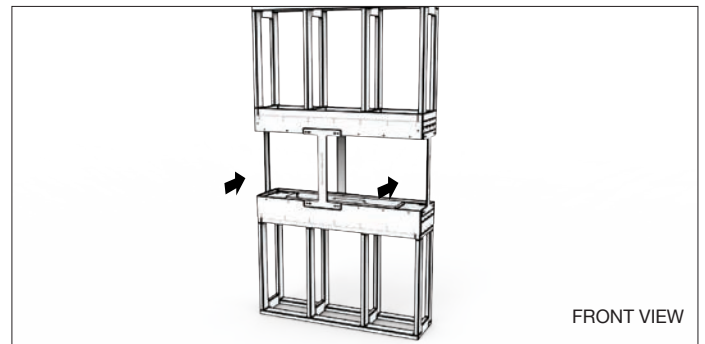

4. Align the flange extension panel with the threaded holes on the appliance. Screw it into place using the included screws (bottom row onto appliance, top row onto framing material) to secure it into position.

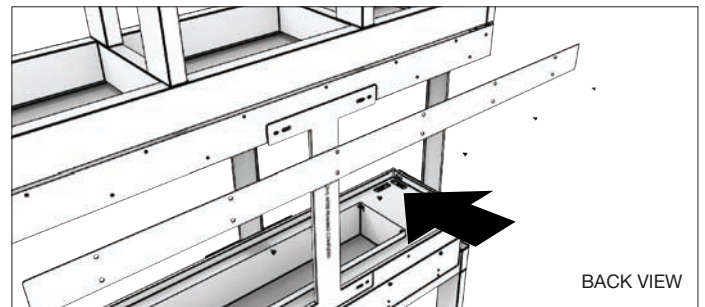

5. Fix the appliance to the framework with screws using the existing mounting holes on the appliance flanges. Make sure that the appliance is level before securing it in place.

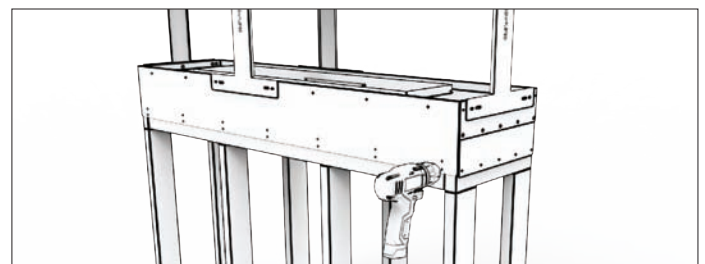

Island Installation

6. Remove the red stability bracket(s).

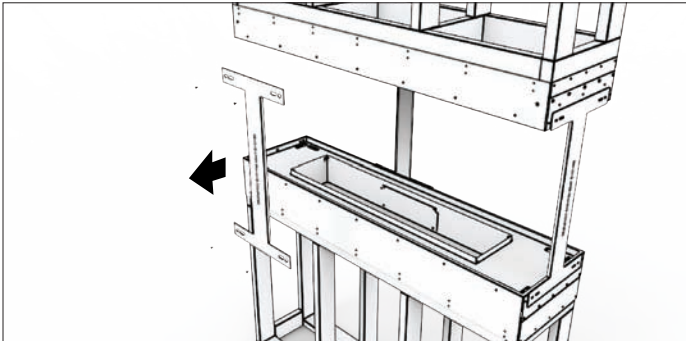

7. Complete the construction by finishing the wall paneling around the appliance. (See section on **FINISHING INSTRUCTIONS** and ensure that you fully understand where non combustible materials must be used.)

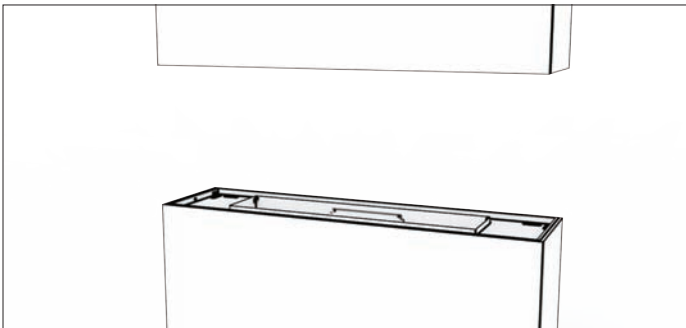

8. Place the burner into position.

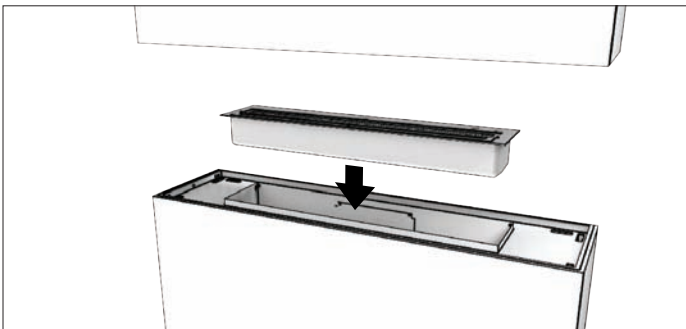

9. Remove the dust protective tape that covers the windscreen mounting slots.

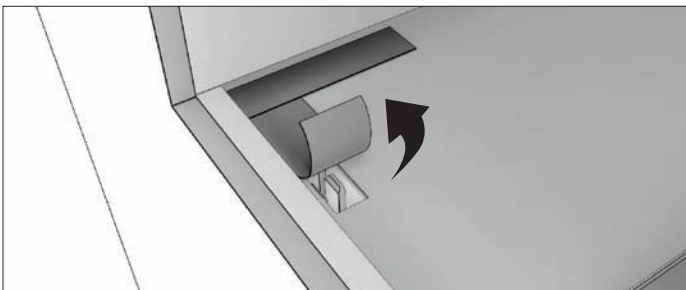

10. Install the windscreen by inserting the two ends into appropriate slots in the appliance. Use a small amount of pressure to push the windscreen in place until it bottoms out into the hidden glass clips. Repeat the same for the back side windscreen and if your appliance includes a decorative box on the left / right or both.

**Decorative logs must NOT be placed directly over an open flame. They are designed to sit near heat but not over flames. Add only one set of decorative logs to this model style.*

WARNING: The glass used is toughened glass - which means it is stronger than normal glass. Importantly, even though it is stronger, toughened glass still has weaknesses. The corners and sides are specific pressure points where it is more fragile and can break if care is not taken. Glass breaks into many small pieces. Take care to avoid cuts. We recommend you wear protective gloves when handling glass.

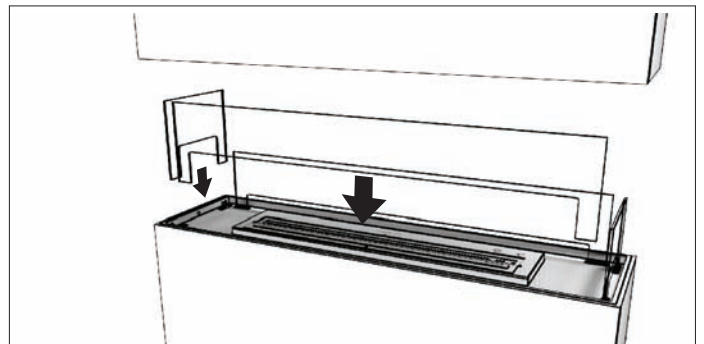

11. Spread the glass charcoal evenly around the appliance tray.

CAUTION: Make sure the burner lid is closed. Keep the glass charcoal away from the burner flange to avoid glass charcoal from accidentally going into the burner chamber. Be careful not to scratch the burner.

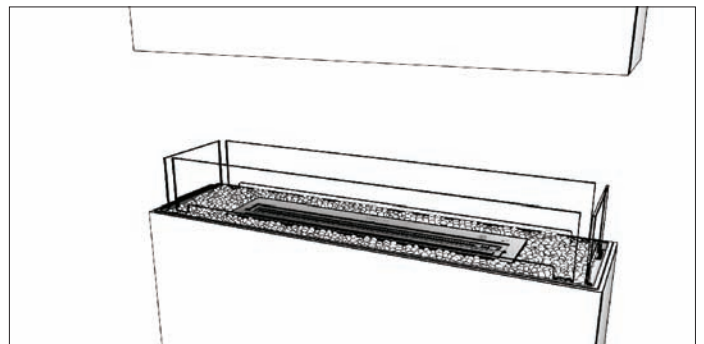

Bench Installation

Equipment required: Power Drill, Screwdriver, Level, Hand Trowel for Plaster, Silicone Gun, Caulk Gun

1. Construct the main framework using the dimensions shown on Table G. The base of the frame can be a solid bench/platform, which will assist in leveling up the appliance when in position. When planning construction, ensure that there is a minimum of 1500mm (59.1") overhead clearance from the burner opening to the ceiling.

WARNING: This four-sided appliance cannot be inserted into a wall structure. It must be installed on a separate framework securely anchored to the floor. Do not install on moveable or weak structure. Four-sided appliances are designed as wall divider inserts. If you do not comply with this installation instruction, the structure could overheat and catch fire.

2. Remove the extension flange from the firebox so that both sides are the same height. This will help make sliding the firebox into the frame easier. Pay attention not to lose the screws, they will be needed again when the flange is re-installed.

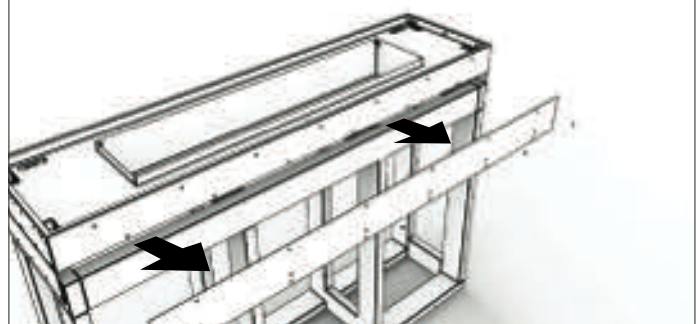

3. Slide the appliance inside the framing cavity (the bottom tray can sit directly on top of the frame).

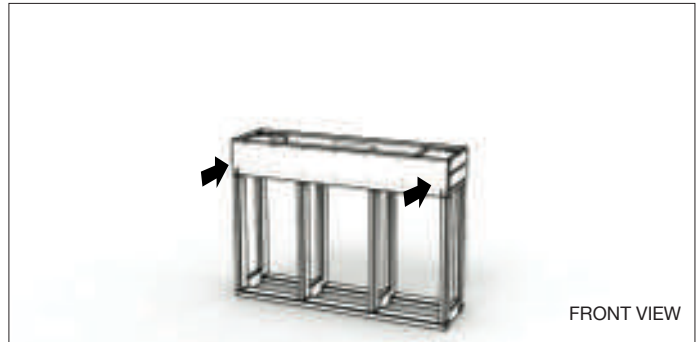
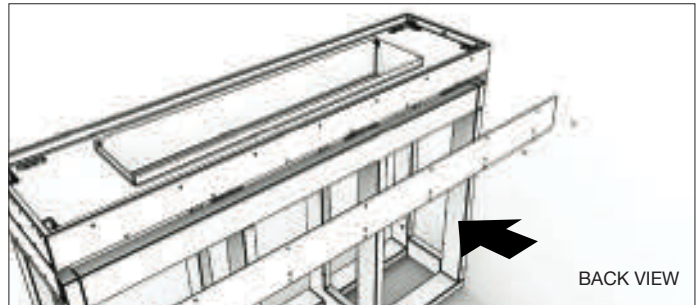

Table G: Framework Sizes

Physical appliance dimensions should be verified against cut out dimensions BEFORE installation begins to confirm tolerances align.

APPLIANCE	W mm [in]	D mm [in]	Weight* kg [lbs]
FLEX18BN	455 [17.9]	349 [13.6]	18.3 [40.2]
FLEX32BN	887 [34.9]	349 [13.6]	27.5 [60.6]
FLEX42BN	1142 [45]	349 [13.6]	33.8 [74.4]
FLEX50BN	1347 [53]	349 [13.6]	39.5 [86.9]
FLEX50BN.BX	1347 [53]	349 [13.6]	38.4 [84.5]
FLEX60BN.BX	1602 [63.1]	349 [13.6]	44.7 [98.4]
FLEX68BN	1807 [71.1]	349 [13.6]	50.3 [110.6]
FLEX68BN.BX	1807 [71.1]	349 [13.6]	61.1 [134.5]
FLEX68BN.BX2	1807 [71.1]	349 [13.6]	49.3 [108.5]
FLEX78BN.BX2	2062 [81.2]	349 [13.6]	55.6 [122.4]
FLEX86BN	2267 [89.3]	349 [13.6]	71.6 [157.5]
FLEX86BN.BX	2267 [89.3]	349 [13.6]	61.1 [134.5]
FLEX86BN.BX2	2267 [89.3]	349 [13.6]	61.3 [134.8]
FLEX104BN	2727 [107.4]	349 [13.6]	80 [176]
FLEX104BN.BX	2727 [107.4]	349 [13.6]	82.5 [181.5]
FLEX104BN.BX2	2727 [107.4]	349 [13.6]	72 [158.5]
FLEX122BN	3187 [125.5]	349 [13.6]	105.6 [232.4]
FLEX122BN.BX	3187 [125.5]	349 [13.6]	90.9 [200]
FLEX122BN.BX2	3187 [125.5]	349 [13.6]	93.4 [205.5]
FLEX140BN.BX	3647 [143.6]	349 [13.6]	116.5 [256.3]
FLEX140BN.BX2	3647 [143.6]	349 [13.6]	101.8 [224]
FLEX158BN	4107 [161.7]	349 [13.6]	118.8 [261.4]
FLEX158BN.BX2	4107 [161.7]	349 [13.6]	127.4 [280.3]

4. Align the flange extension panel with the threaded holes on the appliance. Screw it into place using the included screws (bottom row onto appliance, top row onto framing material) to secure it into position.



5. Fix the appliance to the framework with screws using the existing mounting holes on the appliance flanges. Make sure that the appliance is level before securing it in place.



* Appliance weight includes burner/s (dry weight excluding fuel), glass charcoal and glass. It does NOT include glass charcoal for side boxes.

Bench Installation

6. Complete the construction by finishing the wall paneling around the appliance. (See section on **FINISHING INSTRUCTIONS** and ensure that you fully understand where non combustible materials must be used.)



7. Place the burner into position.

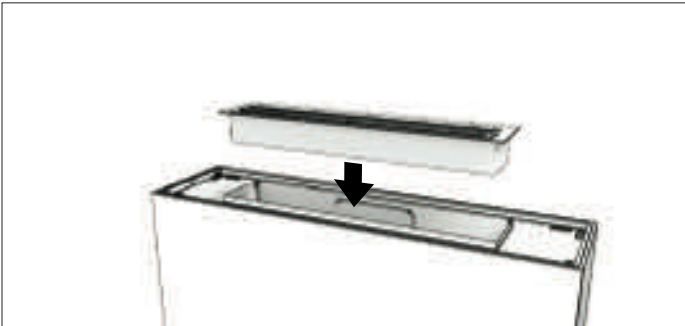

8. Remove the dust protective tape that covers the windscreen mounting slots.

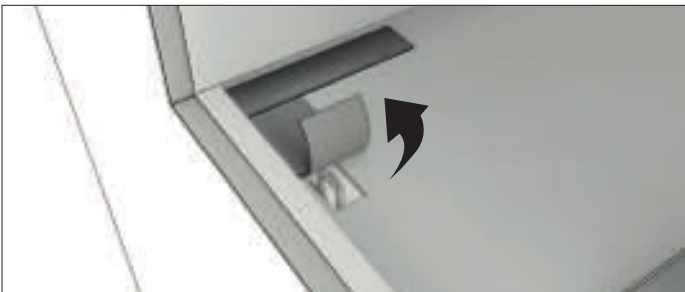

9. Install the windscreen by inserting the two ends into appropriate slots in the appliance. Use a small amount of pressure to push the windscreen in place until it bottoms out into the hidden glass clips. Repeat the same for the back side windscreen and if your appliance includes a decorative box on the left / right or both.

**Decorative logs must NOT be placed directly over an open flame. They are designed to sit near heat but not over flames. Add only one set of decorative logs to this model style.*

WARNING: The glass used is toughened glass - which means it is stronger than normal glass. Importantly, even though it is stronger, toughened glass still has weaknesses. The corners and sides are specific pressure points where it is more fragile and can break if care is not taken. Glass breaks into many small pieces. Take care to avoid cuts. We recommend you wear protective gloves when handling glass.

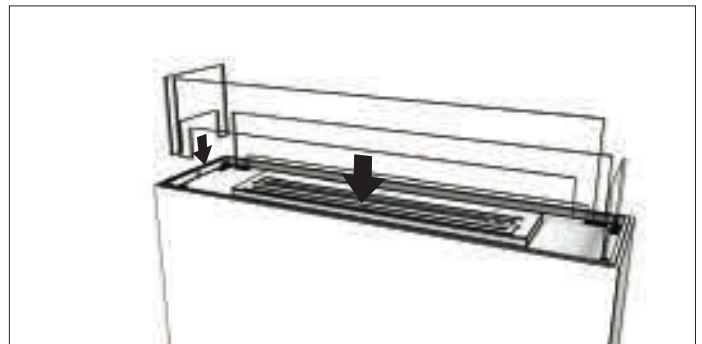

10. Spread the glass charcoal evenly around the appliance tray.
CAUTION: Make sure the burner lid is closed. Keep the glass charcoal away from the burner flange to avoid glass charcoal from accidentally going into the burner chamber. Be careful not to scratch the burner.

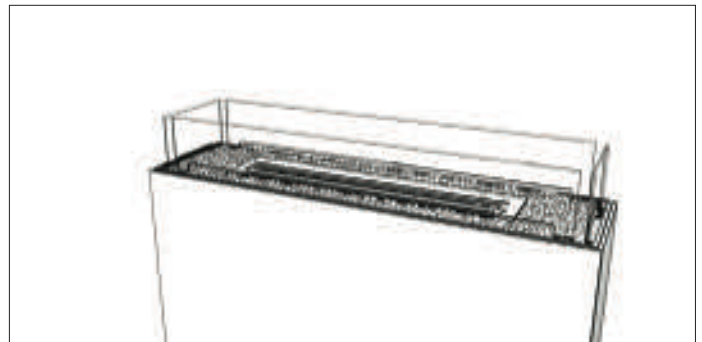

1. Apply surrounding wall panels. Acceptable materials include fibre cement board, fire-rated medium density fibreboard (FR MDF), stone, tiles, steel, and fire-rated (FR) plasterboard.

Facing or finishing materials must never overhang into the appliance opening.

WARNING! Risk of Fire! Do not apply combustible materials beyond the minimum clearances. Comply with all minimum clearances to combustibles as specified in this manual and the burner manual.

IMPORTANT: A 155mm [6"] non combustible panel must be installed above all sides of the appliance openings. See examples below.

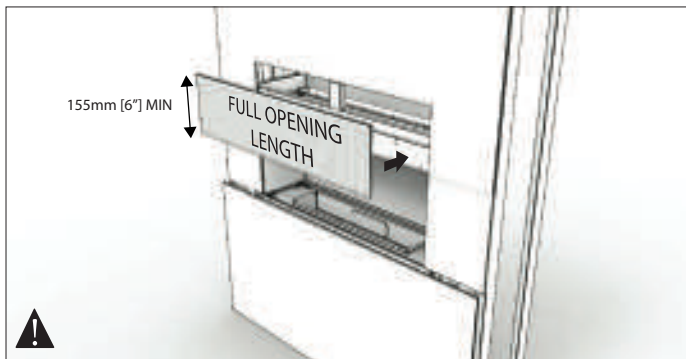

Example: Single Sided Fireplace

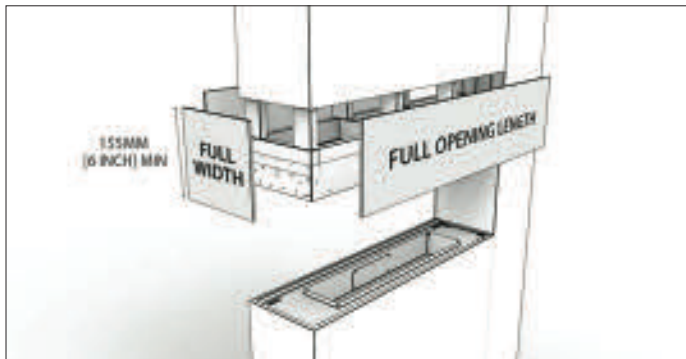

Example: Peninsula Fireplace

2. A metal trim bead MUST be installed on all edges (mitre the corners). (Do not use long fasteners thicker than the wall paneling material to avoid penetrating the appliance).

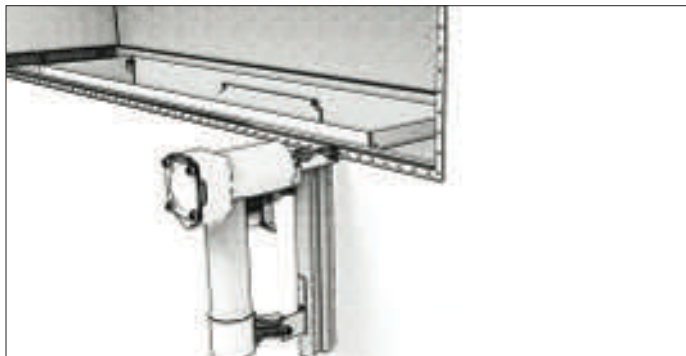

3. Plaster all seams and beads.

All joints between the finished wall sheathing and the front of the appliance must be sealed with non-combustible materials. Sealants, such as caulk or mastic used to seal the gap between the wall and the appliance, should be rated at a minimum continuous exposure to 150°C (122°F).

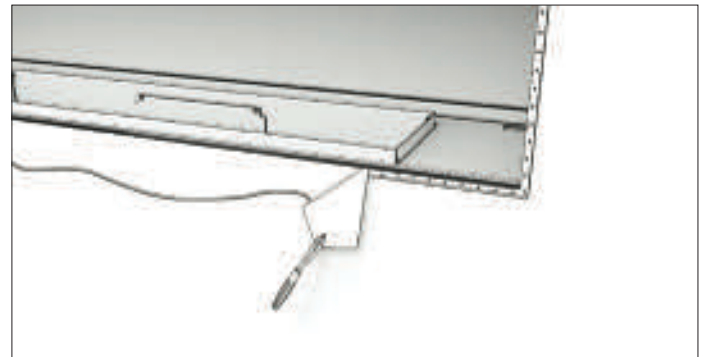

4. If desired finishing includes a painted wall, 100% acrylic latex or oil-based or standard acrylics may be used. Follow paint manufacturer's instructions for paint and primer application.

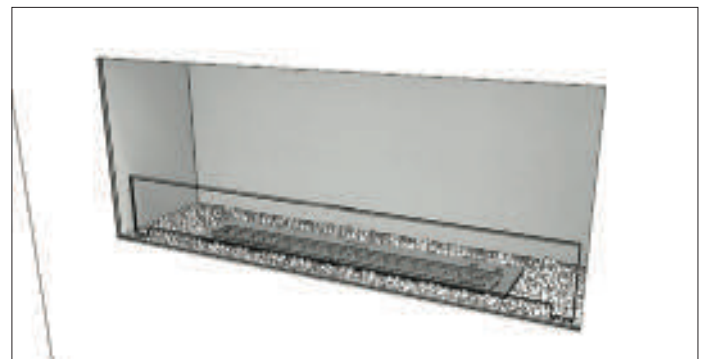

OPERATE ACCORDING TO THE BURNER OPERATIONS MANUAL INCLUDED WITH THE BURNER.

Mantel Surrounds

Minimum Clearances

If the setting incorporates a mantel the minimum vertical and maximum horizontal dimensions to combustible mantel identified in the image below must be followed.

Finishing clearances to COMBUSTIBLES

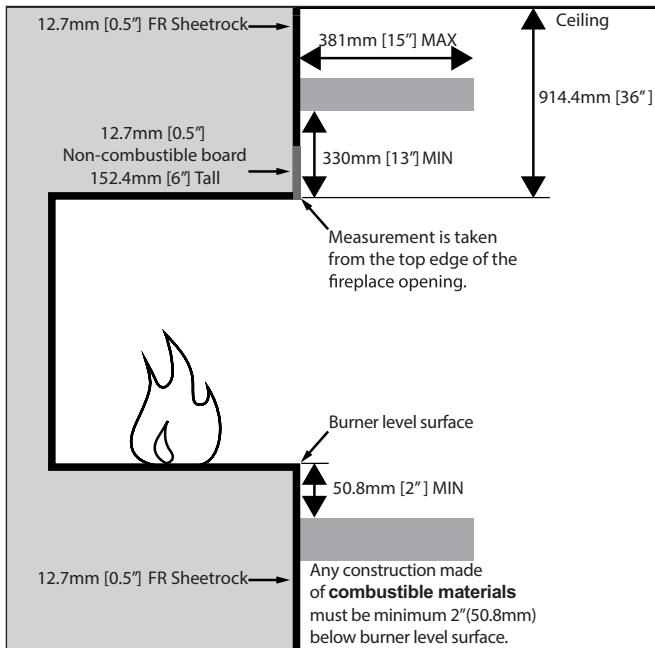

Minimum vertical and maximum horizontal dimensions of combustible mantel.

Finishing and clearances to NON-COMBUSTIBLES

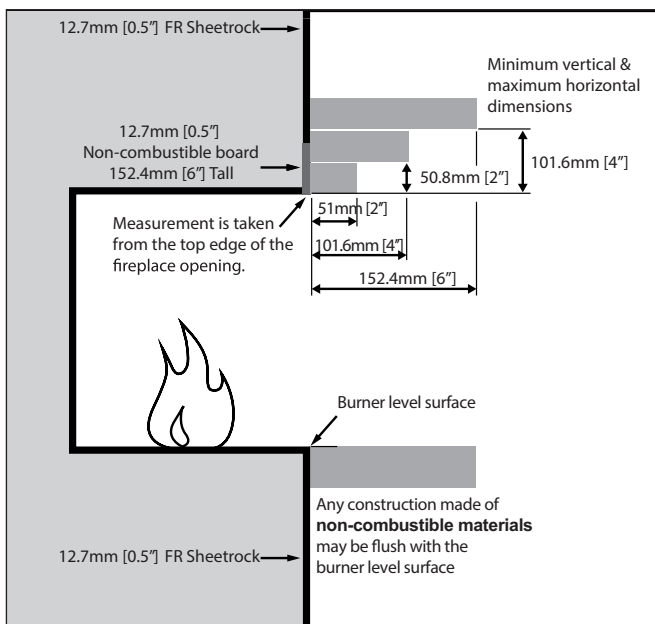

Minimum vertical and maximum horizontal dimensions of non-combustible mantel.

Warning! Risk of Fire! Comply with all minimum clearances to combustibles as specified. Framing or finishing material closer than the minimum listed must be constructed entirely of non-combustible materials.

Decorative Box Infill Plate

For appliances with a decorative side box, an infill plate is provided to lift the material to align with the bottom edge of the appliance. Decorative boxes must only be used to hold non-combustible accessories/materials.

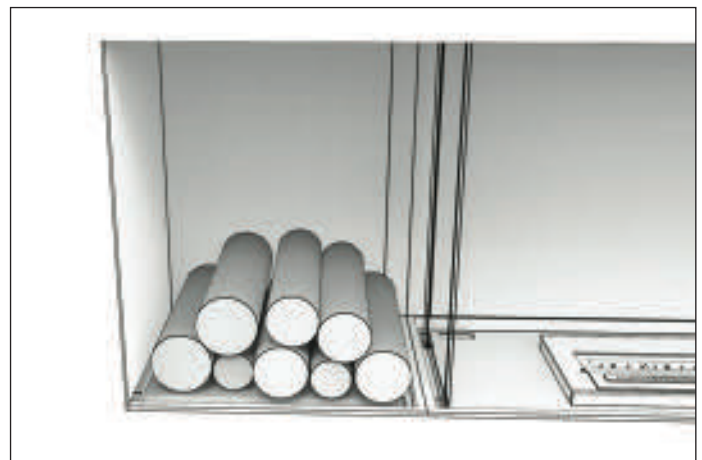
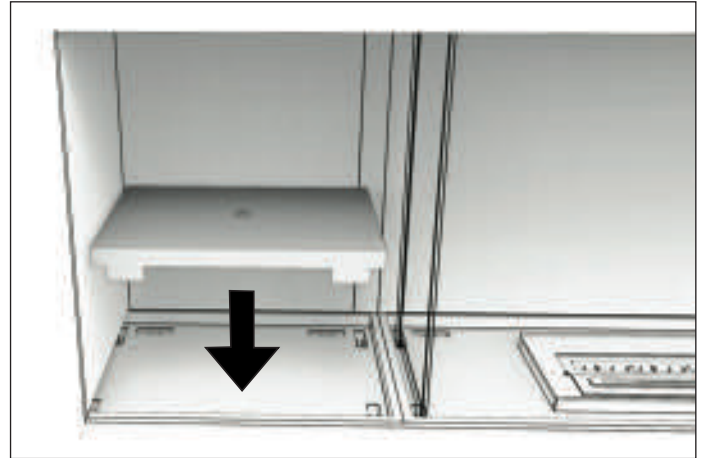

Decorative Steel Logs are available as an optional accessory. Please contact customerservice@ecosmartfire.com

**Decorative logs must NOT be placed directly over an open flame. They are designed to sit near heat but not over flames.*

Abstände zur Feuerstelle

AUSWAHL DES INSTALLATIONSORTES	22
BELÜFTUNG	22
MINDESTRAUMGRÖSSE	22

INSTALLATIONSANLEITUNG

EINBAURAHMEN	23
BEVOR DER INSTALLATION	24
EINSEITIG GEÖFFNETE INSTALLATION	25 - 26
LINKSSEITIG GEÖFFNETE INSTALLATION	27 - 28
RECHTSSEITIG GEÖFFNETE INSTALLATION	27 - 28
BAY INSTALLATION	29 - 30
BEIDSEITIG GEÖFFNETE INSTALLATION	31 - 32
PENINSULA INSTALLATION	33 - 34
ISLAND INSTALLATION	35 - 36
BENCH INSTALLATION	37 - 38
EINBAUANWEISUNG	39
KAMINSIMS	40
DEKORATIVE FÜLLPLATTE	40

Diese Geräte sind vom Hersteller nur für den Gebrauch mit den beiliegenden UL-gelisteten Brennern zugelassen.

INBETRIEBNAHME

Bitte lesen Sie die Bedienungsanleitung, die Sie mit Ihrem Brenner erhalten haben.

Abstände zur Feuerstelle

Bitte lesen Sie diese Anweisungen vor der Inbetriebnahme des EcoSmart™ Fire vollständig durch.

AUSWAHL DES INSTALLATIONSORTES

Die FLEX Feuerstellen verfügen über die erforderlichen Sicherheitsabstände zu bereits eingebauten brennbaren Rahmenkomponenten. Sie sind speziell für die Aufnahme kompatibler EcoSmart Fire Brenner ausgelegt.

Bei der Auswahl eines Aufstellungsortes für das Gerät ist es wichtig, die erforderlichen Mindestraumgrößen und -abstände zu Wänden und brennbaren Materialien zu berücksichtigen (siehe Abbildungen der Abstände und Mindestraumgröße).

Hinweis: Flex-Feuerstellen werden aus mit Zink versiegeltem Stahl hergestellt, der mit einer hitzebeständigen schwarzen Farbe pulverlackiert ist, um Rostbildung zu verhindern. Die Brenner bestehen aus 304 Edelstahl. Um sicherzustellen, dass der Brenner weiterhin gut aussieht und Rost oder Korrosion vermieden wird, ist es wichtig, dass Verunreinigungen oder Verschmutzungen sofort vom Brenner entfernt werden.

Bei Aufstellung im Freien muss sich das Gerät unter einer Überdachung befinden, damit es nicht mit Wasser gefüllt wird und dauerhaft beschädigt wird. Die Garantie erlischt, wenn das Produkt durch Installation an einem exponierten Ort beschädigt wird.

Halten Sie den Brennerdeckel bei Nichtgebrauch geschlossen, um zu verhindern, dass Schmutz in die Brennerkammer fällt und Verunreinigung verursacht.

WARNUNG: Brand- oder Verbrennungsgefahr! Sorgen Sie für ausreichenden Freiraum um die Luftöffnungen und für den Wartungszugang. Beachten Sie die in dieser Anleitung und im Brennerhandbuch empfohlenen Abstände zu brennbaren Stoffen. Stellen Sie sicher, dass Ihr Feuer immer von brennbaren Materialien und anderen Zündquellen ferngehalten wird. Aufgrund der hohen Temperaturen sollte das Gerät außerhalb von Laufwegen und von Möbeln und Vorhängen aufgestellt werden. Achten Sie besonders darauf, das Feuer von Gegenständen fernzuhalten, die sich durch Wind und Zug bewegen können. Zum Beispiel Bäume / Äste / Vorhänge / Papier und dergleichen. Halten Sie Kinder stets in sicherem Abstand und lassen Sie sie niemals unbeaufsichtigt, wenn das Gerät eingeschaltet oder heiß ist.

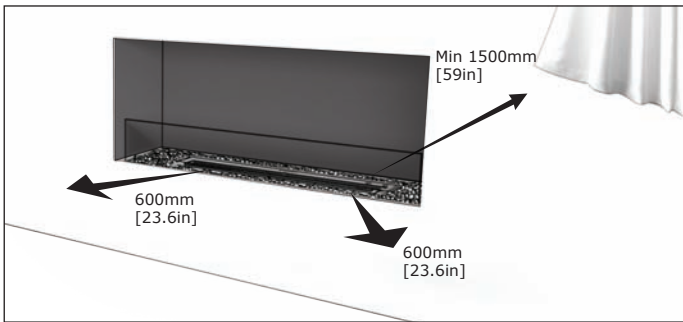

Sicherheitsabstände im Innenbereich

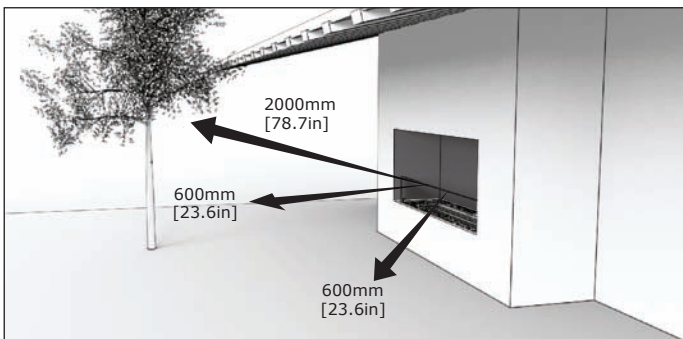

Sicherheitsabstände im Freien (Überhang oder "Dachausdehnung" über dem Kamin ist erforderlich, damit kein Regen in die Feuerstelle gelangt. Erkundigen Sie sich über die örtlichen Bauvorschriften bezüglich der Anforderungen für Überhänge / Dachausdehnungen.

BELÜFTUNG

Bei EcoSmart Fires ist keine dauerhafte Befestigung oder spezielles Zubehör erforderlich, z. B. ein Schornstein für die Belüftung, oder eine dauerhafte Verbindung für die Brennstoffversorgung.

Decken Sie keine vorhandenen Lüftungssysteme oder -strukturen ab, die innerhalb des ausgewählten Installationsbereichs verbaut oder installiert wurden.

Um eine ausreichende Belüftung sicherzustellen, beachten Sie die Richtlinien in der beiliegenden Tabelle.

Underwriters Laboratories (UL) berechnet einen angemessenen Luftaustausch wie folgt:

In einem typischen Haus, das heißt einem Haus, das aufgrund seiner starken Isolierung und der dichten Abdichtung gegen das Eindringen von Luft nicht ungewöhnlich dicht ist, wird durch das Eindringen von Luft eine ausreichende Luftzufuhr für die Verbrennung und Belüftung gewährleistet. Wenn der Brenner jedoch in einem kleinen Raum verwendet wird, in dem pro 1000 BTU pro Stunde der Geräteleistung (unter Berücksichtigung der maximalen Brenneinstellung) weniger als 5,7 m³ [200 ft³] Luftraum zur Verfügung stehen, sollten die Türen zum angrenzenden Räumen offen gehalten werden oder ein Fenster nach außen sollte mindestens 25,4 mm [1 Zoll] geöffnet werden, um eine mögliche Ansammlung von Luftverschmutzung in Innenräumen zu verhindern. Nicht in einem Badezimmer oder einem anderen kleinen Raum installieren oder betreiben.

MINDESTRAUMGRÖSSE

Belüftungstabelle nach Anzahl der Brenner (pro Gerät).

Model	Brenner	Mindestgröße des Zimmers	BTU
FLEX18	1x AB3	1413 Kubikfuß (40 Kubikmeter)	5,800
FLEX32 FLEX50.BX FLEX68.BX2	1x XL500	2825 Kubikfuß (80 Kubikmeter)	11,430
FLEX42 FLEX60.BX FLEX78.BX2	1x XL700	3178 Kubikfuß (90 Kubikmeter)	13,650
FLEX50 FLEX68.BX FLEX86.BX2	1x XL900	3884 Kubikfuß (110 Kubikmeter)	15,000
FLEX68 FLEX86.BX FLEX104.BX2	1x XL1200	4061 Kubikfuß (115 Kubikmeter)	16,200
FLEX86 FLEX104.BX FLEX122.BX2	2x XL900	7768 Kubikfuß (220 Kubikmeter)	30,000
FLEX104 FLEX122.BX FLEX140.BX2	2x XL1200	8122 Kubikfuß (230 Kubikmeter)	32,400
FLEX122 FLEX140.BX FLEX158.BX2	3x XL900	11652 Kubikfuß (330.2 Kubikmeter)	45,000
FLEX158	3x XL1200	12183 Kubikfuß (345 Kubikmeter)	48,600

NICHT FÜR DEN GEBRAUCH ALS PRIMÄRE WÄRMEQUELLE VORGESEHEN

Dieses Gerät ist als zusätzliche Wärmequelle oder als dekorative Gerät getestet und zugelassen. Es sollte nicht als Primäre Wärmequelle bei der Berechnung der Wohnheizung berücksichtigt werden.

Diese Geräte müssen vor Inbetriebnahme in einer sicheren Position fest installiert werden.

HINWEIS: NICHT DIREKT ZWISCHEN ODER IN DER NÄHE VON TAPETEN, LAMINATEN, FURNIEREN ODER JEDLICHER OBERFLÄCHE, DIE NICHT FÜR WÄRME- UND HOHE TEMPERATUREN AUSGELEGT IST, INSTALLATIEREN (die Hitze wirkt sich auf das Material und unter Umständen auf den Klebstoff aus). DIE UMGEBUNG UM DAS GERÄT WIRD HEISS. WÄRMEEMPFLINDLICHE / REAKTIVE MATERIALIEN SOLLTEN NICHT VERWENDET WERDEN. KEINE ENTFLAMMBAREN OBJEKTE AUF DAS GERÄT ODER UM DAS GERÄT PLATZIEREN.

Diese Geräte sind nicht dazu ausgelegt, hinter Türen oder Abdeckungen verbaut zu werden.

Das Gerät muss jederzeit ausreichend belüftet sein - es ist nicht für den Betrieb als Ofen oder eine ähnliche "Hot Box" konzipiert. Die Flamme muss ständig mit Luft versorgt werden, um die Wärme effektiv und verteilen zu können

FÜLLEN SIE NICHT DIE ERFORDERLICHEN LUFTRÄUME (den Raum zwischen dem Gerät und dem Abstandhalter) MIT ISOLIERUNG ODER ANDEREN MATERIALIEN. Die Abstände sind erforderlich, um sicherzustellen, dass erforderlichen Temperaturen hinter der Firebox erhalten bleiben.

Modifizieren sie die Feuerstelle während der Installation auf keine Weise. Das Abschneiden von Metalteilen der Firebox ist verboten.

Das Ausdehnen und Zusammenziehen der Innenteile durch Erwärmen und Abkühlen kann Geräusche verursachen. Das ist normal.

ACHTUNG: NIEMALS OHNE GLAS-WINDSCHUTZ/WINDSCREEN ENTZÜNDEN!

Die Firebox muss sicher und vollständig verbaut sein, bevor diese in Betrieb genommen werden darf. Ein fehlerhaft installierter(oder komplett entfernter) Glas-Windschutz/Windscreen setzt die Garantie außer Kraft. Der Gebrauch des mitgelieferten Brenners ist nur in Verbindung mit der Firebox UND dem Glas- Windschutz/Windscreen zugelassen

EINBAU

Wichtige Information zum Einbau

1. Die Firebox muss auf einer ebenen Fläche aufgestellt werden, auf der die Firebox, der Brenner, Glas und die volle Brennstoffkapazität untergebracht werden können.
2. Die in den Anweisungen angegebenen Abmessungen der Rahmen sind die optimalen Abmessungen, die eine optimale Anpassung an Gipskartonplatten (oder anderes Verkleidungsmaterial) nach der Installation des Geräts ermöglichen.
3. Wenn Sie das Gerät auf eine Plattform stellen, bauen Sie die Plattform auf, und stellen Sie sicher, dass das Gewicht des Geräts, des Brenners, des Glases und des Brennstoffs berücksichtigt werden. Stellen Sie sicher, dass die Plattform eben ist.

Bei unzureichender Tragkraft des Rahmens muss dieser ausreichend verstärkt werden (z. B. durch die Installation einer Platte zur Lastverteilung), um das gesamte Gewicht der Firebox zu tragen.

ACHTUNG: Der Rahmen über dem Gerät muss selbsttragend sein. Das Gerät ist nicht selbsttragend.

DEFINITIONEN

Brennbare Materialien - Materialien, die aus Holz, komprimiertem Papier, Pflanzenfasern, Kunststoffen oder anderen Materialien hergestellt oder damit beschichtet wurden. Materialien die entzündbar und brennbar sind, unabhängig davon, ob Flammen erzeugt werden oder nicht, gelten als brennbare Materialien.

Nicht brennbare Materialien - Materialien, die sich nicht entzündbar und brennbar sind. Solche Materialien sind solche, die vollständig aus Stahl, Eisen, Ziegel, Fliesen, Beton, Schiefer, Glas oder Putz oder einer Kombination davon bestehen. HardieBacker®, WonderBoard®, Durock® oder Materialien, die als ASTM E 136 (Standardprüfverfahren für das Verhalten von Materialien in einem Vertikalrohrföfen bei 750 ° C) eingestuft wurden, gelten als nicht brennbare Materialien.

HINWEIS: Die Abbildungen zeigen typische Installationen und dienen nur als Designvorlage. Abbildungen / Diagramme sind nicht Maßstabsgetreu. Die tatsächliche Installation kann aufgrund individueller Designvorlieben variieren.

VOR DEM EINBAU

1. Nehmen Sie die Firebox und die Komponenten vorsichtig aus der Verpackung.
2. Überprüfen Sie alle Teile, ob diese während des Transports beschädigt wurden, und prüfen Sie sie, insbesondere den Zustand der Glasscheibe.
3. Lesen Sie alle Anweisungen, bevor Sie mit der Installation beginnen. Befolgen Sie diese Anweisungen während der Installation sorgfältig, um ein Höchstmaß an Sicherheit und Nutzen zu gewährleisten.

WARNUNG: Brand- oder Explosionsgefahr! Beschädigte Teile können den sicheren Betrieb beeinträchtigen. Installieren Sie keine beschädigten oder unvollständigen Komponenten. Verwenden Sie nur originale Komponenten.

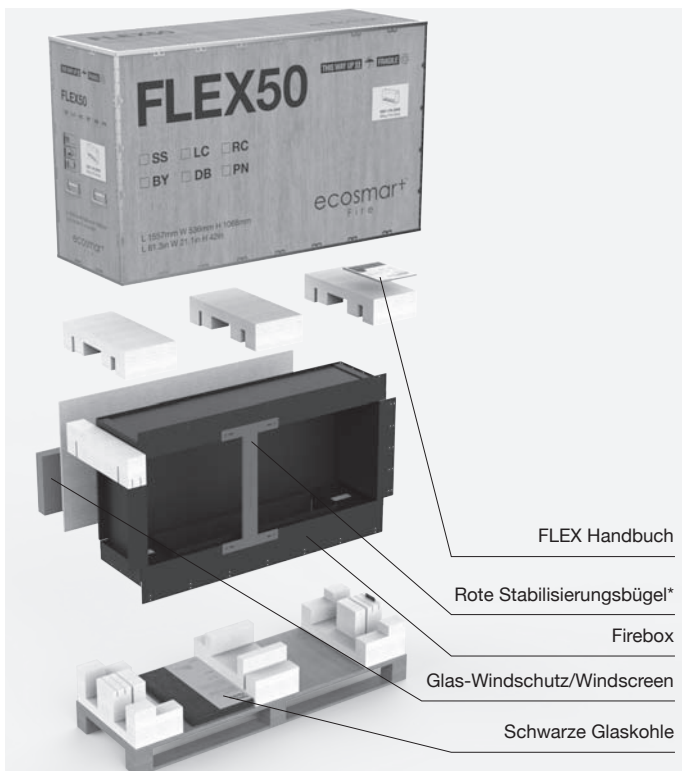
**Flex Verpackung**

*Nicht gültig für Flex- BENCH installation

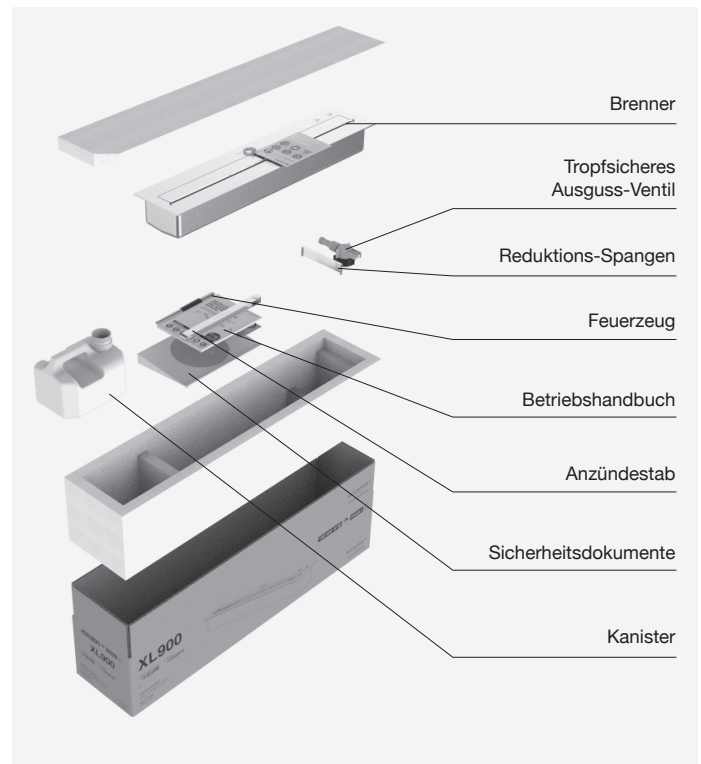
**Brennerkarton**

Einseitig geöffnete Installation

Erforderliche Ausrüstung: Bohrmaschine, Schraubendreher, Wasserwaage, Handspachtel für Gips, Silikonpistole

1. Konstruieren Sie den Hauptwandrahmen mit der in Tabelle A angegebenen Öffnungsgröße. Die Basis des Rahmens kann aus einer festen Bank / Plattform bestehen, die das Aufrichten des Geräts in Position unterstützt.



Tabelle A: Rahmenöffnungsgrößen

Die Abmessungen der Firebox sollten vor dem Zuschneiden anhand der ausgeschnittenen Abmessungen überprüft werden, bevor die Installation beginnt, um die Toleranzen zu bestätigen.

FIREBOX	B mm [in]	T mm [in]	H mm [in]	Gewicht* kg [lbs]
FLEX18SS	488 [19.2]	365 [14.4]	730 [28.7]	25.7 [56.5]
FLEX32SS	922 [36.3]	365 [14.4]	730 [28.7]	45.7 [100.5]
FLEX42SS	1177 [46.3]	365 [14.4]	730 [28.7]	60 [131.9]
FLEX50SS	1380 [54.3]	365 [14.4]	730 [28.7]	71.4 [157.1]
FLEX50SS.BX	1380 [54.3]	365 [14.4]	730 [28.7]	69.9 [153.8]
FLEX60SS.BX	1634 [64.3]	365 [14.4]	730 [28.7]	83.9 [184.6]
FLEX68SS	1840 [72.4]	365 [14.4]	730 [28.7]	97.1 [213.6]
FLEX68SS.BX	1840 [72.4]	365 [14.4]	730 [28.7]	95.1 [209.2]
FLEX68SS.BX2	1840 [72.4]	365 [14.4]	730 [28.7]	93.9 [206.7]
FLEX78SS.BX2	2090 [82.3]	365 [14.4]	730 [28.7]	107.8 [237.1]
FLEX86SS	2300 [90.5]	365 [14.4]	730 [28.7]	121.5 [267.3]
FLEX86SS.BX	2300 [90.5]	365 [14.4]	730 [28.7]	119.4 [262.7]
FLEX86SS.BX2	2300 [90.5]	365 [14.4]	730 [28.7]	118.8 [261.4]
FLEX104SS	2760 [108.7]	365 [14.4]	730 [28.7]	146.2 [321.6]
FLEX104SS.BX	2760 [108.7]	365 [14.4]	730 [28.7]	145.2 [319.4]
FLEX104SS.BX2	2760 [108.7]	365 [14.4]	730 [28.7]	193.8 [426.4]
FLEX122SS	3220 [126.7]	365 [14.4]	730 [28.7]	171.5 [377.3]
FLEX122SS.BX	3220 [126.7]	365 [14.4]	730 [28.7]	170.1 [374.2]
FLEX122SS.BX2	3220 [126.7]	365 [14.4]	730 [28.7]	168.9 [371.6]
FLEX140SS.BX	3680 [144.9]	365 [14.4]	730 [28.7]	195.2 [429.4]
FLEX140SS.BX2	3680 [144.9]	365 [14.4]	730 [28.7]	193.8 [426.4]
FLEX158SS	4140 [163]	365 [14.4]	730 [28.7]	222.1 [488.6]
FLEX158SS.BX2	4140 [163]	365 [14.4]	730 [28.7]	218.9 [481.6]

Das Gerätegewicht umfasst Brenner / s (Trockengewicht ohne Brennstoff), Glaskohle und Glas. Es enthält NICHT das Gewicht der Glaskohle für die Seitenkästen.

**WICHTIG: Der Rahmen über dem Gerät muss selbsttragend sein.
Das Gerät ist nicht selbsttragend.**

2. Schieben Sie die Firebox in den Rahmen (die Unterseite des Geräts kann direkt auf dem Rahmenmaterial sitzen). Die Firebox wird mit roten Stabilisierungsbügeln geliefert, die an der/den offenen Seite/n angebracht sind, um das Gerät während des Transports und während der Installation rechteckig zu halten. Entfernen Sie die Stabilisierungsbügel erst nach dem Einbau in den Rahmen, dies hilft die Firebox während des Einbaus rechteckig zu halten.

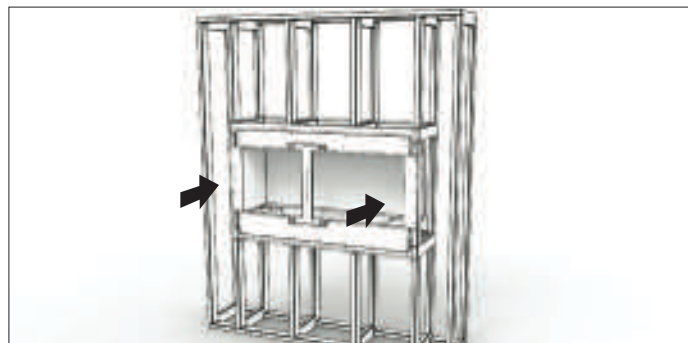

3. Befestigen Sie das Gerät mit den vorhandenen Montagelöchern an den Geräteflanschen mit Schrauben am Rahmen. Stellen Sie sicher, dass das Gerät waagrecht steht, bevor Sie es befestigen.



4. Entfernen Sie die roten Stabilisierungsbügel.

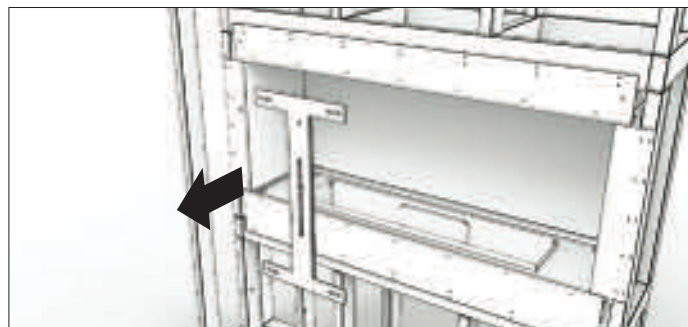

Einseitig geöffnete Installation

5. Schließen Sie die Konstruktion ab, indem Sie die Wandverkleidung um das Gerät herum fertigstellen. (Siehe Abschnitt **“EINBAU ANWEISUNGEN”**) und vergewissern Sie sich, dass Sie genau wissen, wo nicht brennbare Materialien verwendet werden müssen.

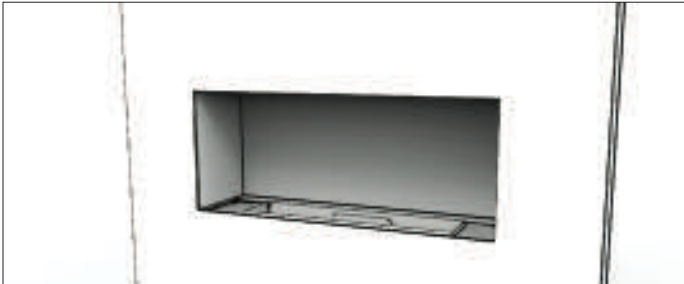

6. Setzen Sie den Brenner in Firebox ein.



7. Entfernen Sie den Staubschutz, welches die Montageschlitz für Windschutzscheibe abdeckt.

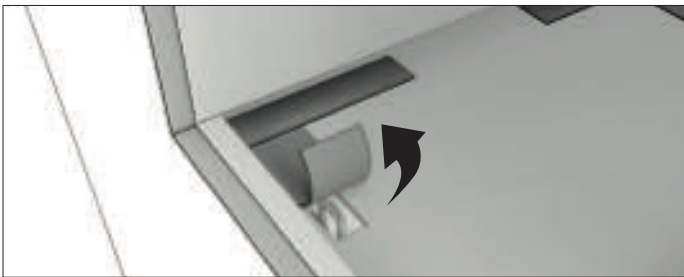

8. Wenn Ihr Gerät links / rechts oder in beiden Fällen mit einer dekorativen Box ausgestattet ist, setzen Sie die Glasscheibe/n ein, indem Sie das Glas nach oben in den Schlitz einführen und dann nach unten in die positionierten Clips drücken.

** Dekorative Holzscheite dürfen NICHT direkt über einer offenen Flamme platziert werden. Sie sind so konzipiert, dass sie in der Nähe von Hitze positioniert werden, jedoch nicht direkt über Flammen.*

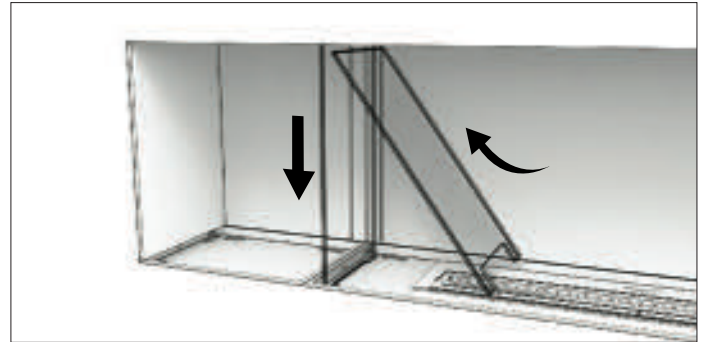

9. Installieren Sie die Windschutzscheibe, indem Sie die beiden Enden in die entsprechenden Schlitz des Geräts einführen. Drücken Sie die Windschutzscheibe mit etwas Druck in Position, bis sie in die verborgenen Glasclips einrastet.

WARNUNG: Das verwendete Glas ist gehärtetes Glas - das heißt, es ist stärker als normales Glas. Obwohl es stärker ist, weist gehärtetes Glas immer noch Schwächen auf. Die Ecken und Seiten sind spezifische Druckpunkte, an denen es anfälliger ist und bei Nichtbeachtung brechen kann. Gehärtetes Glas bricht in viele kleine Stücke. Achten Sie darauf, sich nicht an dem Glas zu schneiden. Wir empfehlen Ihnen, beim Umgang mit Glas Schutzhandschuhe zu tragen.



10. Verteilen Sie die Glaskohle gleichmäßig um die Gerätewanne. **ACHTUNG:** Stellen Sie sicher, dass der Brennerdeckel geschlossen ist. Halten Sie die Glaskohle vom Brennerflansch fern, damit die Glaskohle nicht versehentlich in die Brennkammer gelangt. Achten Sie darauf, den Brenner nicht zu zerkratzen.

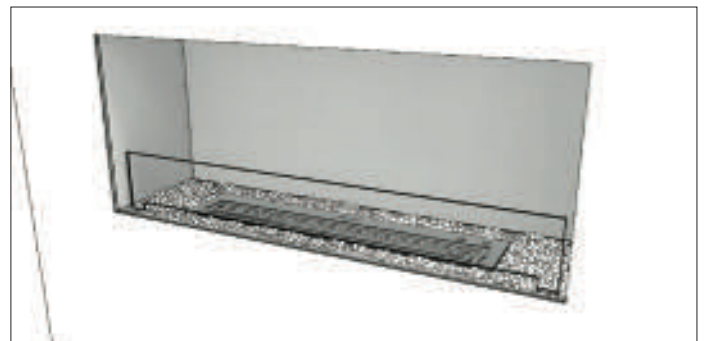

Linksseitig geöffnete & Rechtsseitig geöffnete Installation

Erforderliche Ausrüstung: Bohrmaschine, Schraubendreher, Wasserwaage, Handspachtel für Gips, Silikonpistole

1. Konstruieren Sie den Hauptwandrahmen mit der in Tabelle B angegebenen Öffnungsgröße. Die Basis des Rahmens kann aus einer festen Bank / Plattform bestehen, die das Aufrichten des Geräts in Position unterstützt.

Abbildungen zeigen die Installation einer Linksseitig geöffneten Firebox.



Tabelle B: Rahmenöffnungsgrößen

Die Abmessungen der Firebox sollten vor dem Zuschneiden anhand der ausgeschnittenen Abmessungen überprüft werden, bevor die Installation beginnt, um die Toleranzen zu bestätigen.

FIREBOX (LC & RC)	B mm [in]	T mm [in]	H mm [in]	Gewicht* kg [lbs]
FLEX18LC	470 [18.5]	365 [14.4]	730 [28.7]	33 [72.6]
FLEX32LC	902 [35.5]	365 [14.4]	730 [28.7]	48.8 [107.4]
FLEX42LC	1157 [45.5]	365 [14.4]	730 [28.7]	63.3 [139.3]
FLEX50LC	1362 [53.6]	365 [14.4]	730 [28.7]	71.6k [157.5]
FLEX50LC.BX	1362 [53.6]	365 [14.4]	730 [28.7]	73.1 [160.8]
FLEX60LC.BX	1617 [63.7]	365 [14.4]	730 [28.7]	87.1 [191.6]
FLEX68LC	1822 [71.7]	365 [14.4]	730 [28.7]	100.3 [220.7]
FLEX68LC.BX	1822 [71.7]	365 [14.4]	730 [28.7]	95.3 [209.7]
FLEX68LC.BX2	1822 [71.7]	365 [14.4]	730 [28.7]	97kg [213.4]
FLEX78LC.BX2	2077 [81.8]	365 [14.4]	730 [28.7]	111 [244.2]
FLEX86LC	2282 [89.8]	365 [14.4]	730 [28.7]	121.7 [267.7]
FLEX86LC.BX	2282 [89.8]	365 [14.4]	730 [28.7]	122.6 [269.7]
FLEX86LC.BX2	2282 [89.8]	365 [14.4]	730 [28.7]	119 [261.8]
FLEX104LC	2742 [107.9]	365 [14.4]	730 [28.7]	149.5 [328.9]
FLEX104LC.BX	2742 [107.9]	365 [14.4]	730 [28.7]	145.4 [319.9]
FLEX104LC.BX2	2742 [107.9]	365 [14.4]	730 [28.7]	146.9 [323.2]
FLEX122LC	3202 [126.1]	365 [14.4]	730 [28.7]	171.7 [377.7]
FLEX122LC.BX	3202 [126.1]	365 [14.4]	730 [28.7]	173.4 [381.5]
FLEX122LC.BX2	3202 [126.1]	365 [14.4]	730 [28.7]	169.1 [372]
FLEX140LC.BX	3662 [144.2]	365 [14.4]	730 [28.7]	197.1 [433.6]
FLEX140LC.BX2	3662 [144.2]	365 [14.4]	730 [28.7]	195.4 [429.9]
FLEX158LC	4122 [162.3]	365 [14.4]	730 [28.7]	225.5 [496.1]
FLEX158LC.BX2	4122 [162.3]	365 [14.4]	730 [28.7]	219.1 [482]

Das Gerätegewicht umfasst Brenner / s (Trockengewicht ohne Brennstoff), Glaskohle und Glas. Es enthält NICHT das Gewicht der Glaskohle für die Seitenkästen.

WICHTIG: Der Rahmen über dem Gerät muss selbsttragend sein. Das Gerät ist nicht selbsttragend.

2. Schieben Sie die Firebox in den Rahmen (die Unterseite des Geräts kann direkt auf dem Rahmenmaterial sitzen). Die Firebox wird mit roten Stabilisierungsbügeln geliefert, die an der/den offenen Seite/n angebracht sind, um das Gerät während des Transports und während der Installation rechteckig zu halten. Entfernen Sie die Stabilisierungsbügel erst nach dem Einbau in den Rahmen, dies hilft die Firebox während des Einbaus rechteckig zu halten. Richten Sie die obere Eckflansch-Erweiterungsplatte an den Gewindebohrungen auf der oberen Ablagefläche aus und schrauben Sie sie mit den mitgelieferten Schrauben fest.

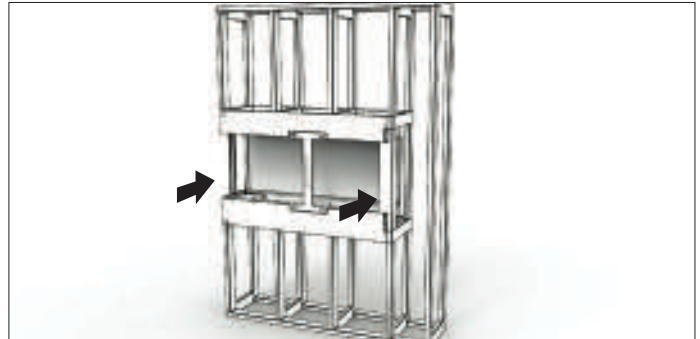

3. Befestigen Sie das Gerät mit den vorhandenen Montagelöchern an den Geräteflanschen mit Schrauben am Rahmen. Stellen Sie sicher, dass das Gerät waagrecht steht, bevor Sie es befestigen.



4. Entfernen Sie die roten Stabilisierungsbügel.

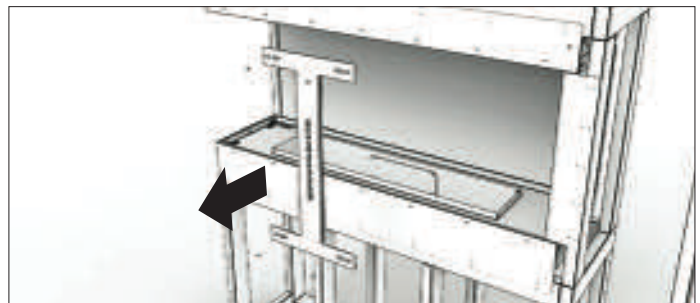

Linksseitig geöffnete & Rechtsseitig geöffnete Installation

5. Schließen Sie die Konstruktion ab, indem Sie die Wandverkleidung um das Gerät herum fertigstellen. (Siehe Abschnitt **"EINBAU ANWEISUNGEN"**) und vergewissern Sie sich, dass Sie genau wissen, wo nicht brennbare Materialien verwendet werden müssen.



6. Setzen Sie den Brenner in Firebox ein.

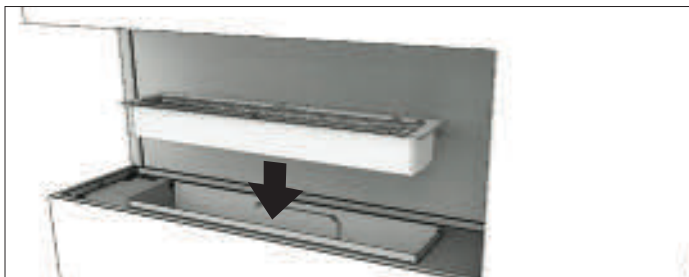

7. Entfernen Sie den Staubschutz, welches die Montageschlitz für Windschutzscheibe abdeckt.

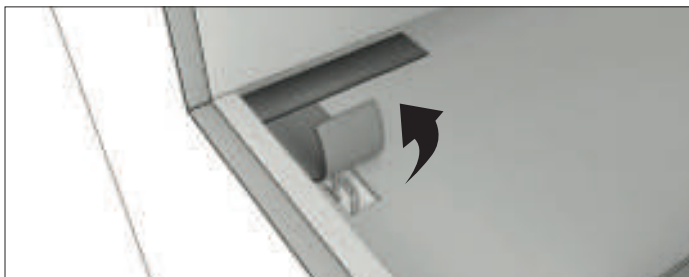

8. Wenn Ihr Gerät links / rechts oder in beiden Fällen mit einer dekorativen Box ausgestattet ist, setzen Sie die Glasscheibe/n ein, indem Sie das Glas nach oben in den Schlitz einführen und dann nach unten in die positionierten Clips drücken.

** Dekorative Holzscheite dürfen NICHT direkt über einer offenen Flamme platziert werden. Sie sind so konzipiert, dass sie in der Nähe von Hitze positioniert werden, jedoch nicht direkt über Flammen.*

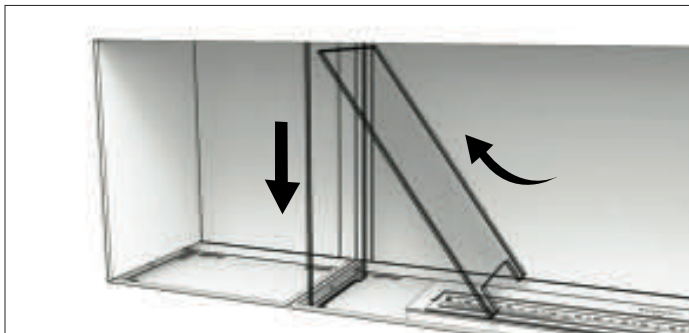

9. Setzen Sie die Glasscheibe mit voller Höhe in eine der offenen Enden ein, indem Sie das Glas in die Öffnung oben am Gerät einsetzen und es in die Schlitz in der Basis absenken, bis es einrastet.



10. Installieren Sie die Windschutzscheibe, indem Sie die beiden Enden in die entsprechenden Schlitz des Geräts einführen. Drücken Sie die Windschutzscheibe mit etwas Druck in Position, bis sie in die verborgenen Glasclips einrastet.

WARNUNG: Das verwendete Glas ist gehärtetes Glas - das heißt, es ist stärker als normales Glas. Obwohl es stärker ist, weist gehärtetes Glas immer noch Schwächen auf. Die Ecken und Seiten sind spezifische Druckpunkte, an denen es anfälliger ist und bei Nichtbeachtung brechen kann. Gehärtetes Glas bricht in viele kleine Stücke. Achten Sie darauf, sich nicht an dem Glas zu schneiden. Wir empfehlen Ihnen, beim Umgang mit Glas Schutzhandschuhe zu tragen.



11. Verteilen Sie die Glaskohle gleichmäßig um die Gerätewanne. **ACHTUNG:** Stellen Sie sicher, dass der Brennerdeckel geschlossen ist. Halten Sie die Glaskohle vom Brennerflansch fern, damit die Glaskohle nicht versehentlich in die Brennkammer gelangt. Achten Sie darauf, den Brenner nicht zu zerkratzen.



Bay Installation

Erforderliche Ausrüstung: Bohrmaschine, Schraubendreher, Wasserwaage, Handspachtel für Gips, Silikonpistole

1. Konstruieren Sie den Hauptwandrahmen mit der in Tabelle C angegebenen Öffnungsgröße. Die Basis des Rahmens kann aus einer festen Bank / Plattform bestehen, die das Aufrichten des Geräts in Position unterstützt.



Tabelle C: Rahmenöffnungsgrößen

Die Abmessungen der Firebox sollten vor dem Zuschneiden anhand der ausgeschnittenen Abmessungen überprüft werden, bevor die Installation beginnt, um die Toleranzen zu bestätigen.

FIREBOX	B mm [in]	T mm [in]	H mm [in]	Gewicht* kg [lbs]
FLEX18BY	460 [18.1]	365 [14.4]	730 [28.7]	40.7 [89.5]
FLEX32BY	892 [35.1]	365 [14.4]	730 [28.7]	51.9 [114.2]
FLEX42BY	1147 [45.2]	365 [14.4]	730 [28.7]	66.5 [146.3]
FLEX50BY	1352 [53.2]	365 [14.4]	730 [28.7]	71.8 [158]
FLEX50BY.BX	1353 [53.3]	365 [14.4]	730 [28.7]	76.2 [167.6]
FLEX60BY.BX	1608 [63.3]	365 [14.4]	730 [28.7]	90.3 [198.7]
FLEX68BY	1813 [71.4]	365 [14.4]	730 [28.7]	103.6 [227.9]
FLEX68BY.BX	1813 [71.4]	365 [14.4]	730 [28.7]	95.5 [210.1]
FLEX68BY.BX2	1813 [71.4]	365 [14.4]	730 [28.7]	100.2 [220.4]
FLEX78BY.BX2	2068 [81.4]	365 [14.4]	730 [28.7]	114 [250.8]
FLEX86BY	2272 [89.4]	365 [14.4]	730 [28.7]	121.9 [268.2]
FLEX86BY.BX	2272 [89.4]	365 [14.4]	730 [28.7]	125.9 [277]
FLEX86BY.BX2	2272 [89.4]	365 [14.4]	730 [28.7]	119.2 [262.2]
FLEX104BY	2733 [107.6]	365 [14.4]	730 [28.7]	152.9 [336.4]
FLEX104BY.BX	2733 [107.6]	365 [14.4]	730 [28.7]	145.6 [320.3]
FLEX104BY.BX2	2733 [107.6]	365 [14.4]	730 [28.7]	150.1 [330.2]
FLEX122BY	3193 [125.7]	365 [14.4]	730 [28.7]	171.9 [378.2]
FLEX122BY.BX	3193 [125.7]	365 [14.4]	730 [28.7]	176.7 [388.7]
FLEX122BY.BX2	3193 [125.7]	365 [14.4]	730 [28.7]	169.3 [372.5]
FLEX140BY.BX	3653 [143.8]	365 [14.4]	730 [28.7]	195.6 [430.3]
FLEX140BY.BX2	3653 [143.8]	365 [14.4]	730 [28.7]	200.3 [440.7]
FLEX158BY	4113 [161.9]	365 [14.4]	730 [28.7]	228.8 [503.4]
FLEX158BY.BX2	4113 [161.9]	365 [14.4]	730 [28.7]	219.3 [482.5]

Das Gerätegewicht umfasst Brenner / s (Trockengewicht ohne Brennstoff), Glaskohle und Glas. Es enthält NICHT das Gewicht der Glaskohle für die Seitenkästen.

WICHTIG: Der Rahmen über dem Gerät muss selbsttragend sein. Das Gerät ist nicht selbsttragend.

2. Schieben Sie die Firebox in den Rahmen (die Unterseite des Geräts kann direkt auf dem Rahmenmaterial sitzen). Die Firebox wird mit roten Stabilisierungsbügeln geliefert, die an der/den offenen Seite/n angebracht sind, um das Gerät während des Transports und während der Installation rechteckig zu halten. Entfernen Sie die Stabilisierungsbügel erst nach dem Einbau in den Rahmen, dies hilft die Firebox während des Einbaus rechteckig zu halten.

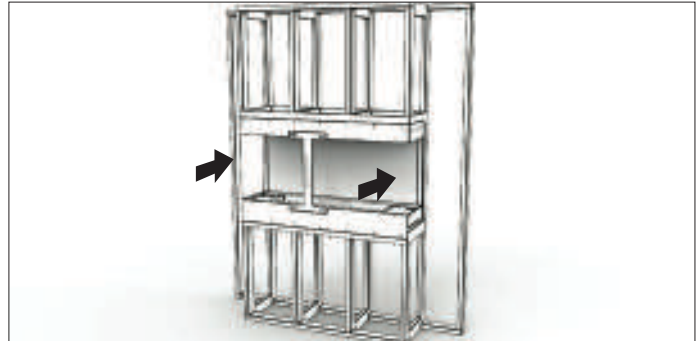

3. Stellen Sie sicher, dass die linke und rechte Seitenkante des Geräts bündig mit dem Rahmen sind.

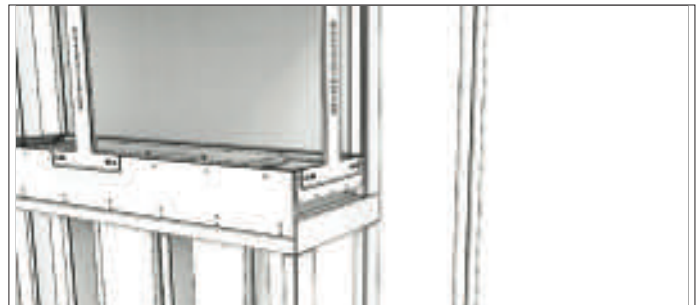

4. Befestigen Sie das Gerät mit den vorhandenen Montagelöchern an den Geräteflanschen mit Schrauben am Rahmen. Stellen Sie sicher, dass das Gerät waagrecht steht, bevor Sie es befestigen.

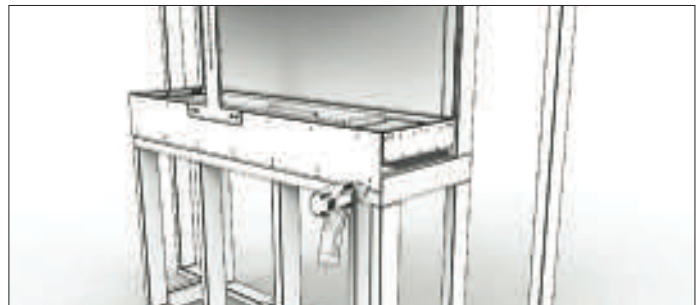

5. Entfernen Sie die roten Stabilisierungsbügel.

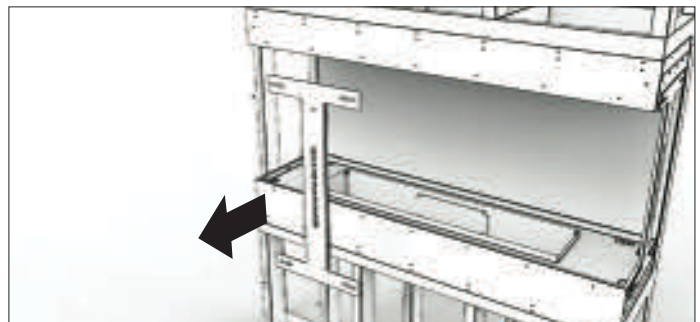

Bay Installation

30

6. Schließen Sie die Konstruktion ab, indem Sie die Wandverkleidung um das Gerät herum fertigstellen. (Siehe Abschnitt **"EINBAU ANWEISUNGEN"**) und vergewissern Sie sich, dass Sie genau wissen, wo nicht brennbare Materialien verwendet werden müssen.

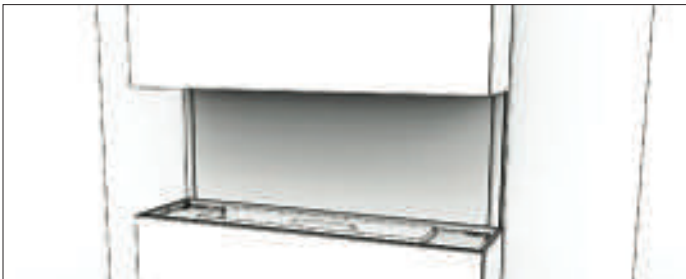

7. Setzen Sie den Brenner in Firebox ein.

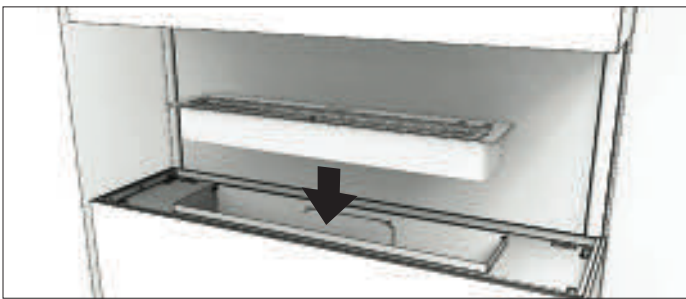

8. Entfernen Sie den Staubschutz, welches die Montageschlitz für Windschutzscheibe abdeckt.

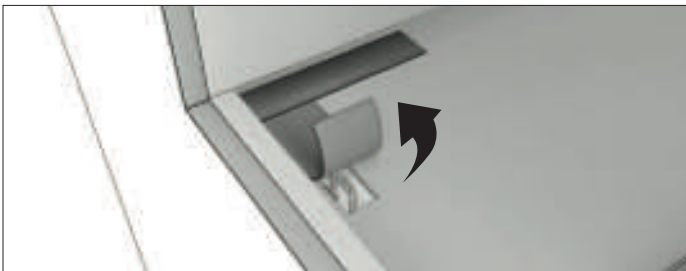

9. Wenn Ihr Gerät links / rechts oder in beiden Fällen mit einer dekorativen Box ausgestattet ist, setzen Sie die Glasscheibe/n ein, indem Sie das Glas nach oben in den Schlitz einführen und dann nach unten in die positionierten Clips drücken.

** Dekorative Holzseite dürfen NICHT direkt über einer offenen Flamme platziert werden. Sie sind so konzipiert, dass sie in der Nähe von Hitze positioniert werden, jedoch nicht direkt über Flammen.*

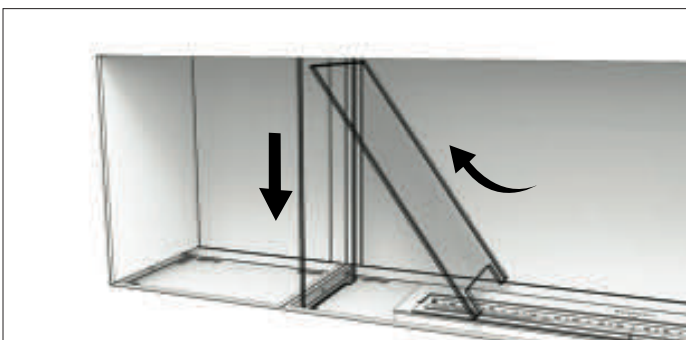

10. Setzen Sie die Glasscheibe mit voller Höhe in eine der offenen Enden ein, indem Sie das Glas in die Öffnung oben am Gerät einsetzen und es in die Schlitz in der Basis absenken, bis es einrastet. Wiederholen Sie dasselbe für die andere Seite des Geräts.

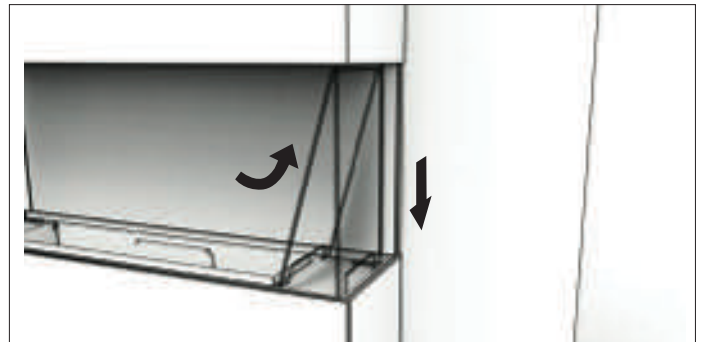

11. Installieren Sie die Windschutzscheibe, indem Sie die beiden Enden in die entsprechenden Schlitz des Geräts einführen. Drücken Sie die Windschutzscheibe mit etwas Druck in Position, bis sie in die verborgenen Glasclips einrastet.

WARNUNG: Das verwendete Glas ist gehärtetes Glas - das heißt, es ist stärker als normales Glas. Obwohl es stärker ist, weist gehärtetes Glas immer noch Schwächen auf. Die Ecken und Seiten sind spezifische Druckpunkte, an denen es anfälliger ist und bei Nichtbeachtung brechen kann. Gehärtetes Glas bricht in viele kleine Stücke. Achten Sie darauf, sich nicht an dem Glas zu schneiden. Wir empfehlen Ihnen, beim Umgang mit Glas Schutzhandschuhe zu tragen.

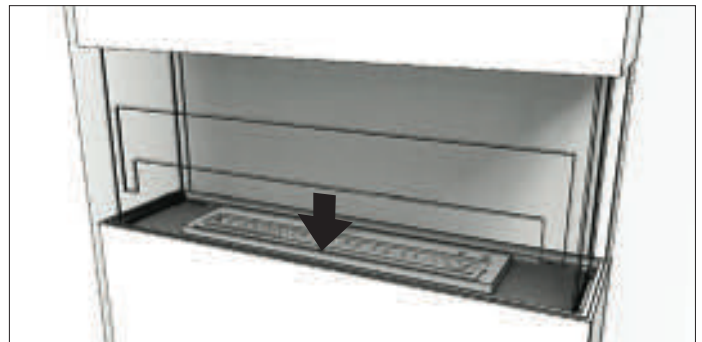

12. Verteilen Sie die Glaskohle gleichmäßig um die Gerätewanne. **ACHTUNG:** Stellen Sie sicher, dass der Brennerdeckel geschlossen ist. Halten Sie die Glaskohle vom Brennerflansch fern, damit die Glaskohle nicht versehentlich in die Brennkammer gelangt. Achten Sie darauf, den Brenner nicht zu zerkratzen.

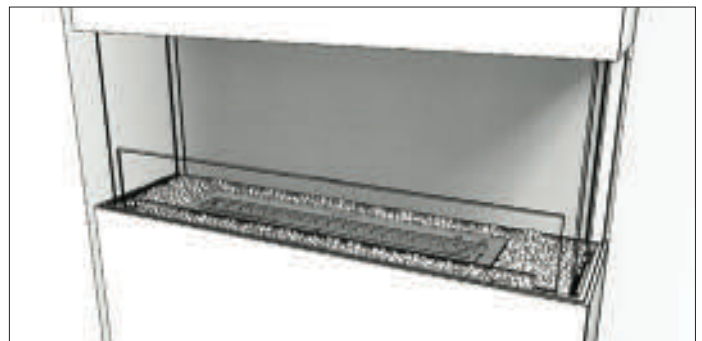

Beidseitig geöffnete Installation

Erforderliche Ausrüstung: Bohrmaschine, Schraubendreher, Wasserwaage, Handspachtel für Gips, Silikonpistole

1. Konstruieren Sie den Hauptwandrahmen mit der in Tabelle D angegebenen Öffnungsgröße. Die Basis des Rahmens kann aus einer festen Bank / Plattform bestehen, die das Aufrichten des Geräts in Position unterstützt.

WARNUNG: Beidseitig geöffnete Geräte können nicht in eine einseitig geöffnete Wand eingesetzt werden. Es muss sich um eine Zweibegeöffnung handeln, bei der das Glas auf beiden Seiten frei von Hindernissen ist. Üben Sie keinen Druck auf das Glas aus. Tragen sie keine zusätzlichen Materialien auf. Doppelseitige Geräte sind als Trennwandensätze konzipiert. Wenn Sie diese Installationsanweisung nicht einhalten, kann sich die Wand überhitzen und Feuer fangen.



Tabelle D: Rahmenöffnungsgrößen

Die Abmessungen der Firebox sollten vor dem Zuschneiden anhand der ausgeschnittenen Abmessungen überprüft werden, bevor die Installation beginnt, um die Toleranzen zu bestätigen.

FIREBOX	B mm [in]	T mm [in]	H mm [in]	Gewicht* kg [lbs]
FLEX18DB	488 [19.2]	349 [13.6]	730 [28.7]	26.5 [58.3]
FLEX32DB	922 [36.3]	349 [13.6]	730 [28.7]	46.6 [102.5]
FLEX42DB	1177 [46.3]	349 [13.6]	730 [28.7]	61.4 [135.1]
FLEX50DB	1380 [54.3]	349 [13.6]	730 [28.7]	70.8 [155.8]
FLEX50DB.BX	1380 [54.3]	349 [13.6]	730 [28.7]	70 [154]
FLEX60DB.BX	1634 [64.3]	349 [13.6]	730 [28.7]	83.3 [183.3]
FLEX68DB	1840 [72.4]	349 [13.6]	730 [28.7]	95.5 [210.1]
FLEX68DB.BX	1840 [72.4]	349 [13.6]	730 [28.7]	83.7 [184.1]
FLEX68DB.BX2	1840 [72.4]	349 [13.6]	730 [28.7]	94.8 [208.6]
FLEX78DB.BX2	2090 [82.3]	349 [13.6]	730 [28.7]	106.2 [233.6]
FLEX86DB	2300 [90.5]	349 [13.6]	730 [28.7]	102.3 [225.1]
FLEX86DB.BX	2300 [90.5]	349 [13.6]	730 [28.7]	124.5 [273.9]
FLEX86DB.BX2	2300 [90.5]	349 [13.6]	730 [28.7]	108.5 [238.7]
FLEX104DB	2760 [108.7]	349 [13.6]	730 [28.7]	145.7 [320.5]
FLEX104DB.BX	2760 [108.7]	349 [13.6]	730 [28.7]	127.1 [279.6]
FLEX104DB.BX2	2760 [108.7]	349 [13.6]	730 [28.7]	142 [312]
FLEX122DB	3220 [126.7]	349 [13.6]	730 [28.7]	145.6 [320.3]
FLEX122DB.BX	3220 [126.7]	349 [13.6]	730 [28.7]	170.1 [374.2]
FLEX122DB.BX2	3220 [126.7]	349 [13.6]	730 [28.7]	151.9 [334.2]
FLEX140DB.BX	3680 [144.9]	349 [13.6]	730 [28.7]	170.4 [374.9]
FLEX140DB.BX2	3680 [144.9]	349 [13.6]	730 [28.7]	192.9 [424.4]
FLEX158DB	4140 [163]	349 [13.6]	730 [28.7]	226.8 [499]
FLEX158DB.BX2	4140 [163]	349 [13.6]	730 [28.7]	195.2 [429.4]

Das Gerätegewicht umfasst Brenner / s (Trockengewicht ohne Brennstoff), Glaskohle und Glas. Es enthält NICHT das Gewicht der Glaskohle für die Seitenkästen.

WICHTIG: Der Rahmen über dem Gerät muss selbsttragend sein. Das Gerät ist nicht selbsttragend.

2. Entfernen Sie den Verlängerungsflansch von der Firebox, so dass beide Seiten die gleiche Höhe haben. Dies erleichtert das Einschleiben der Firebox in den Rahmen. Achten Sie darauf, die Schrauben nicht zu verlieren. Sie werden erneut benötigt, wenn der Flansch wieder montiert wird.

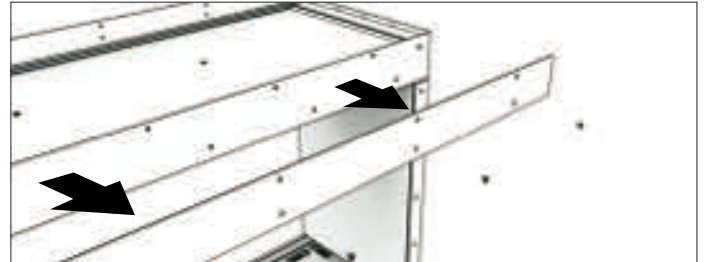

3. Schieben Sie die Firebox in den Rahmen (die Unterseite des Geräts kann direkt auf dem Rahmenmaterial sitzen). Die Firebox wird mit roten Stabilisierungsbügeln geliefert, die an der/den offenen Seite/n angebracht sind, um das Gerät während des Transports und während der Installation rechteckig zu halten. Entfernen Sie die Stabilisierungsbügel erst nach dem Einbau in den Rahmen, dies hilft die Firebox während des Einbaus rechteckig zu halten.

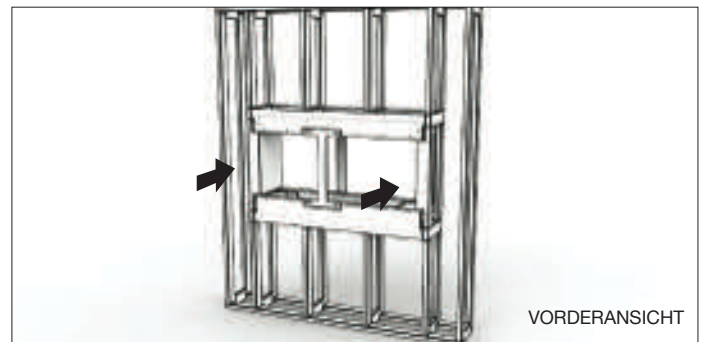

4. Richten Sie die Flanschverlängerungsplatte an den Gewindebohrungen am Gerät aus. Schrauben Sie es mit den mitgelieferten Schrauben fest (untere Reihe am Gerät, obere Reihe am Rahmenmaterial).



5. Befestigen Sie das Gerät mit den vorhandenen Montagelöchern an den Geräteflanschen mit Schrauben am Rahmen. Stellen Sie sicher, dass das Gerät waagrecht steht, bevor Sie es befestigen.

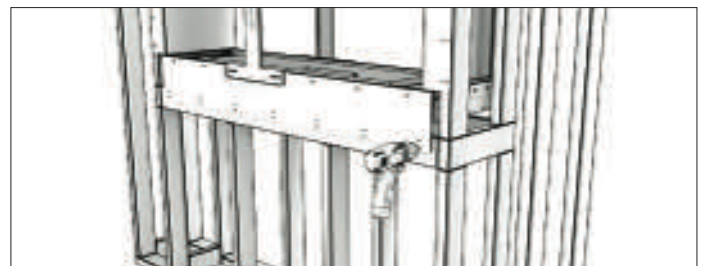

Beidseitig geöffnete Installation

6. Entfernen Sie die roten Stabilisierungsbügel.

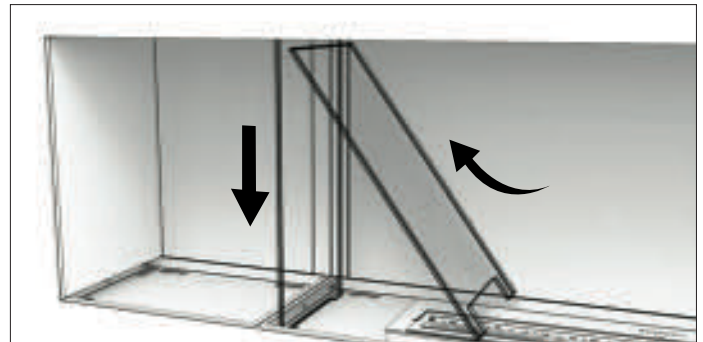

7. Schließen Sie die Konstruktion ab, indem Sie die Wandverkleidung um das Gerät herum fertigstellen. (Siehe Abschnitt **“EINBAU ANWEISUNGEN”**) und vergewissern Sie sich, dass Sie genau wissen, wo nicht brennbare Materialien verwendet werden müssen.

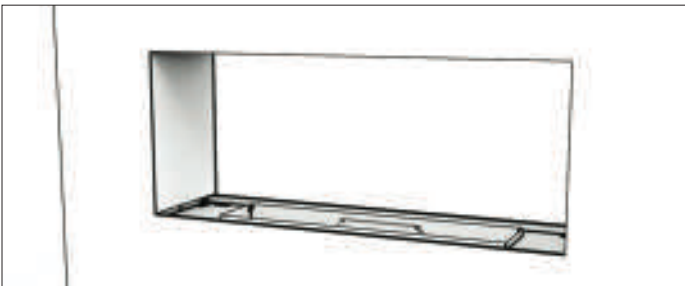

8. Setzen Sie den Brenner in Firebox ein.

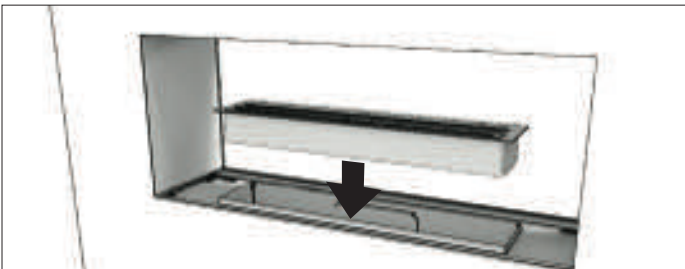

9. Entfernen Sie den Staubschutz, welches die Montageschlitz für Windschutzscheibe abdeckt.

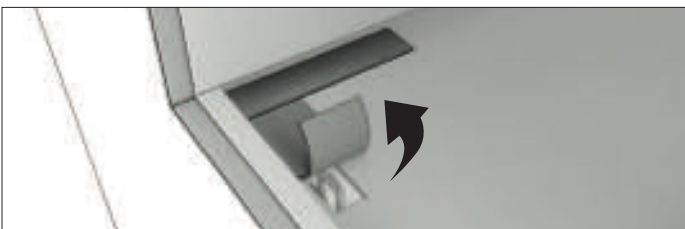

10. Wenn Ihr Gerät links / rechts oder in beiden Fällen mit einer dekorativen Box ausgestattet ist, setzen Sie die Glasscheibe/n ein, indem Sie das Glas nach oben in den Schlitz einführen und dann nach unten in die positionierten Clips drücken.

** Dekorative Holzscheite dürfen NICHT direkt über einer offenen Flamme platziert werden. Sie sind so konzipiert, dass sie in der Nähe von Hitze positioniert werden, jedoch nicht direkt über Flammen.*

11. Installieren Sie die Windschutzscheibe, indem Sie die beiden Enden in die entsprechenden Schlitz des Geräts einführen. Drücken Sie die Windschutzscheibe mit etwas Druck in Position, bis sie in die verborgenen Glasclips einrastet.

WARNUNG: Das verwendete Glas ist gehärtetes Glas - das heißt, es ist stärker als normales Glas. Obwohl es stärker ist, weist gehärtetes Glas immer noch Schwächen auf. Die Ecken und Seiten sind spezifische Druckpunkte, an denen es anfälliger ist und bei Nichtbeachtung brechen kann. Gehärtetes Glas bricht in viele kleine Stücke. Achten Sie darauf, sich nicht an dem Glas zu schneiden. Wir empfehlen Ihnen, beim Umgang mit Glas Schutzhandschuhe zu tragen.

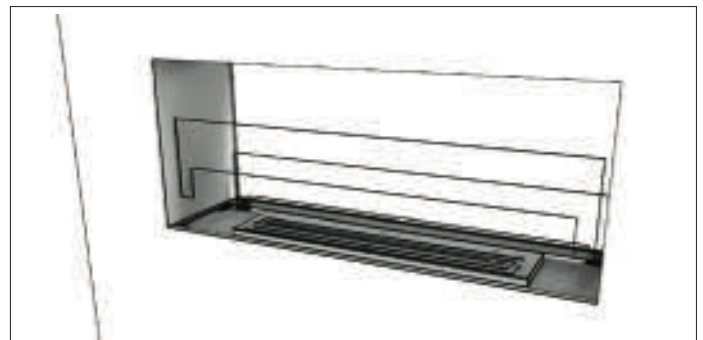

12. Verteilen Sie die Glaskohle gleichmäßig um die Gerätewanne. **ACHTUNG:** Stellen Sie sicher, dass der Brennerdeckel geschlossen ist. Halten Sie die Glaskohle vom Brennerflansch fern, damit die Glaskohle nicht versehentlich in die Brennkammer gelangt. Achten Sie darauf, den Brenner nicht zu zerkratzen.

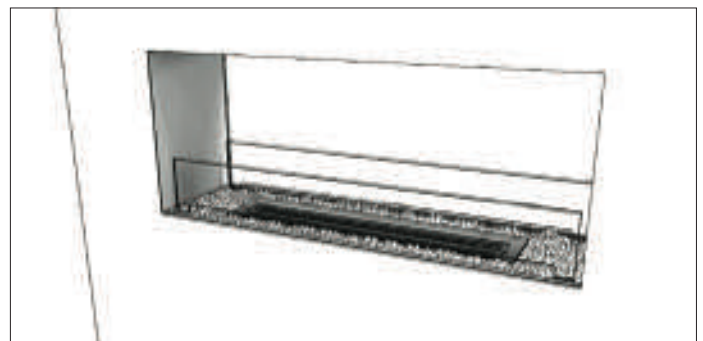

Peninsula Installation

Erforderliche Ausrüstung: Bohrmaschine, Schraubendreher, Wasserwaage, Handspachtel für Gips, Silikonpistole

1. Konstruieren Sie den Hauptwandrahmen mit der in Tabelle E angegebenen Öffnungsgröße. Die Basis des Rahmens kann aus einer festen Bank / Plattform bestehen, die das Aufrichten des Geräts in Position unterstützt.

WARNUNG: Dreiseitig geöffnete Geräte können nicht in eine einseitig geöffnete Wand eingesetzt werden. Es muss sich um eine Dreibeigeöffnung handeln, bei der das Glas auf allen Seiten frei von Hindernissen ist. Üben Sie keinen Druck auf das Glas aus. Tragen Sie keine zusätzlichen Materialien auf. Dreiseitige Geräte sind als Trennwandensätze konzipiert. Wenn Sie diese Installationsanweisung nicht einhalten, kann sich die Wand überhitzen und Feuer fangen.



Tabelle E: Rahmenöffnungsgrößen

Die Abmessungen der Firebox sollten vor dem Zuschneiden anhand der ausgeschnittenen Abmessungen überprüft werden, bevor die Installation beginnt, um die Toleranzen zu bestätigen.

FIREBOX	B mm [in]	T mm [in]	H mm [in]	Gewicht* kg [lbs]
FLEX18PN	470 [18.5]	349 [13.6]	730 [28.7]	34.2 [75.2]
FLEX32PN	902 [35.5]	349 [13.6]	730 [28.7]	49.8 [109.6]
FLEX42PN	1157 [45.5]	349 [13.6]	730 [28.7]	64.7 [142.3]
FLEX50PN	1362 [53.6]	349 [13.6]	730 [28.7]	59.1 [130]
FLEX50PN.BX	1362 [53.6]	349 [13.6]	730 [28.7]	73.2 [161]
FLEX60PN.BX	1617 [63.7]	349 [13.6]	730 [28.7]	87.5 [192.5]
FLEX68PN	1822 [71.7]	349 [13.6]	730 [28.7]	102.8 [226.2]
FLEX68PN.BX	1822 [71.7]	349 [13.6]	730 [28.7]	83.9 [184.6]
FLEX68PN.BX2	1822 [71.7]	349 [13.6]	730 [28.7]	96.1 [211.4]
FLEX78PN.BX2	2077 [81.8]	349 [13.6]	730 [28.7]	110.4 [242.9]
FLEX86PN	2282 [89.8]	349 [13.6]	730 [28.7]	102.5 [225.5]
FLEX86PN.BX	2282 [89.8]	349 [13.6]	730 [28.7]	124.1 [273]
FLEX86PN.BX2	2282 [89.8]	349 [13.6]	730 [28.7]	108.7 [239.1]
FLEX104PN	2742 [107.9]	349 [13.6]	730 [28.7]	153.3 [337.3]
FLEX104PN.BX	2742 [107.9]	349 [13.6]	730 [28.7]	127.3 [280.1]
FLEX104PN.BX2	2742 [107.9]	349 [13.6]	730 [28.7]	147.3 [324.1]
FLEX122PN	3202 [126.1]	349 [13.6]	730 [28.7]	145.8 [320.8]
FLEX122PN.BX	3202 [126.1]	349 [13.6]	730 [28.7]	176.2 [387.6]
FLEX122PN.BX2	3202 [126.1]	349 [13.6]	730 [28.7]	152.1 [334.6]
FLEX140PN.BX	3662 [144.2]	349 [13.6]	730 [28.7]	170.6 [375.3]
FLEX140PN.BX2	3662 [144.2]	349 [13.6]	730 [28.7]	198.7 [437.1]
FLEX158PN	4122 [162.3]	349 [13.6]	730 [28.7]	231.8 [510]
FLEX158PN.BX2	4122 [162.3]	349 [13.6]	730 [28.7]	195.4 [429.9]

Das Gerätegewicht umfasst Brenner / s (Trockengewicht ohne Brennstoff), Glaskohle und Glas. Es enthält NICHT das Gewicht der Glaskohle für die Seitenkästen.

WICHTIG: Der Rahmen über dem Gerät muss selbsttragend sein. Das Gerät ist nicht selbsttragend.

2. Entfernen Sie den Verlängerungsflansch von der Firebox, so dass beide Seiten die gleiche Höhe haben. Dies erleichtert das Einschleiben der Firebox in den Rahmen. Achten Sie darauf, die Schrauben nicht zu verlieren. Sie werden erneut benötigt, wenn der Flansch wieder montiert wird.

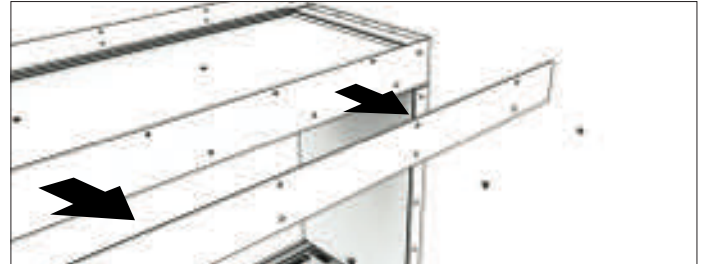

3. Schieben Sie die Firebox in den Rahmen (die Unterseite des Geräts kann direkt auf dem Rahmenmaterial sitzen). Die Firebox wird mit roten Stabilisierungsbügeln geliefert, die an der/den offenen Seite/n angebracht sind, um das Gerät während des Transports und während der Installation rechteckig zu halten. Entfernen Sie die Stabilisierungsbügel erst nach dem Einbau in den Rahmen, dies hilft die Firebox während des Einbaus rechteckig zu halten.

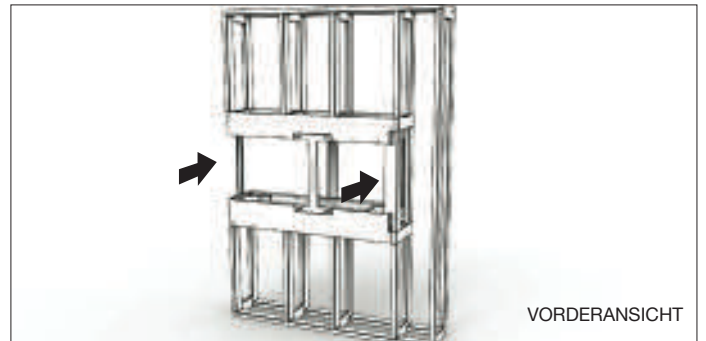

4. Stellen Sie sicher, dass die hintere und offene Seitenkante des Geräts mit dem Rahmen bündig sind.

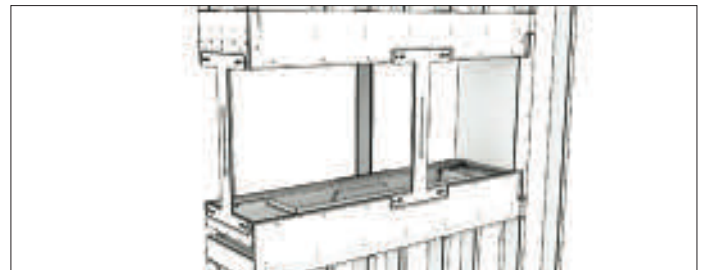

5. Richten Sie die Flanschverlängerungsplatte an den Gewindebohrungen am Gerät aus. Schrauben Sie es mit den mitgelieferten Schrauben fest (untere Reihe am Gerät, obere Reihe am Rahmenmaterial).

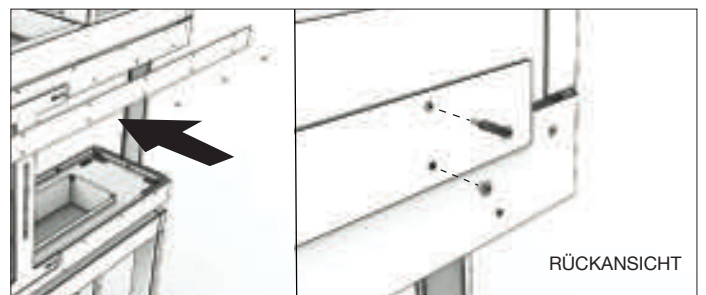

Peninsula Installation

6. Befestigen Sie das Gerät mit den vorhandenen Montagelöchern an den Geräteflanschen mit Schrauben am Rahmen. Stellen Sie sicher, dass das Gerät waagrecht steht, bevor Sie es befestigen.

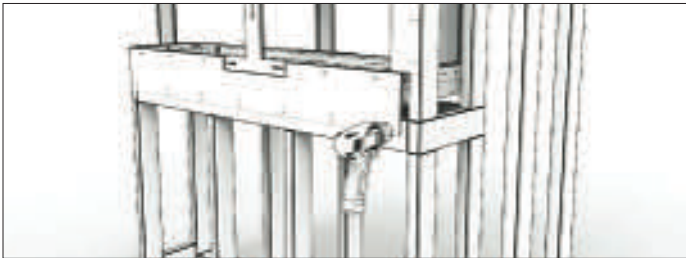

7. Entfernen Sie die roten Stabilisierungsbügel.



8. Schließen Sie die Konstruktion ab, indem Sie die Wandverkleidung um das Gerät herum fertigstellen. (Siehe Abschnitt **"EINBAU ANWEISUNGEN"**) und vergewissern Sie sich, dass Sie genau wissen, wo nicht brennbare Materialien verwendet werden müssen.



9. Setzen Sie den Brenner in Firebox ein.

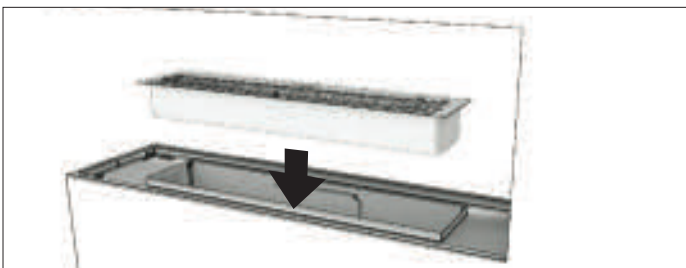

10. Entfernen Sie den Staubschutz, welches die Montageschlitz für Windschutzscheibe abdeckt.

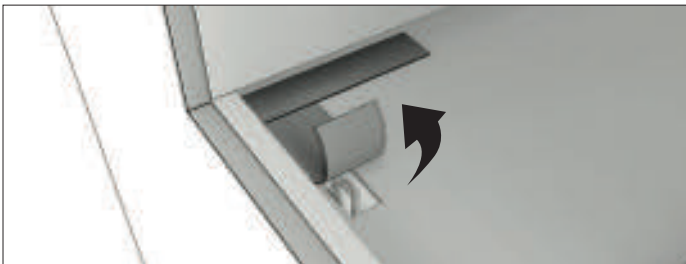

11. Wenn Ihr Gerät links / rechts oder in beiden Fällen mit einer dekorativen Box ausgestattet ist, setzen Sie die Glasscheibe/n ein, indem Sie das Glas nach oben in den Schlitz einführen und dann nach unten in die positionierten Clips drücken.

** Dekorative Holzscheite dürfen NICHT direkt über einer offenen Flamme platziert werden. Sie sind so konzipiert, dass sie in der Nähe von Hitze positioniert werden, jedoch nicht direkt über Flammen.*

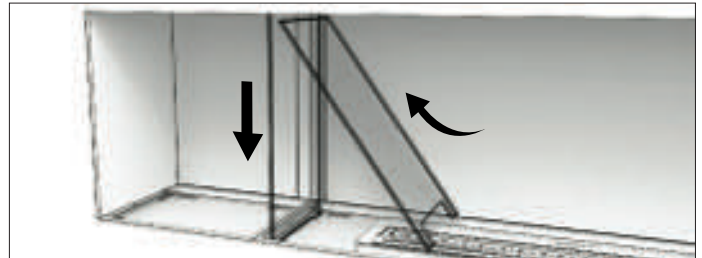

12. Setzen Sie die Glasscheibe in voller Höhe in die offene Stirnseite ein, indem Sie das Glas in die Öffnung oben am Gerät einsetzen und in die Schlitz in der Basis absenken, bis es einrastet.

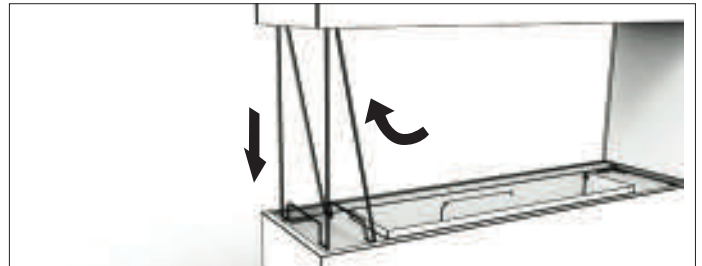

13. Installieren Sie die Windschutzscheibe, indem Sie die beiden Enden in die entsprechenden Schlitz des Geräts einführen. Drücken Sie die Windschutzscheibe mit etwas Druck in Position, bis sie in die verborgenen Glasclips einrastet.

WARNUNG: Das verwendete Glas ist gehärtetes Glas - das heißt, es ist stärker als normales Glas. Obwohl es stärker ist, weist gehärtetes Glas immer noch Schwächen auf. Die Ecken und Seiten sind spezifische Druckpunkte, an denen es anfälliger ist und bei Nichtbeachtung brechen kann. Gehärtetes Glas bricht in viele kleine Stücke. Achten Sie darauf, sich nicht an dem Glas zu schneiden. Wir empfehlen Ihnen, beim Umgang mit Glas Schutzhandschuhe zu tragen.

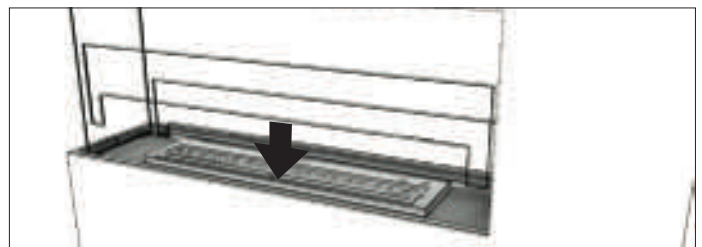

14. Verteilen Sie die Glaskohle gleichmäßig um die Gerätewanne. **ACHTUNG:** Stellen Sie sicher, dass der Brennerdeckel geschlossen ist. Halten Sie die Glaskohle vom Brennerflansch fern, damit die Glaskohle nicht versehentlich in die Brennkammer gelangt. Achten Sie darauf, den Brenner nicht zu zerkratzen.

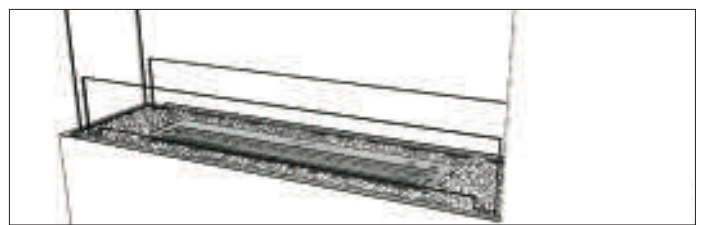

Island Installation

Erforderliche Ausrüstung: Bohrmaschine, Schraubendreher, Wasserwaage, Handspachtel für Gips, Silikonpistole

1. Konstruieren Sie das Gestell mit der Öffnungsgröße wie in Abbildung F dargestellt.. Die Basis des Rahmens kann aus einer festen Bank / Plattform bestehen, die das Aufrichten des Geräts in Position unterstützt.

WARNUNG: Dieses vierseitige Gerät kann nicht in eine Wandkonstruktion eingefügt werden. Es muss auf einem extra Gestell sicher mit dem Fußboden verankert werden. Auf keinen Fall auf beweglichen oder schwachen Strukturen installieren. Der Oberteil des Gerätes sollte auf einem Gestell installiert werden, welches an der Decke befestigt ist und außerdem auf den Grundrahmen ausgerichtet werden. Vierseitige Geräte sind als Trennwandeneinsätze konzipiert. Wenn Sie diese Installationsanweisung nicht einhalten, kann sich die Wand überhitzen und Feuer fangen.



Tabelle F: Rahmenöffnungsgrößen

Die Abmessungen der Firebox sollten vor dem Zuschneiden anhand der ausgeschnittenen Abmessungen überprüft werden, bevor die Installation beginnt, um die Toleranzen zu bestätigen.

FIREBOX	B mm [in]	T mm [in]	H mm [in]	Gewicht* kg [lbs]
FLEX18IL	455 [17.9]	349 [13.6]	730 [28.7]	22.2 [48.9]
FLEX32IL	887 [34.9]	349 [13.6]	730 [28.7]	33.5 [73.7]
FLEX42IL	1142 [45]	349 [13.6]	730 [28.7]	49.8 [109.6]
FLEX50IL	1347 [53]	349 [13.6]	730 [28.7]	59.9 [131.8]
FLEX50IL.BX	1347 [53]	349 [13.6]	730 [28.7]	48.3 [106.3]
FLEX60IL.BX	1602 [63.1]	349 [13.6]	730 [28.7]	64.6 [142.2]
FLEX68IL	1807 [71.1]	349 [13.6]	730 [28.7]	75.2 [165.5]
FLEX68IL.BX	1807 [71.1]	349 [13.6]	730 [28.7]	74.7 [164.4]
FLEX68IL.BX2	1807 [71.1]	349 [13.6]	730 [28.7]	63.1 [138.9]
FLEX78IL.BX2	2062 [81.2]	349 [13.6]	730 [28.7]	79.4 [174.8]
FLEX86IL	2267 [89.3]	349 [13.6]	730 [28.7]	101.5 [223.2]
FLEX86IL.BX	2267 [89.3]	349 [13.6]	730 [28.7]	90 [198.1]
FLEX86IL.BX2	2267 [89.3]	349 [13.6]	730 [28.7]	89.5 [197]
FLEX104IL	2727 [107.4]	349 [13.6]	730 [28.7]	116.3 [255.9]
FLEX104IL.BX	2727 [107.4]	349 [13.6]	730 [28.7]	116.3 [255.9]
FLEX104IL.BX2	2727 [107.4]	349 [13.6]	730 [28.7]	104.8 [230.6]
FLEX122IL	3187 [125.5]	349 [13.6]	730 [28.7]	148.6 [327]
FLEX122IL.BX	3187 [125.5]	349 [13.6]	730 [28.7]	131.1 [288.4]
FLEX122IL.BX2	3187 [125.5]	349 [13.6]	730 [28.7]	131.1 [288.4]
FLEX140IL.BX	3647 [143.6]	349 [13.6]	730 [28.7]	163.4 [359.6]
FLEX140IL.BX2	3647 [143.6]	349 [13.6]	730 [28.7]	145.9 [321.1]
FLEX158IL	4107 [161.7]	349 [13.6]	730 [28.7]	173.9 [382.6]
FLEX158IL.BX2	4107 [161.7]	349 [13.6]	730 [28.7]	178.3 [392.2]

Das Gerätegewicht umfasst Brenner / s (Trockengewicht ohne Brennstoff), Glaskohle und Glas. Es enthält NICHT das Gewicht der Glaskohle für die Seitenkästen.

WICHTIG: Der Rahmen über dem Gerät muss selbsttragend sein. Das Gerät ist nicht selbsttragend.

2. Entfernen Sie den Verlängerungsflansch von der Firebox, so dass beide Seiten die gleiche Höhe haben. Dies erleichtert das Einschleiben der Firebox in den Rahmen. Achten Sie darauf, die Schrauben nicht zu verlieren. Sie werden erneut benötigt, wenn der Flansch wieder montiert wird.

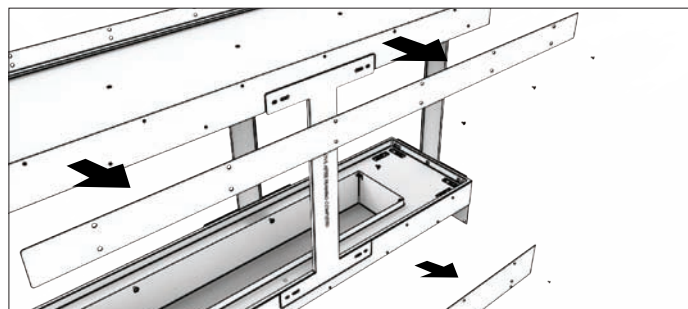

3. Schieben Sie die Firebox in den Rahmen (die Unterseite des Geräts kann direkt auf dem Rahmenmaterial sitzen). Die Firebox wird mit roten Stabilisierungsbügeln geliefert, die an der/den offenen Seite/n angebracht sind, um das Gerät während des Transports und während der Installation rechteckig zu halten. Entfernen Sie die Stabilisierungsbügel erst nach dem Einbau in den Rahmen, dies hilft die Firebox während des Einbaus rechteckig zu halten.

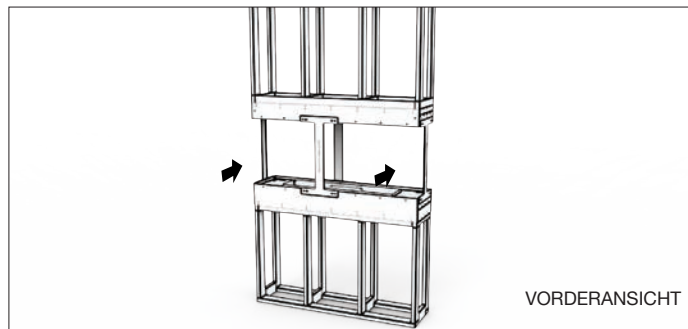

4. Richten Sie die Flanschverlängerungsplatte an den Gewindebohrungen am Gerät aus. Schrauben Sie es mit den mitgelieferten Schrauben fest (untere Reihe am Gerät, obere Reihe am Rahmenmaterial).

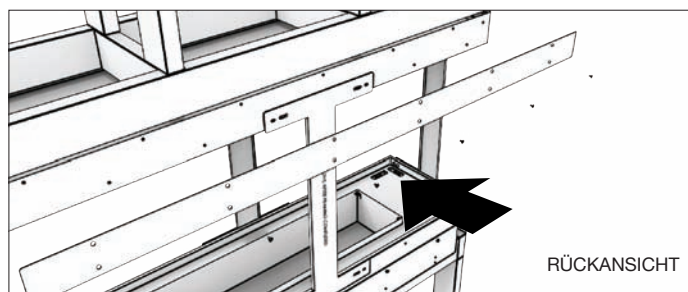

5. Befestigen Sie das Gerät mit den vorhandenen Montagelöchern an den Geräteflanschen mit Schrauben am Rahmen. Stellen Sie sicher, dass das Gerät waagrecht steht, bevor Sie es befestigen.

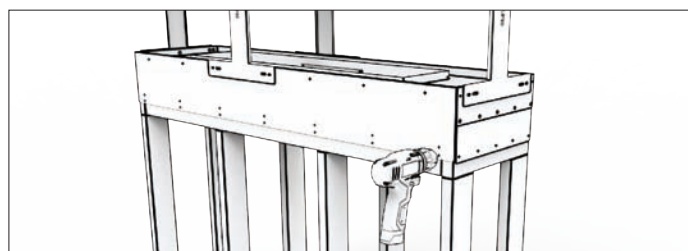

6. Entfernen Sie die roten Stabilisierungsbügel.

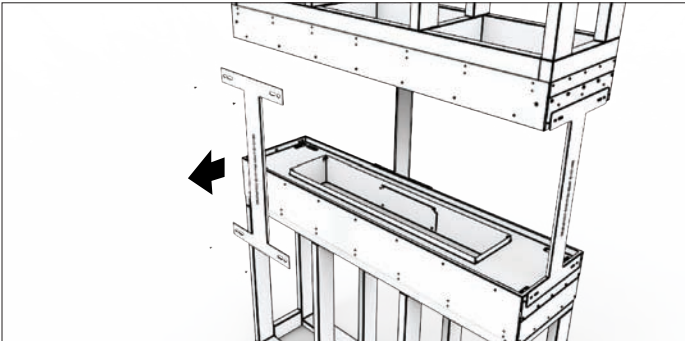

7. Schließen Sie die Konstruktion ab, indem Sie die Wandverkleidung um das Gerät herum fertigstellen. (Siehe Abschnitt **“EINBAU ANWEISUNGEN”**) und vergewissern Sie sich, dass Sie genau wissen, wo nicht brennbare Materialien verwendet werden müssen.

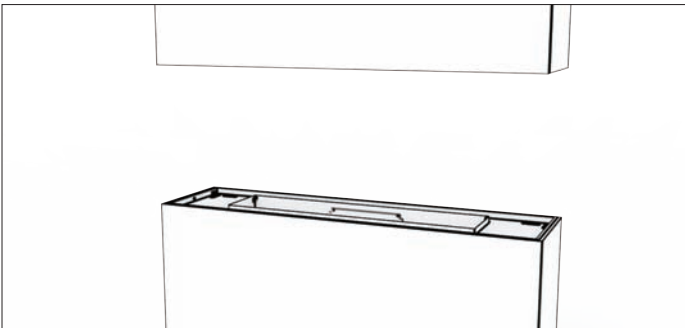

8. Setzen Sie den Brenner in Firebox ein.

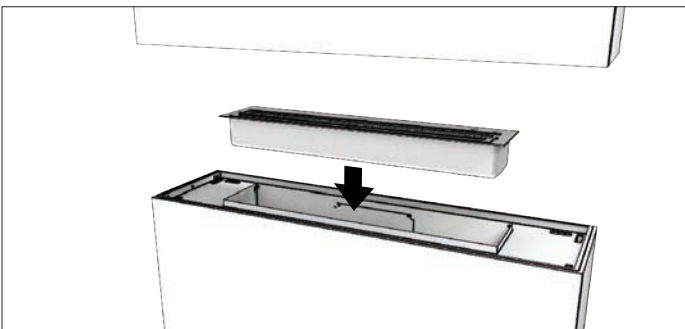

9. Entfernen Sie den Staubschutz, welches die Montageschlitz für Windschutzscheibe abdeckt.

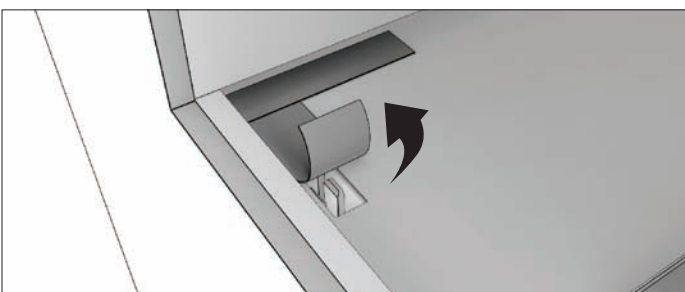

10. Installieren Sie die Windschutzscheibe, indem Sie die beiden Enden in die entsprechenden Schlitz des Geräts einführen. Drücken Sie die Windschutzscheibe mit etwas Druck in Position, bis sie in die verborgenen Glasclips einrastet. Wiederholen Sie dasselbe Prozedere für die Hinterseite und sollte Ihr Gerät über eine dekorative Box verfügen, auch links/rechts oder beidseitig.

** Dekorative Holzscheite dürfen NICHT direkt über einer offenen Flamme platziert werden. Sie sind so konzipiert, dass sie in der Nähe von Hitze positioniert werden, jedoch nicht direkt über Flammen. Fügen Sie diesem Modell nur ein Set an dekorativen Balken hinzu.*

WARNUNG: Das verwendete Glas ist gehärtetes Glas - das heißt, es ist stärker als normales Glas. Obwohl es stärker ist, weist gehärtetes Glas immer noch Schwächen auf. Die Ecken und Seiten sind spezifische Druckpunkte, an denen es anfälliger ist und bei Nichtbeachtung brechen kann. Gehärtetes Glas bricht in viele kleine Stücke. Achten Sie darauf, sich nicht an dem Glas zu schneiden. Wir empfehlen Ihnen, beim Umgang mit Glas Schutzhandschuhe zu tragen.

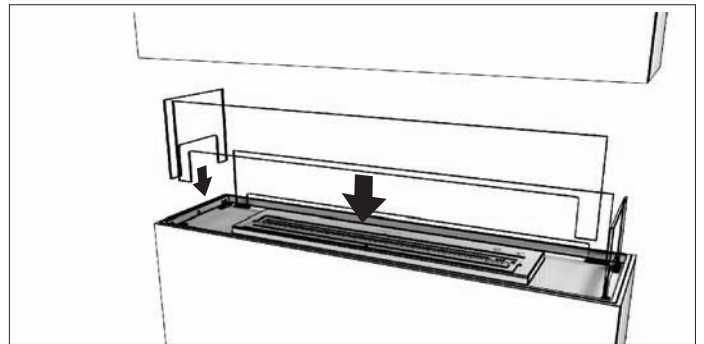

11. Verteilen Sie die Glaskohle gleichmäßig um die Geräterwanne. **ACHTUNG:** Stellen Sie sicher, dass der Brennerdeckel geschlossen ist. Halten Sie die Glaskohle vom Brennerflansch fern, damit die Glaskohle nicht versehentlich in die Brennkammer gelangt. Achten Sie darauf, den Brenner nicht zu zerkratzen.

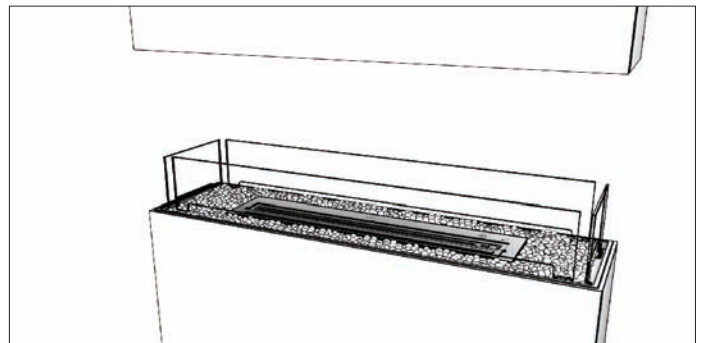

Bench Installation

Erforderliche Ausrüstung: Bohrmaschine, Schraubendreher, Wasserwaage, Handspachtel für Gips, Silikonpistole

1. Konstruieren Sie das Hauptgestell mit den Abmessungen wie in Abbildung G angegeben. Die Basis des Rahmens kann aus einer festen Bank / Plattform bestehen, die das Aufrichten des Geräts in Position unterstützt. Beim Planen der Konstruktion stellen Sie bitte sicher, dass zwischen Brenneröffnung und Decke ein Minimum an 1500 mm (59.1") Überkopfhöhe freigelassen wird.

WARNUNG: Dieses vierseitige Gerät kann nicht in eine Wandkonstruktion eingefügt werden. Es muss auf einem extra Gestell sicher mit dem Fußboden verankert werden. Auf keinen Fall auf beweglichen oder schwachen Strukturen installieren. Vierseitige Geräte sind als Trennwandensätze konzipiert. Wenn Sie diese Installationsanweisung nicht einhalten, kann sich die Wand überhitzen und Feuer fangen.



Tabelle G: Gestellgrößen

Die Abmessungen der Firebox sollten vor dem Zuschneiden anhand der ausgeschnittenen Abmessungen überprüft werden, bevor die Installation beginnt, um die Toleranzen zu bestätigen.

FIREBOX	B mm [in]	T mm [in]	Gewicht* kg [lbs]
FLEX18BN	455 [17.9]	349 [13.6]	18.3 [40.2]
FLEX32BN	887 [34.9]	349 [13.6]	27.5 [60.6]
FLEX42BN	1142 [45]	349 [13.6]	33.8 [74.4]
FLEX50BN	1347 [53]	349 [13.6]	39.5 [86.9]
FLEX50BN.BX	1347 [53]	349 [13.6]	38.4 [84.5]
FLEX60BN.BX	1602 [63.1]	349 [13.6]	44.7 [98.4]
FLEX68BN	1807 [71.1]	349 [13.6]	50.3 [110.6]
FLEX68BN.BX	1807 [71.1]	349 [13.6]	61.1 [134.5]
FLEX68BN.BX2	1807 [71.1]	349 [13.6]	49.3 [108.5]
FLEX78BN.BX2	2062 [81.2]	349 [13.6]	55.6 [122.4]
FLEX86BN	2267 [89.3]	349 [13.6]	71.6 [157.5]
FLEX86BN.BX	2267 [89.3]	349 [13.6]	61.1 [134.5]
FLEX86BN.BX2	2267 [89.3]	349 [13.6]	61.3 [134.8]
FLEX104BN	2727 [107.4]	349 [13.6]	80 [176]
FLEX104BN.BX	2727 [107.4]	349 [13.6]	82.5 [181.5]
FLEX104BN.BX2	2727 [107.4]	349 [13.6]	72 [158.5]
FLEX122BN	3187 [125.5]	349 [13.6]	105.6 [232.4]
FLEX122BN.BX	3187 [125.5]	349 [13.6]	90.9 [200]
FLEX122BN.BX2	3187 [125.5]	349 [13.6]	93.4 [205.5]
FLEX140BN.BX	3647 [143.6]	349 [13.6]	116.5 [256.3]
FLEX140BN.BX2	3647 [143.6]	349 [13.6]	101.8 [224]
FLEX158BN	4107 [161.7]	349 [13.6]	118.8 [261.4]
FLEX158BN.BX2	4107 [161.7]	349 [13.6]	127.4 [280.3]

Das Gerätegewicht umfasst Brenner / s (Trockengewicht ohne Brennstoff), Glaskohle und Glas. Es enthält NICHT das Gewicht der Glaskohle für die Seitenkästen.

2. Entfernen Sie den Verlängerungsflansch von der Firebox, so dass beide Seiten die gleiche Höhe haben. Dies erleichtert das Einschleiben der Firebox in den Rahmen. Achten Sie darauf, die Schrauben nicht zu verlieren. Sie werden erneut benötigt, wenn der Flansch wieder montiert wird.

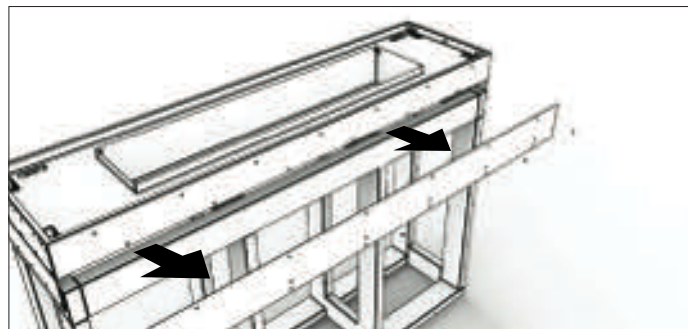

3. Schieben Sie die Firebox in den Rahmen (die Unterseite des Geräts kann direkt auf dem Rahmenmaterial sitzen).

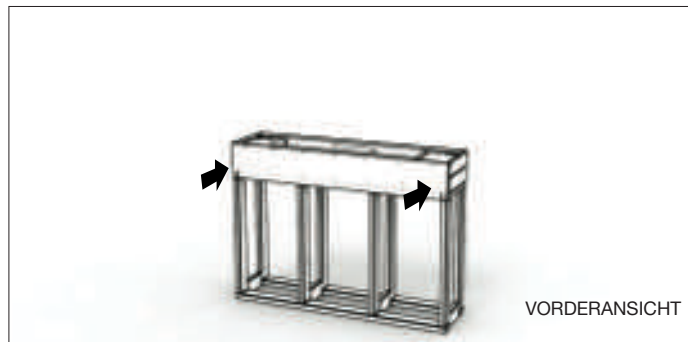

4. Richten Sie die Flanschverlängerungsplatte an den Gewindebohrungen am Gerät aus. Schrauben Sie es mit den mitgelieferten Schrauben fest (untere Reihe am Gerät, obere Reihe am Rahmenmaterial).

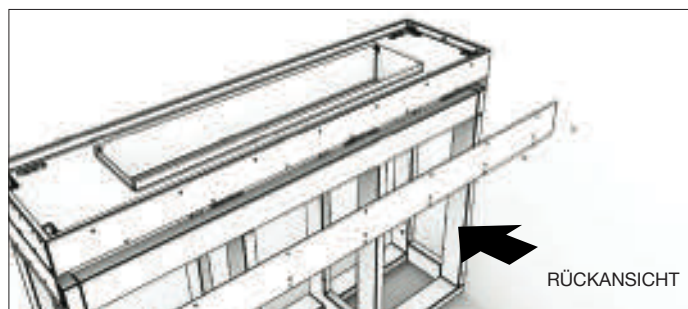

5. Befestigen Sie das Gerät mit den vorhandenen Montagelöchern an den Geräteflanschen mit Schrauben am Rahmen. Stellen Sie sicher, dass das Gerät waagrecht steht, bevor Sie es befestigen.



Bench Installation

6. Schließen Sie die Konstruktion ab, indem Sie die Wandverkleidung um das Gerät herum fertigstellen. (Siehe Abschnitt **“EINBAU ANWEISUNGEN”**) und vergewissern Sie sich, dass Sie genau wissen, wo nicht brennbare Materialien verwendet werden müssen.



7. Setzen Sie den Brenner in Firebox ein.

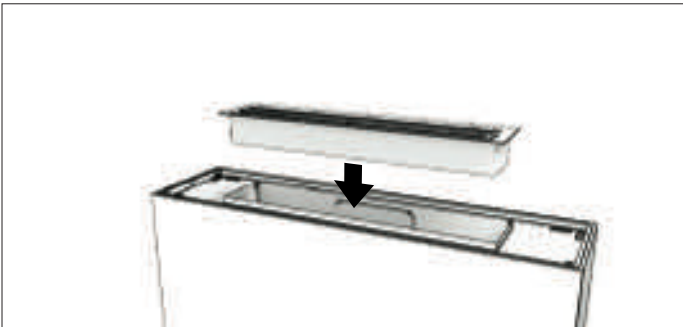

8. Entfernen Sie den Staubschutz, welches die Montageschlitz für Windschutzscheibe abdeckt.

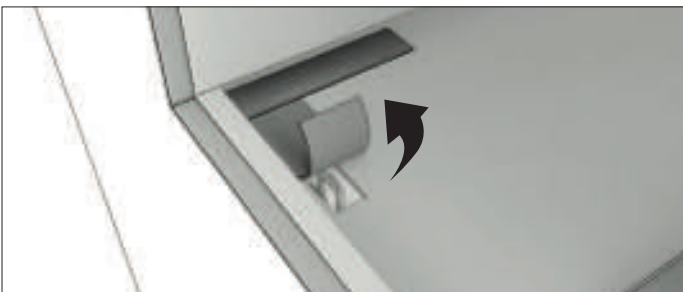

9. Installieren Sie die Windschutzscheibe, indem Sie die beiden Enden in die entsprechenden Schlitze des Geräts einführen. Drücken Sie die Windschutzscheibe mit etwas Druck in Position, bis sie in die verborgenen Glasclips einrastet. Wiederholen Sie dasselbe Prozedere für die Hinterseite und sollte Ihr Gerät über eine dekorative Box verfügen, auch links/rechts oder beidseitig.

** Dekorative Holzscheite dürfen NICHT direkt über einer offenen Flamme platziert werden. Sie sind so konzipiert, dass sie in der Nähe von Hitze positioniert werden, jedoch nicht direkt über Flammen. Fügen Sie diesem Modell nur ein Set an dekorativen Balken hinzu.*

WARNUNG: Das verwendete Glas ist gehärtetes Glas - das heißt, es ist stärker als normales Glas. Obwohl es stärker ist, weist gehärtetes Glas immer noch Schwächen auf. Die Ecken und Seiten sind spezifische Druckpunkte, an denen es anfälliger ist und bei Nichtbeachtung brechen kann. Gehärtetes Glas bricht in viele kleine Stücke. Achten Sie darauf, sich nicht an dem Glas zu schneiden. Wir empfehlen Ihnen, beim Umgang mit Glas Schutzhandschuhe zu tragen.

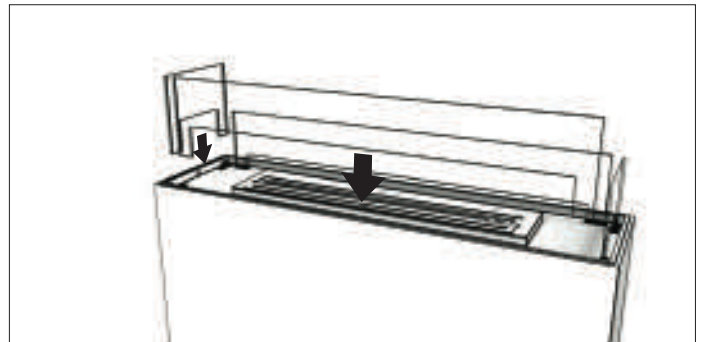

10. Verteilen Sie die Glaskohle gleichmäßig um die Gerätewanne. **ACHTUNG:** Stellen Sie sicher, dass der Brennerdeckel geschlossen ist. Halten Sie die Glaskohle vom Brennerflansch fern, damit die Glaskohle nicht versehentlich in die Brennkammer gelangt. Achten Sie darauf, den Brenner nicht zu zerkratzen.

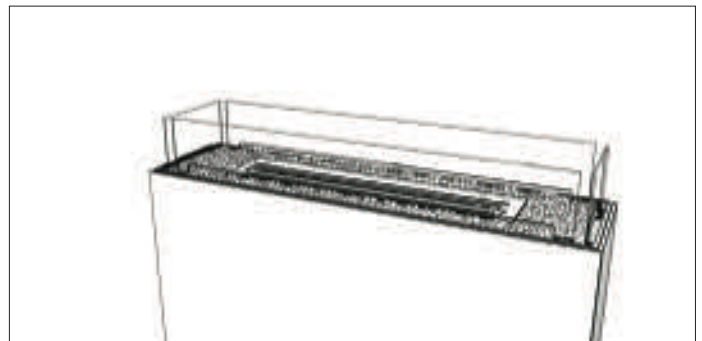

1. Installieren sie die umgebenden Wandpaneele. Geeignete Materialien hierfür sind Faserzementplatten, brandsichere Faserplatten mittlerer Dichte (FR MDF), Stein, Fliesen, Stahl und brandsicherer (FR) Gipskarton.

Verkleidungs- oder Veredelungsmaterialien dürfen niemals in die Geräteöffnung hineinragen.

WARNUNG! Brandgefahr! Verwenden Sie keine brennbaren Materialien außerhalb der Mindestabstände. Beachten Sie alle Mindestabstände zu brennbaren Stoffen, wie in dieser Anleitung und der Brenneranleitung beschrieben.

WICHTIG: Über allen Seiten der Geräteöffnungen muss eine nicht brennbare Platte (155 mm) installiert werden. Sehen Beispiele unten.



Beispiel: Einseitig geöffneter Kamin



Beispiel: Model „Peninsula“

2. An allen Kanten MUSS eine Metallleiste angebracht werden (mit Gehrungskante). (Verwenden Sie keine langen Befestigungsmittel, die dicker als das Wandverkleidungsmaterial sind, um ein Eindringen in das Gerät zu vermeiden.)

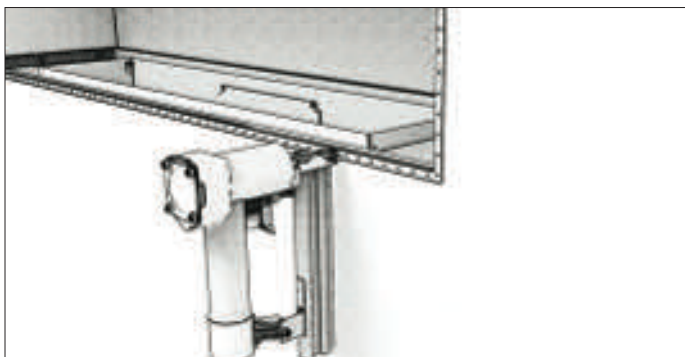

3. Verputzen Sie alle Fugen und Nahtstellen.

Alle Verbindungen zwischen dem fertigen Wandmantel und der Vorderseite des Geräts müssen mit nicht brennbaren Materialien abgedichtet sein. Dichtungsmittel die zum Abdichten des Zwischenraums zwischen der Wand und dem Gerät verwendet werden, sollten für eine minimale Dauerbelastung von 150 ° C (122 ° F) ausgelegt werden.

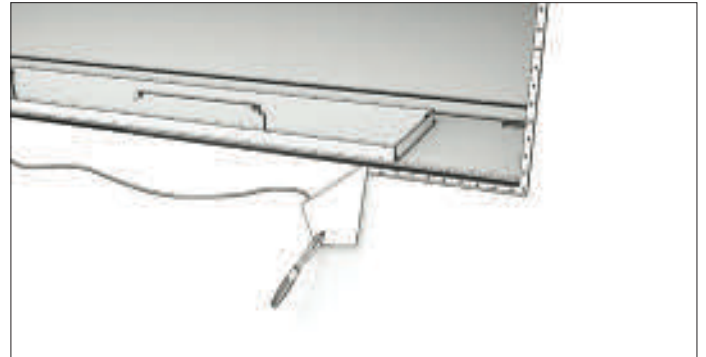

4. Wenn Sie die umgebende Wand streichen möchten, können 100% Acryl-Latex oder Öl oder Standard-Acryl Farben verwendet werden. Befolgen Sie die Anweisungen des Herstellers zum Auftragen von Farbe und Grundierung.

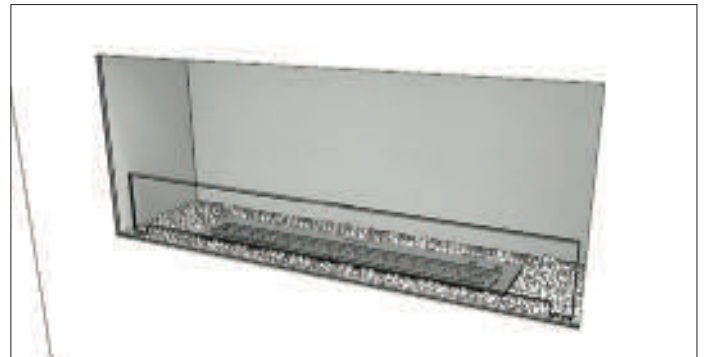

BEFOLGEN SIE DIE BETRIEBSANLEITUNG , DIE DEM BRENNER BEIGEFÜGT IST.

Mindestabstände

Wenn die Installation einen Kaminsims oder eine andere Einfassung enthält, müssen die vertikalen und maximalen horizontalen Abstände für brennbare Materialien wie in der Abbildung unten angegeben beachtet werden.

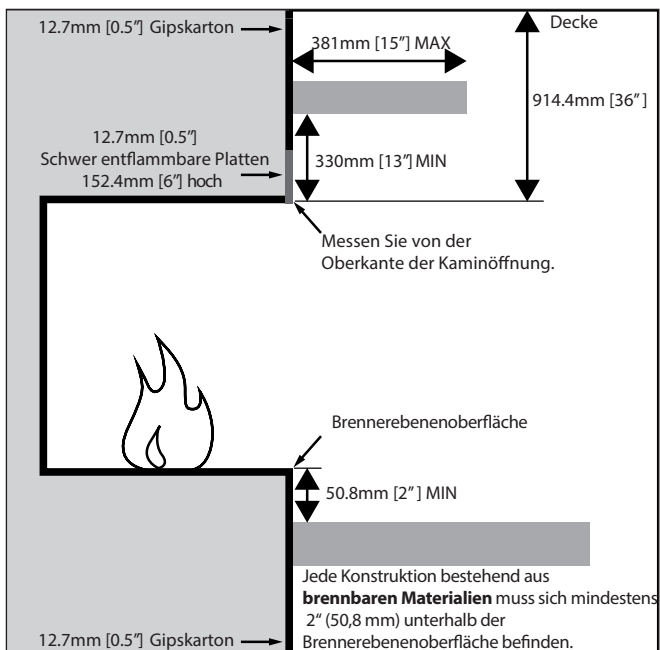
Mindestabstände zu BRENNBAREN MATERIALIEN

Minimale vertikale und maximale horizontale Abmessungen zum brennbaren Kaminsims.

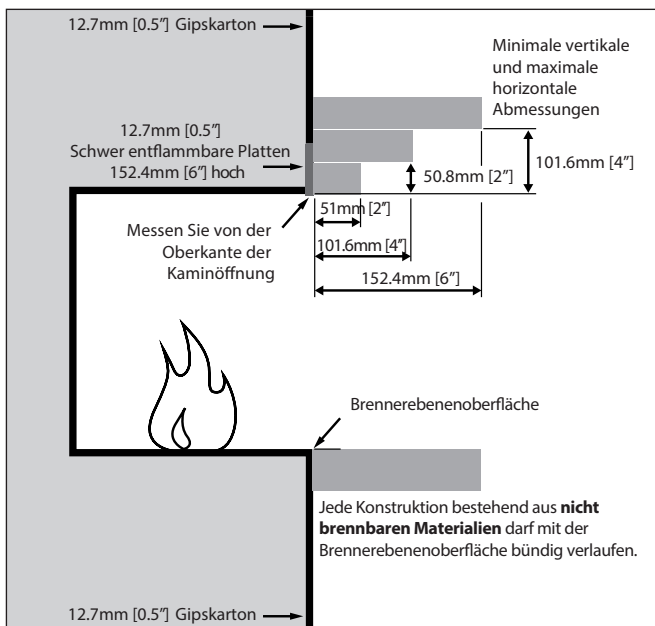
Einbau und Sicherheitsabstände zu NICHT BRENNBAREN MATERIALIEN

Warnung! Brandgefahr! Beachten Sie alle Mindestabstände zu brennbaren Stoffen wie angegeben.

Einrahmungs- oder Veredelungsmaterial die näher als der angegebene Minimumabstand eingebaut werden müssen komplett aus nicht brennbaren Materialien bestehen.

Bei Geräten mit dekorativer Seitenkiste wird eine Füllplatte bereitgestellt, um das Material an der Unterkante des Geräts auszurichten. Dekorationsboxen dürfen nur für nicht brennbare Zubehörteile / Materialien verwendet werden.

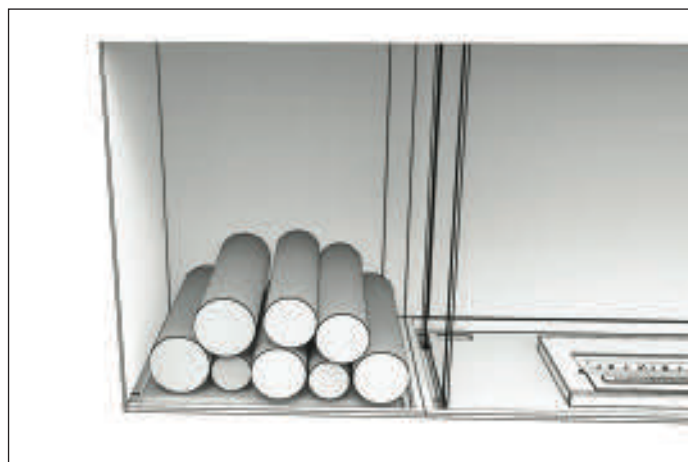
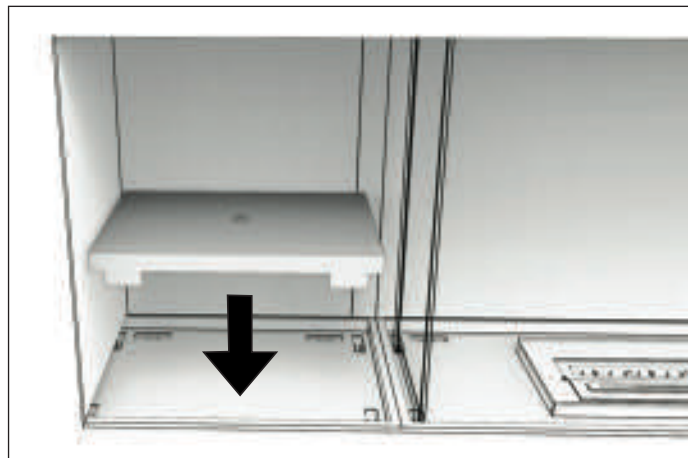

Dekorative Stahlblöcke sind als optionales Zubehör erhältlich. Bitte wenden Sie sich an customerservice@ecosmartfire.com

* Dekorative Holzscheite dürfen NICHT direkt über einer offenen Flamme platziert werden. Sie sind so konzipiert, dass sie in der Nähe von Hitze positioniert werden, jedoch nicht direkt über Flammen.

Dégagements de l'insert

CHOISIR L'EMPLACEMENT' DE L'APPLICATION	42
VENTILATION	42
TAILLE MINIMALE DE LA PIECE	42

Installation de l'insert

ENCADREMENT	43
AVANT DE COMMENCER	44
INSTALLATION SIMPLE FACE	45 - 46
INSTALLATION CÔTÉ GAUCHE	47 - 48
INSTALLATION CÔTÉ DROIT	47 - 48
INSTALLATION BAIE	49 - 50
INSTALLATION DOUBLE FACE	51 - 52
INSTALLATION PENINSULE	53 - 54
INSTALLATION ILE	55 - 56
INSTALLATION BANC	57 - 58
FINITIONS	59
TABLETTE DE CHEMINEE	60
DECORATIVE BOX INFILL PLATE	60

Ces inserts sont approuvés par le fabricant et doivent être utilisés uniquement avec les brûleurs listés UL.

OPERATION

Veillez vous référer au manuel d'opération fournis avec le Brûleur.

Dégagements de l'insert

Veillez lire ces instructions dans leur intégralité avant d'utiliser votre produit EcoSmart™ Fire.

CHOISIR L'EMPLACEMENT DE L'APPLICATION

Les foyers sont préfabriqués zéro-dégagement et peuvent être encadrés par des matériaux combustibles. Ils sont conçus pour accueillir uniquement des brûleurs EcoSmart Fire.

Afin de choisir l'emplacement de l'insert, il est important de considérer la taille minimale de la pièce ainsi que les distances entre le produit et le mur et les matériaux combustibles (Veillez vous référer aux images des dégagements et au tableau des dimensions minimales des pièces)

Remarque: Les modèles FLEX sont construits à base d'acier zingué avec une couche de peinture noire résistante aux hautes températures empêchant le matériel de rouiller. Les brûleurs sont fabriqués à base d'acier inoxydable 304. Afin de s'assurer que les brûleurs restent en bonne condition et afin d'éviter toute rouille et corrosion, il est important d'enlever immédiatement les débris et contaminants sur le brûleur.

Si le produit est installé à l'extérieur, il faut le placer sous un espace couvert pour éviter que l'eau s'infilte à l'intérieur et l'endommage. Le produit ne sera pas pris en charge par la garantie si placé dans un espace découvert.

Lorsque non utilisé, veuillez laisser le couvercle sur le brûleur afin de le protéger des débris éventuels pouvant tomber dans le réservoir du brûleur et provoquer ainsi une contamination.

ATTENTION: Risque d'incendie ou de brûlures! Prévoyez un dégagement adéquat autour des ouvertures d'air et pour un accès facile. Prenez note des dégagements des matériaux combustibles les plus proches tels que recommandés dans ce manuel et celui du brûleur. Assurez-vous que votre produit soit positionné loin des **matériaux inflammables et d'autres sources d'inflammation.** En raison de température élevées, l'insert FLEX doit être situé hors du chemin et à l'écart des meubles ou rideaux. Faites très attention à positionner le feu loin d'objets susceptibles de bouger en raison du vent ou autres courants d'air; par exemple, les arbres / branches/ rideaux / papiers, etc. Gardez toujours les enfants à une distance de sécurité et ne les laissez jamais sans surveillance lorsque l'insert est en fonctionnement ou chaud.

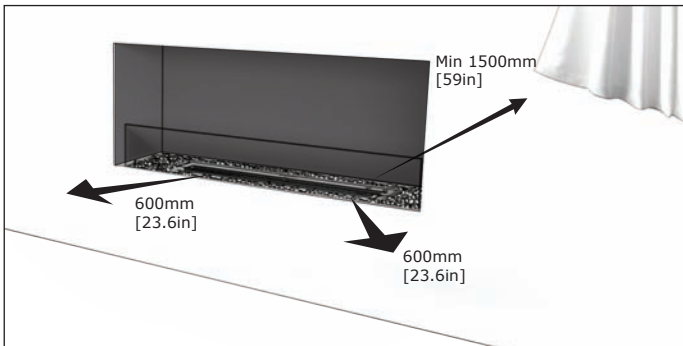

Dégagements Intérieurs

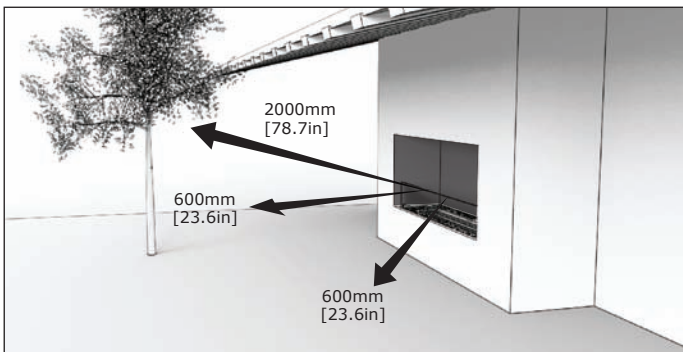

Dégagements Extérieurs (Il faut un surplomb ou une "extension de toit" au-dessus du foyer pour empêcher la pluie y pénétrer. Consultez les codes du bâtiment locaux en ce qui concerne les exigences relatives aux surplombs / extensions de toit.)

VENTILATION

Les cheminées EcoSmart ne nécessitent aucune forme de fixation ou installation permanente ou, tel qu'un conduit de ventilation, une connexion permanente quelle qu'elle soit ou toute sorte de connexion à une source d'alimentation en combustible.

Ne pas couvrir les systèmes ou structures de ventilation préexistants dans l'espace sélectionné pour l'installation.

Pour s'assurer d'une ventilation adéquate, assurez-vous de suivre les instructions indiquées dans le tableau.

Underwriters Laboratories (UL) calcule ainsi l'échange d'air adéquat:

Dans une bâtisse de construction classique, c'est-à-dire une construction qui n'est pas totalement hermétique grâce à une importante isolation et des joints garantis 100% contre les infiltrations d'air, l'apport d'air qui est nécessaire pour la combustion et la ventilation se fait par infiltration. Toutefois, si le chauffage est utilisé dans une petite pièce (ex. moins de 5.7m³ de volume d'air fourni pour chaque 1000 Btu/ heure de chaleur – réglé sur le réglage le plus fort de l'insert), la/ les porte(s) adjacente(s) à cette pièce doivent rester ouvertes, ou une fenêtre donnant sur l'extérieur doit être entrouverte au minimum de 25.4mm pour éviter une accumulation potentielle d'air saturé de CO₂ à l'intérieur de la pièce. Ne pas installer, ni faire fonctionner l'insert dans une salle de bain ou toute pièce qui serait de petites dimensions.

TAILLE MINIMALE DE LA PIÈCE

Table de ventilation basée sur le nombre de brûleurs (par produit).

Insert	Brûleur(s)	Taille minimale de la pièce	BTU
FLEX18	1x AB3	1413 Pieds cubes (40 mètres cubes)	5,800
FLEX32 FLEX50.BX FLEX68.BX2	1x XL500	2825 Pieds cubes (80 mètres cubes)	11,430
FLEX42 FLEX60.BX FLEX78.BX2	1x XL700	3178 Pieds cubes (90 mètres cubes)	13,650
FLEX50 FLEX68.BX FLEX86.BX2	1x XL900	3884 Pieds cubes (110 mètres cubes)	15,000
FLEX68 FLEX86.BX FLEX104.BX2	1x XL1200	4061 Pieds cubes (115 mètres cubes)	16,200
FLEX86 FLEX104.BX FLEX122.BX2	2x XL900	7768 Pieds cubes (220 mètres cubes)	30,000
FLEX104 FLEX122.BX FLEX140.BX2	2x XL1200	8122 Pieds cubes (230 mètres cubes)	32,400
FLEX122 FLEX140.BX FLEX158.BX2	3x XL900	11652 Pieds cubes (330.2 mètres cubes)	45,000
FLEX158	3x XL1200	12183 Pieds cubes (345 mètres cubes)	48,600

N'EST GÉNÉRALEMENT PAS UTILISÉ COMME SOURCE DE CHALEUR PRIMAIRE.

Ce produit a été testé et approuvé comme source de chaleur supplémentaire ou en tant qu'élément décoratif. Il ne doit pas être utilisé comme source de chaleur principale dans les calculs de chauffage résidentiels.

Installation de l'insert

Ces inserts doivent être installés dans une position sécurisée avant d'être utilisés.

REMARQUE: NE PAS INSTALLER DIRECTEMENT CONTRE OU À PROXIMITÉ DE PAPIER PEINT, SURFACE MÉLAMINÉE, OU DE TOUTE SURFACE QUI N'A PAS ÉTÉ CERTIFIÉE POUR UNE UTILISATION À PROXIMITÉ D'UN FOYER (la chaleur pourrait endommager les matériaux et dans certains cas affecter la colle utilisée pour fixer l'insert). **LORSQUE L'INSERT EST EN FONCTIONNEMENT, LA ZONE AUTOUR DU MODÈLE DEVIENT CHAUDE – TOUT MATÉRIAU SENSIBLE OU RÉACTIF À LA CHALEUR NE DEVRAIT PAS ÊTRE UTILISÉ. NE PAS PLACER D'OBJECTS INFLAMMABLES SUR OU AUTOUR DU DISPOSITIF.**

Les inserts de cheminée ne sont pas conçus pour incorporer de porte ou couvercle (sauf si spécifiquement pourvu(e) par MAD Design Group). Le foyer doit rester ouvert en permanence pour la ventilation, il n'est pas conçu pour être utilisé comme four ou tout autre équipement de chauffage non prévu à cet effet; la flamme doit être en permanence au contact de l'air pour pouvoir fonctionner, pour que la chaleur circule et soit distribuée efficacement.

NE PAS BLOQUER OU REMPLIR CES ESPACES VIDES (entre le brûleur et les espaceurs) **AVEC DES MATÉRIAUX ISOLANTS OU TOUT AUTRE MATÉRIAU. CES VIDES D'AIR SONT NÉCESSAIRES À LA BONNE VENTILATION DU SYSTÈME.**

Évitez toute modification du produit pendant l'installation. Il est interdit de couper les pièces en métal du produit.

L'expansion et la contraction des composants internes dues au chauffage et au refroidissement peuvent générer du bruit, ce qui est normal.

ATTENTION: NE PAS UTILISER SANS LA VITRE DE PROTECTION

L'insert doit être entièrement assemblé avant son utilisation. Si le pare-feu n'est pas installé (ou est retiré) cela annulera toute garantie et le produit ne sera pas approuvé pour une utilisation avec le brûleur inclus.

ENCADREMENT

Considérations importantes pour le cadrage

1. L'insert doit être installé sur une surface plane pouvant supporter le produit, le brûleur, le verre anthracite et la pleine capacité de combustible.
2. Les dimensions d'encadrement indiquées dans les instructions correspondent aux dimensions optimales qui permettent un meilleur ajustement avec le gyproc / le rocher / la plaque de plâtre (ou tout autre matériau de revêtement / de finition) après l'installation de l'insert.
3. Préparez l'emplacement d'installation. Si vous placez l'insert sur une plate-forme, construisez-la en veillant à pouvoir supporter son poids, du brûleur, du verre anthracite et du combustible. Vérifiez que la plate-forme est de niveau.

En cas de capacité insuffisante pour supporter le poids de l'insert, des mesures doivent être prises pour renforcer le cadre (par exemple l'installation d'une plaque pour la distribution du poids) afin que le réglage soit adapté à l'installation

IMPORTANT: L'encadrement ci-dessus de l'insert doit être autoportant. L'insert n'est pas porteur de charge complémentaire.

DEFINITIONS

Matériaux combustibles - Les matériaux constitués de bois, de papier compressé, de fibres végétales, de plastique ou de tout autre matériau susceptible de s'enflammer et de brûler, qu'ils soient à la flamme ou plâtrés ou non, doivent être considérés comme des matières combustibles.

Matériaux non-combustibles - Les Matériaux qui ne s'enflamment pas et ne brûlent pas. De tels matériaux sont ceux consistant entièrement en acier, fer, brique, tuile, béton, ardoise, verre ou enduits, ou toute combinaison de ceux-ci. HardieBacker®, WonderBoard®, Durock® ou des matériaux dont la conformité à la norme ASTM E 136, Méthode d'essai standard pour le comportement des matériaux dans un four à tube vertical à 750 °C, doivent être considérés comme des matériaux non combustibles.

REMARQUE: Les illustrations représentent des installations typiques et sont destinées uniquement à des fins de conception. Les illustrations / schémas ne sont pas dessinés à échelle réelle. L'installation réelle peut varier en fonction des préférences de conception individuelles.

Installation de l'insert

AVANT DE COMMENCER

1. Retirez avec précaution l'insert de les composants de l'emballage
2. Inspectez et rapporter les pièces endommagées pendant le transport, en particulier l'état de la vitre de protection en verre.
3. Lisez toutes les instructions avant de commencer l'installation.
Suivez attentivement ces précautions d'emploi pendant l'installation pour assurer votre sécurité et celle de votre entourage.

ATTENTION: Risque d'incendie ou d'explosion! Les pièces endommagées peuvent compromettre un bon fonctionnement. Ne pas installer des éléments endommagés, incomplets ou remplacer par d'autres pièces détachées.

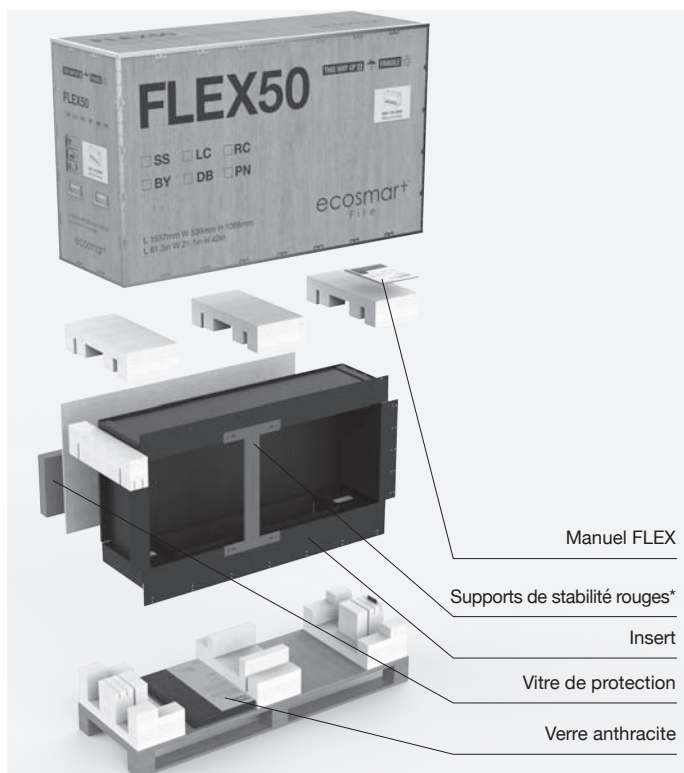

Caisse de l'insert

* Ne s'applique pas aux modèles Flex Bench.

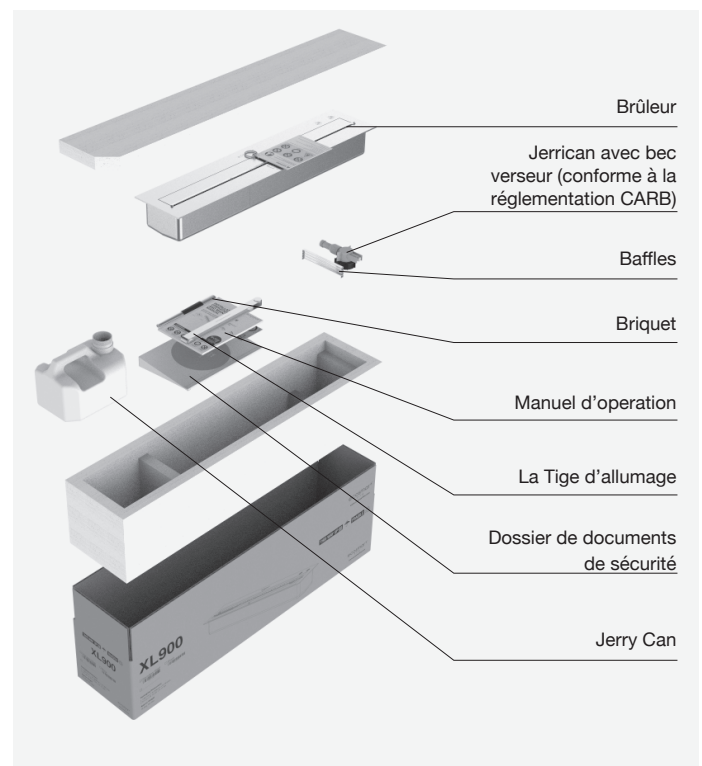

Carton du brûleur

Installation Simple Face

45

Matériel nécessaire: Perceuse, Tournevis, Truelle pour le plâtre, Pistolet à silicone, Pistolet à calfeutrer.

1. Construisez le cadre du mur principale avec la taille d'ouverture indiquée dans le tableau A. La base du cadre peut être un solide banc / plate-forme, ce qui facilitera la mise à niveau de l'insert lorsqu'il est en position.



Tableau A: Taille D'ouverture du Cadre

Les dimensions du modèle réel devraient être comparées avec les dimensions de la découpe AVANT l'installation finale afin de confirmer l'alignement parfait.

L'INSERT	L mm [in]	P mm [in]	H mm [in]	Poids* kg [lbs]
FLEX18SS	488 [19.2]	365 [14.4]	730 [28.7]	25.7 [56.5]
FLEX32SS	922 [36.3]	365 [14.4]	730 [28.7]	45.7 [100.5]
FLEX42SS	1177 [46.3]	365 [14.4]	730 [28.7]	60 [131.9]
FLEX50SS	1380 [54.3]	365 [14.4]	730 [28.7]	71.4 [157.1]
FLEX50SS.BX	1380 [54.3]	365 [14.4]	730 [28.7]	69.9 [153.8]
FLEX60SS.BX	1634 [64.3]	365 [14.4]	730 [28.7]	83.9 [184.6]
FLEX68SS	1840 [72.4]	365 [14.4]	730 [28.7]	97.1 [213.6]
FLEX68SS.BX	1840 [72.4]	365 [14.4]	730 [28.7]	95.1 [209.2]
FLEX68SS.BX2	1840 [72.4]	365 [14.4]	730 [28.7]	93.9 [206.7]
FLEX78SS.BX2	2090 [82.3]	365 [14.4]	730 [28.7]	107.8 [237.1]
FLEX86SS	2300 [90.5]	365 [14.4]	730 [28.7]	121.5 [267.3]
FLEX86SS.BX	2300 [90.5]	365 [14.4]	730 [28.7]	119.4 [262.7]
FLEX86SS.BX2	2300 [90.5]	365 [14.4]	730 [28.7]	118.8 [261.4]
FLEX104SS	2760 [108.7]	365 [14.4]	730 [28.7]	146.2 [321.6]
FLEX104SS.BX	2760 [108.7]	365 [14.4]	730 [28.7]	145.2 [319.4]
FLEX104SS.BX2	2760 [108.7]	365 [14.4]	730 [28.7]	193.8 [426.4]
FLEX122SS	3220 [126.7]	365 [14.4]	730 [28.7]	171.5 [377.3]
FLEX122SS.BX	3220 [126.7]	365 [14.4]	730 [28.7]	170.1 [374.2]
FLEX122SS.BX2	3220 [126.7]	365 [14.4]	730 [28.7]	168.9 [371.6]
FLEX140SS.BX	3680 [144.9]	365 [14.4]	730 [28.7]	195.2 [429.4]
FLEX140SS.BX2	3680 [144.9]	365 [14.4]	730 [28.7]	193.8 [426.4]
FLEX158SS	4140 [163]	365 [14.4]	730 [28.7]	222.1 [488.6]
FLEX158SS.BX2	4140 [163]	365 [14.4]	730 [28.7]	218.9 [481.6]

* Le poids de l'insert contient le(s) brûleur(s) (poids sec hors carburant), le verre anthracite et le verre. Il ne contient pas de verre anthracite pour les boîtes latérales.

IMPORTANT: L'encadrement ci-dessus de l'insert doit être autoportant. L'insert n'est pas porteur de charge complémentaire.

2. Faites glisser l'insert dans la cavité de l'ossature (la base de l'insert peut s'asseoir directement sur le matériau de l'ossature 2 x 4). Le produit est envoyé avec un ou des support(s) de stabilité rouge(s) installé(s) sur le(s) coté(s) ouvert(s) pour le maintenir fixe lors du transport et pendant l'installation. Laissez le(s) support(s) pendant l'encadrement afin de minimiser les mouvements du produit.

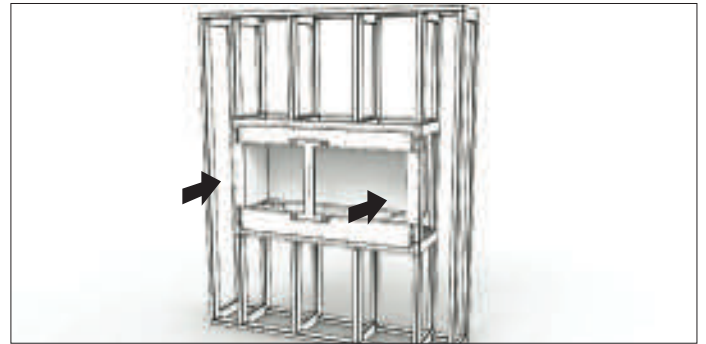

3. Fixez l'insert au cadre avec des vis en utilisant les trous de fixation existants sur les rebords du produit. Assurez-vous que l'insert soit nivelé avant de l'attacher de manière permanente.



4. Retirez les supports de stabilité rouges.

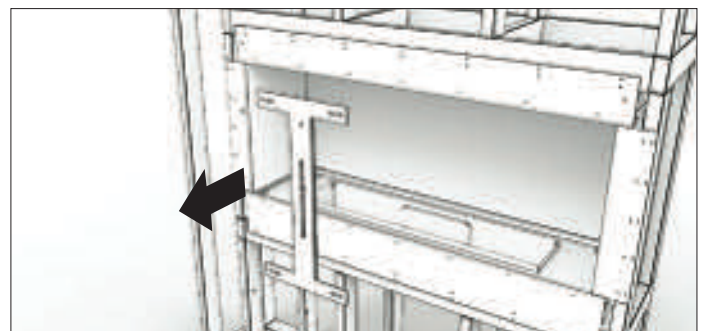

Installation Simple Face

5. Terminez la construction en finissant les panneaux muraux autour de l'insert. (Voir la section **INSTRUCTIONS SUR FINITIONS** et assurez-vous de bien comprendre où les matériaux non combustibles doivent être utilisés.)

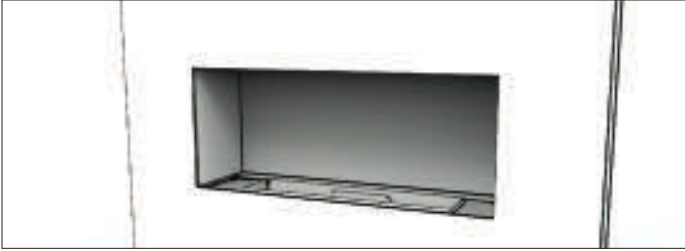

6. Placez le brûleur en position.



7. Retirez le ruban adhésif anti-poussière qui recouvre les fentes de montage de la vitre de protection.

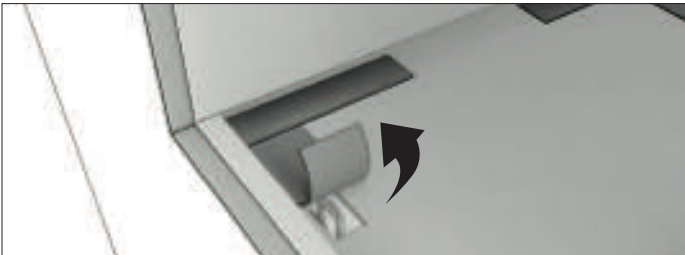

8. Si votre produit contient une boîte décorative à gauche / à droite, ou les deux, insérez-le ou les panneaux de verre internes en introduisant le verre vers le haut dans la fente, puis en le poussant vers le bas dans les clips préexistants.

** Les bûches décoratives ne doivent PAS être mises directement sur une flamme nue. Elles sont conçues pour être placées près de la chaleur mais pas sur la flamme elle-même.*

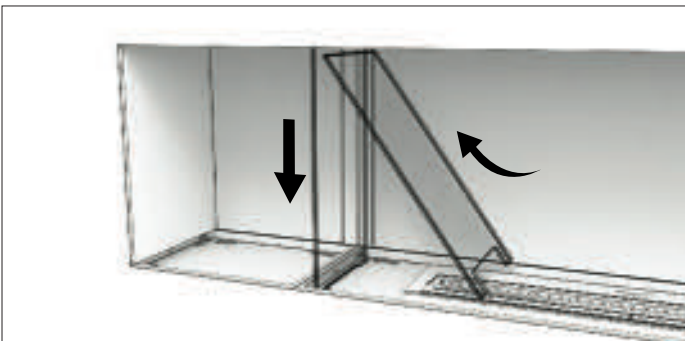

9. Installez la vitre de protection en insérant les deux extrémités dans les fentes appropriées de l'insert. Utilisez un peu de pression pour pousser la vitre de protection en place jusqu'à ce qu'elle glisse dans les clips de verre.

ATTENTION: Il s'agit d'un verre trempé - ce qui signifie une meilleure résistance par rapport à un verre normal. Un verre trempé peut toujours potentiellement casser. Les coins et les côtés sont des points de pression spécifiques où le verre est plus fragile et peut se casser en petits morceaux si non protégé. Pour éviter le risque de coupures, nous vous recommandons de porter des gants de protection pendant de la manipulation du verre.

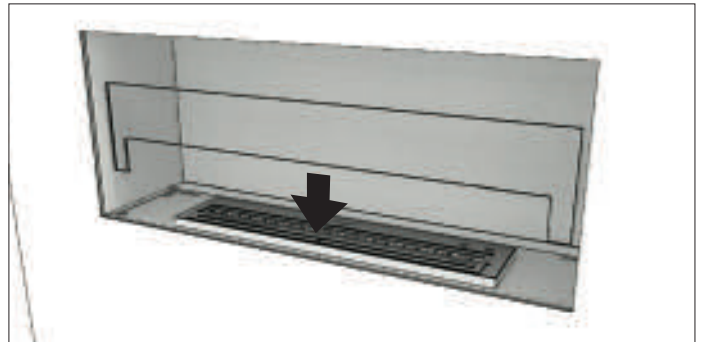

10. Étalez le verre anthracite uniformément autour du plateau de l'insert. **ATTENTION:** Assurez-vous que le couvercle du brûleur soit fermé. Gardez-le verre anthracite à distance de flamme du brûleur pour éviter qu'il atterrisse accidentellement dans la chambre du brûleur. Faites attention à ne pas rayer le brûleur.

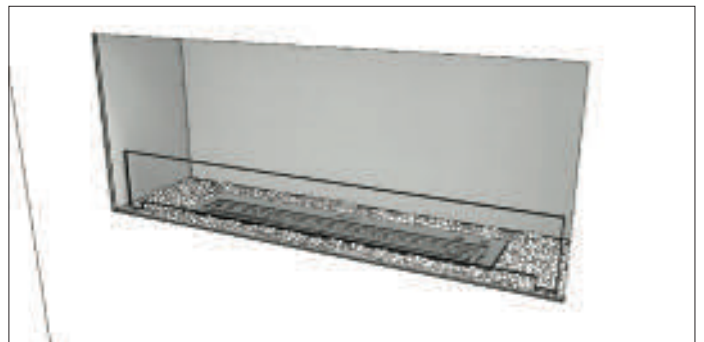

Installations

Côté Gauche et Côté Droit

Matériel nécessaire: Perceuse, Tournevis, Truelle pour le plâtre, Pistolet à silicone, Pistolet à calfeutrer.

1. Construisez le cadre du mur principale avec la taille d'ouverture indiquée dans le tableau B. La base du cadre peut être un solide banc / plate-forme, ce qui facilitera la mise à niveau de l'insert lorsqu'il est en position. N.B.: Les illustrations sont pour une installation côté gauche.



Tableau B: Taille D'ouverture du Cadre

Les dimensions du modèle réel devraient être comparées avec les dimensions de la découpe AVANT l'installation finale afin de confirmer l'alignement parfait.

L'INSERT (LC & RC)	L mm [in]	P mm [in]	H mm [in]	Poids* kg [lbs]
FLEX18LC	470 [18.5]	365 [14.4]	730 [28.7]	33 [72.6]
FLEX32LC	902 [35.5]	365 [14.4]	730 [28.7]	48.8 [107.4]
FLEX42LC	1157 [45.5]	365 [14.4]	730 [28.7]	63.3 [139.3]
FLEX50LC	1362 [53.6]	365 [14.4]	730 [28.7]	71.6k [157.5]
FLEX50LC.BX	1362 [53.6]	365 [14.4]	730 [28.7]	73.1 [160.8]
FLEX60LC.BX	1617 [63.7]	365 [14.4]	730 [28.7]	87.1 [191.6]
FLEX68LC	1822 [71.7]	365 [14.4]	730 [28.7]	100.3 [220.7]
FLEX68LC.BX	1822 [71.7]	365 [14.4]	730 [28.7]	95.3 [209.7]
FLEX68LC.BX2	1822 [71.7]	365 [14.4]	730 [28.7]	97kg [213.4]
FLEX78LC.BX2	2077 [81.8]	365 [14.4]	730 [28.7]	111 [244.2]
FLEX86LC	2282 [89.8]	365 [14.4]	730 [28.7]	121.7 [267.7]
FLEX86LC.BX	2282 [89.8]	365 [14.4]	730 [28.7]	122.6 [269.7]
FLEX86LC.BX2	2282 [89.8]	365 [14.4]	730 [28.7]	119 [261.8]
FLEX104LC	2742 [107.9]	365 [14.4]	730 [28.7]	149.5 [328.9]
FLEX104LC.BX	2742 [107.9]	365 [14.4]	730 [28.7]	145.4 [319.9]
FLEX104LC.BX2	2742 [107.9]	365 [14.4]	730 [28.7]	146.9 [323.2]
FLEX122LC	3202 [126.1]	365 [14.4]	730 [28.7]	171.7 [377.7]
FLEX122LC.BX	3202 [126.1]	365 [14.4]	730 [28.7]	173.4 [381.5]
FLEX122LC.BX2	3202 [126.1]	365 [14.4]	730 [28.7]	169.1 [372]
FLEX140LC.BX	3662 [144.2]	365 [14.4]	730 [28.7]	197.1 [433.6]
FLEX140LC.BX2	3662 [144.2]	365 [14.4]	730 [28.7]	195.4 [429.9]
FLEX158LC	4122 [162.3]	365 [14.4]	730 [28.7]	225.5 [496.1]
FLEX158LC.BX2	4122 [162.3]	365 [14.4]	730 [28.7]	219.1 [482]

* Le poids de l'insert contient le(s) brûleur(s) (poids sec hors carburant), le verre anthracite et le verre. Il ne contient pas de verre anthracite pour les boîtes latérales.

IMPORTANT: L'encadrement ci-dessus de l'insert doit être autoportant. L'insert n'est pas porteur de charge complémentaire.

2. Faites glisser l'insert dans la cavité de l'ossature (la base de l'insert peut s'asseoir directement sur le matériau de l'ossature 2 x 4). Le produit est envoyé avec un ou des support(s) de stabilité rouge(s) installé(s) sur le(s) coté(s) ouvert(s) pour le maintenir fixe lors du transport et pendant l'installation. Laissez le(s) support(s) pendant l'encadrement afin de minimiser les mouvements du produit. Alignez le panneau d'extension du rebord d'angle supérieur avec les trous filetés sur la structure supérieure et vissez-le à l'aide des vis fournies avec l'insert.

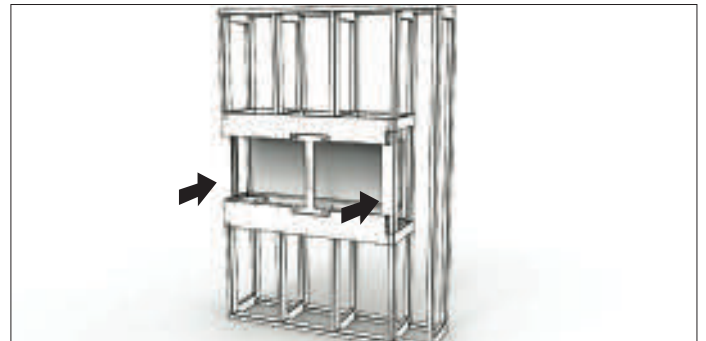

3. Fixez l'insert au cadre avec des vis en utilisant les trous de fixation existants sur les rebords du produit. Assurez-vous que l'insert soit nivelé avant de l'attacher de manière permanente.



4. Retirez les supports de stabilité rouges.

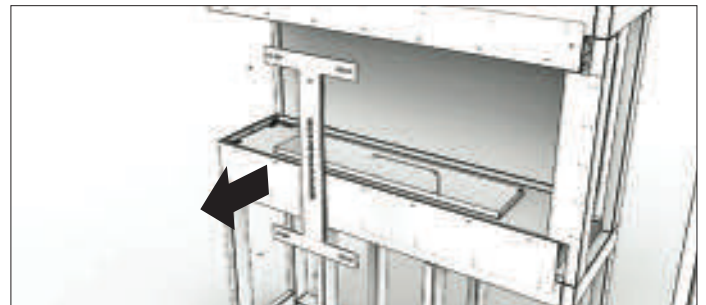

5. Terminez la construction en finissant les panneaux muraux autour de l'insert. (Voir la section **INSTRUCTIONS SUR FINITIONS** et assurez-vous de bien comprendre où les matériaux non combustibles doivent être utilisés.)



Installations Côté Gauche et Côté Droit

6. Placez le brûleur en position.

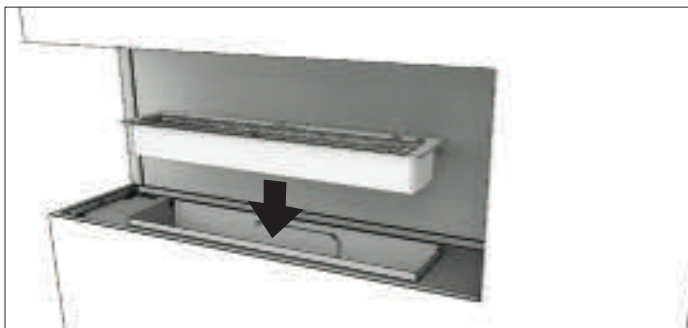

7. Retirez le ruban adhésif anti-poussière qui recouvre les fentes de montage de la vitre de protection.

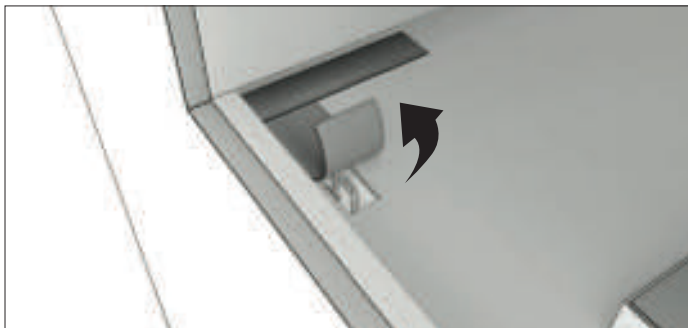

8. Si votre produit contient une boîte décorative à gauche / à droite, ou les deux, insérez-le ou les panneaux de verre internes en introduisant le verre vers le haut dans la fente, puis en le poussant vers le bas dans les clips préexistants.

** Les bûches décoratives ne doivent PAS être mises directement sur une flamme nue. Elles sont conçues pour être placées près de la chaleur mais pas sur la flamme elle-même.*

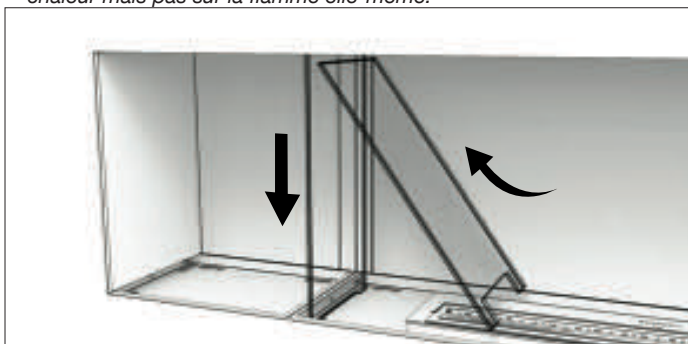

9. Insérez le panneau de verre dans l'un des côtés ouverts en insérant le verre dans l'ouverture située dans la partie supérieure de l'insert et en le rabaisant dans les fentes de la base jusqu'à ce qu'il soit complètement en place.



10. Installez la vitre de protection en insérant les deux extrémités dans les fentes appropriées de l'insert. Utilisez un peu de pression pour pousser la vitre de protection en place jusqu'à ce qu'elle glisse dans les clips de verre.

ATTENTION: Il s'agit d'un verre trempé - ce qui signifie une meilleure résistance par rapport à un verre normal. Un verre trempé peut toujours potentiellement casser. Les coins et les côtés sont des points de pression spécifiques où le verre est plus fragile et peut se casser en petits morceaux si non protégé. Pour éviter le risque de coupures, nous vous recommandons de porter des gants de protection pendant de la manipulation du verre.



11. Étalez le verre anthracite uniformément autour du plateau de l'insert. **ATTENTION:** Assurez-vous que le couvercle du brûleur soit fermé. Gardez-le verre anthracite à distance de flamme du brûleur pour éviter qu'il atterrisse accidentellement dans la chambre du brûleur. Faites attention à ne pas rayer le brûleur.

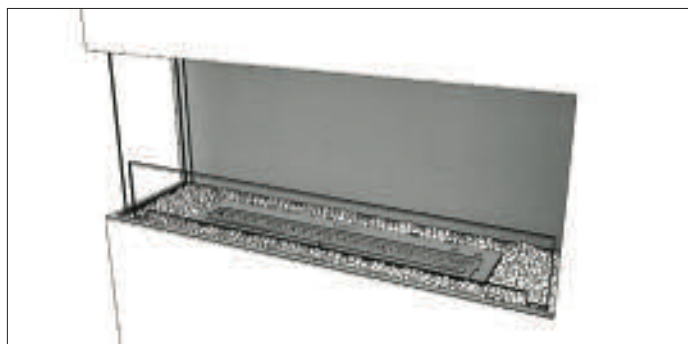

Installation

Baie

Matériel nécessaire: Perceuse, Tournevis, Truelle pour le plâtre, Pistolet à silicone, Pistolet à calfeutrer.

1. Construisez le cadre du mur principale avec la taille d'ouverture indiquée dans le tableau C. La base du cadre peut être un solide banc / plate-forme, ce qui facilitera la mise à niveau de l'insert lorsqu'il est en position.



Tableau C: Taille D'ouverture du Cadre

Les dimensions du modèle réel devraient être comparées avec les dimensions de la découpe AVANT l'installation finale afin de confirmer l'alignement parfait.

L'INSERT	L mm [in]	P mm [in]	H mm [in]	Poids* kg [lbs]
FLEX18BY	460 [18.1]	365 [14.4]	730 [28.7]	40.7 [89.5]
FLEX32BY	892 [35.1]	365 [14.4]	730 [28.7]	51.9 [114.2]
FLEX42BY	1147 [45.2]	365 [14.4]	730 [28.7]	66.5 [146.3]
FLEX50BY	1352 [53.2]	365 [14.4]	730 [28.7]	71.8 [158]
FLEX50BY.BX	1353 [53.3]	365 [14.4]	730 [28.7]	76.2 [167.6]
FLEX60BY.BX	1608 [63.3]	365 [14.4]	730 [28.7]	90.3 [198.7]
FLEX68BY	1813 [71.4]	365 [14.4]	730 [28.7]	103.6 [227.9]
FLEX68BY.BX	1813 [71.4]	365 [14.4]	730 [28.7]	95.5 [210.1]
FLEX68BY.BX2	1813 [71.4]	365 [14.4]	730 [28.7]	100.2 [220.4]
FLEX78BY.BX2	2068 [81.4]	365 [14.4]	730 [28.7]	114 [250.8]
FLEX86BY	2272 [89.4]	365 [14.4]	730 [28.7]	121.9 [268.2]
FLEX86BY.BX	2272 [89.4]	365 [14.4]	730 [28.7]	125.9 [277]
FLEX86BY.BX2	2272 [89.4]	365 [14.4]	730 [28.7]	119.2 [262.2]
FLEX104BY	2733 [107.6]	365 [14.4]	730 [28.7]	152.9 [336.4]
FLEX104BY.BX	2733 [107.6]	365 [14.4]	730 [28.7]	145.6 [320.3]
FLEX104BY.BX2	2733 [107.6]	365 [14.4]	730 [28.7]	150.1 [330.2]
FLEX122BY	3193 [125.7]	365 [14.4]	730 [28.7]	171.9 [378.2]
FLEX122BY.BX	3193 [125.7]	365 [14.4]	730 [28.7]	176.7 [388.7]
FLEX122BY.BX2	3193 [125.7]	365 [14.4]	730 [28.7]	169.3 [372.5]
FLEX140BY.BX	3653 [143.8]	365 [14.4]	730 [28.7]	195.6 [430.3]
FLEX140BY.BX2	3653 [143.8]	365 [14.4]	730 [28.7]	200.3 [440.7]
FLEX158BY	4113 [161.9]	365 [14.4]	730 [28.7]	228.8 [503.4]
FLEX158BY.BX2	4113 [161.9]	365 [14.4]	730 [28.7]	219.3 [482.5]

* Le poids de l'insert contient le(s) brûleur(s) (poids sec hors carburant), le verre anthracite et le verre. Il ne contient pas de verre anthracite pour les boîtes latérales.

IMPORTANT: L'encadrement ci-dessus de l'insert doit être autoportant. L'insert n'est pas porteur de charge complémentaire.

2. Faites glisser l'insert dans la cavité de l'ossature (la base de l'insert peut s'asseoir directement sur le matériau de l'ossature 2 x 4). Le produit est envoyé avec un ou des support(s) de stabilité rouge(s) installé(s) sur le(s) coté(s) ouvert(s) pour le maintenir fixe lors du transport et pendant l'installation. Laissez le(s) support(s) pendant l'encadrement afin de minimiser les mouvements du produit.

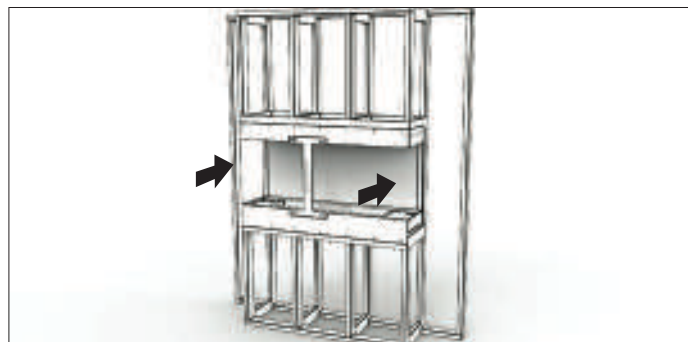

3. Assurez-vous que le côté gauche et droite de l'insert soient alignés avec l'encadrement.

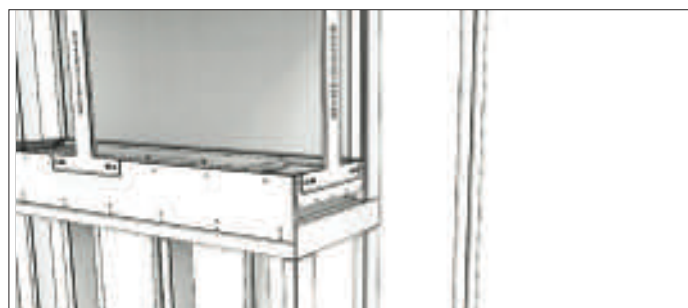

4. Fixez l'insert au cadre avec des vis en utilisant les trous de fixation existants sur les rebords du produit. Assurez-vous que l'insert soit nivelé avant de l'attacher de manière permanente.

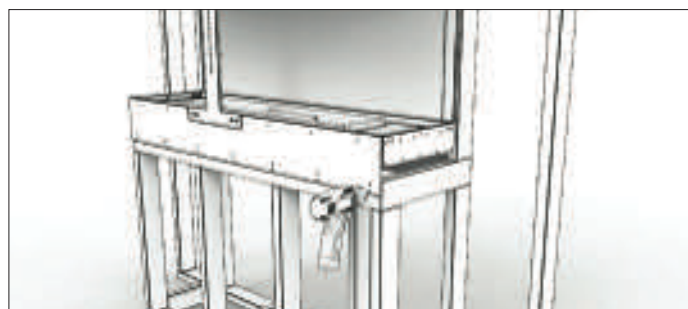

5. Retirez les supports de stabilité rouges.

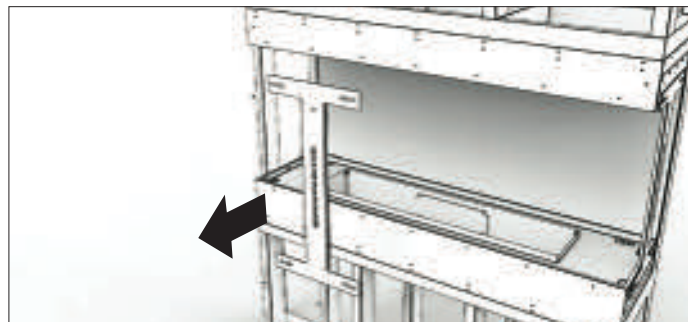

Installation Baie

50

6. Terminez la construction en finissant les panneaux muraux autour de l'insert. (Voir la section **INSTRUCTIONS SUR FINITIONS** et assurez-vous de bien comprendre où les matériaux non combustibles doivent être utilisés.)

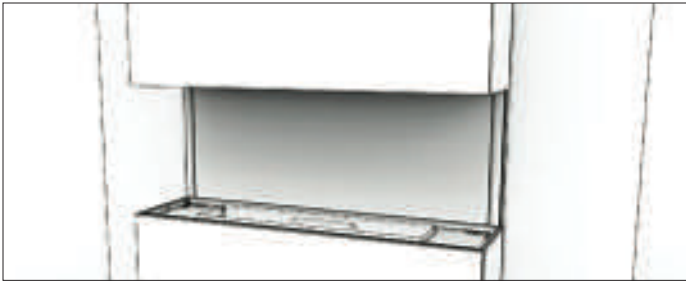

7. Placez le brûleur en position.

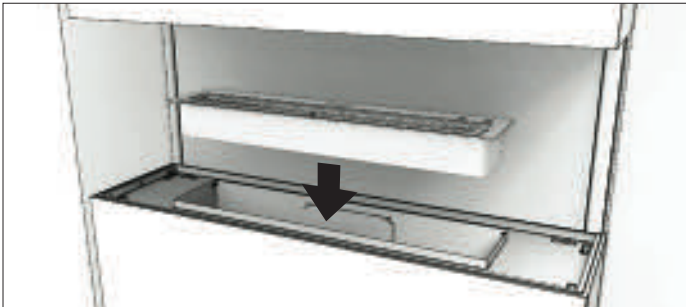

8. Retirez le ruban adhésif anti-poussière qui recouvre les fentes de montage de la vitre de protection.

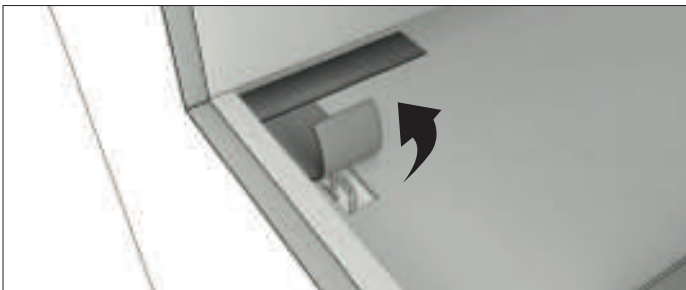

9. Si votre produit contient une boîte décorative à gauche / à droite, ou les deux, insérez-le ou les panneaux de verre internes en introduisant le verre vers le haut dans la fente, puis en le poussant vers le bas dans les clips préexistants.

** Les bûches décoratives ne doivent PAS être mises directement sur une flamme nue. Elles sont conçues pour être placées près de la chaleur mais pas sur la flamme elle-même.*

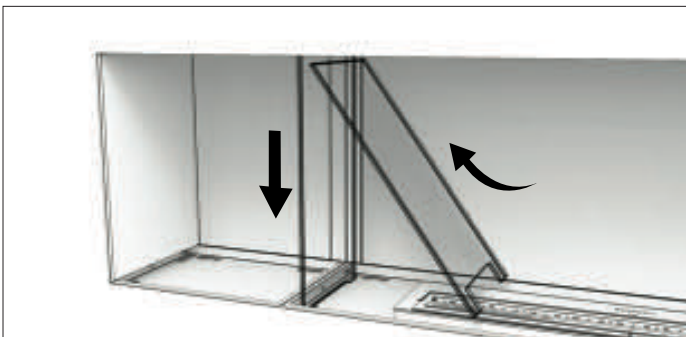

10. Insérez le panneau de verre dans l'un des côtés ouverts en insérant le verre dans l'ouverture située dans la partie supérieure de l'insert et en le rabaisant dans les fentes de la base jusqu'à ce qu'il soit complètement en place. Répétez l'opération pour l'autre côté de l'insert.

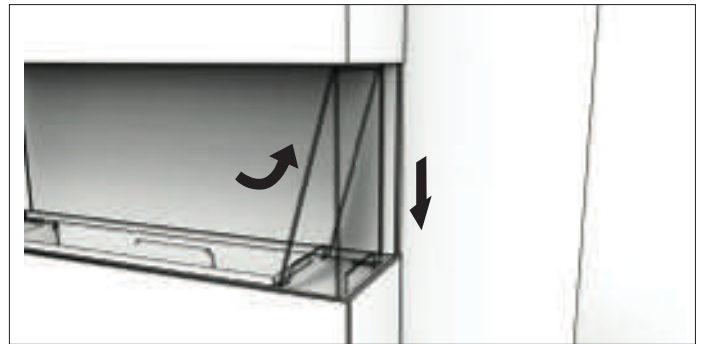

11. Installez la vitre de protection en insérant les deux extrémités dans les fentes appropriées de l'insert. Utilisez un peu de pression pour pousser la vitre de protection en place jusqu'à ce qu'elle glisse dans les clips de verre.

ATTENTION: Il s'agit d'un verre trempé - ce qui signifie une meilleure résistance par rapport à un verre normal. Un verre trempé peut toujours potentiellement casser. Les coins et les côtés sont des points de pression spécifiques où le verre est plus fragile et peut se casser en petits morceaux si non protégé. Pour éviter le risque de coupures, nous vous recommandons de porter des gants de protection pendant de la manipulation du verre.

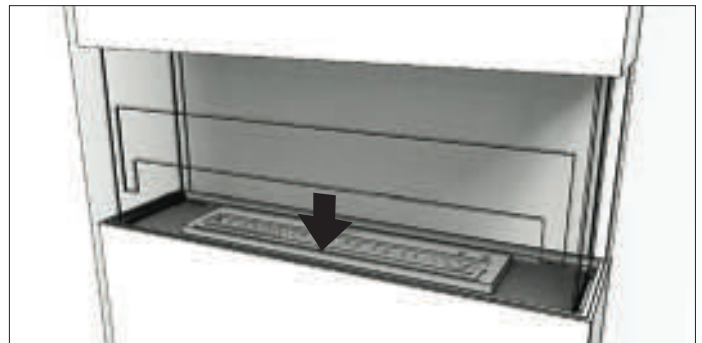

12. Étalez le verre anthracite uniformément autour du plateau de l'insert. **ATTENTION:** Assurez-vous que le couvercle du brûleur soit fermé. Gardez-le verre anthracite à distance de flamme du brûleur pour éviter qu'il atterrisse accidentellement dans la chambre du brûleur. Faites attention à ne pas rayer le brûleur.

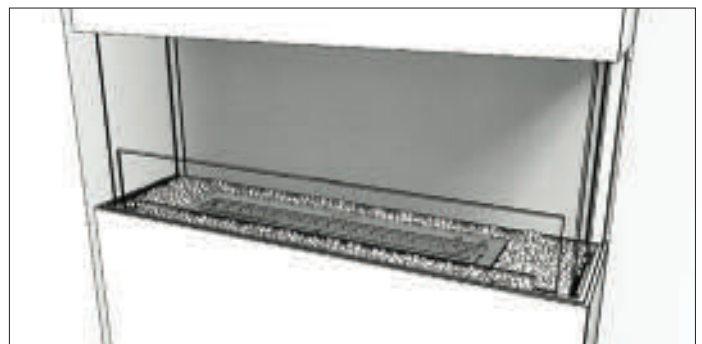

Installation Double Face

Matériel nécessaire: Perceuse, Tournevis, Truelle pour le plâtre, Pistolet à silicone, Pistolet à calfeutrer.

1. Construisez le cadre du mur principale avec la taille d'ouverture indiquée dans le tableau D. La base du cadre peut être un solide banc / plate-forme, ce qui facilitera la mise à niveau de l'insert lorsqu'il est en position.

ATTENTION : Les inserts double face ne peuvent pas être installés dans un mur simple face, les vitres des deux côtés ne devant pas être obstruées dans la cavité double. Ne pas appliquer de pression ou placer des matériaux sur les vitres. Les inserts à double face ont été conçus pour être placés dans un mur séparant deux pièces. Le mur pourrait surchauffer ou s'enflammer si obstrué et non conforme aux instructions d'installation.



Tableau D: Taille D'ouverture du Cadre

Les dimensions du modèle réel devraient être comparées avec les dimensions de la découpe AVANT l'installation finale afin de confirmer l'alignement parfait.

L'INSERT	L mm [in]	P mm [in]	H mm [in]	Poids* kg [lbs]
FLEX18DB	488 [19.2]	349 [13.6]	730 [28.7]	26.5 [58.3]
FLEX32DB	922 [36.3]	349 [13.6]	730 [28.7]	46.6 [102.5]
FLEX42DB	1177 [46.3]	349 [13.6]	730 [28.7]	61.4 [135.1]
FLEX50DB	1380 [54.3]	349 [13.6]	730 [28.7]	70.8 [155.8]
FLEX50DB.BX	1380 [54.3]	349 [13.6]	730 [28.7]	70 [154]
FLEX60DB.BX	1634 [64.3]	349 [13.6]	730 [28.7]	83.3 [183.3]
FLEX68DB	1840 [72.4]	349 [13.6]	730 [28.7]	95.5 [210.1]
FLEX68DB.BX	1840 [72.4]	349 [13.6]	730 [28.7]	83.7 [184.1]
FLEX68DB.BX2	1840 [72.4]	349 [13.6]	730 [28.7]	94.8 [208.6]
FLEX78DB.BX2	2090 [82.3]	349 [13.6]	730 [28.7]	106.2 [233.6]
FLEX86DB	2300 [90.5]	349 [13.6]	730 [28.7]	102.3 [225.1]
FLEX86DB.BX	2300 [90.5]	349 [13.6]	730 [28.7]	124.5 [273.9]
FLEX86DB.BX2	2300 [90.5]	349 [13.6]	730 [28.7]	108.5 [238.7]
FLEX104DB	2760 [108.7]	349 [13.6]	730 [28.7]	145.7 [320.5]
FLEX104DB.BX	2760 [108.7]	349 [13.6]	730 [28.7]	127.1 [279.6]
FLEX104DB.BX2	2760 [108.7]	349 [13.6]	730 [28.7]	142 [312]
FLEX122DB	3220 [126.7]	349 [13.6]	730 [28.7]	145.6 [320.3]
FLEX122DB.BX	3220 [126.7]	349 [13.6]	730 [28.7]	170.1 [374.2]
FLEX122DB.BX2	3220 [126.7]	349 [13.6]	730 [28.7]	151.9 [334.2]
FLEX140DB.BX	3680 [144.9]	349 [13.6]	730 [28.7]	170.4 [374.9]
FLEX140DB.BX2	3680 [144.9]	349 [13.6]	730 [28.7]	192.9 [424.4]
FLEX158DB	4140 [163]	349 [13.6]	730 [28.7]	226.8 [499]
FLEX158DB.BX2	4140 [163]	349 [13.6]	730 [28.7]	195.2 [429.4]

* Le poids de l'insert contient le(s) brûleur(s) (poids sec hors carburant), le verre anthracite et le verre. Il ne contient pas de verre anthracite pour les boîtes latérales.

IMPORTANT: L'encadrement ci-dessus de l'insert doit être autoportant. L'insert n'est pas porteur de charge complémentaire.

2. Retirez le rebord d'extension du foyer de manière à ce que les deux côtés aient la même hauteur. Cela aidera à faire glisser le foyer dans le cadre plus facilement. Faites attention à ne pas perdre les vis, elles seront nécessaires une fois le rebord réinstallé.

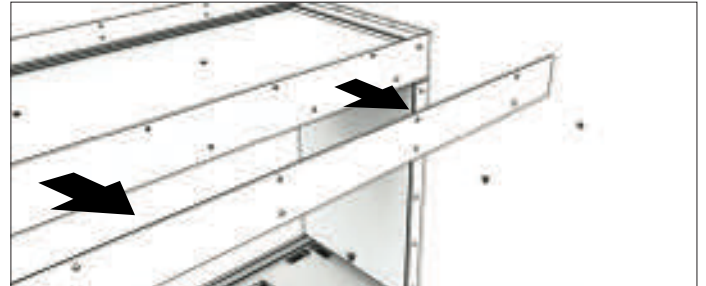

3. Faites glisser l'insert dans la cavité de l'ossature (la base de l'insert peut s'asseoir directement sur le matériau de l'ossature 2 x 4). Le produit est envoyé avec un ou des support(s) de stabilité rouge(s) installé(s) sur le(s) côté(s) ouvert(s) pour le maintenir fixe lors du transport et pendant l'installation. Laissez le(s) support(s) pendant l'encadrement afin de minimiser les mouvements du produit.



4. Alignez le panneau d'extension du rebord avec les trous filetés de le produit. Vissez-le en place à l'aide de vis (partie inférieure de l'insert, partie supérieure du matériel d'encadrement) pour le fixer en place.

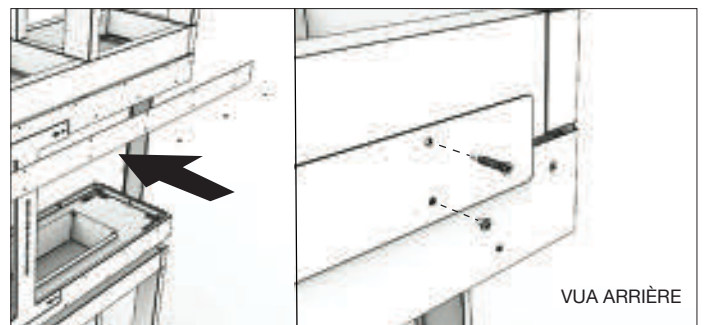

5. Fix the appliance to the framework with screws using the existing mounting holes on the appliance flanges. Make sure that the appliance is level before securing it in place.

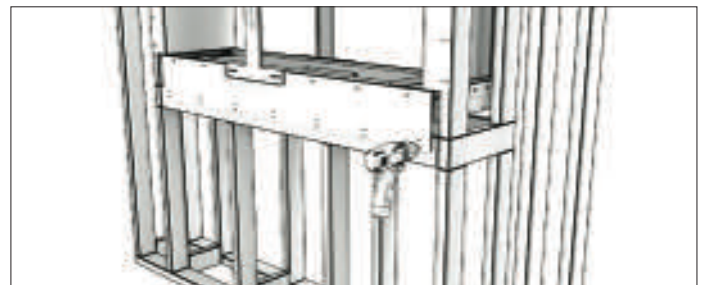

Installation Double Face

52

6. Retirez les supports de stabilité rouges.

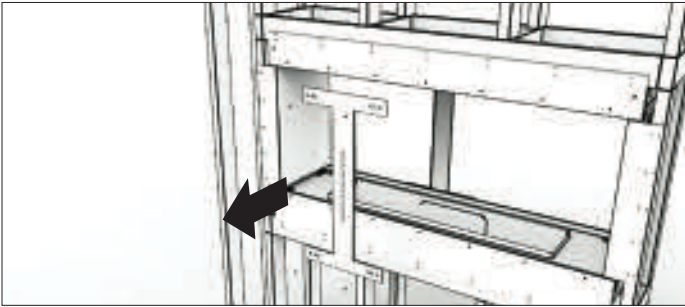

7. Terminez la construction en finissant les panneaux muraux autour de l'insert.
(Voir la section **INSTRUCTIONS SUR FINITIONS** et assurez-vous de bien comprendre où les matériaux non combustibles doivent être utilisés.)



8. Placez le brûleur en position.

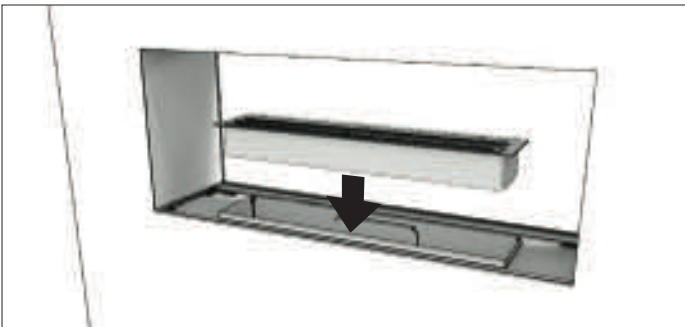

9. Retirez le ruban adhésif anti-poussière qui recouvre les fentes de montage de la vitre de protection.

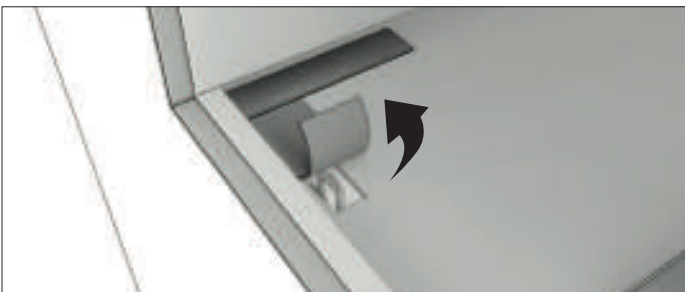

10. Si votre produit contient une boîte décorative à gauche / à droite, ou les deux, insérez-le ou les panneaux de verre internes en introduisant le verre vers le haut dans la fente, puis en le poussant vers le bas dans les clips préexistants.

** Les bûches décoratives ne doivent PAS être mises directement sur une flamme nue. Elles sont conçues pour être placées près de la chaleur mais pas sur la flamme elle-même.*

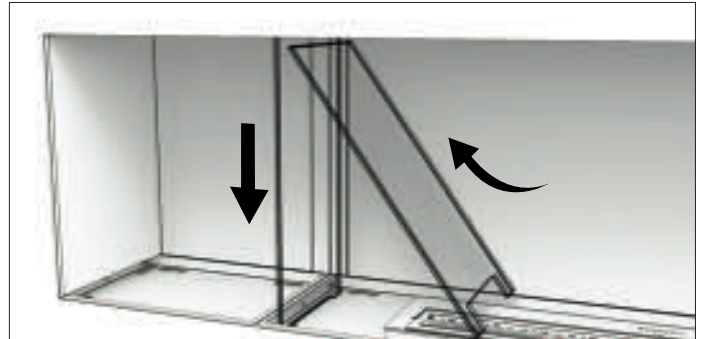

11. Installez la vitre de protection en insérant les deux extrémités dans les fentes appropriées de l'insert. Utilisez un peu de pression pour pousser la vitre de protection en place jusqu'à ce qu'elle glisse dans les clips de verre.

ATTENTION: Il s'agit d'un verre trempé - ce qui signifie une meilleure résistance par rapport à un verre normal. Un verre trempé peut toujours potentiellement casser. Les coins et les côtés sont des points de pression spécifiques où le verre est plus fragile et peut se casser en petits morceaux si non protégé. Pour éviter le risque de coupures, nous vous recommandons de porter des gants de protection pendant de la manipulation du verre.

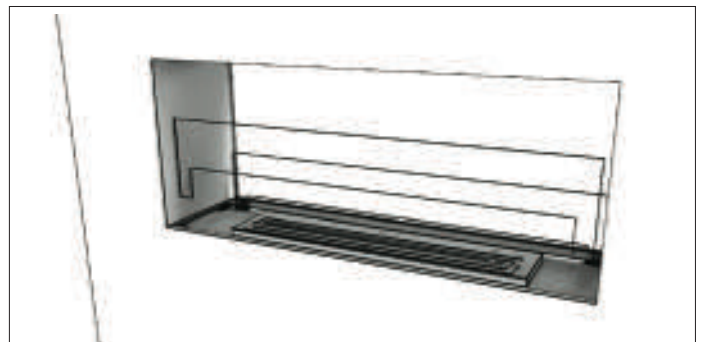

12. Étalez le verre anthracite uniformément autour du plateau de l'insert. **ATTENTION:** Assurez-vous que le couvercle du brûleur soit fermé. Gardez-le verre anthracite à distance de flamme du brûleur pour éviter qu'il atterrisse accidentellement dans la chambre du brûleur. Faites attention à ne pas rayer le brûleur.

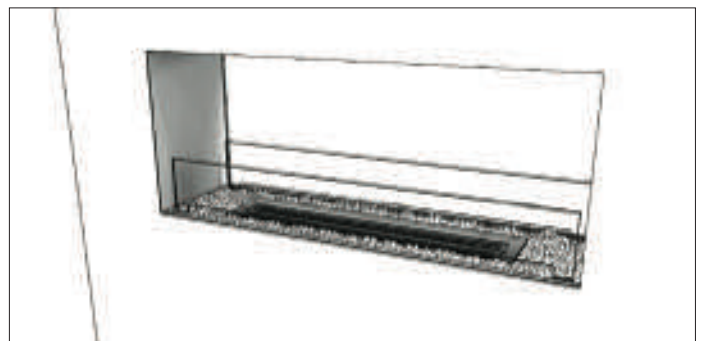

Installation Peninsule

Matériel nécessaire: Perceuse, Tournevis, Truelle pour le plâtre, Pistolet à silicone, Pistolet à calfeutrer.

1. Construisez le cadre du mur principale avec la taille d'ouverture indiquée dans le tableau E. La base du cadre peut être un solide banc / plate-forme, ce qui facilitera la mise à niveau de l'insert lorsqu'il est en position.

ATTENTION: : Les inserts triple face ne peuvent pas être installés dans un mur simple face, les vitres des deux côtés ne devant pas être obstruées dans la cavité double. Ne pas appliquer de pression ou placer des matériaux sur les vitres. Les inserts à triple face ont été conçus pour être placés dans un mur séparant deux pièces. Le mur pourrait surchauffer ou s'enflammer si obstrué et non conforme aux instructions d'installation.



Tableau E: Taille D'ouverture du Cadre

Les dimensions du modèle réel devraient être comparées avec les dimensions de la découpe AVANT l'installation finale afin de confirmer l'alignement parfait.

L'INSERT	L mm [in]	P mm [in]	H mm [in]	Poids* kg [lbs]
FLEX18PN	470 [18.5]	349 [13.6]	730 [28.7]	34.2 [75.2]
FLEX32PN	902 [35.5]	349 [13.6]	730 [28.7]	49.8 [109.6]
FLEX42PN	1157 [45.5]	349 [13.6]	730 [28.7]	64.7 [142.3]
FLEX50PN	1362 [53.6]	349 [13.6]	730 [28.7]	59.1 [130]
FLEX50PN.BX	1362 [53.6]	349 [13.6]	730 [28.7]	73.2 [161]
FLEX60PN.BX	1617 [63.7]	349 [13.6]	730 [28.7]	87.5 [192.5]
FLEX68PN	1822 [71.7]	349 [13.6]	730 [28.7]	102.8 [226.2]
FLEX68PN.BX	1822 [71.7]	349 [13.6]	730 [28.7]	83.9 [184.6]
FLEX68PN.BX2	1822 [71.7]	349 [13.6]	730 [28.7]	96.1 [211.4]
FLEX78PN.BX2	2077 [81.8]	349 [13.6]	730 [28.7]	110.4 [242.9]
FLEX86PN	2282 [89.8]	349 [13.6]	730 [28.7]	102.5 [225.5]
FLEX86PN.BX	2282 [89.8]	349 [13.6]	730 [28.7]	124.1 [273]
FLEX86PN.BX2	2282 [89.8]	349 [13.6]	730 [28.7]	108.7 [239.1]
FLEX104PN	2742 [107.9]	349 [13.6]	730 [28.7]	153.3 [337.3]
FLEX104PN.BX	2742 [107.9]	349 [13.6]	730 [28.7]	127.3 [280.1]
FLEX104PN.BX2	2742 [107.9]	349 [13.6]	730 [28.7]	147.3 [324.1]
FLEX122PN	3202 [126.1]	349 [13.6]	730 [28.7]	145.8 [320.8]
FLEX122PN.BX	3202 [126.1]	349 [13.6]	730 [28.7]	176.2 [387.6]
FLEX122PN.BX2	3202 [126.1]	349 [13.6]	730 [28.7]	152.1 [334.6]
FLEX140PN.BX	3662 [144.2]	349 [13.6]	730 [28.7]	170.6 [375.3]
FLEX140PN.BX2	3662 [144.2]	349 [13.6]	730 [28.7]	198.7 [437.1]
FLEX158PN	4122 [162.3]	349 [13.6]	730 [28.7]	231.8 [510]
FLEX158PN.BX2	4122 [162.3]	349 [13.6]	730 [28.7]	195.4 [429.9]

* Le poids de l'insert contient le(s) brûleur(s) (poids sec hors carburant), le verre anthracite et le verre. Il ne contient pas de verre anthracite pour les boîtes latérales.

IMPORTANT: L'encadrement ci-dessus de l'insert doit être autoportant. L'insert n'est pas porteur de charge complémentaire.

2. Remove the extension flange from the firebox so that both sides are the same height. This will help make sliding the firebox into the frame easier. Pay attention not to lose the screws, they will be needed again when the flange is re-installed.



3. Faites glisser l'insert dans la cavité de l'ossature (la base de l'insert peut s'asseoir directement sur le matériau de l'ossature 2 x 4). Le produit est envoyé avec un ou des support(s) de stabilité rouge(s) installé(s) sur le(s) coté(s) ouvert(s) pour le maintenir fixe lors du transport et pendant l'installation. Laissez le(s) support(s) pendant l'encadrement afin de minimiser les mouvements du produit.

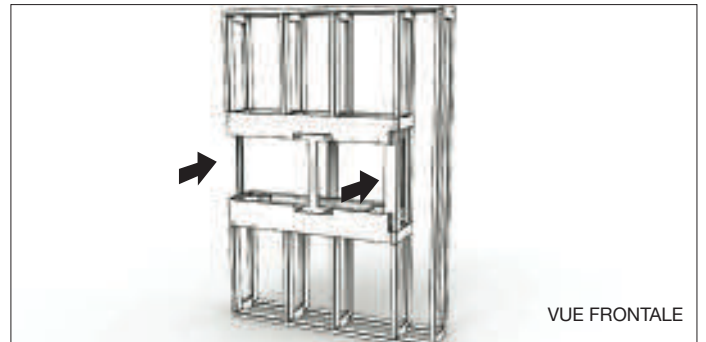

4. Assurez-vous que le côté derrière et côtés ouverts du produit sont alignés avec l'encadrement.

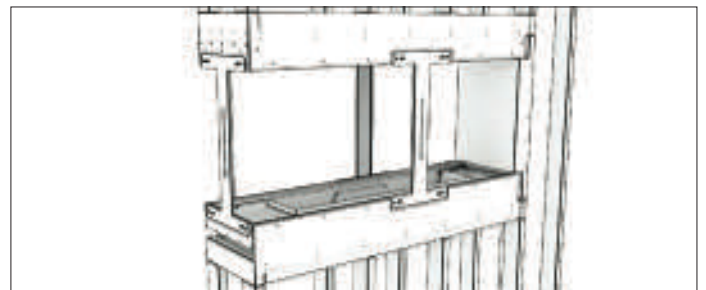

5. Alignez le panneau d'extension du rebord avec les trous filetés de le produit. Vissez-le en place à l'aide de vis (partie inférieure de l'insert, partie supérieure du matériel d'encadrement) pour le fixer en place.

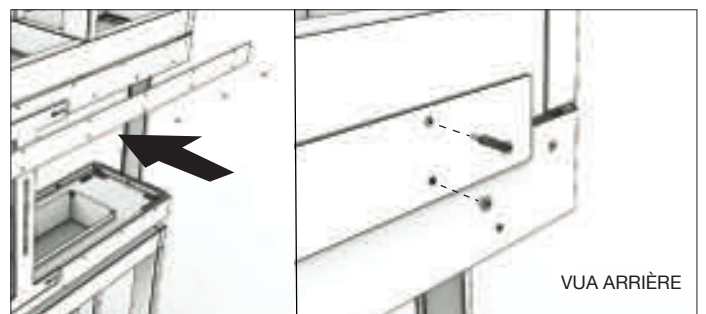

Installation Peninsule

6. Fix the appliance to the framework with screws using the existing mounting holes on the appliance flanges. Make sure that the appliance is level before securing it in place.

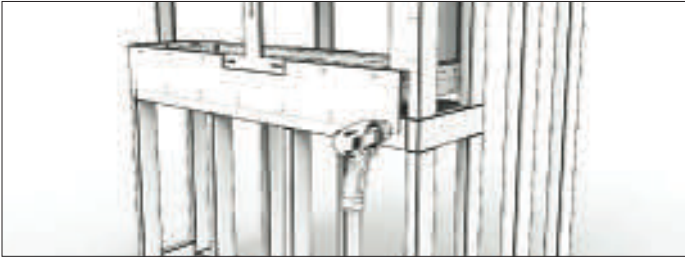

7. Retirez les supports de stabilité rouges.

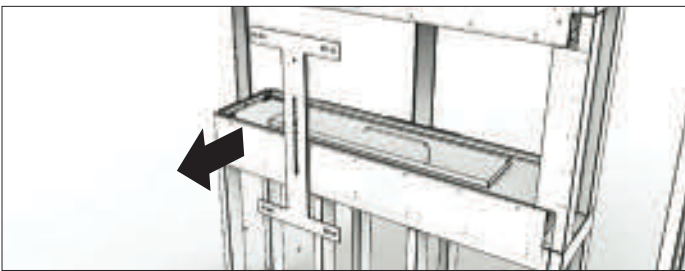

8. Terminez la construction en finissant les panneaux muraux autour de l'insert. (Voir la section **INSTRUCTIONS SUR FINITIONS** et assurez-vous de bien comprendre où les matériaux non combustibles doivent être utilisés.)



9. Placez le brûleur en position.

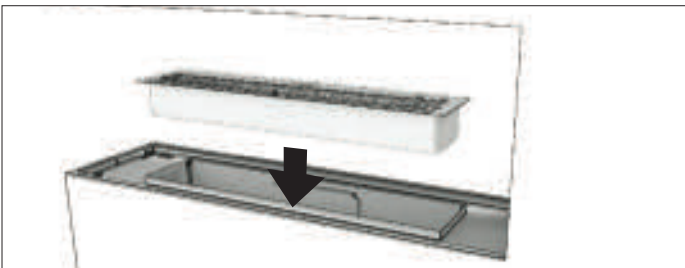

10. Retirez le ruban adhésif anti-poussière qui recouvre les fentes de montage de la vitre de protection.

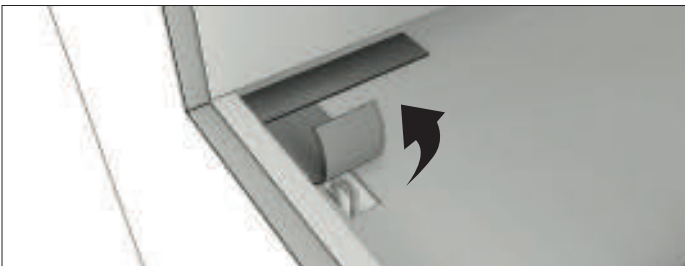

11. Si votre produit contient une boîte décorative à gauche / à droite, ou les deux, insérez-le ou les panneaux de verre internes en introduisant le verre vers le haut dans la fente, puis en le poussant vers le bas dans les clips préexistants.

** Les bûches décoratives ne doivent PAS être mises directement sur une flamme nue. Elles sont conçues pour être placées près de la chaleur mais pas sur la flamme elle-même.*

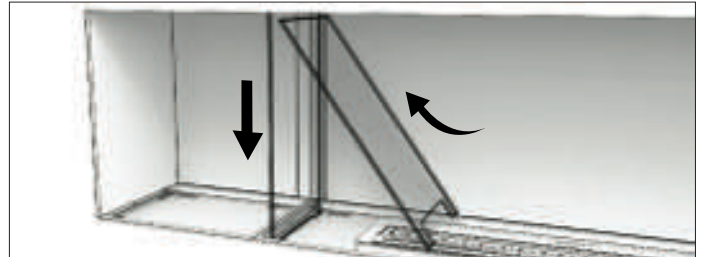

12. Insérez le panneau de verre dans l'un des côtés ouverts en insérant le verre dans l'ouverture située dans la partie supérieure de l'insert et en le rabaisant dans les fentes de la base jusqu'à ce qu'il soit complètement en place.

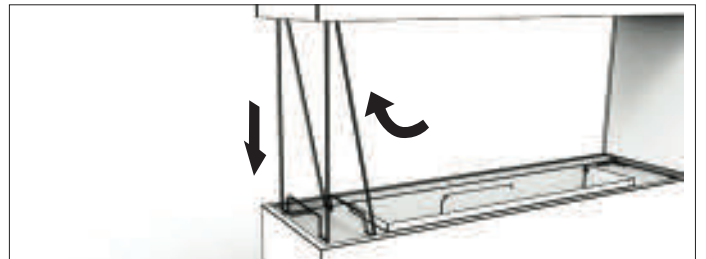

13. Installez la vitre de protection en insérant les deux extrémités dans les fentes appropriées de l'insert. Utilisez un peu de pression pour pousser la vitre de protection en place jusqu'à ce qu'elle glisse dans les clips de verre.

ATTENTION: Il s'agit d'un verre trempé - ce qui signifie une meilleure résistance par rapport à un verre normal. Un verre trempé peut toujours potentiellement casser. Les coins et les côtés sont des points de pression spécifiques où le verre est plus fragile et peut se casser en petits morceaux si non protégé. Pour éviter le risque de coupures, nous vous recommandons de porter des gants de protection pendant de la manipulation du verre.

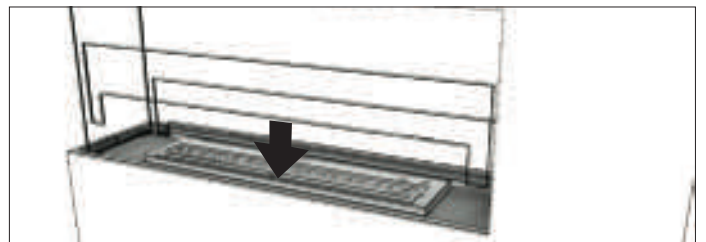

14. Étalez le verre anthracite uniformément autour du plateau de l'insert. **ATTENTION:** Assurez-vous que le couvercle du brûleur soit fermé. Gardez-le verre anthracite à distance de flamme du brûleur pour éviter qu'il atterrisse accidentellement dans la chambre du brûleur. Faites attention à ne pas rayer le brûleur.

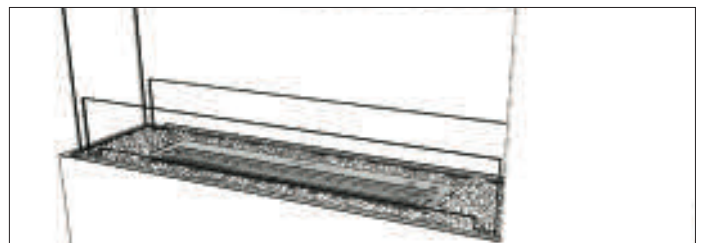

Ile Installation

Matériel nécessaire: Perceuse, Tournevis, Truelle pour le plâtre, Pistolet à silicone, Pistolet à calfeutrer.

1. Construisez la structure avec les dimensions d'ouverture indiquées dans le tableau F. La base du cadre peut être un solide banc / plate-forme, ce qui facilitera la mise à niveau de l'insert lorsqu'il est en position.

ATTENTION: Cet appareil à quatre faces ne peut pas être inséré dans une structure murale. Il doit être installé sur une structure séparée solidement ancrée au sol. N'installez pas sur une structure mobile ou peu solide. La partie supérieure de l'appareil doit être installée sur un cadre fixé au plafond et aligné avec le cadre inférieur. Les appareils à quatre faces sont conçus comme des inserts muraux de séparation. Le mur pourrait surchauffer ou s'enflammer si obstrué et non conforme aux instructions d'installation.



Tableau F: Taille D'ouverture du Cadre

Les dimensions du modèle réel devraient être comparées avec les dimensions de la découpe AVANT l'installation finale afin de confirmer l'alignement parfait.

L'INSERT	L mm [in]	P mm [in]	H mm [in]	Poids* kg [lbs]
FLEX18IL	455 [17.9]	349 [13.6]	730 [28.7]	22.2 [48.9]
FLEX32IL	887 [34.9]	349 [13.6]	730 [28.7]	33.5 [73.7]
FLEX42IL	1142 [45]	349 [13.6]	730 [28.7]	49.8 [109.6]
FLEX50IL	1347 [53]	349 [13.6]	730 [28.7]	59.9 [131.8]
FLEX50IL.BX	1347 [53]	349 [13.6]	730 [28.7]	48.3 [106.3]
FLEX60IL.BX	1602 [63.1]	349 [13.6]	730 [28.7]	64.6 [142.2]
FLEX68IL	1807 [71.1]	349 [13.6]	730 [28.7]	75.2 [165.5]
FLEX68IL.BX	1807 [71.1]	349 [13.6]	730 [28.7]	74.7 [164.4]
FLEX68IL.BX2	1807 [71.1]	349 [13.6]	730 [28.7]	63.1 [138.9]
FLEX78IL.BX2	2062 [81.2]	349 [13.6]	730 [28.7]	79.4 [174.8]
FLEX86IL	2267 [89.3]	349 [13.6]	730 [28.7]	101.5 [223.2]
FLEX86IL.BX	2267 [89.3]	349 [13.6]	730 [28.7]	90 [198.1]
FLEX86IL.BX2	2267 [89.3]	349 [13.6]	730 [28.7]	89.5 [197]
FLEX104IL	2727 [107.4]	349 [13.6]	730 [28.7]	116.3 [255.9]
FLEX104IL.BX	2727 [107.4]	349 [13.6]	730 [28.7]	116.3 [255.9]
FLEX104IL.BX2	2727 [107.4]	349 [13.6]	730 [28.7]	104.8 [230.6]
FLEX122IL	3187 [125.5]	349 [13.6]	730 [28.7]	148.6 [327]
FLEX122IL.BX	3187 [125.5]	349 [13.6]	730 [28.7]	131.1 [288.4]
FLEX122IL.BX2	3187 [125.5]	349 [13.6]	730 [28.7]	131.1 [288.4]
FLEX140IL.BX	3647 [143.6]	349 [13.6]	730 [28.7]	163.4 [359.6]
FLEX140IL.BX2	3647 [143.6]	349 [13.6]	730 [28.7]	145.9 [321.1]
FLEX158IL	4107 [161.7]	349 [13.6]	730 [28.7]	173.9 [382.6]
FLEX158IL.BX2	4107 [161.7]	349 [13.6]	730 [28.7]	178.3 [392.2]

* Le poids de l'insert contient le(s) brûleur(s) (poids sec hors carburant), le verre anthracite et le verre. Il ne contient pas de verre anthracite pour les boîtes latérales.

IMPORTANT: L'encadrement ci-dessus de l'insert doit être autoportant. L'insert n'est pas porteur de charge complémentaire.

2. Retirez le rebord d'extension du foyer de manière à ce que les deux côtés aient la même hauteur. Cela aidera à faire glisser le foyer dans le cadre plus facilement. Faites attention à ne pas perdre les vis, elles seront nécessaires une fois le rebord réinstallé.

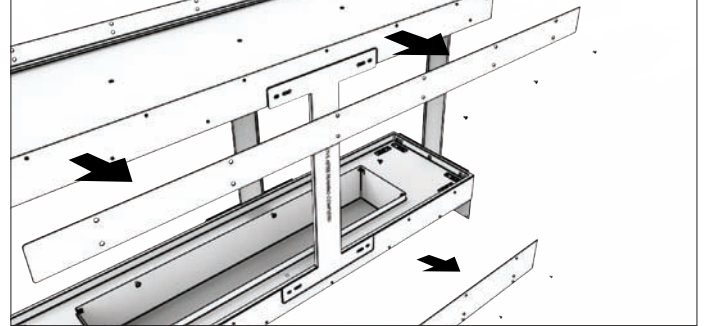

3. Faites glisser l'insert dans la cavité de l'ossature (la base de l'insert peut s'asseoir directement sur le matériau de l'ossature 2 x 4). Le produit est envoyé avec un ou des support(s) de stabilité rouge(s) installé(s) sur le(s) côté(s) ouvert(s) pour le maintenir fixe lors du transport et pendant l'installation. Laissez le(s) support(s) pendant l'encadrement afin de minimiser les mouvements du produit.

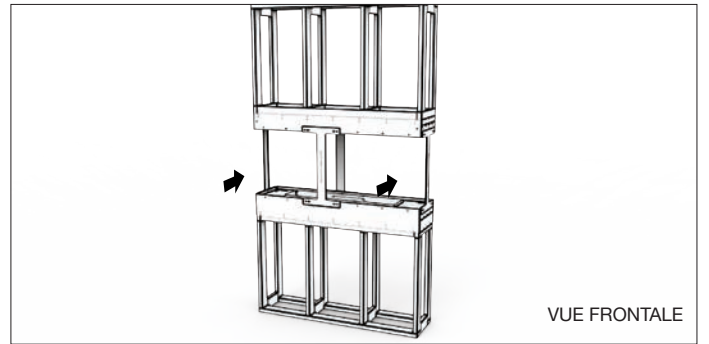

4. Alignez le panneau d'extension du rebord avec les trous filetés de le produit. Vissez-le en place à l'aide de vis (partie inférieure de l'insert, partie supérieure du matériel d'encadrement) pour le fixer en place.

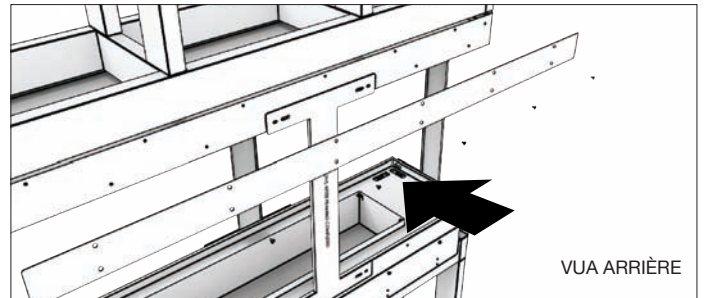

5. Fix the appliance to the framework with screws using the existing mounting holes on the appliance flanges. Make sure that the appliance is level before securing it in place.

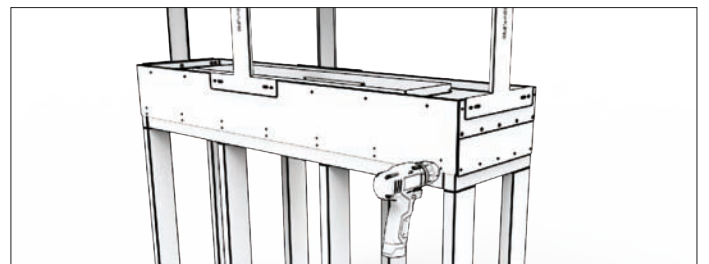

6. Retirez les supports de stabilité rouges.

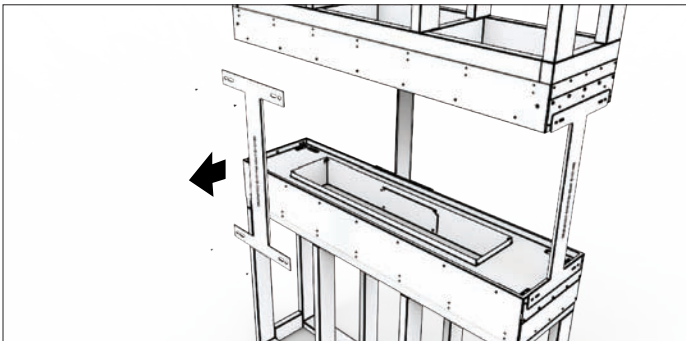

7. Terminez la construction en finissant les panneaux muraux autour de l'insert. (Voir la section **INSTRUCTIONS SUR FINITIONS** et assurez-vous de bien comprendre où les matériaux non combustibles doivent être utilisés.)

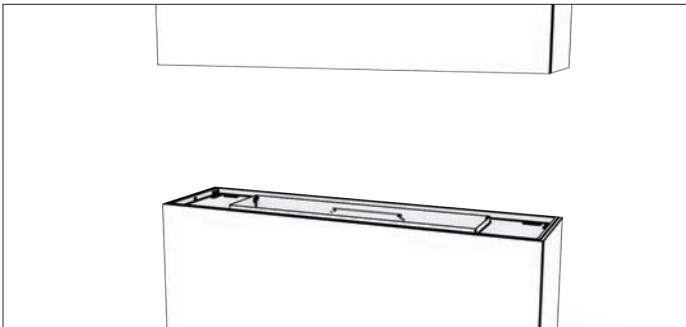

8. Placez le brûleur en position.

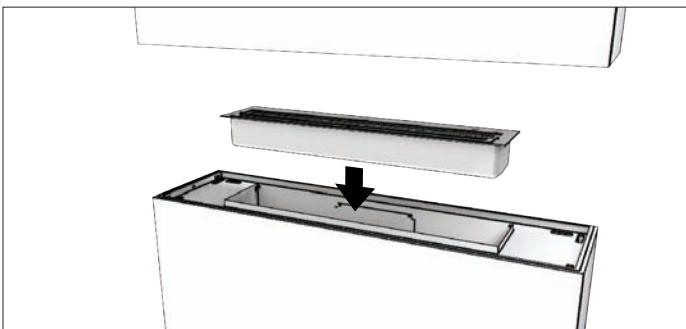

9. Retirez le ruban adhésif anti-poussière qui recouvre les fentes de montage de la vitre de protection.

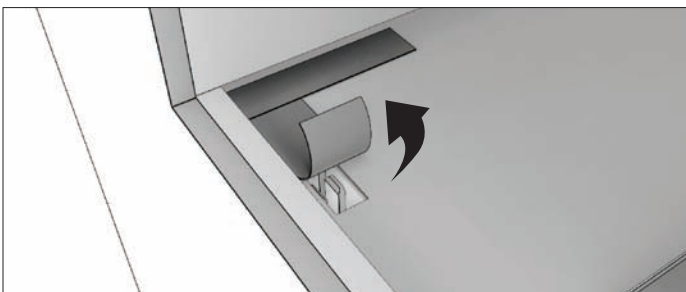

10. Installez la vitre de protection en insérant les deux extrémités dans les fentes appropriées de l'insert. Utilisez un peu de pression pour pousser la vitre de protection en place jusqu'à ce qu'elle glisse dans les clips de verre. Répétez la même opération pour le pare-vent arrière et si votre appareil comprend une boîte décorative à gauche / droite ou les deux.

** Les bûches décoratives ne doivent PAS être mises directement sur une flamme nue. Elles sont conçues pour être placées près de la chaleur mais pas sur la flamme elle-même. Ajoutez un seul jeu de rondins décoratifs à ce modèle.*

ATTENTION: Il s'agit d'un verre trempé - ce qui signifie une meilleure résistance par rapport à un verre normal. Un verre trempé peut toujours potentiellement casser. Les coins et les côtés sont des points de pression spécifiques où le verre est plus fragile et peut se casser en petits morceaux si non protégé. Pour éviter le risque de coupures, nous vous recommandons de porter des gants de protection pendant de la manipulation du verre.

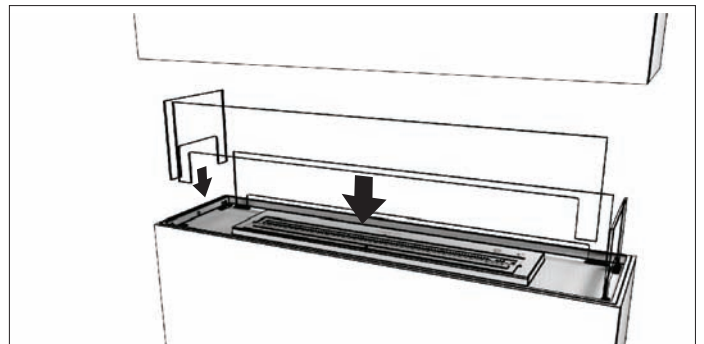

11. Étalez le verre anthracite uniformément autour du plateau de l'insert. **ATTENTION:** Assurez-vous que le couvercle du brûleur soit fermé. Gardez-le verre anthracite à distance de flamme du brûleur pour éviter qu'il atterrisse accidentellement dans la chambre du brûleur. Faites attention à ne pas rayer le brûleur.

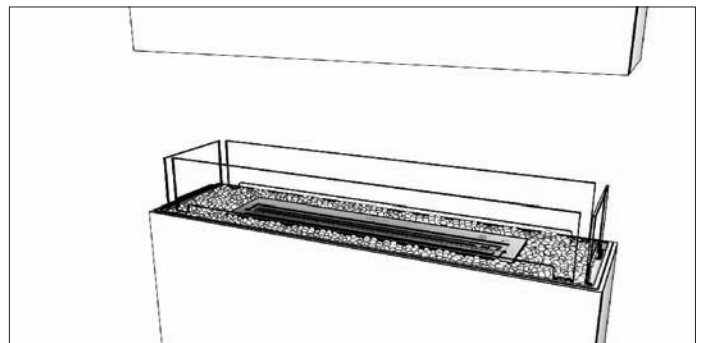

Banc Installation

Matériel nécessaire: Perceuse, Tournevis, Truelle pour le plâtre, Pistolet à silicone, Pistolet à calfeutrer.

1. Construisez la structure principale en utilisant les dimensions indiquées au tableau G. La base du cadre peut être un solide banc / plate-forme, ce qui facilitera la mise à niveau de l'insert lorsqu'il est en position. Lors de la planification de la construction, assurez-vous qu'il y a un dégagement minimum de 1500 mm (59,1") entre l'ouverture du brûleur et le plafond.

ATTENTION: Cet appareil à quatre faces ne peut pas être inséré dans une structure murale. Il doit être installé sur une structure séparée solidement ancrée au sol. N'installez pas sur une structure mobile ou peu solide. Les appareils à quatre faces sont conçus comme des inserts muraux de séparation. Le mur pourrait surchauffer ou s'enflammer si obstrué et non conforme aux instructions d'installation.



Tableau G: Tailles de la structure

Les dimensions du modèle réel devraient être comparées avec les dimensions de la découpe AVANT l'installation finale afin de confirmer l'alignement parfait.

L'INSERT	L mm [in]	P mm [in]	Poids* kg [lbs]
FLEX18BN	455 [17.9]	349 [13.6]	18.3 [40.2]
FLEX32BN	887 [34.9]	349 [13.6]	27.5 [60.6]
FLEX42BN	1142 [45]	349 [13.6]	33.8 [74.4]
FLEX50BN	1347 [53]	349 [13.6]	39.5 [86.9]
FLEX50BN.BX	1347 [53]	349 [13.6]	38.4 [84.5]
FLEX60BN.BX	1602 [63.1]	349 [13.6]	44.7 [98.4]
FLEX68BN	1807 [71.1]	349 [13.6]	50.3 [110.6]
FLEX68BN.BX	1807 [71.1]	349 [13.6]	61.1 [134.5]
FLEX68BN.BX2	1807 [71.1]	349 [13.6]	49.3 [108.5]
FLEX78BN.BX2	2062 [81.2]	349 [13.6]	55.6 [122.4]
FLEX86BN	2267 [89.3]	349 [13.6]	71.6 [157.5]
FLEX86BN.BX	2267 [89.3]	349 [13.6]	61.1 [134.5]
FLEX86BN.BX2	2267 [89.3]	349 [13.6]	61.3 [134.8]
FLEX104BN	2727 [107.4]	349 [13.6]	80 [176]
FLEX104BN.BX	2727 [107.4]	349 [13.6]	82.5 [181.5]
FLEX104BN.BX2	2727 [107.4]	349 [13.6]	72 [158.5]
FLEX122BN	3187 [125.5]	349 [13.6]	105.6 [232.4]
FLEX122BN.BX	3187 [125.5]	349 [13.6]	90.9 [200]
FLEX122BN.BX2	3187 [125.5]	349 [13.6]	93.4 [205.5]
FLEX140BN.BX	3647 [143.6]	349 [13.6]	116.5 [256.3]
FLEX140BN.BX2	3647 [143.6]	349 [13.6]	101.8 [224]
FLEX158BN	4107 [161.7]	349 [13.6]	118.8 [261.4]
FLEX158BN.BX2	4107 [161.7]	349 [13.6]	127.4 [280.3]

* Le poids de l'insert contient le(s) brûleur(s) (poids sec hors carburant), le verre anthracite et le verre. Il ne contient pas de verre anthracite pour les boîtes latérales.

2. Retirez le rebord d'extension du foyer de manière à ce que les deux côtés aient la même hauteur. Cela aidera à faire glisser le foyer dans le cadre plus facilement. Faites attention à ne pas perdre les vis, elles seront nécessaires une fois le rebord réinstallé.

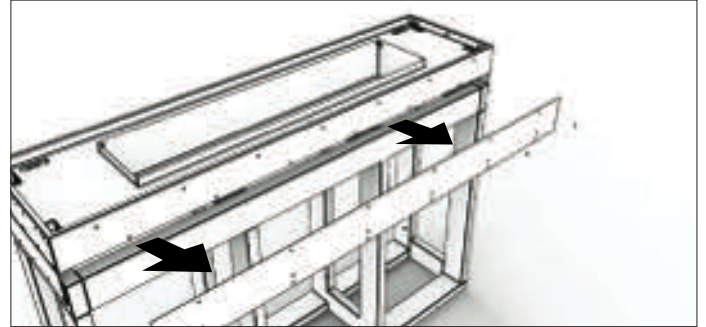

3. Faites glisser l'insert dans la cavité de l'ossature (la base de l'insert peut s'asseoir directement sur le matériau de l'ossature 2 x 4).

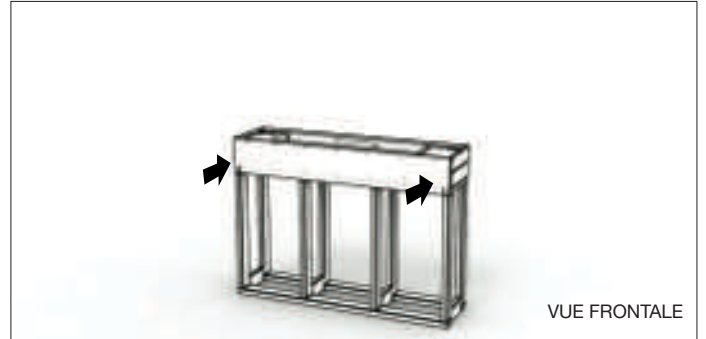

4. Alignez le panneau d'extension du rebord avec les trous filetés de le produit. Vissez-le en place à l'aide de vis (partie inférieure de l'insert, partie supérieure du matériel d'encadrement) pour le fixer en place.

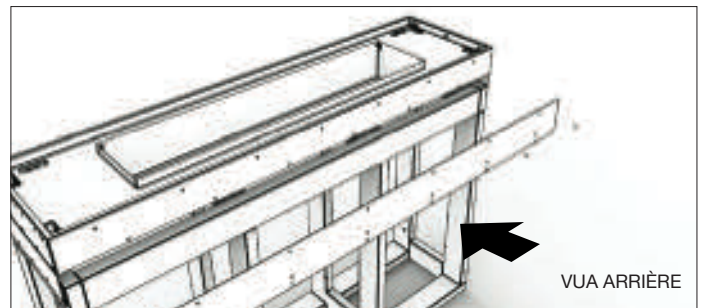

5. Fix the appliance to the framework with screws using the existing mounting holes on the appliance flanges. Make sure that the appliance is level before securing it in place.



Banc Installation

6. Terminez la construction en finissant les panneaux muraux autour de l'insert.
(Voir la section **INSTRUCTIONS SUR FINITIONS** et assurez-vous de bien comprendre où les matériaux non combustibles doivent être utilisés.)



7. Placez le brûleur en position.

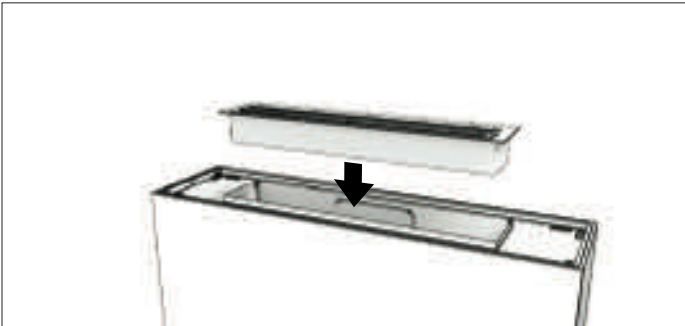

8. Retirez le ruban adhésif anti-poussière qui recouvre les fentes de montage de la vitre de protection.

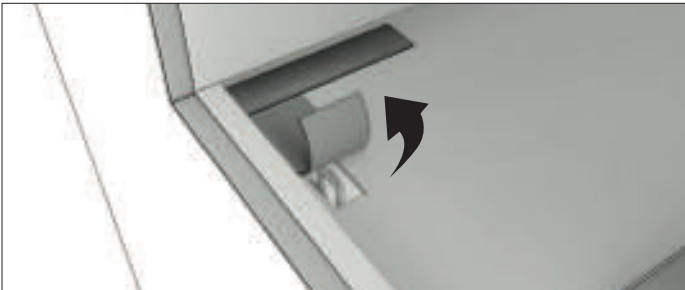

9. Installez la vitre de protection en insérant les deux extrémités dans les fentes appropriées de l'insert. Utilisez un peu de pression pour pousser la vitre de protection en place jusqu'à ce qu'elle glisse dans les clips de verre. Répétez la même opération pour le pare-vent arrière et si votre appareil comprend une boîte décorative à gauche / droite ou les deux.

**Decorative logs must NOT be placed directly over an open flame. They are designed to sit near heat but not over flames. Ajoutez un seul jeu de rondins décoratifs à ce modèle.*

ATTENTION: Il s'agit d'un verre trempé - ce qui signifie une meilleure résistance par rapport à un verre normal. Un verre trempé peut toujours potentiellement casser. Les coins et les côtés sont des points de pression spécifiques où le verre est plus fragile et peut se casser en petits morceaux si non protégé. Pour éviter le risque de coupures, nous vous recommandons de porter des gants de protection pendant de la manipulation du verre.

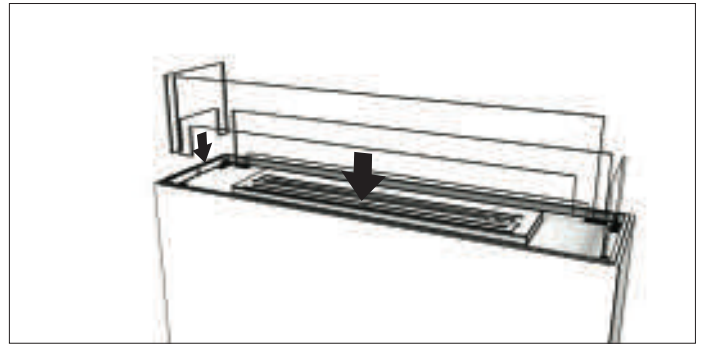

10. Étalez le verre anthracite uniformément autour du plateau de l'insert.
ATTENTION: Assurez-vous que le couvercle du brûleur soit fermé. Gardez-le verre anthracite à distance de flamme du brûleur pour éviter qu'il atterrisse accidentellement dans la chambre du brûleur. Faites attention à ne pas rayer le brûleur.



1. Appliquez panneaux muraux. Les matériaux acceptables comprennent les panneaux de fibrociment, les panneaux de fibres à densité moyenne à indice de résistance au feu (FR MDF), la pierre, le carrelage, l'acier et les plaques de plâtre à indice de résistance au feu (FR).

Les matériaux de finitions ne doivent jamais déborder sur l'ouverture de l'insert.

ATTENTION: Risque d'incendie! Ne pas appliquer de matériaux combustibles au-delà des dégagements minimaux. Veuillez respecter les distances minimales du plus proche combustible spécifiées dans ce manuel et dans le manuel du brûleur.

IMPORTANT: Un panneau 155 mm [6"] non-combustible doit être installé au-dessus tous les côtés de l'ouverture de l'insert.

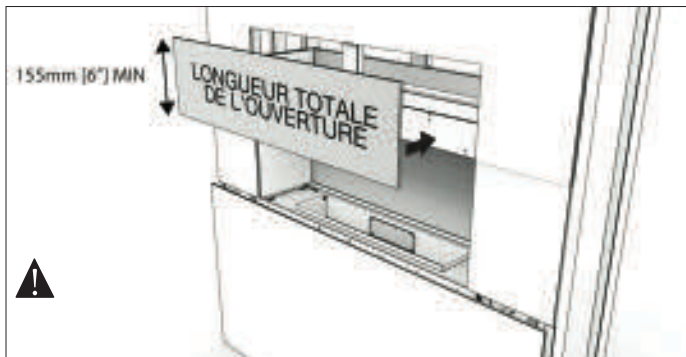

Exemple: Cheminee Simple Face



Exemple: Cheminee Peninsula

2. Une bordure de finition en métal DOIT être installée sur tous les bords (couper les angles en onglet). (N'utilisez pas de longues attaches plus épaisses que le matériau des panneaux muraux pour éviter de pénétrer dans l'insert).

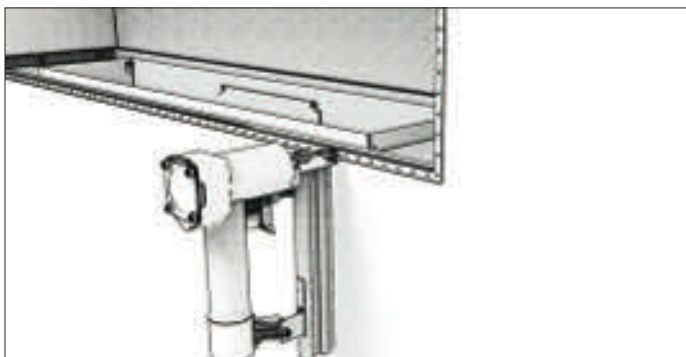

3. Plâtrer tous les joints et bordures.

Tout les joints entre le revêtement de la finition murale et le devant de l'insert doivent être scellés avec des matériaux non combustibles. Les produits d'étanchéité, tels que le mastic ou le mastic utilisé pour sceller l'espace entre le mur et l'insert doivent être résistants à une exposition de chaleur continue minimale de 150 ° C (122 ° F).

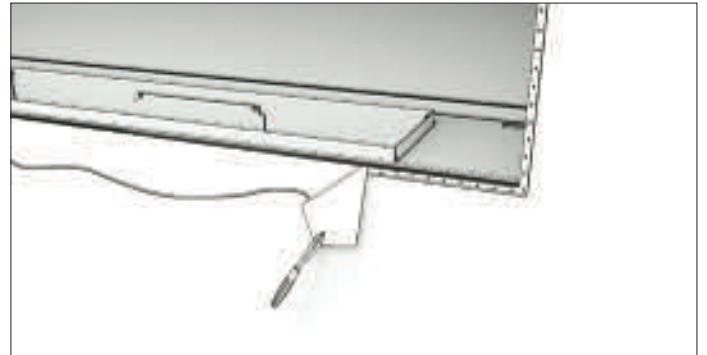

4. Si la finition souhaitée contient un mur peint, du latex 100% acrylique, des acryliques à base d'huile ou des acryliques standard peuvent être utilisés. Suivez les instructions du fabricant de peinture pour l'application de peinture et d'apprêt.

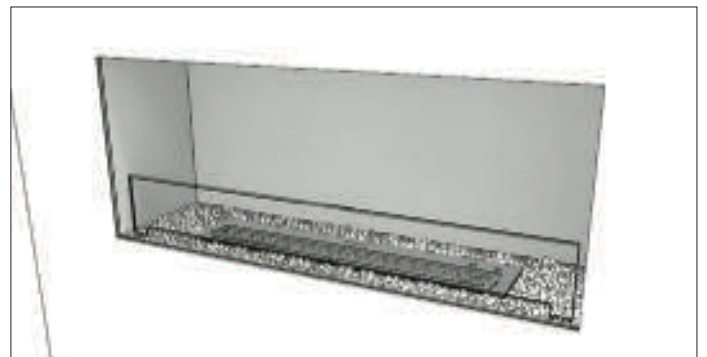

UTILISEZ L'INSERT EN ACCORDANCE AVEC LE MANUEL FOURNIS AVEC LE BRÛLEUR.

TABLETTE DE CHEMINÉE

PLAQUE DE REMPLISSAGE DE BOÎTE DÉCORATIVE

60

Dégagements minimaux

Si le décor contient une tablette de cheminée, les dimensions verticales et horizontales maximales de la tablette combustible identifiées dans l'image ci-dessous doivent être respectées.

Distance Minimale du plus proche COMBUSTIBLE

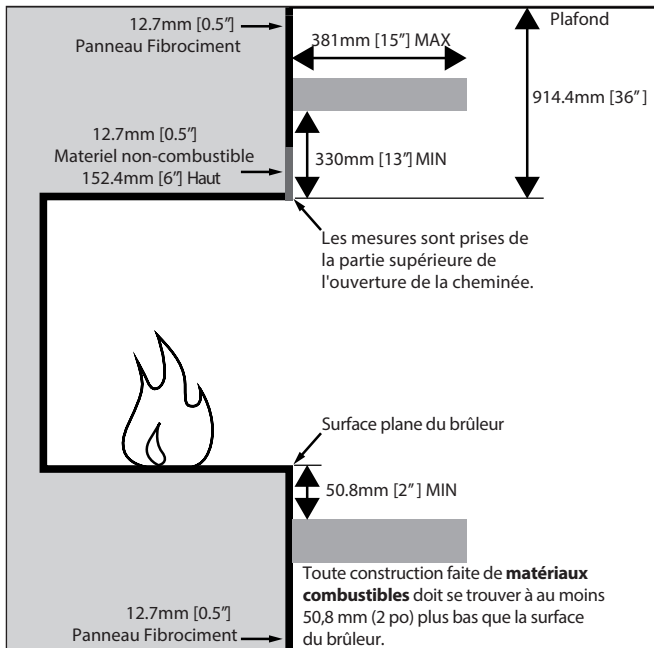

Dimensions minimales verticales et maximales horizontales de la tablette combustible.

Finitions et dégagements des matériaux NON COMBUSTIBLES

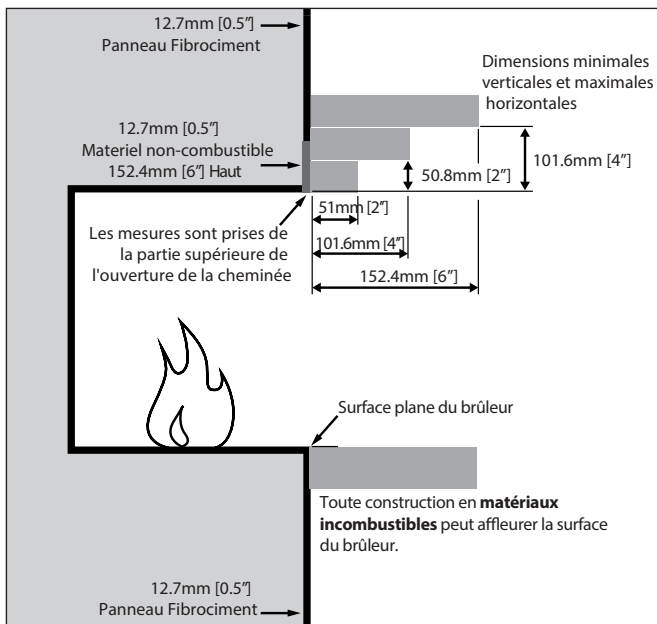

Dimensions minimales verticales et maximales horizontales de la tablette non-combustible.

ATTENTION: Risque d'incendie! Respectez tous les dégagements minimaux des plus proche combustibles tels que spécifiés dans ce manuel. Encadrement ou matériaux de finition plus proche que les distances minimales indiquées doivent être construites entièrement avec uniquement des matériaux non combustibles.

Pour le produit avec une boîte décorative sur un côté, une plaque de remplissage est prévu pour soulever le matériau afin de l'aligner avec le bord inférieur de l'insert. Les boîte decorative doit seulement être utilisé pour tenir des accessoires/matériel non combustible.

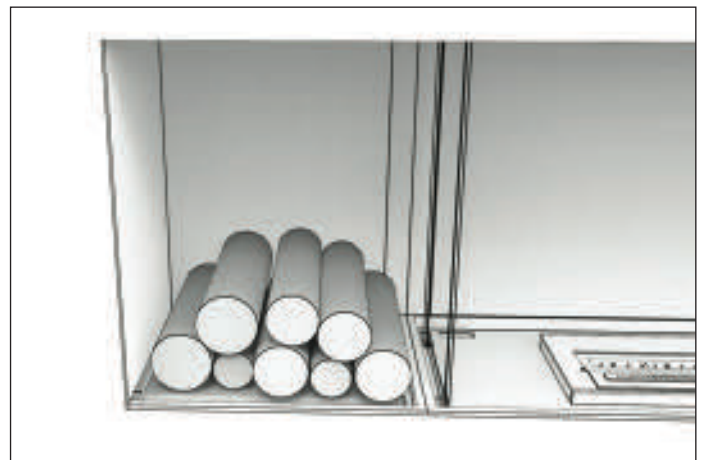
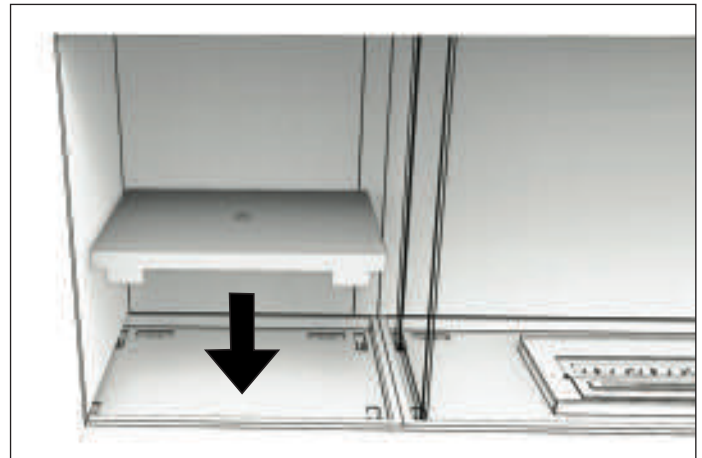

Pour le produit avec une boîte décorative sur un côté, une plaque de remplissage est prévu pour soulever le matériau afin de l'aligner avec le bord inférieur de l'insert. Les boîte decorative doit seulement être utilisé pour tenir des accessoires/matériel non combustible.

Des bûches décoratives en acier sont disponibles comme accessoire optionnel. Contactez customerservice@ecosmartfire.com

* Les bûches décoratives ne doivent PAS être mis directement sur une flamme ouvert. Ils sont conçus pour s'asseoir près de la chaleur mais pas sur les flammes.

壁炉预留间隙

选择壁炉安装位置	62
通风注意事项	62
最小室内面积要求	62

壁炉安装

外框	63
准备工作	64
Single Sided 单面壁炉安装	65 - 66
Left Corner 左面壁炉安装	67 - 68
Right Corner 右面壁炉安装	67 - 68
BAY 前环绕型壁炉安装	69 - 70
DOUBLE Sided 双面壁炉安装	71 - 72
PENINSULA 侧环绕型壁炉安装	73 - 74
ISLAND 悬浮式壁炉安装	75 - 76
BENCH 中岛型壁炉安装	77 - 78
墙体安装	79
壁炉面饰	80
装饰盒内托盘	80

此壁炉仅适用于使用UL认证的火炉产品

使用方式

请参考附带的燃烧器使用说明书

壁炉预留间隙

请在安装使用EcoSmart Fire®的产品前，仔细阅读说明书以确保产品在最安全的状态下使用。

选择壁炉安装的位置

壁炉为外墙体无间隙设计，以及预留了足够的安全空间以隔离房屋内以建好的可燃外框架等材质。壁炉是特别针对EcoSmart 燃烧器所设计研发。

在选取安装壁炉位置时，请了解清楚最小室内面积要求以及与墙壁，可燃物的安全距离。（请参照以下安全距离指示图与最小安全间距表格）。

注意：Flex壁炉是采用黑色高温塑粉上色至镀锌板材质上起到最佳防锈效果。燃烧器是使用304不锈钢材质制作。为了更好的保养与长久使用燃烧器，请及时清理表面的污渍与污垢。

如果壁炉安装至户外环境，请确保壁炉的正上方有防护屋檐以防止雨水浸泡侵蚀导致产品彻底无法使用。如果产品在曝露的环境下使用将会导致失去产品维修的权利。

在未使用的情况下，请确保火炉的盖子关上以预防任何外来物件嵌入或污染燃烧器炉芯。

注意：烧伤隐患！请预留足够多的开口让空气流通以及方便后续保养。请参照此壁炉与燃烧器说明书内推荐的与可燃物安全距离。确保任何时候火焰的位置都必须远离一切可燃材质。因为壁炉会产生高温热量，请将壁炉安置在远离人群常行走区域，以及家具与干货。也请注意任何可能因为避风导致挪动，晃动的物件，例如树叶，树枝，窗帘，纸等。当正在使用燃烧器，或燃烧器刚使用仍残留余温的状态下，请看管好儿童避免儿童靠近壁炉导致烧伤。

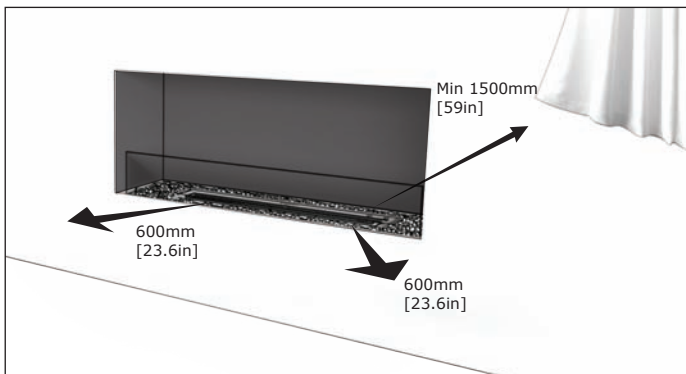

室内间距

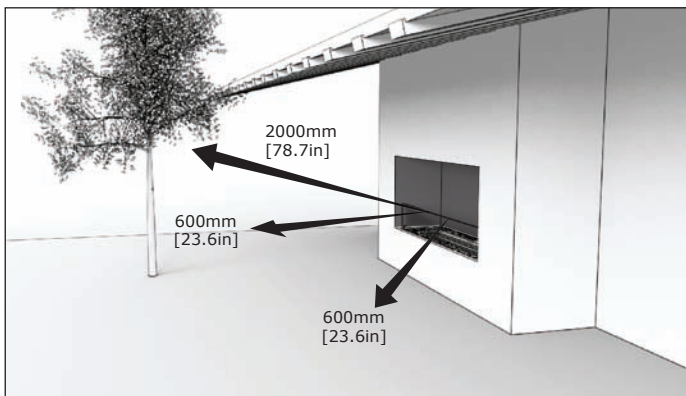

户外间距（需涵盖屋檐以确保雨水不会浸湿燃烧器。与当地政府核实是否安装环境在政府的认证编号里。）

通风注意事项

EcoSmart Fires® 无需任何固定夹具或配件用于通风，以及燃料供给。

请勿覆盖现有的通风系统设计或预留的壁炉安装空间。

请勿覆盖现有的通风系统设计或预留的壁炉安装空间。

为确保足够的通风环境，请参照以下表格的标准。

美国保险商试验所 (UL) 根据以下计算方式判定是否有足够的通风环境：

传统的房屋结构，不含高密封，密集型房屋设计结构的，足够的空气流通需要能与户外接通。不过，如果壁炉在小于5.7立方米【200ft³】的环境内使用的话，在燃烧器最大功率状态下，每小时最大热量值需在1000BTU内，需保持门与对接房间保持空气通畅，或是预留窗户缝隙至少25.4mm [1in]以防止室内缺氧等空气问题发生。请勿在狭小的空间内与浴室内安装壁炉。

最小室内面积要求

通风要求的表格是根据不同型号的燃烧器测量。

壁炉	燃烧器	最小室内空间面积	BTU
FLEX18	1x AB3	1413 立方英尺 (40 立方米)	5,800
FLEX32 FLEX50.BX FLEX68.BX2	1x XL500	2825 立方英尺 (80 立方米)	11,430
FLEX42 FLEX60.BX FLEX78.BX2	1x XL700	3178 立方英尺 (90 立方米)	13,650
FLEX50 FLEX68.BX FLEX86.BX2	1x XL900	3884 立方英尺 (110 立方米)	15,000
FLEX68 FLEX86.BX FLEX104.BX2	1x XL1200	4061 立方英尺 (115 立方米)	16,200
FLEX86 FLEX104.BX FLEX122.BX2	2x XL900	7768 立方英尺 (220 立方米)	30,000
FLEX104 FLEX122.BX FLEX140.BX2	2x XL1200	8122 立方英尺 (230 立方米)	32,400
FLEX122 FLEX140.BX FLEX158.BX2	3x XL900	11652 立方英尺 (330.2 立方米)	45,000
FLEX158	3x XL1200	12183 立方英尺 (345 立方米)	48,600

此壁炉不适用于大型供热系统

壁炉的主要设计用途用于辅助供热以及室内装饰效果。不应考量为家用整屋供热系统。

壁炉应在安全安装固定牢固的位置操作使用。

注意：请勿安装靠近壁画，壁纸，贴纸或是任何不能耐热耐高温的表面（因为热量会导致材质变质，或是特定情况下溶解材质内的胶水导致脱胶）。壁炉周边的环境会变热，所以对于温度敏感的材质请勿在壁炉周围使用。请勿将可燃材质放置壁炉周围。

壁炉不可用作隔门，或是活动隔间的用途。

任何时候壁炉必须保持通风。壁炉不可用作烤箱，或是类似保温箱的用途。壁炉在使用时火焰必须有足够空气流通达到最佳的燃烧效果。

请勿在壁炉与框架预留的位置内（壁炉与隔离柱之间）塞入隔热板材或是其他材质。预留空间是用于维持产品正常散热与使用。

在任何安装的情况下，请勿私自修改产品。不允许切割产品的金属板。

产品在使用时或使用后因为升温或降温产生的轻微异响属于正常现象。

注意：请勿在无玻璃的情况下使用。

请在使用前确保壁炉完整组装好。如果未能按照要求安装玻璃（或移除玻璃）或是使用非认证的燃烧器将会导致保修资格取消。

框架

框架安装注意事项

1. 壁炉必须安装至平整表面以达到最佳支撑效果用于支撑壁炉，燃烧器，玻璃石以及酒精溶液。
2. 壁炉安装指导尺寸为最佳尺寸方便壁炉组装进墙体后上石膏板等外墙材质。
3. 安装位置的准备工作。如果壁炉建立在平台表面上，请确保平台材质的使用与设计考量能承重壁炉，燃烧器，玻璃石以及燃烧器内满酒精状态的总重量。安装前请确保平台的表面处于水平状态。

注意：框架设计与组装时要确保框架的整体结构处于平衡耐压状态。壁炉本身结构不能承重框架等壁炉主体外的重量。

注释

可燃材质 - 木制或表面木制，压缩纸，纤维，塑料，或是其他易燃物质，涵盖任何会因加热而损坏或着火的材质，石膏或非石膏，非自燃等都需考虑为可燃材质。

材料不可烧的定义为合金，铁，红砖，瓷砖，水泥，石板，玻璃与石膏，或任何混合材料。例如HardieBacker®, WonderBoard®, Durock® 或是通过ASTM E 136 认证的材质，以及立体方形壁炉内750度下测试通过的材质均为非可燃性材质。

注意：示意图为常规安装方法仅用作设计参考用途。示意图未按比例绘画。实际安装情况也请根据个人设计方案考量与达到我们要求的安全标准。

使用前须知

1. 请小心拆开包装与挪动壁炉与配件。
2. 仔细检查包装内的任何零件是否有受损，请特别注意挡风玻璃。
3. 仔细阅读说明书与安装要求。按照指示的步骤仔细安装检查以确保产品在最佳与安全的状态下使用。

警告：火灾与爆炸的安全隐患！配件损坏会影响产品的安全性。如发现，请勿继续安装损坏配件或替换未认证配件。

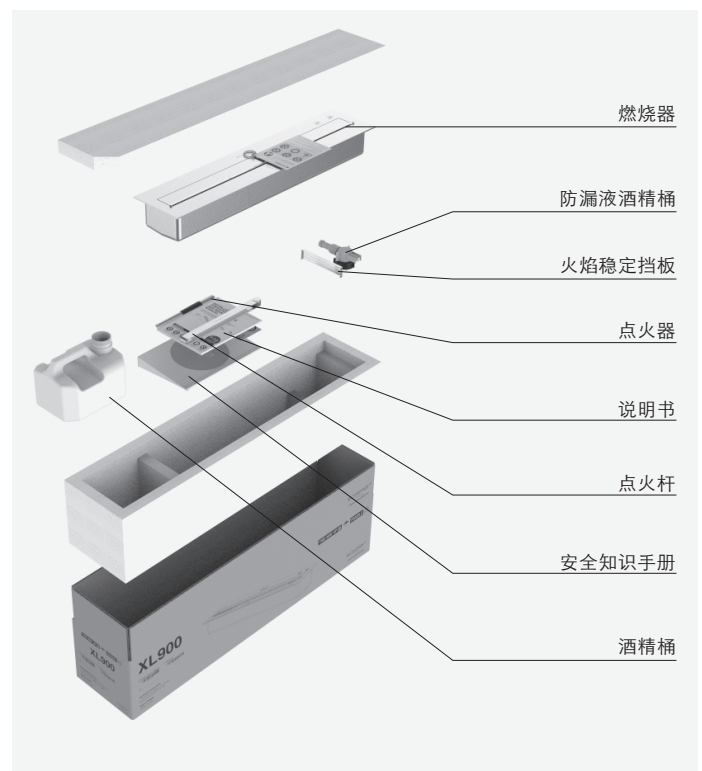
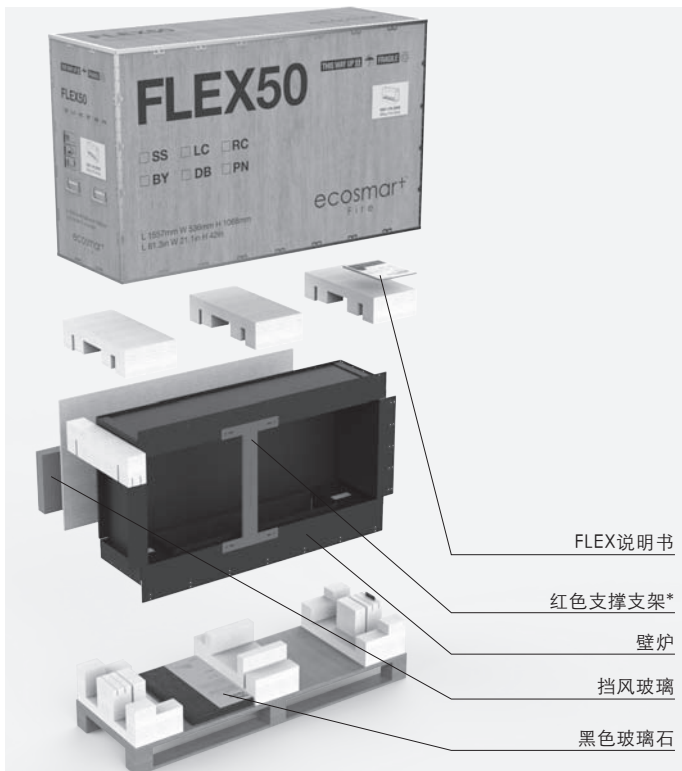

Single Sided 单面壁炉安装

准备工具：电钻，螺丝刀，石膏瓦刀，硅胶，填缝枪。

1. 根据表格A的开口尺寸搭建框架。底座可以为实心平整的平台以方便校正壁炉的水平线。



表格A：框架开口尺寸。

请实际测量壁炉规格先以确保制作框架前考量足够公差。

壁炉	宽 mm [in]	深 mm [in]	高 mm [in]	重量* kg [lbs]
FLEX18SS	488 [19.2]	365 [14.4]	730 [28.7]	25.7 [56.5]
FLEX32SS	922 [36.3]	365 [14.4]	730 [28.7]	45.7 [100.5]
FLEX42SS	1177 [46.3]	365 [14.4]	730 [28.7]	60 [131.9]
FLEX50SS	1380 [54.3]	365 [14.4]	730 [28.7]	71.4 [157.1]
FLEX50SS.BX	1380 [54.3]	365 [14.4]	730 [28.7]	69.9 [153.8]
FLEX60SS.BX	1634 [64.3]	365 [14.4]	730 [28.7]	83.9 [184.6]
FLEX68SS	1840 [72.4]	365 [14.4]	730 [28.7]	97.1 [213.6]
FLEX68SS.BX	1840 [72.4]	365 [14.4]	730 [28.7]	95.1 [209.2]
FLEX68SS.BX2	1840 [72.4]	365 [14.4]	730 [28.7]	93.9 [206.7]
FLEX78SS.BX2	2090 [82.3]	365 [14.4]	730 [28.7]	107.8 [237.1]
FLEX86SS	2300 [90.5]	365 [14.4]	730 [28.7]	121.5 [267.3]
FLEX86SS.BX	2300 [90.5]	365 [14.4]	730 [28.7]	119.4 [262.7]
FLEX86SS.BX2	2300 [90.5]	365 [14.4]	730 [28.7]	118.8 [261.4]
FLEX104SS	2760 [108.7]	365 [14.4]	730 [28.7]	146.2 [321.6]
FLEX104SS.BX	2760 [108.7]	365 [14.4]	730 [28.7]	145.2 [319.4]
FLEX104SS.BX2	2760 [108.7]	365 [14.4]	730 [28.7]	193.8 [426.4]
FLEX122SS	3220 [126.7]	365 [14.4]	730 [28.7]	171.5 [377.3]
FLEX122SS.BX	3220 [126.7]	365 [14.4]	730 [28.7]	170.1 [374.2]
FLEX122SS.BX2	3220 [126.7]	365 [14.4]	730 [28.7]	168.9 [371.6]
FLEX140SS.BX	3680 [144.9]	365 [14.4]	730 [28.7]	195.2 [429.4]
FLEX140SS.BX2	3680 [144.9]	365 [14.4]	730 [28.7]	193.8 [426.4]
FLEX158SS	4140 [163]	365 [14.4]	730 [28.7]	222.1 [488.6]
FLEX158SS.BX2	4140 [163]	365 [14.4]	730 [28.7]	218.9 [481.6]

* 壁炉重量包含壁炉（无酒精状态），玻璃石。不包含装饰盒内的玻璃石。

注意：在壁炉上方的框架必须能承载自重与保持结构稳定。因为壁炉本身非结构支撑设计不能承载除了燃烧器等附带配件以外的重量。

2. 将壁炉滑进框架的腔体内（壁炉可以直接架在2x4板材的框架上）。壁炉内以预先安装了红色支撑支架在壁炉的开口处以保护在运输与安装过程中不会变形。请将保留红色支撑支架直到框架安装结束为止。

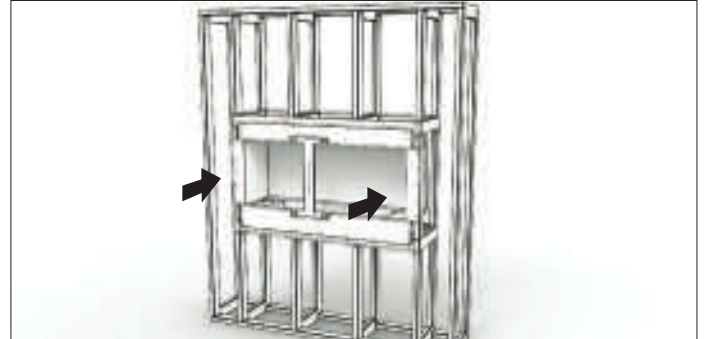

3. 请用螺丝透过壁炉预留的组装口固定壁炉至框架上。锁紧前请确保壁炉处于水平状态。

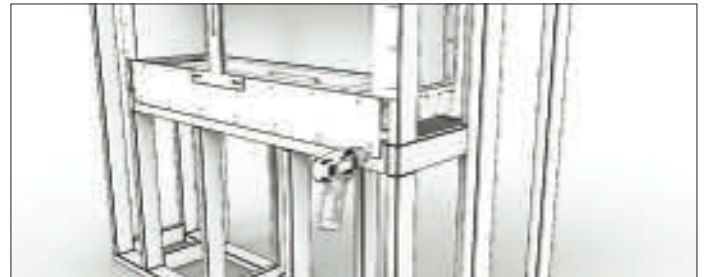

4. 移除红色支撑支架。

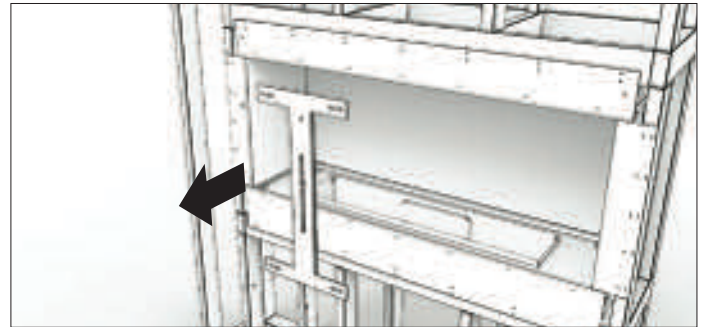

Single Sided 单面壁炉安装

5. 请使用防火墙板包裹住壁炉墙体内的表面。（请参照表面完工指示确保完全理解与使用非可燃性材质安装。）

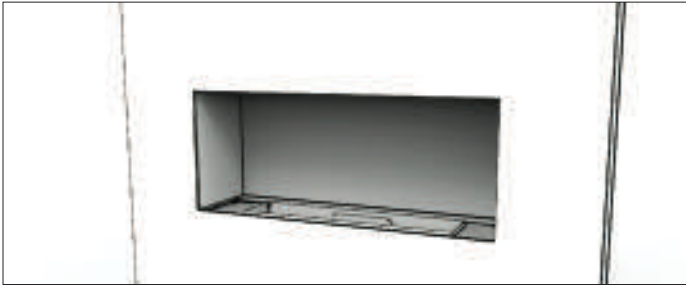

6. 将燃烧器放入壁炉内。



7. 移除玻璃安装孔的防尘贴纸。

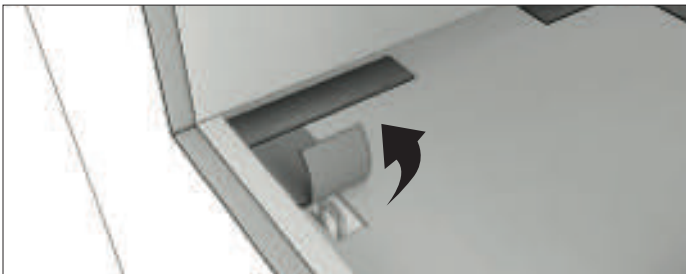

8. 如果壁炉附带了左/右侧装饰盒，请将内玻璃往上插入顶端洞口然后在摆正放低进预留的玻璃孔位。

*装饰铁管请勿直接放置在火焰燃烧的位置。装饰铁盒仅用于美观用途。

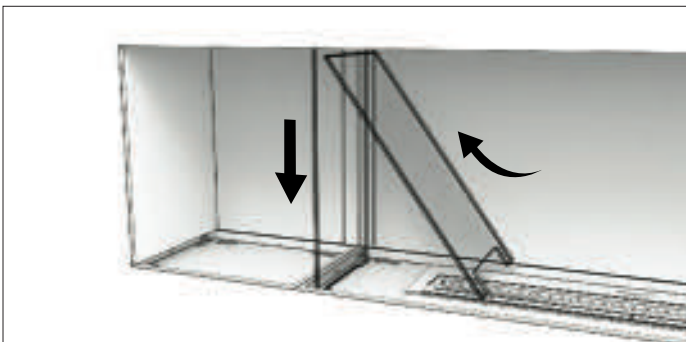

9. 对准预留的两端玻璃孔洞安装挡风玻璃。请使用适当的力度将挡风玻璃推入玻璃夹处固定。

注意：挡风玻璃为钢化玻璃，比常规玻璃在耐温与结构上要强硬。但是钢化玻璃也有脆弱的位置，特别在角落与边缘处如果不小心照料，在特定压力下受损或受压会导致玻璃破裂。我们推荐您在安装时请配套手套以防止玻璃破裂时细小的碎片刮伤。

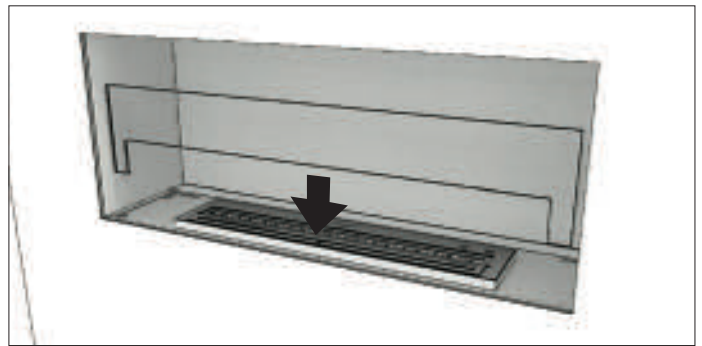

10. 均匀摊开摆放玻璃石进壁炉内。注意：确保燃烧器的炉盖是关闭的。请避免摆放在燃烧器靠近炉芯口的地方以预防掉入。摆放时请注意不要刮伤燃烧器表面。

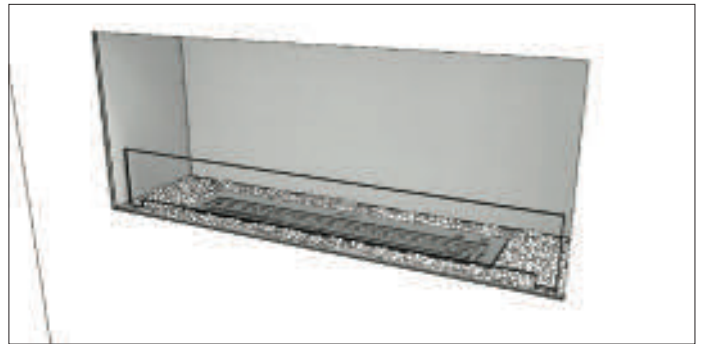

Left Corner & Right Corner

左/右面壁炉安装

准备工具：电钻，螺丝刀，石膏瓦刀，硅胶，填缝枪。

1. 根据表格B的开口尺寸搭建框架。底座可以为实心平整的平台以方便校正壁炉的水平线。
示意图为左面壁炉安装。



表格B：框架开口尺寸。

请实际测量壁炉规格先以确保制作框架前考量足够公差。

壁炉 (LC & RC)	宽 mm [in]	深 mm [in]	高 mm [in]	重量* kg [lbs]
FLEX18LC	470 [18.5]	365 [14.4]	730 [28.7]	33 [72.6]
FLEX32LC	902 [35.5]	365 [14.4]	730 [28.7]	48.8 [107.4]
FLEX42LC	1157 [45.5]	365 [14.4]	730 [28.7]	63.3 [139.3]
FLEX50LC	1362 [53.6]	365 [14.4]	730 [28.7]	71.6k [157.5]
FLEX50LC.BX	1362 [53.6]	365 [14.4]	730 [28.7]	73.1 [160.8]
FLEX60LC.BX	1617 [63.7]	365 [14.4]	730 [28.7]	87.1 [191.6]
FLEX68LC	1822 [71.7]	365 [14.4]	730 [28.7]	100.3 [220.7]
FLEX68LC.BX	1822 [71.7]	365 [14.4]	730 [28.7]	95.3 [209.7]
FLEX68LC.BX2	1822 [71.7]	365 [14.4]	730 [28.7]	97kg [213.4]
FLEX78LC.BX2	2077 [81.8]	365 [14.4]	730 [28.7]	111 [244.2]
FLEX86LC	2282 [89.8]	365 [14.4]	730 [28.7]	121.7 [267.7]
FLEX86LC.BX	2282 [89.8]	365 [14.4]	730 [28.7]	122.6 [269.7]
FLEX86LC.BX2	2282 [89.8]	365 [14.4]	730 [28.7]	119 [261.8]
FLEX104LC	2742 [107.9]	365 [14.4]	730 [28.7]	149.5 [328.9]
FLEX104LC.BX	2742 [107.9]	365 [14.4]	730 [28.7]	145.4 [319.9]
FLEX104LC.BX2	2742 [107.9]	365 [14.4]	730 [28.7]	146.9 [323.2]
FLEX122LC	3202 [126.1]	365 [14.4]	730 [28.7]	171.7 [377.7]
FLEX122LC.BX	3202 [126.1]	365 [14.4]	730 [28.7]	173.4 [381.5]
FLEX122LC.BX2	3202 [126.1]	365 [14.4]	730 [28.7]	169.1 [372]
FLEX140LC.BX	3662 [144.2]	365 [14.4]	730 [28.7]	197.1 [433.6]
FLEX140LC.BX2	3662 [144.2]	365 [14.4]	730 [28.7]	195.4 [429.9]
FLEX158LC	4122 [162.3]	365 [14.4]	730 [28.7]	225.5 [496.1]
FLEX158LC.BX2	4122 [162.3]	365 [14.4]	730 [28.7]	219.1 [482]

* 壁炉重量包含壁炉（无酒精状态），玻璃石。不包含装饰盒内的玻璃石。

注意：在壁炉上方的框架必须能承载自重与保持结构稳定。因为壁炉本身非结构支撑设计不能承载除了燃烧器等附带配件以外的重量。

2. 将壁炉滑进框架的腔体内（壁炉可以直接架在2x4板材的框架上）。壁炉内以预先安装了红色支撑支架在壁炉的开口处以保护在运输与安装过程中不会变形。请将保留红色支撑支架直到框架安装结束为止。使用附带的螺丝对准顶部的角落延长板锁紧壁炉顶板。

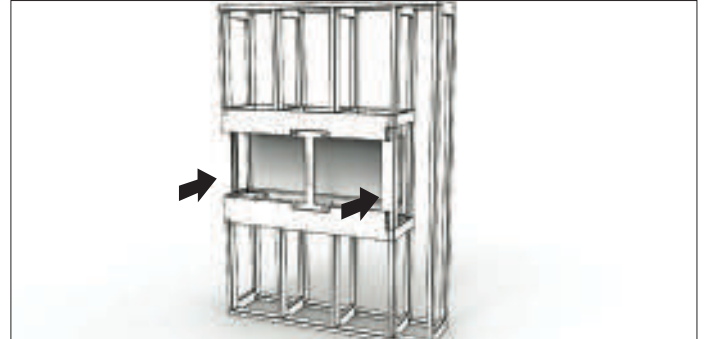

3. 请用螺丝透过壁炉预留的组装口固定壁炉至框架上。锁紧前请确保壁炉处于水平状态。



4. 移除红色支撑支架。

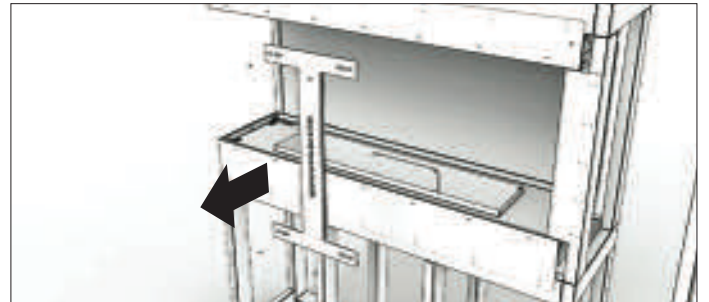

5. 请使用防火墙板包裹住壁炉墙体内的表面。（请参照表面完工指示确保完全理解与使用非可燃性材质安装。）



Left Corner & Right Corner 左/右面壁炉安装

6. 将燃烧器放入壁炉内。

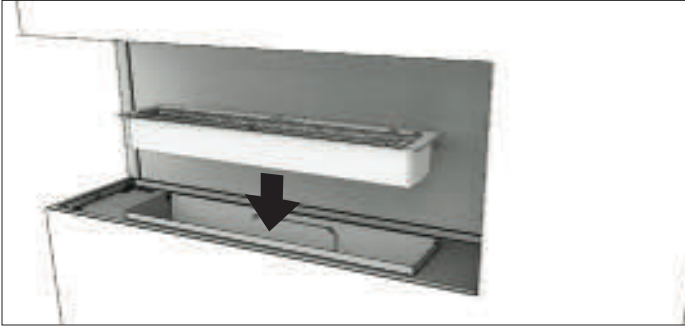

7. 移除玻璃安装孔的防尘贴纸。

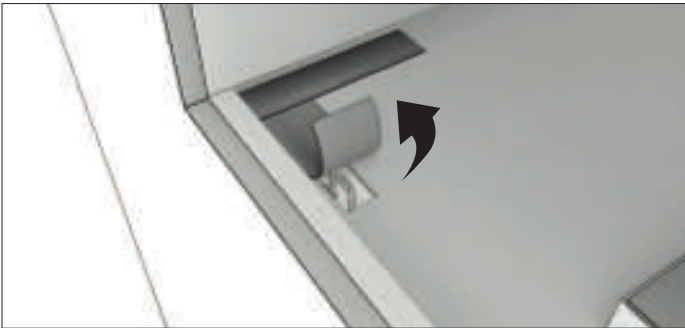

8. 如果壁炉附带了左/右侧装饰盒，请将内玻璃往上插入顶端洞口然后在摆正放低进预留的玻璃孔位。

*装饰铁管请勿直接放置在火焰燃烧的位置。装饰铁盒仅用于美观用途。

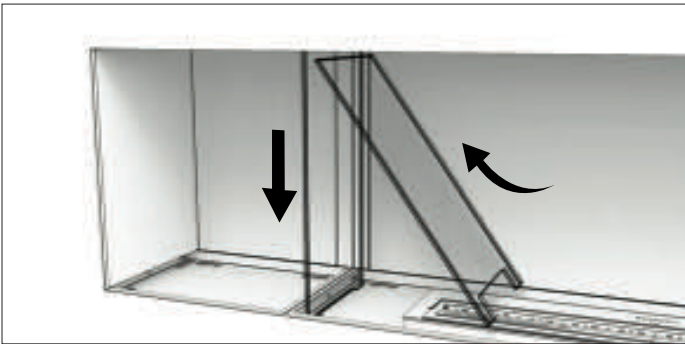

9. 将侧边玻璃透过顶部开口插入然后摆正并将玻璃脚的位置放低安装进底座预留的玻璃夹固定紧。



10. 对准预留的两端玻璃孔洞安装挡风玻璃。请使用适当的力度将挡风玻璃推入玻璃夹处固定。

注意：挡风玻璃为钢化玻璃，比常规玻璃在耐温与结构上要强硬。但是钢化玻璃也有脆弱的位置，特别在角落与边缘处如果不小心照料，在特定压力下受损或受压会导致玻璃破裂。我们推荐您在安装时请配套手套以防止玻璃破裂时细小的碎片刮伤。

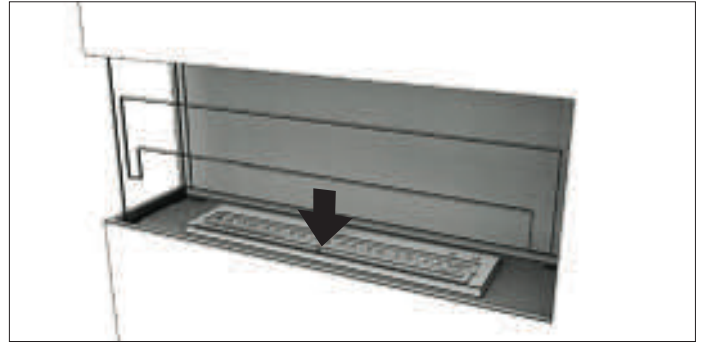

11. 均匀摊开摆放玻璃石进壁炉内。注意：确保燃烧器的炉盖是关闭的。请避免摆放在燃烧器靠近炉芯口的地方以防掉入。摆放时请注意不要刮伤燃烧器表面。

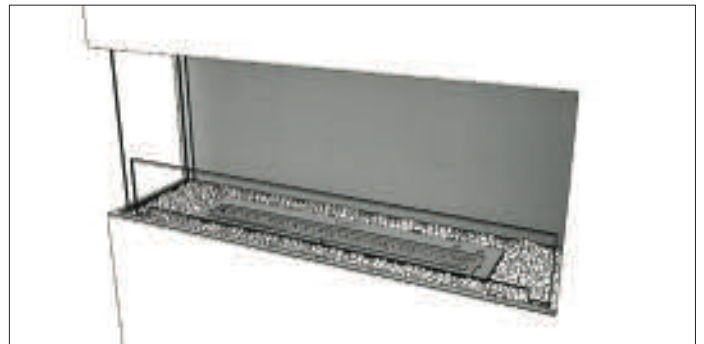

Bay

前环绕型壁炉安装

准备工具：电钻，螺丝刀，石膏瓦刀，硅胶，填缝枪。

1. 根据表格C的开口尺寸搭建框架。底座可以为实心平整的平台以方便校正壁炉的水平线。



表格C：框架开口尺寸。

请实际测量壁炉规格先以确保制作框架前考量足够公差。

壁炉	宽 mm [in]	深 mm [in]	高 mm [in]	重量* kg [lbs]
FLEX18BY	460 [18.1]	365 [14.4]	730 [28.7]	40.7 [89.5]
FLEX32BY	892 [35.1]	365 [14.4]	730 [28.7]	51.9 [114.2]
FLEX42BY	1147 [45.2]	365 [14.4]	730 [28.7]	66.5 [146.3]
FLEX50BY	1352 [53.2]	365 [14.4]	730 [28.7]	71.8 [158]
FLEX50BY.BX	1353 [53.3]	365 [14.4]	730 [28.7]	76.2 [167.6]
FLEX60BY.BX	1608 [63.3]	365 [14.4]	730 [28.7]	90.3 [198.7]
FLEX68BY	1813 [71.4]	365 [14.4]	730 [28.7]	103.6 [227.9]
FLEX68BY.BX	1813 [71.4]	365 [14.4]	730 [28.7]	95.5 [210.1]
FLEX68BY.BX2	1813 [71.4]	365 [14.4]	730 [28.7]	100.2 [220.4]
FLEX78BY.BX2	2068 [81.4]	365 [14.4]	730 [28.7]	114 [250.8]
FLEX86BY	2272 [89.4]	365 [14.4]	730 [28.7]	121.9 [268.2]
FLEX86BY.BX	2272 [89.4]	365 [14.4]	730 [28.7]	125.9 [277]
FLEX86BY.BX2	2272 [89.4]	365 [14.4]	730 [28.7]	119.2 [262.2]
FLEX104BY	2733 [107.6]	365 [14.4]	730 [28.7]	152.9 [336.4]
FLEX104BY.BX	2733 [107.6]	365 [14.4]	730 [28.7]	145.6 [320.3]
FLEX104BY.BX2	2733 [107.6]	365 [14.4]	730 [28.7]	150.1 [330.2]
FLEX122BY	3193 [125.7]	365 [14.4]	730 [28.7]	171.9 [378.2]
FLEX122BY.BX	3193 [125.7]	365 [14.4]	730 [28.7]	176.7 [388.7]
FLEX122BY.BX2	3193 [125.7]	365 [14.4]	730 [28.7]	169.3 [372.5]
FLEX140BY.BX	3653 [143.8]	365 [14.4]	730 [28.7]	195.6 [430.3]
FLEX140BY.BX2	3653 [143.8]	365 [14.4]	730 [28.7]	200.3 [440.7]
FLEX158BY	4113 [161.9]	365 [14.4]	730 [28.7]	228.8 [503.4]
FLEX158BY.BX2	4113 [161.9]	365 [14.4]	730 [28.7]	219.3 [482.5]

* 壁炉重量包含壁炉（无酒精状态），玻璃石。不包含装饰盒内的玻璃石。

注意：在壁炉上方的框架必须能承载自重与保持结构稳定。因为壁炉本身非结构支撑设计不能承载除了燃烧器等附带配件以外的重量。

2. 将壁炉滑进框架的腔体内（壁炉可以直接架在2x4板材的框架上）。壁炉内以预先安装了红色支撑支架在壁炉的开口处以保护在运输与安装过程中不会变形。请将保留红色支撑支架直到框架安装结束为止。

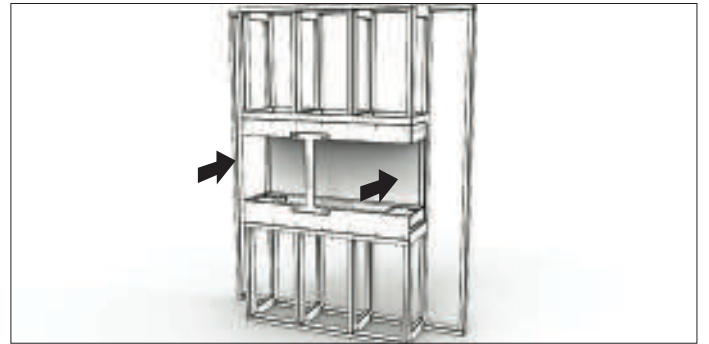

3. 确保左右边缘与框架持平。

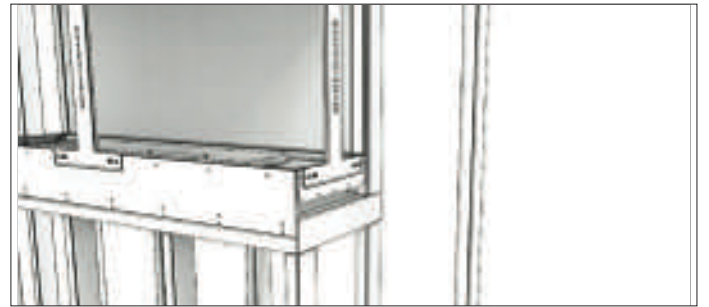

4. 请用螺丝透过壁炉预留的组装口固定壁炉至框架上。锁紧前请确保壁炉处于水平状态。

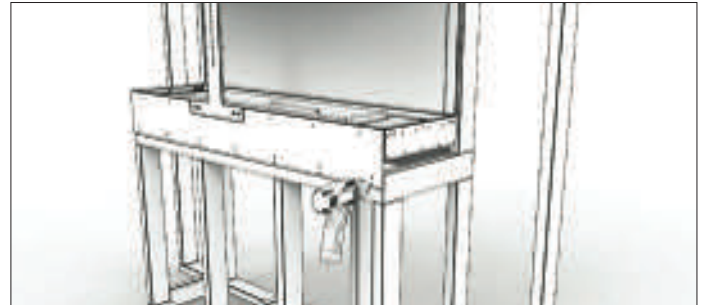

5. 移除红色支撑支架。

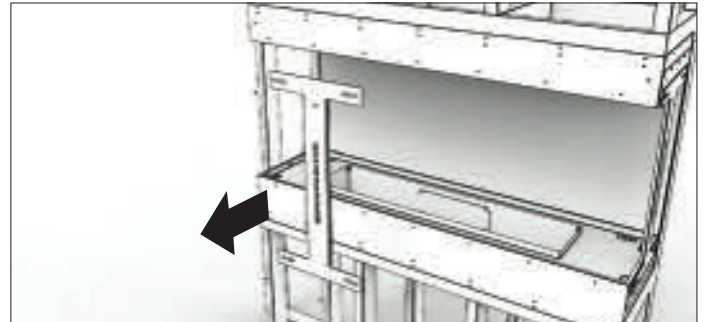

Bay

前环绕型壁炉安装

70

6. 请使用防火墙板包裹住壁炉墙体内的表面。（请参照表面完工指示确保完全理解与使用非可燃性材质安装。）

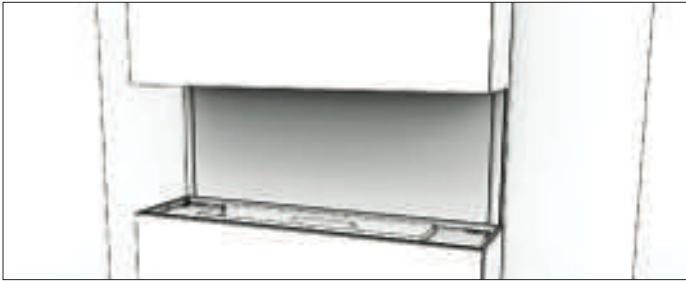

7. 将燃烧器放入壁炉内。

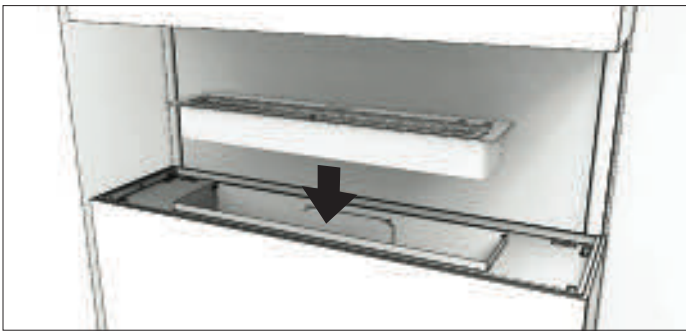

8. 移除玻璃安装孔的防尘贴纸。

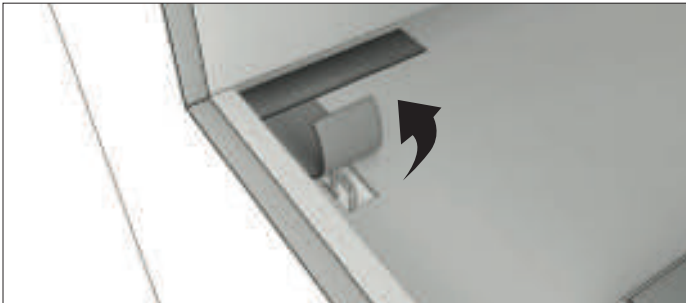

9. 如果壁炉附带了左/右侧装饰盒，请将内玻璃往上插入顶端洞口然后在摆正放进预留的玻璃孔位。

*装饰铁管请勿直接放置在火焰燃烧的位置。装饰铁盒仅用于美观用途。

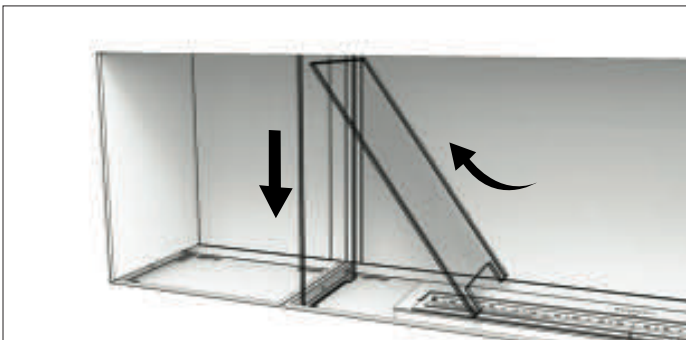

10. 将侧边玻璃透过顶部开口插入然后摆正并将玻璃脚的位置放低安装进底座预留的玻璃夹固定紧。

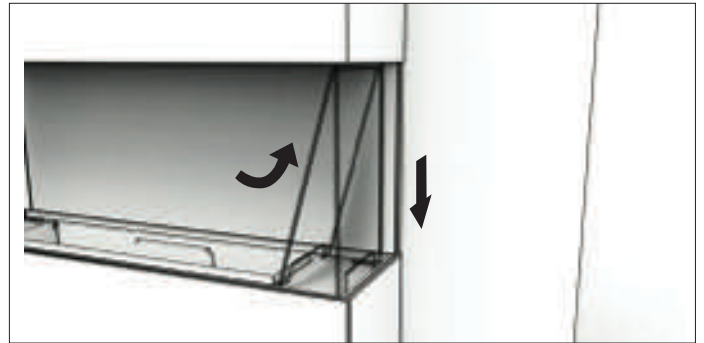

11. 对准预留的两端玻璃孔洞安装挡风玻璃。请使用适当的力度将挡风玻璃推入玻璃夹处固定。

注意：挡风玻璃为钢化玻璃，比常规玻璃在耐温与结构上要强硬。但是钢化玻璃也有脆弱的位置，特别在角落与边缘处如果不小心照料，在特定压力下受损或受压会导致玻璃破裂。我们推荐您在安装时请配套手套以防止玻璃破裂时细小的碎片刮伤。

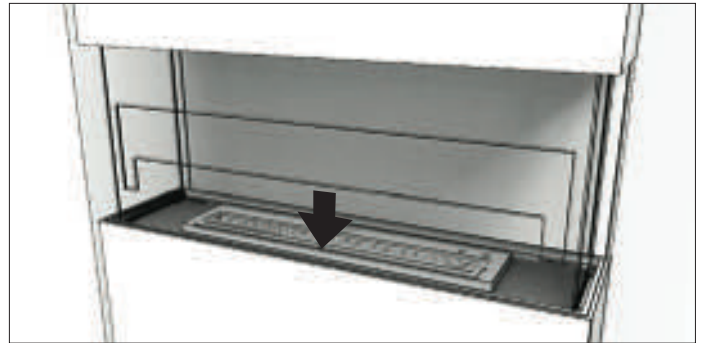

12. 均匀摊开摆放玻璃石进壁炉内。注意：确保燃烧器的炉盖是关闭的。请避免摆放在燃烧器靠近炉芯口的地方以防掉入。摆放时请注意不要刮伤燃烧器表面。

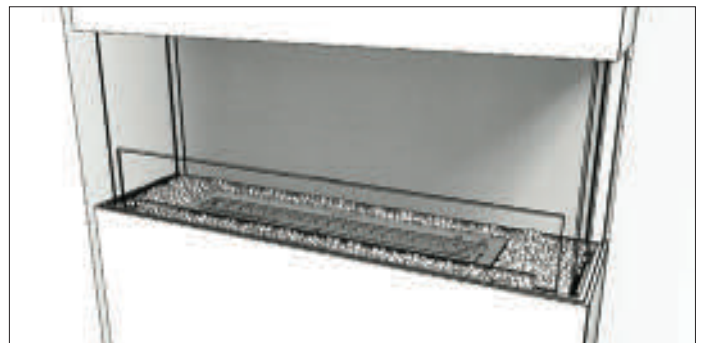

Double Sided

双面壁炉安装

准备工具：电钻，螺丝刀，石膏瓦刀，硅胶，填缝枪。

1. 根据表格D的开口尺寸搭建框架。底座可以为实心平整的平台以方便校正壁炉的水平线。

注意：双面壁炉不能装入单面腔体内。安装框架必须为双向的，前后玻璃均无任何物体遮挡。请勿施加任何压力在材料与玻璃上。双向壁炉为空间分隔用途。如果不谨慎参考安装指示，墙体或因过热而着火。



表格D：框架开口尺寸。

请实际测量壁炉规格先以确保制作框架前考量足够公差。

壁炉	宽 mm [in]	深 mm [in]	高 mm [in]	重量* kg [lbs]
FLEX18DB	488 [19.2]	349 [13.6]	730 [28.7]	26.5 [58.3]
FLEX32DB	922 [36.3]	349 [13.6]	730 [28.7]	46.6 [102.5]
FLEX42DB	1177 [46.3]	349 [13.6]	730 [28.7]	61.4 [135.1]
FLEX50DB	1380 [54.3]	349 [13.6]	730 [28.7]	70.8 [155.8]
FLEX50DB.BX	1380 [54.3]	349 [13.6]	730 [28.7]	70 [154]
FLEX60DB.BX	1634 [64.3]	349 [13.6]	730 [28.7]	83.3 [183.3]
FLEX68DB	1840 [72.4]	349 [13.6]	730 [28.7]	95.5 [210.1]
FLEX68DB.BX	1840 [72.4]	349 [13.6]	730 [28.7]	83.7 [184.1]
FLEX68DB.BX2	1840 [72.4]	349 [13.6]	730 [28.7]	94.8 [208.6]
FLEX78DB.BX2	2090 [82.3]	349 [13.6]	730 [28.7]	106.2 [233.6]
FLEX86DB	2300 [90.5]	349 [13.6]	730 [28.7]	102.3 [225.1]
FLEX86DB.BX	2300 [90.5]	349 [13.6]	730 [28.7]	124.5 [273.9]
FLEX86DB.BX2	2300 [90.5]	349 [13.6]	730 [28.7]	108.5 [238.7]
FLEX104DB	2760 [108.7]	349 [13.6]	730 [28.7]	145.7 [320.5]
FLEX104DB.BX	2760 [108.7]	349 [13.6]	730 [28.7]	127.1 [279.6]
FLEX104DB.BX2	2760 [108.7]	349 [13.6]	730 [28.7]	142 [312]
FLEX122DB	3220 [126.7]	349 [13.6]	730 [28.7]	145.6 [320.3]
FLEX122DB.BX	3220 [126.7]	349 [13.6]	730 [28.7]	170.1 [374.2]
FLEX122DB.BX2	3220 [126.7]	349 [13.6]	730 [28.7]	151.9 [334.2]
FLEX140DB.BX	3680 [144.9]	349 [13.6]	730 [28.7]	170.4 [374.9]
FLEX140DB.BX2	3680 [144.9]	349 [13.6]	730 [28.7]	192.9 [424.4]
FLEX158DB	4140 [163]	349 [13.6]	730 [28.7]	226.8 [499]
FLEX158DB.BX2	4140 [163]	349 [13.6]	730 [28.7]	195.2 [429.4]

* 壁炉重量包含壁炉（无酒精状态），玻璃石。不包含装饰盒内的玻璃石。

注意：在壁炉上方的框架必须能承载自重与保持结构稳定。因为壁炉本身非结构支撑设计不能承载除了燃烧器等附带配件以外的重量。

2. 移除背面的延长板背板与侧板持平以方便将壁炉滑进框架内。请保管卸下后的螺丝。

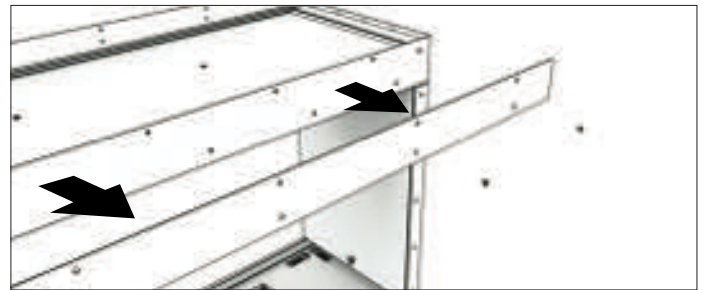

3. 将壁炉滑进框架的腔体内（托盘的底部可以直接架在框架上安装）。壁炉内以预先安装了红色支撑支架在壁炉的开口处以保护在运输与安装过程中不会变形。请将保留红色支撑支架直到框架安装结束为止。

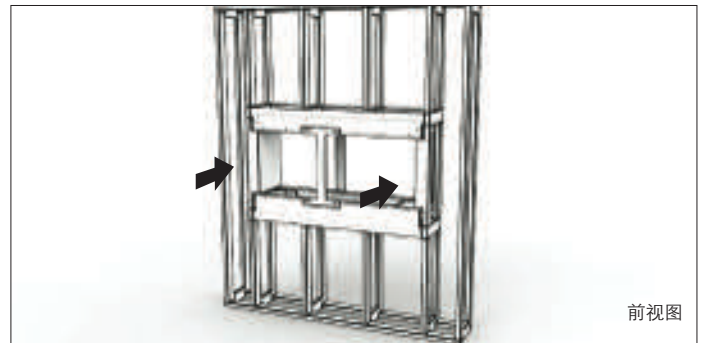

4. 对齐延长板的孔位，使用附带的螺丝安装至壁炉上并与框架固定牢固。



5. 请用螺丝透过壁炉预留的组接口固定壁炉至框架上。锁紧前请确保壁炉处于水平状态。

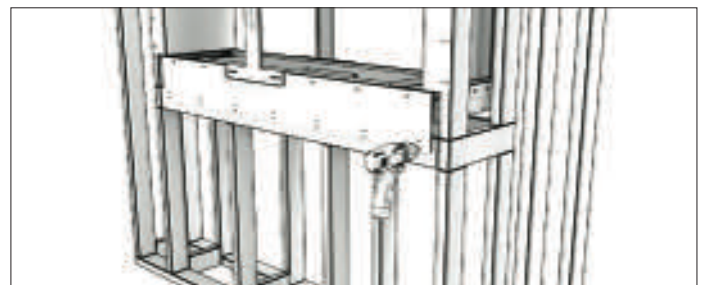

Double Sided 双面壁炉安装

6. 移除红色支撑支架。

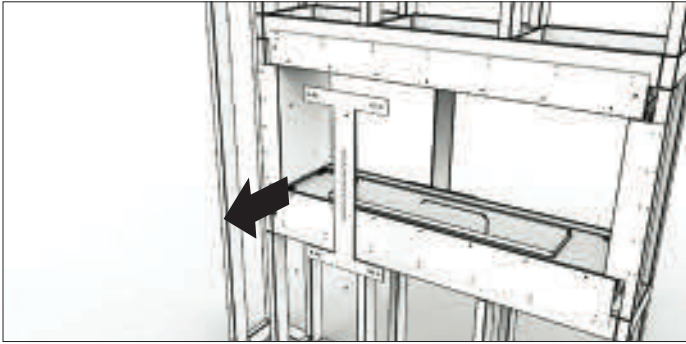

7. 请使用防火墙板包裹住壁炉墙体内的表面。（请参照表面完工指示确保完全理解与使用非可燃性材质安装。）

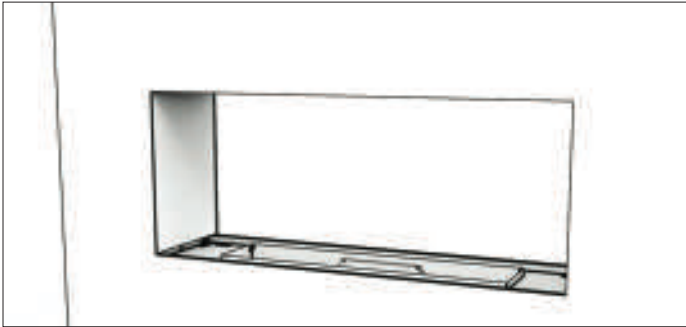

8. 将燃烧器放入壁炉内。

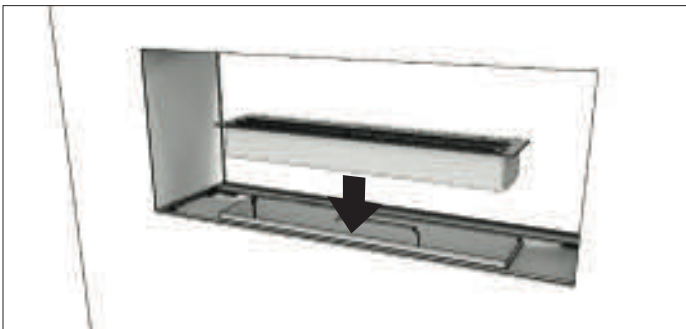

9. 移除玻璃安装孔的防尘贴纸。

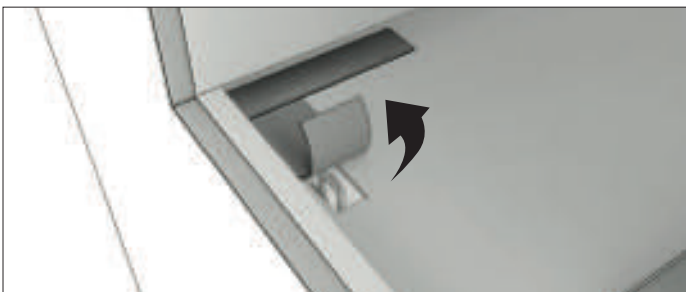

10. 如果壁炉附带了左/右侧装饰盒，请将内玻璃往上插入顶端洞口然后在摆正放低进预留的玻璃孔位。

*装饰铁管请勿直接放置在火焰燃烧的位置。装饰铁盒仅用于美观用途。

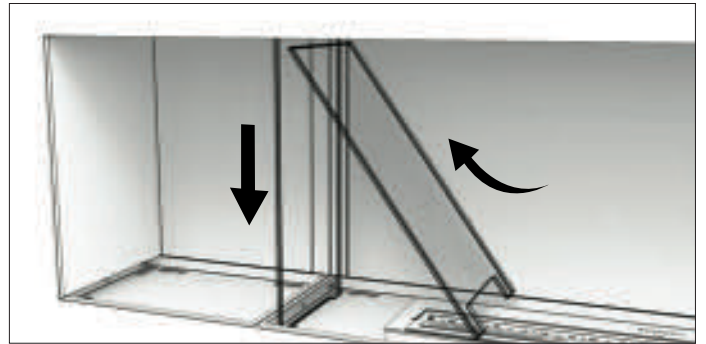

11. 对准预留的两端玻璃孔洞安装挡风玻璃。请使用适当的力度将挡风玻璃推入玻璃夹处固定。

注意：挡风玻璃为钢化玻璃，比常规玻璃在耐温与结构上要强硬。但是钢化玻璃也有脆弱的位置，特别在角落与边缘处如果不小心照料，在特定压力下受损或受压会导致玻璃破裂。我们推荐您在安装时请配套手套以防止玻璃破裂时细小的碎片刮伤。

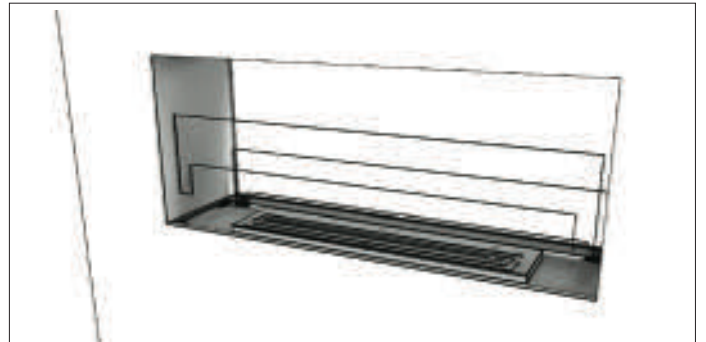

12. 均匀摊开摆放玻璃石进壁炉内。注意：确保燃烧器的炉盖是关闭的。请避免摆放在燃烧器靠近炉芯口的地方以防掉入。摆放时请注意不要刮伤燃烧器表面。

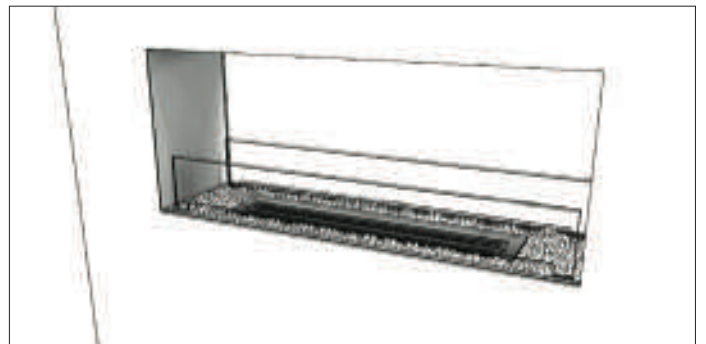

Peninsula

侧环绕型壁炉安装

准备工具：电钻，螺丝刀，石膏瓦刀，硅胶，填缝枪。

1. 根据表格E的开口尺寸搭建框架。底座可以为实心平整的平台以方便校正壁炉的水平线。

注意：三面敞开壁炉不能装入单面腔体内。安装框架必须为三面通畅的，前后玻璃均无任何物体遮挡。请勿施加任何压力在材料与玻璃上。三面敞开壁炉为空间分隔用途。如果不谨慎参考安装指示，墙体或因过热而着火。



表格E：框架开口尺寸。

请实际测量壁炉规格先以确保制作框架前考量足够公差。

壁炉	宽 mm [in]	深 mm [in]	高 mm [in]	重量* kg [lbs]
FLEX18PN	470 [18.5]	349 [13.6]	730 [28.7]	34.2 [75.2]
FLEX32PN	902 [35.5]	349 [13.6]	730 [28.7]	49.8 [109.6]
FLEX42PN	1157 [45.5]	349 [13.6]	730 [28.7]	64.7 [142.3]
FLEX50PN	1362 [53.6]	349 [13.6]	730 [28.7]	59.1 [130]
FLEX50PN.BX	1362 [53.6]	349 [13.6]	730 [28.7]	73.2 [161]
FLEX60PN.BX	1617 [63.7]	349 [13.6]	730 [28.7]	87.5 [192.5]
FLEX68PN	1822 [71.7]	349 [13.6]	730 [28.7]	102.8 [226.2]
FLEX68PN.BX	1822 [71.7]	349 [13.6]	730 [28.7]	83.9 [184.6]
FLEX68PN.BX2	1822 [71.7]	349 [13.6]	730 [28.7]	96.1 [211.4]
FLEX78PN.BX2	2077 [81.8]	349 [13.6]	730 [28.7]	110.4 [242.9]
FLEX86PN	2282 [89.8]	349 [13.6]	730 [28.7]	102.5 [225.5]
FLEX86PN.BX	2282 [89.8]	349 [13.6]	730 [28.7]	124.1 [273]
FLEX86PN.BX2	2282 [89.8]	349 [13.6]	730 [28.7]	108.7 [239.1]
FLEX104PN	2742 [107.9]	349 [13.6]	730 [28.7]	153.3 [337.3]
FLEX104PN.BX	2742 [107.9]	349 [13.6]	730 [28.7]	127.3 [280.1]
FLEX104PN.BX2	2742 [107.9]	349 [13.6]	730 [28.7]	147.3 [324.1]
FLEX122PN	3202 [126.1]	349 [13.6]	730 [28.7]	145.8 [320.8]
FLEX122PN.BX	3202 [126.1]	349 [13.6]	730 [28.7]	176.2 [387.6]
FLEX122PN.BX2	3202 [126.1]	349 [13.6]	730 [28.7]	152.1 [334.6]
FLEX140PN.BX	3662 [144.2]	349 [13.6]	730 [28.7]	170.6 [375.3]
FLEX140PN.BX2	3662 [144.2]	349 [13.6]	730 [28.7]	198.7 [437.1]
FLEX158PN	4122 [162.3]	349 [13.6]	730 [28.7]	231.8 [510]
FLEX158PN.BX2	4122 [162.3]	349 [13.6]	730 [28.7]	195.4 [429.9]

* 壁炉重量包含壁炉（无酒精状态），玻璃石。不包含装饰盒内的玻璃石。

注意：在壁炉上方的框架必须能承载自重与保持结构稳定。因为壁炉本身非结构支撑设计不能承载除了燃烧器等附带配件以外的重量。

2. 移除背面的延长板背板与侧板持平以方便将壁炉滑进框架内。请保管卸下后的螺丝。

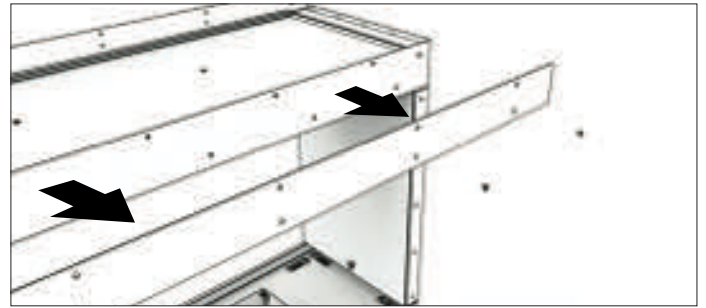

3. 将壁炉滑进框架的腔体内（托盘的底部可以直接架在框架上安装）。壁炉内以预先安装了红色支撑支架在壁炉的开口处以保护在运输与安装过程中不会变形。请将保留红色支撑支架直到框架安装结束为止。

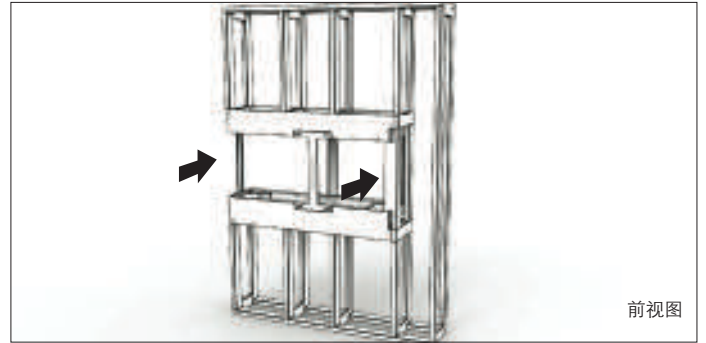

4. 确保壁炉的开口面的边缘与框架边缘组装后持平。

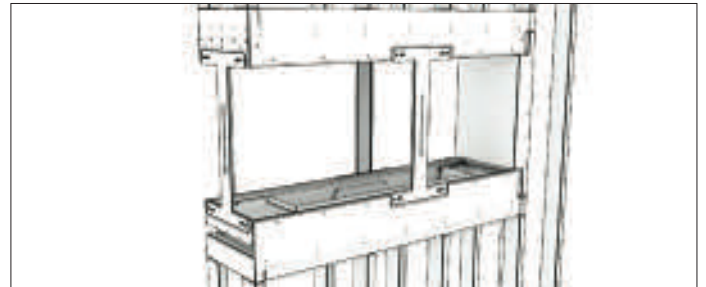

5. 对齐延长板的孔位，使用自带的螺丝安装至壁炉上并与框架固定牢固。



Peninsula

侧环绕型壁炉安装

6. 请用螺丝透过壁炉预留的组装口固定壁炉至框架上。锁紧前请确保壁炉处于水平状态。

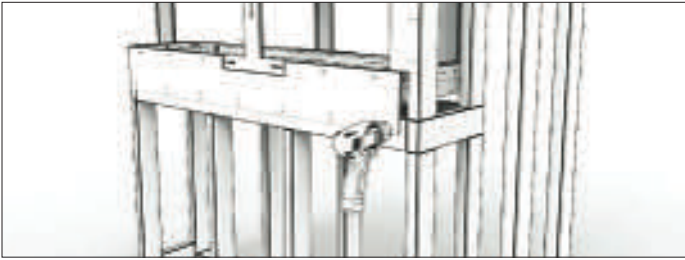

7. 移除红色支撑支架。



8. 请使用防火墙板包裹住壁炉墙体内的表面。（请参照表面完工指示确保完全理解与使用非可燃性材质安装。）



9. 将燃烧器放入壁炉内。

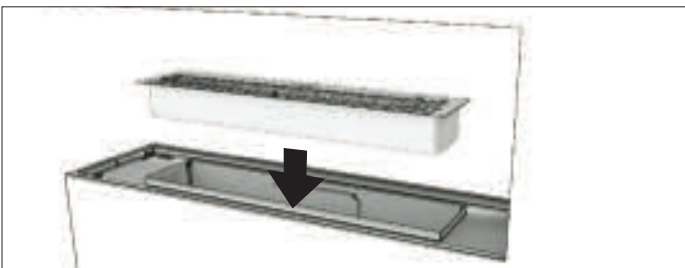

10. 移除玻璃安装孔的防尘贴纸。

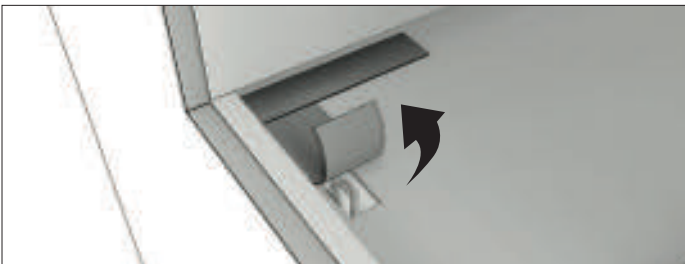

11. 如果壁炉附带了左/右侧装饰盒，请将内玻璃往上插入顶端洞口然后在摆正放低进预留的玻璃孔位。

*装饰铁管请勿直接放置在火焰燃烧的位置。装饰铁盒仅用于美观用途。

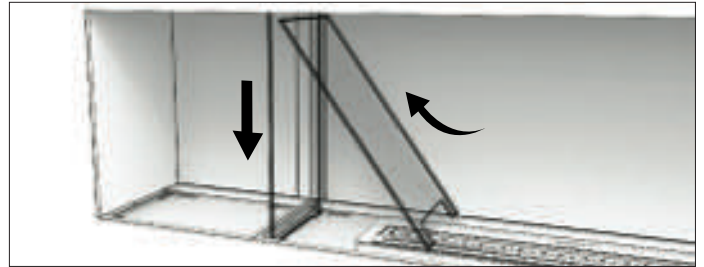

12. 将侧边玻璃透过顶部开口插入然后摆正并将玻璃脚的位置放低安装进底座预留的玻璃夹固定紧。

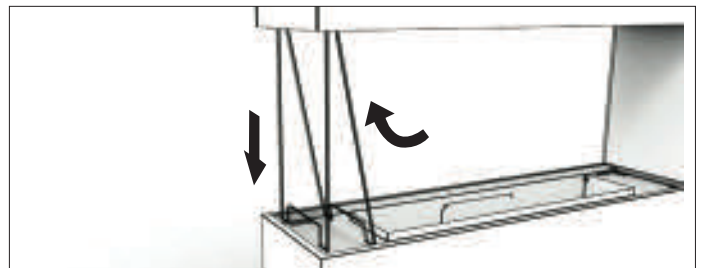

13. 对准预留的两端玻璃孔洞安装挡风玻璃。请使用适当的力度将挡风玻璃推入玻璃夹处固定。

注意：挡风玻璃为钢化玻璃，比常规玻璃在耐温与结构上要强硬。但是钢化玻璃也有脆弱的位置，特别在角落与边缘处如果不小心照料，在特定压力下受损或受压会导致玻璃破裂。我们推荐您在安装时请配套手套以防止玻璃破裂时细小的碎片刮伤。

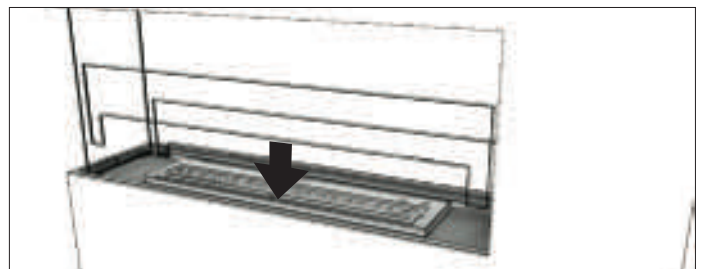

14. 均匀摊开摆放玻璃石进壁炉内。注意：确保燃烧器的炉盖是关闭的。请避免摆放在燃烧器靠近炉芯口的地方以防掉入。摆放时请注意不要刮伤燃烧器表面。

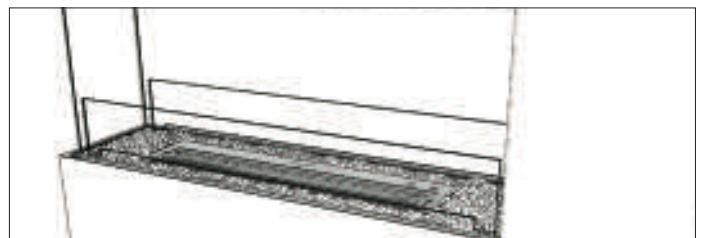

Island

悬浮式壁炉安装

75

准备工具：电钻，螺丝刀，石膏瓦刀，硅胶，填缝枪。

1. 根据表格F所示的开口尺寸搭建框架。底座可以为实心平整的平台以方便校正壁炉的水平线。

注意：不得将本产品插入墙体结构中，必须将其安装在一个单独的框架上，且框架要安全固定到地板上。也不要将本产品安装在可移动或不稳定结构上。产品顶部应安装在固定在天花板上的框架上，并与底部框架对齐。四边式产品是作为隔墙嵌入物设计的。如果不谨慎参考安装指示，墙体或因过热而着火。

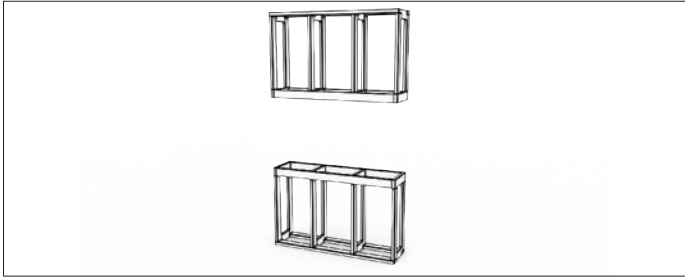

表格F：框架开口尺寸。

请实际测量壁炉规格先以确保制作框架前考量足够公差。

壁炉	宽 mm [in]	深 mm [in]	高 mm [in]	重量* kg [lbs]
FLEX18IL	455 [17.9]	349 [13.6]	730 [28.7]	22.2 [48.9]
FLEX32IL	887 [34.9]	349 [13.6]	730 [28.7]	33.5 [73.7]
FLEX42IL	1142 [45]	349 [13.6]	730 [28.7]	49.8 [109.6]
FLEX50IL	1347 [53]	349 [13.6]	730 [28.7]	59.9 [131.8]
FLEX50IL.BX	1347 [53]	349 [13.6]	730 [28.7]	48.3 [106.3]
FLEX60IL.BX	1602 [63.1]	349 [13.6]	730 [28.7]	64.6 [142.2]
FLEX68IL	1807 [71.1]	349 [13.6]	730 [28.7]	75.2 [165.5]
FLEX68IL.BX	1807 [71.1]	349 [13.6]	730 [28.7]	74.7 [164.4]
FLEX68IL.BX2	1807 [71.1]	349 [13.6]	730 [28.7]	63.1 [138.9]
FLEX78IL.BX2	2062 [81.2]	349 [13.6]	730 [28.7]	79.4 [174.8]
FLEX86IL	2267 [89.3]	349 [13.6]	730 [28.7]	101.5 [223.2]
FLEX86IL.BX	2267 [89.3]	349 [13.6]	730 [28.7]	90 [198.1]
FLEX86IL.BX2	2267 [89.3]	349 [13.6]	730 [28.7]	89.5 [197]
FLEX104IL	2727 [107.4]	349 [13.6]	730 [28.7]	116.3 [255.9]
FLEX104IL.BX	2727 [107.4]	349 [13.6]	730 [28.7]	116.3 [255.9]
FLEX104IL.BX2	2727 [107.4]	349 [13.6]	730 [28.7]	104.8 [230.6]
FLEX122IL	3187 [125.5]	349 [13.6]	730 [28.7]	148.6 [327]
FLEX122IL.BX	3187 [125.5]	349 [13.6]	730 [28.7]	131.1 [288.4]
FLEX122IL.BX2	3187 [125.5]	349 [13.6]	730 [28.7]	131.1 [288.4]
FLEX140IL.BX	3647 [143.6]	349 [13.6]	730 [28.7]	163.4 [359.6]
FLEX140IL.BX2	3647 [143.6]	349 [13.6]	730 [28.7]	145.9 [321.1]
FLEX158IL	4107 [161.7]	349 [13.6]	730 [28.7]	173.9 [382.6]
FLEX158IL.BX2	4107 [161.7]	349 [13.6]	730 [28.7]	178.3 [392.2]

* 壁炉重量包含壁炉（无酒精状态），玻璃石。不包含装饰盒内的玻璃石。

注意：在壁炉上方的框架必须能承载自重与保持结构稳定。因为壁炉本身非结构支撑设计不能承载除了燃烧器等附带配件以外的重量。

2. 移除背面的延长板背板与侧板持平以方便将壁炉滑进框架内。请保管卸下后的螺丝。

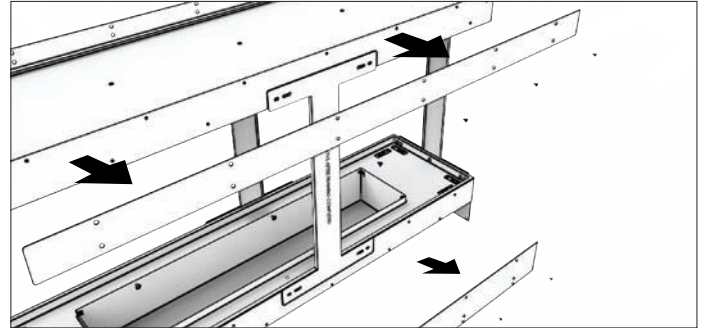

3. 将壁炉滑进框架的腔体内（托盘的底部可以直接架在框架上安装）。壁炉内以预先安装了红色支撑支架在壁炉的开口处以保护在运输与安装过程中不会变形。请将保留红色支撑支架直到框架安装结束为止。

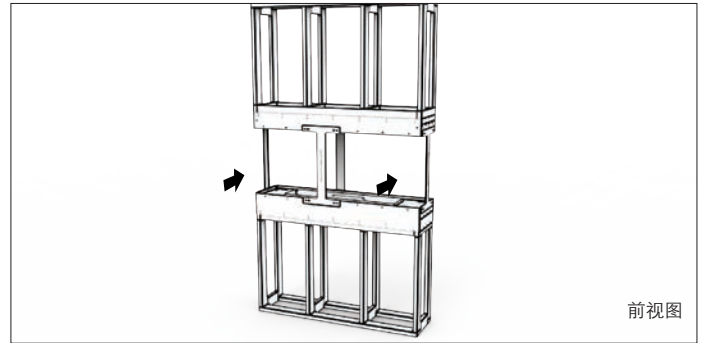

前视图

4. 对齐延长板的孔位，使用附带的螺丝安装至壁炉上并与框架固定牢固。

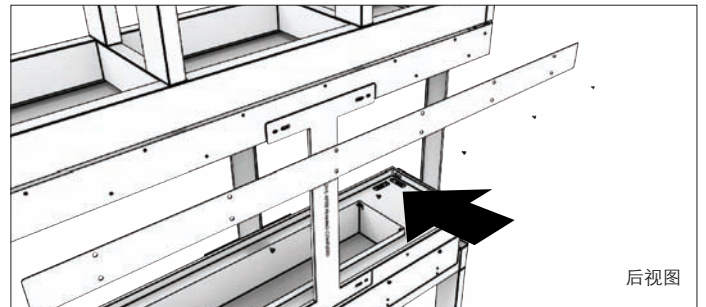

后视图

5. 请用螺丝透过壁炉预留的组装口固定壁炉至框架上。锁紧前请确保壁炉处于水平状态。

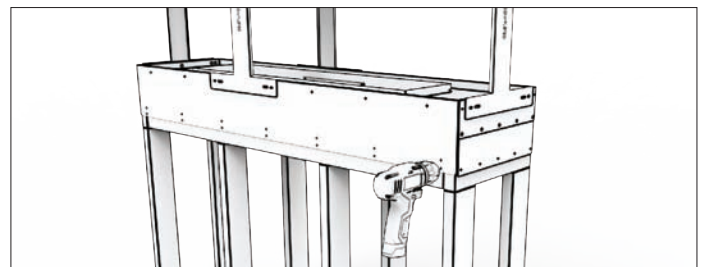

Island

悬浮式壁炉安装

6. 移除红色支撑支架。

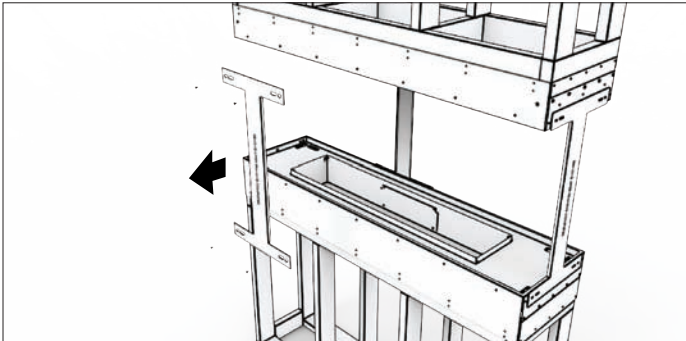

7. 请使用防火墙板包裹住壁炉墙体内的表面。（请参照表面完工指示确保完全理解及使用非可燃性材质安装。）

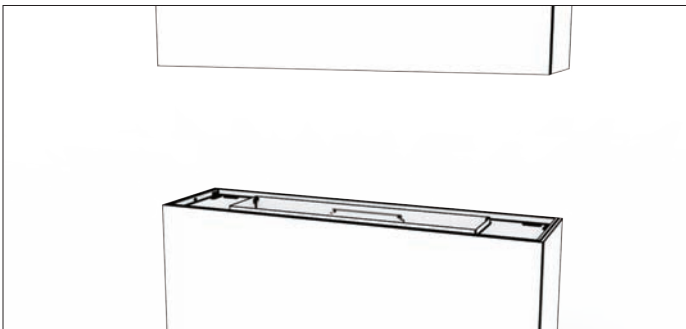

8. 将燃烧器放入壁炉内。

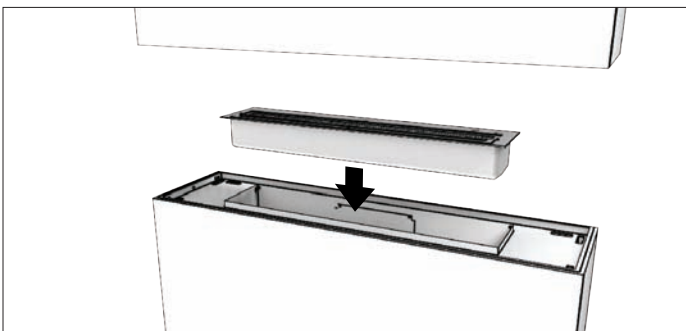

9. 移除玻璃安装孔的防尘贴纸。

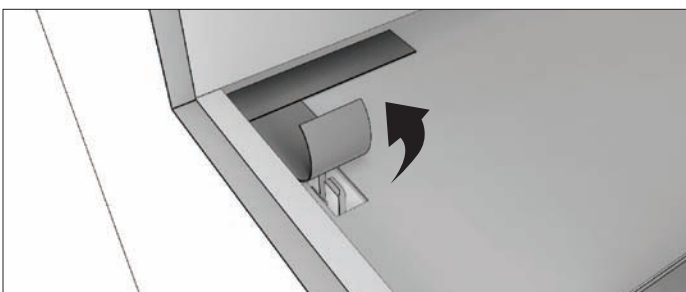

10. 对准预留的两端玻璃孔洞安装挡风玻璃。请使用适当的力度将挡风玻璃推入玻璃夹处固定。对后侧风挡重复同样的操作，如果你的设备在左/右单边或两边都有装饰盒，也可以重复同样的操作。

*装饰铁管请勿直接放置在火焰燃烧的位置。装饰铁盒仅用于美观用途。这种型号产品只需添加一套装饰木。

注意：挡风玻璃为钢化玻璃，比常规玻璃在耐温与结构上要强硬。但是钢化玻璃也有脆弱的位置，特别在角落与边缘处如果不小心照料，在特定压力下受损或受压会导致玻璃破裂。我们推荐您在安装时请配套手套以防止玻璃破裂时细小的碎片刮伤。

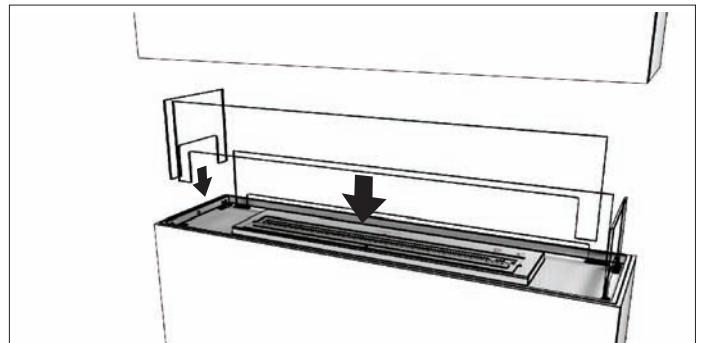

11. 均匀摊开摆放玻璃石进壁炉内。注意：确保燃烧器的炉盖是关闭的。请避免摆放在燃烧器靠近炉芯口的地方以预防掉入。摆放时请注意不要刮伤燃烧器表面。

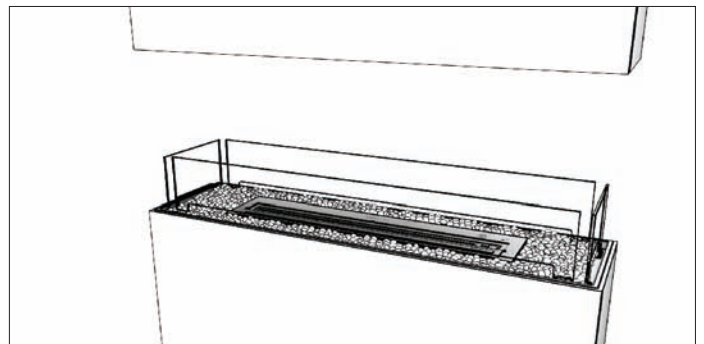

Bench

中岛型壁炉安装

准备工具：电钻，螺丝刀，石膏瓦刀，硅胶，填缝枪。

1. 根据表格G的尺寸数据搭建主框架。底座可以为实心平整的平台以方便校正壁炉的水平线。开始安装之前，请确保燃烧器开口与天花板之间至少有1500mm(59.1")的顶部间隙。

注意：不得将本产品插入墙体结构中，必须将其安装在一个单独的框架上，且框架要安全固定到地板上。产品顶部应安装在固定在天花板上的框架上，并与底部框架对齐。四边式产品是作为隔墙嵌入物设计的。

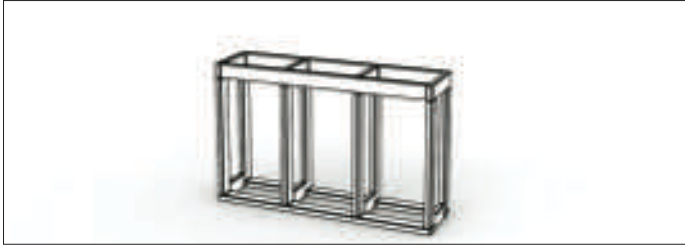

表格G：框架尺寸

请实际测量壁炉规格先以确保制作框架前考量足够公差。

壁炉	宽 mm [in]	深 mm [in]	重量* kg [lbs]
FLEX18BN	455 [17.9]	349 [13.6]	18.3 [40.2]
FLEX32BN	887 [34.9]	349 [13.6]	27.5 [60.6]
FLEX42BN	1142 [45]	349 [13.6]	33.8 [74.4]
FLEX50BN	1347 [53]	349 [13.6]	39.5 [86.9]
FLEX50BN.BX	1347 [53]	349 [13.6]	38.4 [84.5]
FLEX60BN.BX	1602 [63.1]	349 [13.6]	44.7 [98.4]
FLEX68BN	1807 [71.1]	349 [13.6]	50.3 [110.6]
FLEX68BN.BX	1807 [71.1]	349 [13.6]	61.1 [134.5]
FLEX68BN.BX2	1807 [71.1]	349 [13.6]	49.3 [108.5]
FLEX78BN.BX2	2062 [81.2]	349 [13.6]	55.6 [122.4]
FLEX86BN	2267 [89.3]	349 [13.6]	71.6 [157.5]
FLEX86BN.BX	2267 [89.3]	349 [13.6]	61.1 [134.5]
FLEX86BN.BX2	2267 [89.3]	349 [13.6]	61.3 [134.8]
FLEX104BN	2727 [107.4]	349 [13.6]	80 [176]
FLEX104BN.BX	2727 [107.4]	349 [13.6]	82.5 [181.5]
FLEX104BN.BX2	2727 [107.4]	349 [13.6]	72 [158.5]
FLEX122BN	3187 [125.5]	349 [13.6]	105.6 [232.4]
FLEX122BN.BX	3187 [125.5]	349 [13.6]	90.9 [200]
FLEX122BN.BX2	3187 [125.5]	349 [13.6]	93.4 [205.5]
FLEX140BN.BX	3647 [143.6]	349 [13.6]	116.5 [256.3]
FLEX140BN.BX2	3647 [143.6]	349 [13.6]	101.8 [224]
FLEX158BN	4107 [161.7]	349 [13.6]	118.8 [261.4]
FLEX158BN.BX2	4107 [161.7]	349 [13.6]	127.4 [280.3]

* 壁炉重量包含壁炉（无酒精状态），玻璃石。不包含装饰盒内的玻璃石。

2. 移除背面的延长板背板与侧板持平以方便将壁炉滑进框架内。请保管卸下后的螺丝。

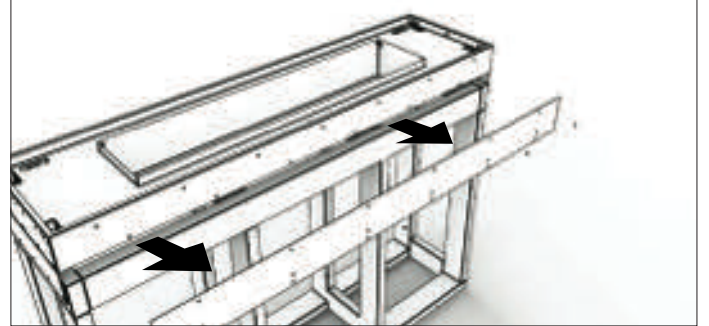

3. 将壁炉滑进框架的腔体内（托盘的底部可以直接架在框架上安装）。

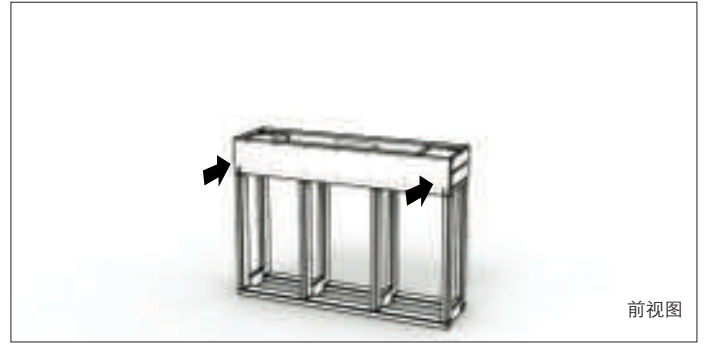

4. 对齐延长板的孔位，使用自带的螺丝安装至壁炉上并与框架固定牢固。

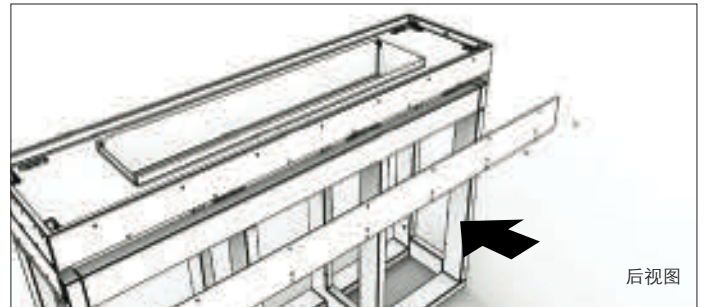

5. 请用螺丝透过壁炉预留的组装口固定壁炉至框架上。锁紧前请确保壁炉处于水平状态。



Bench

中岛型壁炉安装

6. 请使用防火墙板包裹住壁炉墙体内的表面。（请参照表面完工指示确保完全理解与使用非可燃性材质安装。）



7. 将燃烧器放入壁炉内。

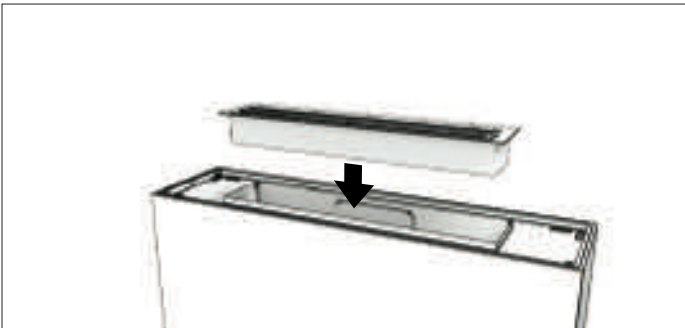

8. 移除玻璃安装孔的防尘贴纸。

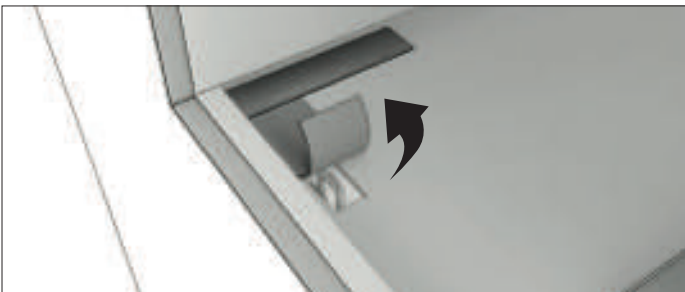

9. 对准预留的两端玻璃孔洞安装挡风玻璃。请使用适当的力度将挡风玻璃推入玻璃夹处固定。对后侧风挡重复同样的操作，如果你的设备在左/右单边或两边都有装饰盒，也可以重复同样的操作。

*装饰铁管请勿直接放置在火焰燃烧的位置。装饰铁盒仅用于美观用途。这种型号产品只需添加一套装饰木。

注意：挡风玻璃为钢化玻璃，比常规玻璃在耐温与结构上要强硬。但是钢化玻璃也有脆弱的位置，特别在角落与边缘处如果不小心照料，在特定压力下受损或受压会导致玻璃破裂。我们推荐您在安装时请配套手套以防止玻璃破裂时细小的碎片刮伤。

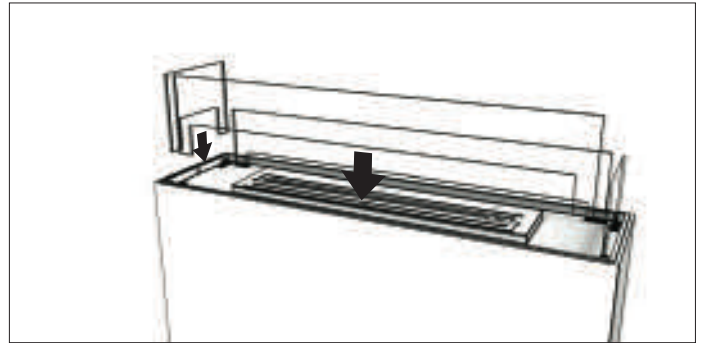

10. 均匀摊开摆放玻璃石进壁炉内。注意：确保燃烧器的炉盖是关闭的。请避免摆放在燃烧器靠近炉芯口的地方以预防掉入。摆放时请注意不要刮伤燃烧器表面。

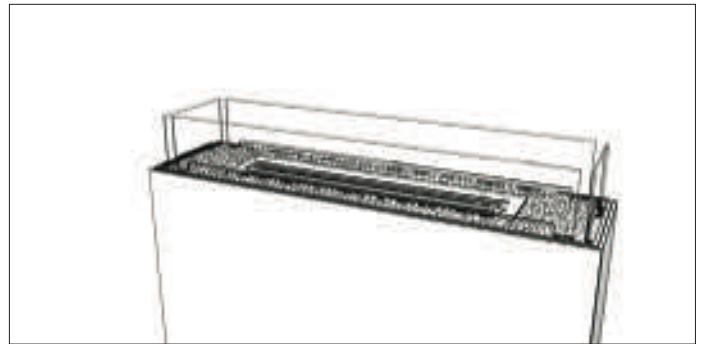

1. 墙体安装前，可采用的材料包括纤维水泥板、耐火中密度纤维板(FR MDF)、石材、瓷砖、钢材和耐火石膏板。

外墙必须不能悬挂于壁炉开口处遮挡。

注意！火灾隐患！请勿在安全间距内放置任何可燃物质。请仔细阅读说明书内列举的可燃物质类别确保安装符合安全要求。

须知：155mm[6'']非可燃板材必须在壁炉开口处的上方安装。
请参照以下示意图：

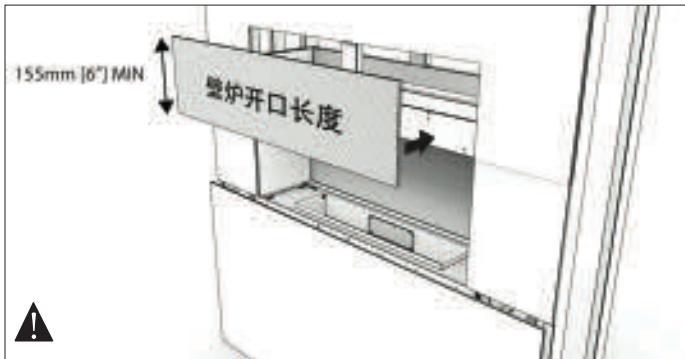

示意图：单面设计壁炉

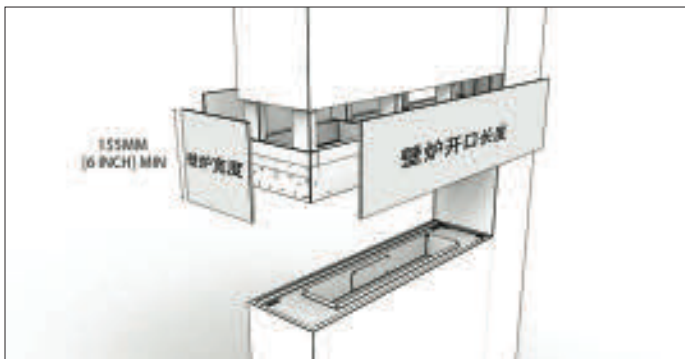

示意图：半开设计壁炉

2. 金属包角必须在各个边角上安装（边缘斜接）。（请勿使用比板材厚度还长的螺丝固定以防止戳穿壁炉本身）。

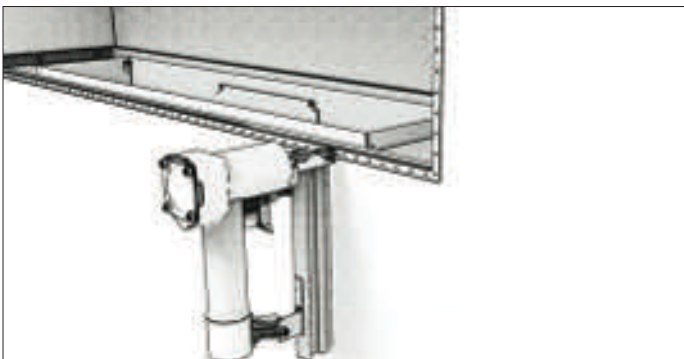

3. 所有金属包角需用石膏填补装饰。

所有拼接处与壁炉正前方均需要使用非可燃性材质填补缝隙。所有用于填补墙壁与壁炉之间的密封胶，例如填缝胶或是乳胶，最低持续性耐温评级必须在150°C (122°F)以上。

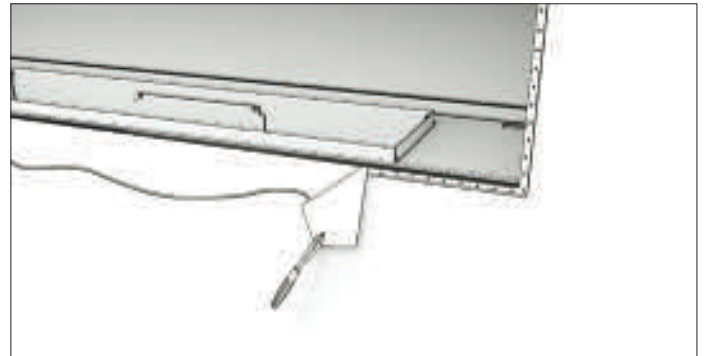

4. 如果墙壁设计里需要上漆，请确保使用100% 丙烯酸乳胶或油性漆或常规亚克力漆。请参照油漆厂商指示说明使用上漆。

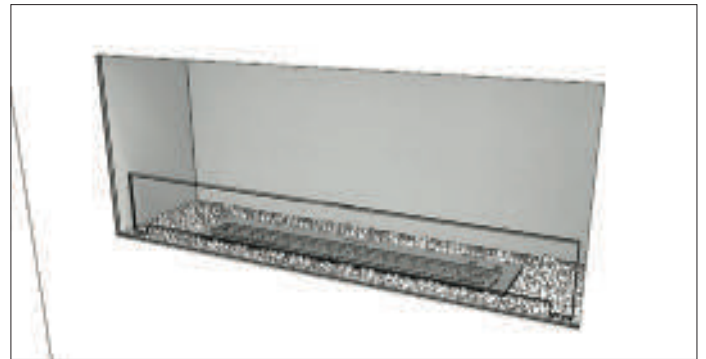

请根据燃烧器内附带说明书正确使用产品。

最小间隙

如果设置里包含了壁炉架请确保参照以下示意图设计最小竖向间距以及最大横向间距。

可燃外墙预留间隙

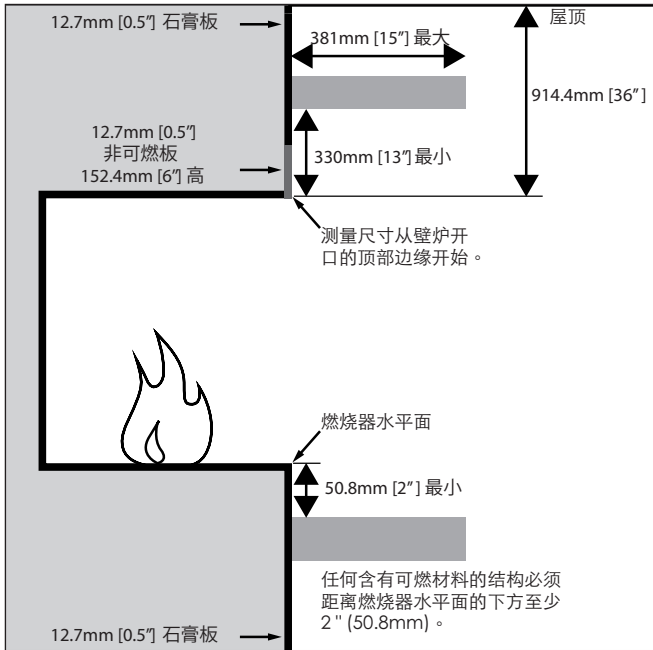

最小竖向与最大横向尺寸可燃框架。

非可燃外墙预留间隙

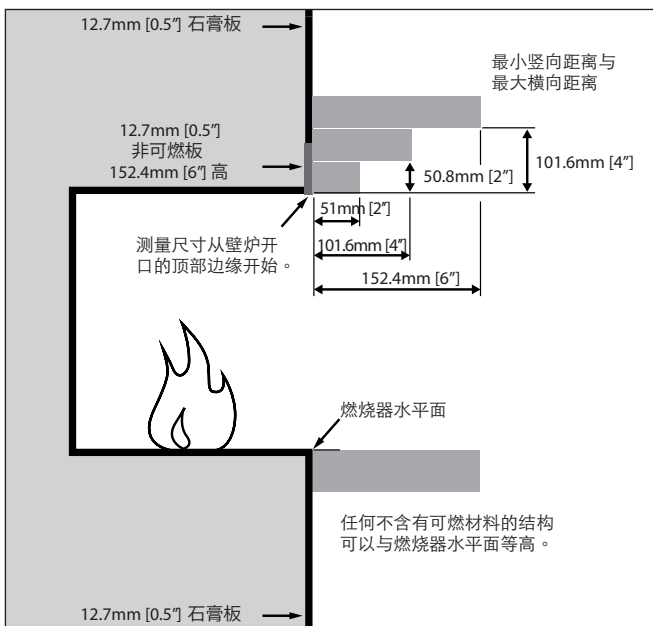

非可燃框架的最小竖向与横向尺寸

注意！火灾隐患！确保按照以上要求预留足够间隙。如果外墙材质接近最小要求尺寸必须完全使用非可燃材质。

壁炉内带侧边装饰盒会附带一片内板用于摆放装饰物件。装饰盒必须只可搭配非可燃材质的配件/物件。

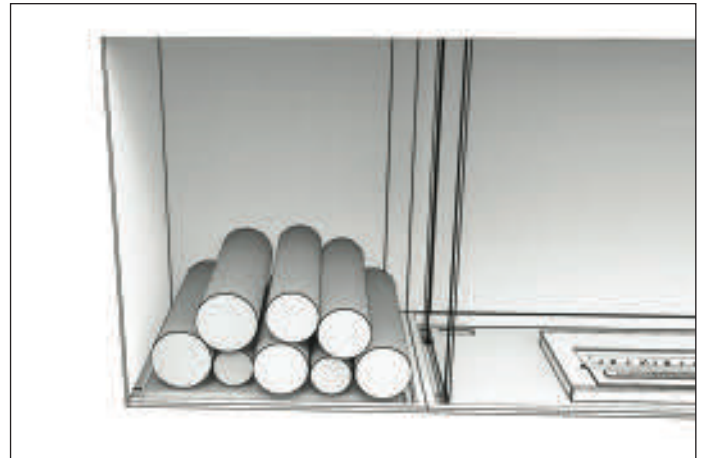
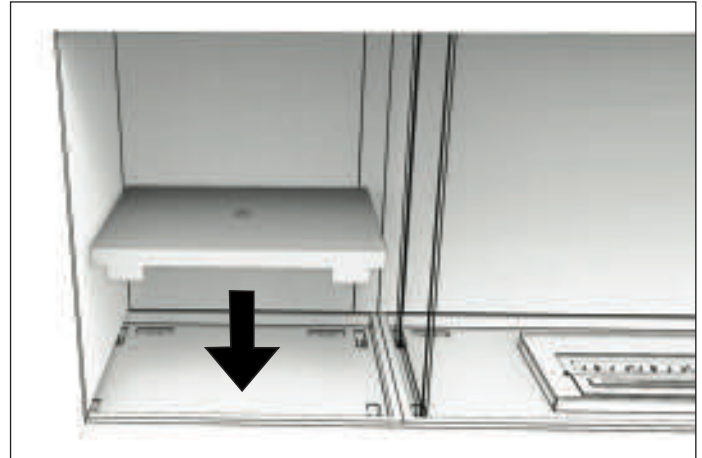

装饰铁条为可选配件。更多详细信息请联系 customerservice@ecosmartfire.com

*装饰铁管请勿直接放置在火焰燃烧的位置。装饰铁盒仅用于美观用途。

Sicurezza degli apparecchi

SELEZIONARE LA POSIZIONE DELL'APPARECCHIO	82
VENTILAZIONE	82
DIMENSIONE MINIMA DELLA STANZA	82

Installazione dell'apparecchio

INQUADRATURA	83
PRIMA DI INIZIARE	84
INSTALLAZIONE LATO SINGOLO	85 - 86
INSTALLAZIONE ANGOLO SINISTRO	87 - 88
INSTALLAZIONE ANGOLO DESTRO	87 - 88
INSTALLAZIONE BAY	89 - 90
INSTALLAZIONE A DUE LATI	91 - 92
INSTALLAZIONE PENISOLA	93 - 94
INSTALLAZIONE ISOLA	95 - 96
INSTALLAZIONE A BANCO	97 - 98
FINITURA	99
BORDO DEL CAMINO	100
PIATTAFORMA PER BOX DECORATIVA	100

Questi apparecchi sono approvati dal produttore solo per l'uso con i bruciatori elencati UL.

FUNZIONAMENTO

Fare riferimento al Manuale delle operazioni incluso con il bruciatore.

Sicurezza degli apparecchi

Leggere attentamente queste istruzioni prima di installare e utilizzare EcoSmart™ Fire.

SELEZIONARE LA POSIZIONE DELL'APPARECCHIO

Lo spazio zero è stato progettato per l'apparecchio e ha le autorizzazioni necessarie per componenti del telaio combustibili già integrati. Sono progettati specificamente per accettare EcoSmart Fire bruciatori compatibili.

Quando si seleziona un luogo per l'apparecchio, è importante considerare le dimensioni minime delle stanze e gli spazi liberi necessari per le pareti e i materiali combustibili (vedere le immagini delle distanze inferiori e la tabella delle dimensioni minime del locale).

Nota: gli apparecchi Flex sono realizzati in acciaio zincato e verniciato a polvere con vernice nera super resistente che impedisce la formazione di ruggine. I bruciatori sono realizzati in acciaio inox 304. Per garantire che il / i bruciatore / i continui ad avere un aspetto gradevole ed evitare la ruggine o la corrosione, è importante che qualsiasi contaminazione o detrito venga pulito o rimosso dal bruciatore immediatamente.

Se installato all'aperto, l'apparecchio deve essere posizionato sotto una sporgenza protettiva per evitare che si riempia di acqua e venga danneggiato permanentemente. La garanzia è nulla se il prodotto è danneggiato a causa dell'installazione in un luogo esposto.

Quando non è in uso, mantenere il coperchio del bruciatore chiuso per salvaguardare il bruciatore dai detriti che cadono nella camera del bruciatore e causare contaminazione.

AVVERTENZA: rischio di incendio o ustioni! Fornire uno spazio adeguato intorno alle aperture dell'aria e per l'accesso al servizio. Rispettare gli spazi liberi per i combustibili consigliati in questo manuale e il manuale del bruciatore. Assicurarsi che il fuoco sia posizionato lontano da materiali infiammabili e altre fonti di ignizione in ogni momento. A causa delle alte temperature, l'apparecchio deve essere collocato lontano dal traffico e lontano da mobili e tendaggi. Prestare molta attenzione a posizionare il fuoco lontano da oggetti che possono muoversi a causa di vento e correnti d'aria. Per esempio alberi / rami / tende / carta e simili. Tenere i bambini a una distanza di sicurezza in ogni momento e non lasciarli mai incustoditi quando l'apparecchio è acceso o caldo.

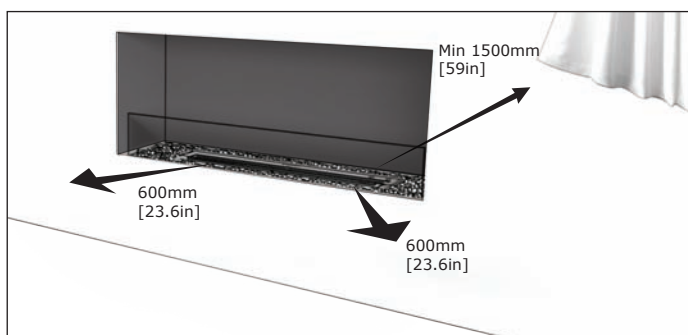

Sicurezza per interni

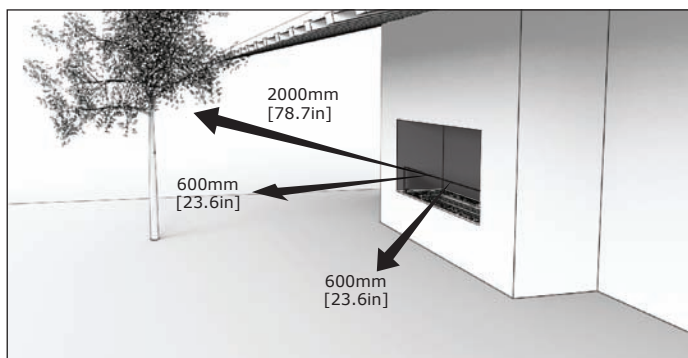

Distanze per esterni (necessità di sporgenza o "estensione del tetto" sopra il caminetto per garantire che la pioggia non entri nel focolare. Controllare con i codici di costruzione locali per quanto riguarda i requisiti per sporgenze / estensioni del tetto.)

VENTILAZIONE

Gli EcoSmart Fires non richiedono alcun tipo di dispositivo o raccordo permanente, come una canna fumaria per la ventilazione, una connessione permanente o qualsiasi tipo di utilità fissa per l'alimentazione di carburante.

Non coprire i sistemi di ventilazione esistenti o le strutture che sono state costruite o installate all'interno dell'area di installazione scelta.

Per garantire un'adeguata ventilazione, assicurarsi di seguire le linee guida indicate nella tabella.

Underwriters Laboratories (UL) calcola un adeguato ricambio d'aria come segue:

In una casa di costruzione tipica, vale a dire, che non è di costruzione insolitamente rigida a causa di un forte isolamento e di tenute strette contro le infiltrazioni d'aria, attraverso l'infiltrazione viene fornita un'adeguata riserva d'aria per la combustione e la ventilazione. Tuttavia, se il bruciatore viene utilizzato in una piccola stanza in cui sono previsti meno di 5,7 m³ [200 ft³] di spazio d'aria per ogni 1000 BTU all'ora di potenza nominale dell'apparecchio (considerando l'impostazione massima del bruciatore), le porte della stanza adiacente (s) deve essere tenuto aperto o una finestra verso l'esterno deve essere aperta di almeno 25,4 mm [1in] per proteggersi dal potenziale accumulo di inquinamento dell'aria interna. Non installare o utilizzare in un bagno o in qualsiasi altra piccola stanza.

DIMENSIONE MINIMA DELLA STANZA

Tabella di ventilazione basata sul numero di bruciatori (per apparecchio).

Apparecchio	Bruciatore	Dimensione minima della stanza	BTU
FLEX18	1x AB3	1413 cubica (40 cu. Metri)	5,800
FLEX32 FLEX50.BX FLEX68.BX2	1x XL500	2825 cubica (80 cu. Metri)	11,430
FLEX42 FLEX60.BX FLEX78.BX2	1x XL700	3178 cubica (90 cu. Metri)	13,650
FLEX50 FLEX68.BX FLEX86.BX2	1x XL900	3884 cubica (110 cu. Metri)	15,000
FLEX68 FLEX86.BX FLEX104.BX2	1x XL1200	4061 cubica (115 cu. Metri)	16,200
FLEX86 FLEX104.BX FLEX122.BX2	2x XL900	7768 cubica (220 cu. Metri)	30,000
FLEX104 FLEX122.BX FLEX140.BX2	2x XL1200	8122 cubica (230 cu. Metri)	32,400
FLEX122 FLEX140.BX FLEX158.BX2	3x XL900	11652 cubica (330.2 cu. Metri)	45,000
FLEX158	3x XL1200	12183 cubica (345 cu. Metri)	48,600

NON DESTINATO ALL'USO COME SORGENTE DI CALORE PRIMARIA. Questo apparecchio è testato e approvato come riscaldamento supplementare per ambienti o come dispositivo decorativo. Non deve essere considerato come calore primario nei calcoli del riscaldamento residenziale.

Installazione dell'apparecchio

Questi apparecchi devono essere installati in una posizione di sicurezza fissa prima di essere utilizzati.

AVVISO: NON INSTALLARE DIRETTAMENTE ALL'ESTERNO O VICINO A WALLPAPER, LAMINATO, IMPIALLACCIATO O QUALSIASI SUPERFICIE CHE NON È PROGETTATA PER SOPPRESSIONE DI CALORE E DI ALTA TEMPERATURA (il calore influirà sul materiale e, in alcune circostanze, sulla colla utilizzata per la sua applicazione). L'AREA INTORNO ALL'APPARECCHIO RICEVE CALDA. NON DEVONO ESSERE UTILIZZATI MATERIALI RICONTRI SENSIBILI / REATTIVI. NON POSIZIONARE OGGETTI INFIAMMABILI O CIRCONDI ALL'APPARECCHIO.

Questi apparecchi non sono progettati per incorporare porte o coperture di apertura.

L'apparecchio deve rimanere sempre aperto per la ventilazione - non è progettato per funzionare come un forno o simili "scatole calde" - la fiamma deve avere un flusso d'aria costante per funzionare ed essere in grado di far circolare e distribuire il calore in modo efficace

NON CONFEZIONARE GLI SPAZI D'ARIA RICHIESTI (lo spazio tra l'apparecchio e il distanziale) **CON ISOLAMENTO O ALTRI MATERIALI**. I DISTANZIATORI DELL'ARIA SONO NECESSARI PER ASSICURARE ADEGUATE TEMPERATURE DIETRO L'APPARECCHIO.

Non modificare l'apparecchio in alcun modo durante l'installazione. È vietato tagliare parti in lamiera dell'apparecchio.

L'espansione e la contrazione delle parti interne a causa del riscaldamento e del raffreddamento potrebbero creare rumore. È normale.

AVVERTENZA: NON UTILIZZARE SENZA IL WINDSCREEN DI VETRO

L'apparecchio deve essere completamente montato prima di essere utilizzato. La mancata installazione (o rimozione) dei pannelli in vetro renderà nulla la garanzia e renderà il prodotto non approvato per l'uso con il bruciatore incluso.

INQUADRATURA

Considerazioni importanti per l'inquadratura

1. L'apparecchio deve essere installato su una superficie piana in grado di sostenere l'apparecchio, il bruciatore, il carbone di vetro e la piena capacità di carburante.
2. Le dimensioni dell'inquadratura mostrate nelle istruzioni sono le dimensioni ottimali che consentono di adattarsi al meglio con gyprock / cartongesso / cartongesso (o altro materiale di rivestimento / finitura) dopo che l'apparecchio è stato installato.
3. Preparare il percorso di installazione. Se si posiziona l'apparecchio su una piattaforma, costruire la piattaforma, assicurandosi di adattare il peso dell'apparecchio, del bruciatore, del carbone di vetro e del carburante. Verifica che la piattaforma sia a livello.

In caso di capacità insufficiente per sostenere il peso dell'apparecchio, è necessario prendere le misure necessarie per rinforzare l'impostazione (ad esempio l'installazione di una piastra per la distribuzione del carico) in modo che l'impostazione sia adatta per l'installazione.

IMPORTANTE: la cornice sopra l'apparecchio deve essere autoportante. L'apparecchio non è portante.

DEFINIZIONI

Materiali combustibili - I materiali costituiti o rivestiti con legno, carta compressa, fibre vegetali, plastica o altro materiale che può infiammarsi e bruciare, sia che la fiamma sia prodotta o meno, o intonacato o non intonacato devono essere considerati materiali combustibili.

Materiali non combustibili - materiali che non si accendono e bruciano. Tali materiali sono quelli costituiti interamente da acciaio, ferro, mattoni, mattonelle, cemento, ardesia, vetro o intonaco o qualsiasi combinazione di questi. HardieBacker®, WonderBoard®, Durock® o materiali segnalati come ASTM E 136 di passaggio, metodo di prova standard per il comportamento dei materiali in un forno tubolare verticale a 750 ° C devono essere considerati materiali non combustibili.

NOTA: le illustrazioni riflettono le installazioni tipiche e sono SOLO PER SCOPI DI PROGETTAZIONE. Le illustrazioni / i diagrammi non sono disegnati in scala. L'installazione effettiva può variare a seconda delle preferenze di progettazione individuali.

Installazione dell'apparecchio

PRIMA DI INIZIARE

1. Rimuovere con attenzione l'apparecchio e i componenti dalla confezione
2. Ispezionare e segnalare eventuali parti danneggiate durante la spedizione, in particolare le condizioni del parabrezza in vetro.
3. Leggere tutte le istruzioni prima di iniziare l'installazione. Seguire attentamente queste istruzioni durante l'installazione per garantire la massima sicurezza e benefici.

AVVERTENZA: rischio di incendio o esplosione! Le parti danneggiate possono compromettere il funzionamento sicuro. Non installare componenti danneggiati, incompleti o sostitutivi.

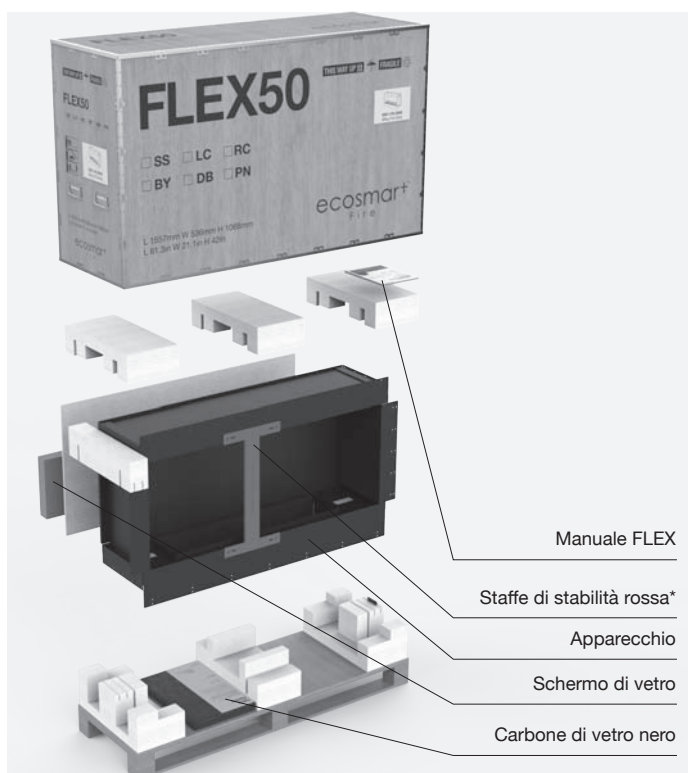

Cassa dell'apparecchio

* Non applicabile ai modelli Flex Bench.

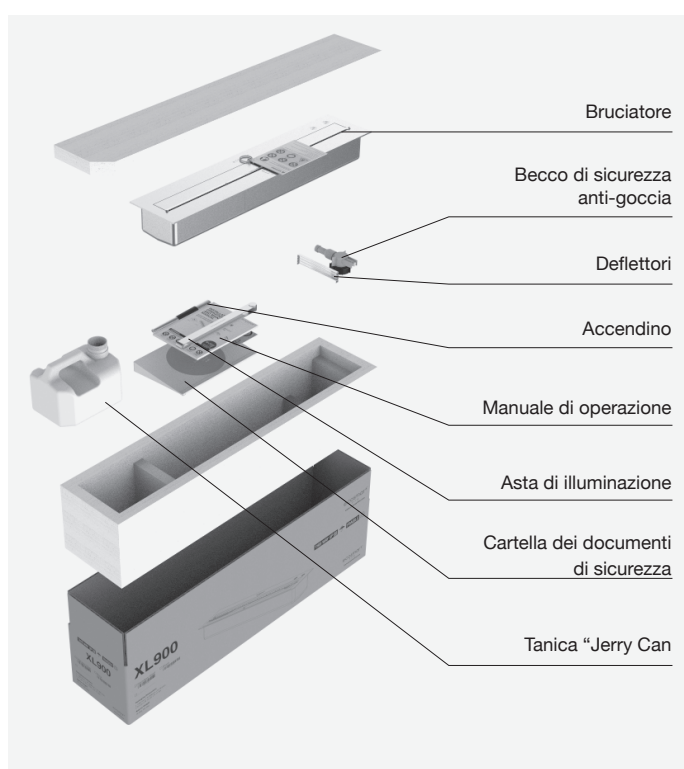

Scatola del bruciatore

Installazione Lato Singolo

Attrezzatura necessaria: trapano elettrico, cacciavite, livella, cazzuola, pistola siliconica, pistola per calafataggio

1. Costruire la struttura della parete principale con le dimensioni di apertura mostrate nella Tabella A. La base del telaio può essere una panca / piattaforma solida, che aiuterà a livellare l'apparecchio quando è in posizione.



Tabella A: Dimensioni iniziali di apertura

Le dimensioni dell'apparecchio devono essere verificate rispetto alle dimensioni tagliate PRIMA che l'installazione abbia inizio per confermare le tolleranze allineate.

APPARECCHIO	L mm [in]	P mm [in]	A mm [in]	Peso* kg [lbs]
FLEX18SS	488 [19.2]	365 [14.4]	730 [28.7]	25.7 [56.5]
FLEX32SS	922 [36.3]	365 [14.4]	730 [28.7]	45.7 [100.5]
FLEX42SS	1177 [46.3]	365 [14.4]	730 [28.7]	60 [131.9]
FLEX50SS	1380 [54.3]	365 [14.4]	730 [28.7]	71.4 [157.1]
FLEX50SS.BX	1380 [54.3]	365 [14.4]	730 [28.7]	69.9 [153.8]
FLEX60SS.BX	1634 [64.3]	365 [14.4]	730 [28.7]	83.9 [184.6]
FLEX68SS	1840 [72.4]	365 [14.4]	730 [28.7]	97.1 [213.6]
FLEX68SS.BX	1840 [72.4]	365 [14.4]	730 [28.7]	95.1 [209.2]
FLEX68SS.BX2	1840 [72.4]	365 [14.4]	730 [28.7]	93.9 [206.7]
FLEX78SS.BX2	2090 [82.3]	365 [14.4]	730 [28.7]	107.8 [237.1]
FLEX86SS	2300 [90.5]	365 [14.4]	730 [28.7]	121.5 [267.3]
FLEX86SS.BX	2300 [90.5]	365 [14.4]	730 [28.7]	119.4 [262.7]
FLEX86SS.BX2	2300 [90.5]	365 [14.4]	730 [28.7]	118.8 [261.4]
FLEX104SS	2760 [108.7]	365 [14.4]	730 [28.7]	146.2 [321.6]
FLEX104SS.BX	2760 [108.7]	365 [14.4]	730 [28.7]	145.2 [319.4]
FLEX104SS.BX2	2760 [108.7]	365 [14.4]	730 [28.7]	193.8 [426.4]
FLEX122SS	3220 [126.7]	365 [14.4]	730 [28.7]	171.5 [377.3]
FLEX122SS.BX	3220 [126.7]	365 [14.4]	730 [28.7]	170.1 [374.2]
FLEX122SS.BX2	3220 [126.7]	365 [14.4]	730 [28.7]	168.9 [371.6]
FLEX140SS.BX	3680 [144.9]	365 [14.4]	730 [28.7]	195.2 [429.4]
FLEX140SS.BX2	3680 [144.9]	365 [14.4]	730 [28.7]	193.8 [426.4]
FLEX158SS	4140 [163]	365 [14.4]	730 [28.7]	222.1 [488.6]
FLEX158SS.BX2	4140 [163]	365 [14.4]	730 [28.7]	218.9 [481.6]

* Il peso dell'apparecchio include il / i bruciatore / i (peso a secco escluso il carburante), carbone di legna e vetro. NON include carbone di vetro per scatole laterali.

IMPORTANTE: la cornice sopra l'apparecchio deve essere autoportante. L'apparecchio non è portante.

2. Far scorrere l'apparecchio all'interno della cavità di incorniciatura (la base dell'apparecchio può essere posizionata direttamente sopra il materiale di inquadratura 2 x 4). L'apparecchio viene fornito con staffe di stabilità rosse installate sul / i lato / i aperto / i per mantenere l'apparecchio squadrato durante il trasporto e durante l'installazione. Mantenere la / e staffa / e accesa mentre si incornicia l'impostazione per aiutare a ridurre al minimo il movimento dell'apparecchio.

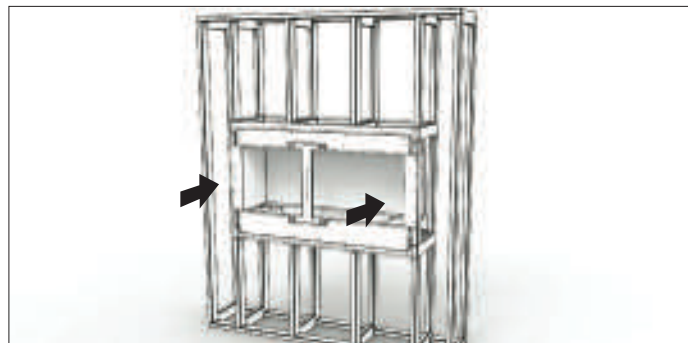

3. Fissare l'apparecchio alla struttura con le viti utilizzando i fori di montaggio esistenti sulle flange dell'apparecchio. Assicurarsi che l'apparecchio sia a livello prima di fissarlo in posizione.



4. Rimuovere le staffe di stabilità rosse.

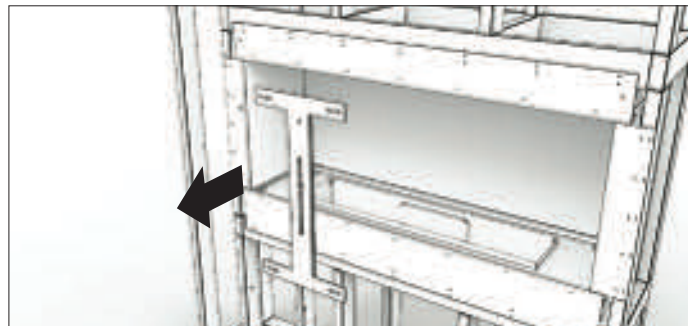

Installazione Lato Singolo

5. Completare la costruzione rifinendo i pannelli a muro attorno all'apparecchio. (Vedere la sezione sulle **ISTRUZIONI PER LA FINITURA** e assicurarsi di comprendere appieno dove devono essere usati materiali non combustibili.)

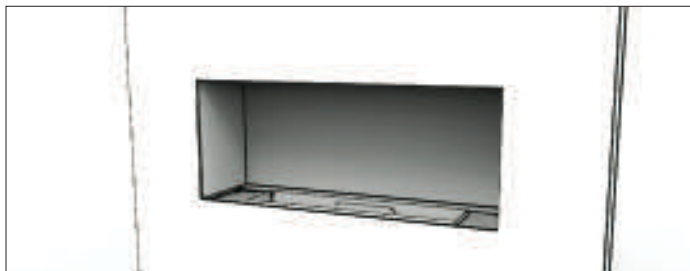

6. Mettere il bruciatore in posizione.



7. Rimuovere il nastro protettivo antipolvere che copre le fessure di montaggio del parabrezza.

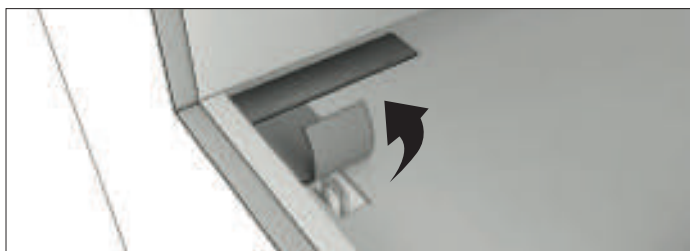

8. Se l'elettrodomestico include un riquadro decorativo a sinistra / a destra o entrambi, inserire il pannello di vetro interno / i alimentando il vetro verso l'alto nello slot, quindi spingendolo verso il basso nelle clip posizionate.

** I ceppi decorativi NON devono essere posti direttamente sopra una fiamma aperta. Sono progettati per sedersi vicino al calore ma non sopra le fiamme.*

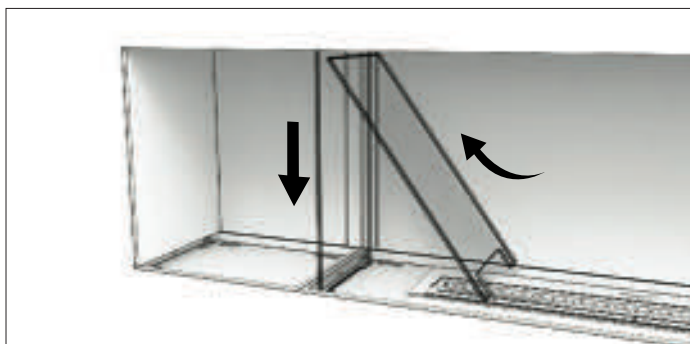

9. Installare il parabrezza inserendo le due estremità nelle apposite fessure nell'apparecchio. Utilizzare una piccola quantità di pressione per spingere il parabrezza in posizione fino a quando raggiunge il fondo nelle clip di vetro nascoste.

AVVERTENZA: il vetro utilizzato è in vetro temperato, il che significa che è più resistente del normale vetro. È importante sottolineare che, anche se è più forte, il vetro temprato ha ancora punti deboli. Gli angoli e i lati sono punti di pressione specifici dove è più fragile e possono rompersi se non si presta attenzione. Il vetro si rompe in molti piccoli pezzi. Fare attenzione per evitare tagli. Si consiglia di indossare guanti protettivi quando si maneggia il vetro.



10. Stendere il carbone di vetro in modo uniforme attorno al vassoio dell'apparecchio. **ATTENZIONE:** assicurarsi che il coperchio del bruciatore sia chiuso. Tenere il carbone di vetro lontano dalla flangia del bruciatore per evitare che il carbone di vetro entri accidentalmente nella camera del bruciatore. Fare attenzione a non graffiare il bruciatore.

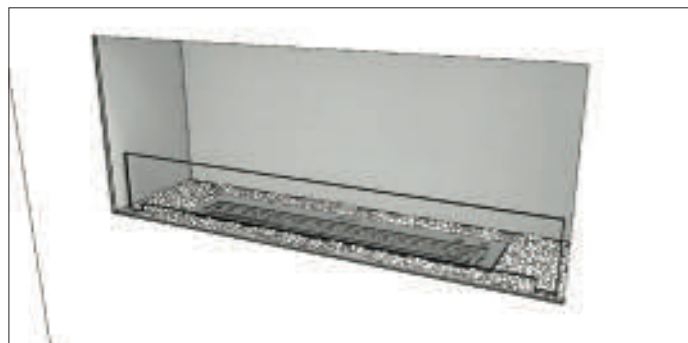

Installazione Angolo Sinistro e Angolo Destro

Attrezzatura necessaria: trapano elettrico, cacciavite, livella, cazzuola, pistola siliconica, pistola per calafataggio

1. Costruire la struttura della parete principale con le dimensioni di apertura mostrate nella Tabella B. La base del telaio può essere una panca / piattaforma solida, che aiuterà a livellare l'apparecchio quando è in posizione.

NOTA: le illustrazioni sono dell'installazione Angolo Sinistro



Tabella B: Dimensioni iniziali di apertura

Le dimensioni dell'apparecchio devono essere verificate rispetto alle dimensioni tagliate PRIMA che l'installazione abbia inizio per confermare le tolleranze allineate.

APPARECCHIO (LC & RC)	L mm [in]	P mm [in]	A mm [in]	Peso* kg [lbs]
FLEX18LC	470 [18.5]	365 [14.4]	730 [28.7]	33 [72.6]
FLEX32LC	902 [35.5]	365 [14.4]	730 [28.7]	48.8 [107.4]
FLEX42LC	1157 [45.5]	365 [14.4]	730 [28.7]	63.3 [139.3]
FLEX50LC	1362 [53.6]	365 [14.4]	730 [28.7]	71.6k [157.5]
FLEX50LC.BX	1362 [53.6]	365 [14.4]	730 [28.7]	73.1 [160.8]
FLEX60LC.BX	1617 [63.7]	365 [14.4]	730 [28.7]	87.1 [191.6]
FLEX68LC	1822 [71.7]	365 [14.4]	730 [28.7]	100.3 [220.7]
FLEX68LC.BX	1822 [71.7]	365 [14.4]	730 [28.7]	95.3 [209.7]
FLEX68LC.BX2	1822 [71.7]	365 [14.4]	730 [28.7]	97kg [213.4]
FLEX78LC.BX2	2077 [81.8]	365 [14.4]	730 [28.7]	111 [244.2]
FLEX86LC	2282 [89.8]	365 [14.4]	730 [28.7]	121.7 [267.7]
FLEX86LC.BX	2282 [89.8]	365 [14.4]	730 [28.7]	122.6 [269.7]
FLEX86LC.BX2	2282 [89.8]	365 [14.4]	730 [28.7]	119 [261.8]
FLEX104LC	2742 [107.9]	365 [14.4]	730 [28.7]	149.5 [328.9]
FLEX104LC.BX	2742 [107.9]	365 [14.4]	730 [28.7]	145.4 [319.9]
FLEX104LC.BX2	2742 [107.9]	365 [14.4]	730 [28.7]	146.9 [323.2]
FLEX122LC	3202 [126.1]	365 [14.4]	730 [28.7]	171.7 [377.7]
FLEX122LC.BX	3202 [126.1]	365 [14.4]	730 [28.7]	173.4 [381.5]
FLEX122LC.BX2	3202 [126.1]	365 [14.4]	730 [28.7]	169.1 [372]
FLEX140LC.BX	3662 [144.2]	365 [14.4]	730 [28.7]	197.1 [433.6]
FLEX140LC.BX2	3662 [144.2]	365 [14.4]	730 [28.7]	195.4 [429.9]
FLEX158LC	4122 [162.3]	365 [14.4]	730 [28.7]	225.5 [496.1]
FLEX158LC.BX2	4122 [162.3]	365 [14.4]	730 [28.7]	219.1 [482]

* Il peso dell'apparecchio include il / i bruciatore / i (peso a secco escluso il carburante), carbone di legna e vetro. NON include carbone di vetro per scatole laterali.

IMPORTANTE: la cornice sopra l'apparecchio deve essere autoportante. L'apparecchio non è portante.

2. Far scorrere l'apparecchio all'interno della cavità di incorniciatura (la base dell'apparecchio può essere posizionata direttamente sopra il materiale di inquadratura 2 x 4). L'apparecchio viene fornito con staffe di stabilità rosse installate sul / i lato / i aperto / i per mantenere l'apparecchio squadrato durante il trasporto e durante l'installazione. Mantenere la / e staffa / e accesa mentre si incornicia l'impostazione per aiutare a ridurre al minimo il movimento dell'apparecchio. Allineare il pannello di estensione della flangia d'angolo superiore con i fori filettati sul ripiano superiore e avvitare in posizione con le viti incluse.

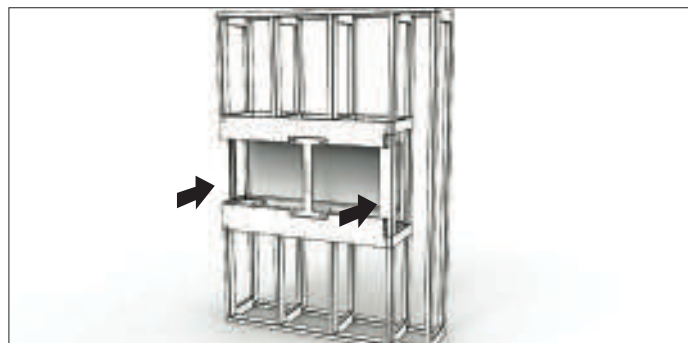

3. Fissare l'apparecchio alla struttura con le viti utilizzando i fori di montaggio esistenti sulle flange dell'apparecchio. Assicurarsi che l'apparecchio sia a livello prima di fissarlo in posizione.



4. Rimuovere le staffe di stabilità rosse.

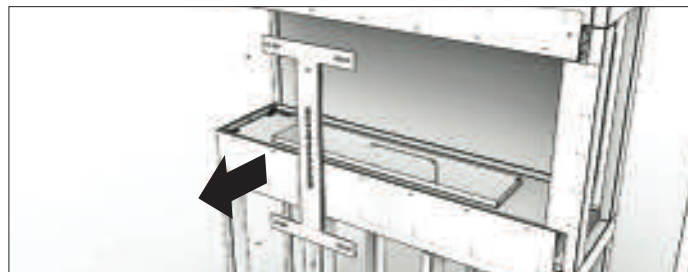

5. Completare la costruzione rifinendo i pannelli a muro attorno all'apparecchio. (Vedere la sezione sulle **ISTRUZIONI PER LA FINITURA** e assicurarsi di comprendere appieno dove devono essere usati materiali non combustibili.)

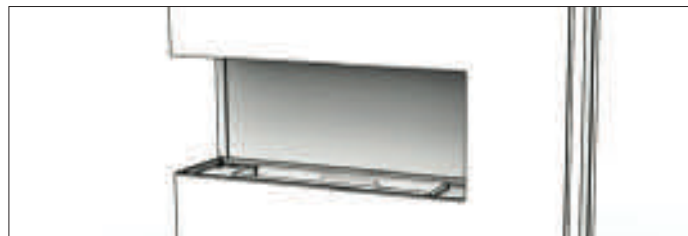

Installazione Angolo Sinistro e Angolo Destro



6. Mettere il bruciatore in posizione.

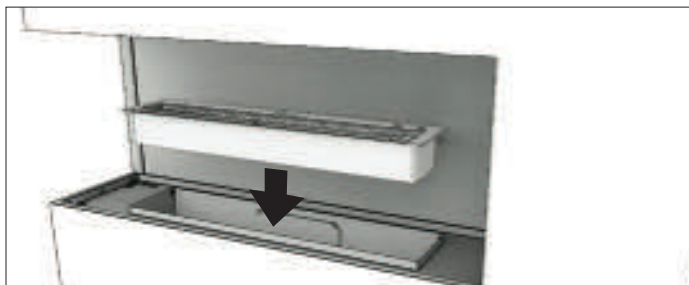

7. Rimuovere il nastro protettivo antipolvere che copre le fessure di montaggio del parabrezza.



8. Se l'elettrodomestico include un riquadro decorativo a sinistra / a destra o entrambi, inserire il pannello di vetro interno / i alimentando il vetro verso l'alto nello slot, quindi spingendolo verso il basso nelle clip posizionate.

** I ceppi decorativi NON devono essere posti direttamente sopra una fiamma aperta. Sono progettati per sedersi vicino al calore ma non sopra le fiamme.*

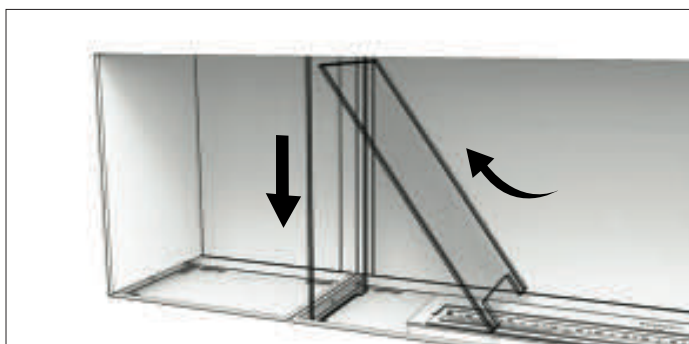

9. Inserire il pannello di vetro a tutta altezza in uno dei lati dell'estremità aperta inserendo il vetro nell'apertura nella parte superiore dell'apparecchio e abbassandolo nelle fessure nella base fino a farlo scendere in posizione..

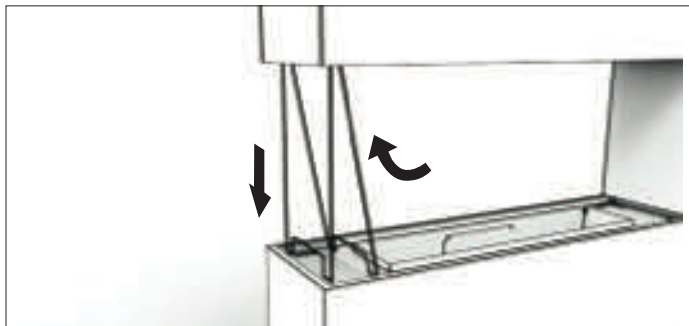

10. Installare il parabrezza inserendo le due estremità nelle apposite fessure nell'apparecchio. Utilizzare una piccola quantità di pressione per spingere il parabrezza in posizione fino a quando raggiunge il fondo nelle clip di vetro nascoste.

AVVERTENZA: il vetro utilizzato è in vetro temperato, il che significa che è più resistente del normale vetro. È importante sottolineare che, anche se è più forte, il vetro temprato ha ancora punti deboli. Gli angoli e i lati sono punti di pressione specifici dove è più fragile e possono rompersi se non si presta attenzione. Il vetro si rompe in molti piccoli pezzi. Fare attenzione per evitare tagli. Si consiglia di indossare guanti protettivi quando si maneggia il vetro.ass.



11. Stendere il carbone di vetro in modo uniforme attorno al vassoio dell'apparecchio. **ATTENZIONE:** assicurarsi che il coperchio del bruciatore sia chiuso. Tenere il carbone di vetro lontano dalla flangia del bruciatore per evitare che il carbone di vetro entri accidentalmente nella camera del bruciatore. Fare attenzione a non graffiare il bruciatore.

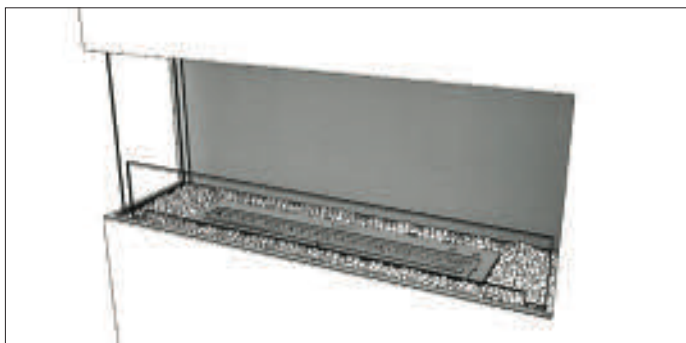

Installazione

Bay

Attrezzatura necessaria: trapano elettrico, cacciavite, livella, cazzuola, pistola siliconica, pistola per calafataggio

1. Costruire la struttura della parete principale con le dimensioni di apertura mostrate nella Tabella C. La base del telaio può essere una panca / piattaforma solida, che aiuterà a livellare l'apparecchio quando è in posizione.



Tabella C: Dimensioni iniziali di apertura

Le dimensioni dell'apparecchio devono essere verificate rispetto alle dimensioni tagliate PRIMA che l'installazione abbia inizio per confermare le tolleranze allineate.

APPARECCHIO	L mm [in.]	P mm [in.]	A mm [in.]	Peso* kg [lbs]
FLEX18BY	460 [18.1]	365 [14.4]	730 [28.7]	40.7 [89.5]
FLEX32BY	892 [35.1]	365 [14.4]	730 [28.7]	51.9 [114.2]
FLEX42BY	1147 [45.2]	365 [14.4]	730 [28.7]	66.5 [146.3]
FLEX50BY	1352 [53.2]	365 [14.4]	730 [28.7]	71.8 [158]
FLEX50BY.BX	1353 [53.3]	365 [14.4]	730 [28.7]	76.2 [167.6]
FLEX60BY.BX	1608 [63.3]	365 [14.4]	730 [28.7]	90.3 [198.7]
FLEX68BY	1813 [71.4]	365 [14.4]	730 [28.7]	103.6 [227.9]
FLEX68BY.BX	1813 [71.4]	365 [14.4]	730 [28.7]	95.5 [210.1]
FLEX68BY.BX2	1813 [71.4]	365 [14.4]	730 [28.7]	100.2 [220.4]
FLEX78BY.BX2	2068 [81.4]	365 [14.4]	730 [28.7]	114 [250.8]
FLEX86BY	2272 [89.4]	365 [14.4]	730 [28.7]	121.9 [268.2]
FLEX86BY.BX	2272 [89.4]	365 [14.4]	730 [28.7]	125.9 [277]
FLEX86BY.BX2	2272 [89.4]	365 [14.4]	730 [28.7]	119.2 [262.2]
FLEX104BY	2733 [107.6]	365 [14.4]	730 [28.7]	152.9 [336.4]
FLEX104BY.BX	2733 [107.6]	365 [14.4]	730 [28.7]	145.6 [320.3]
FLEX104BY.BX2	2733 [107.6]	365 [14.4]	730 [28.7]	150.1 [330.2]
FLEX122BY	3193 [125.7]	365 [14.4]	730 [28.7]	171.9 [378.2]
FLEX122BY.BX	3193 [125.7]	365 [14.4]	730 [28.7]	176.7 [388.7]
FLEX122BY.BX2	3193 [125.7]	365 [14.4]	730 [28.7]	169.3 [372.5]
FLEX140BY.BX	3653 [143.8]	365 [14.4]	730 [28.7]	195.6 [430.3]
FLEX140BY.BX2	3653 [143.8]	365 [14.4]	730 [28.7]	200.3 [440.7]
FLEX158BY	4113 [161.9]	365 [14.4]	730 [28.7]	228.8 [503.4]
FLEX158BY.BX2	4113 [161.9]	365 [14.4]	730 [28.7]	219.3 [482.5]

* Il peso dell'apparecchio include il / i bruciatore / i (peso a secco escluso il carburante), carbone di legna e vetro. NON include carbone di vetro per scatole laterali.

IMPORTANTE: la cornice sopra l'apparecchio deve essere autoportante. L'apparecchio non è portante.

2. Far scorrere l'apparecchio all'interno della cavità di incorniciatura (la base dell'apparecchio può essere posizionata direttamente sopra il materiale di inquadratura 2 x 4). L'apparecchio viene fornito con staffe di stabilità rosse installate sul / i lato / i aperto / i per mantenere l'apparecchio squadrato durante il trasporto e durante l'installazione. Mantenere la / e staffa / e accesa mentre si incornicia l'impostazione per aiutare a ridurre al minimo il movimento dell'apparecchio.

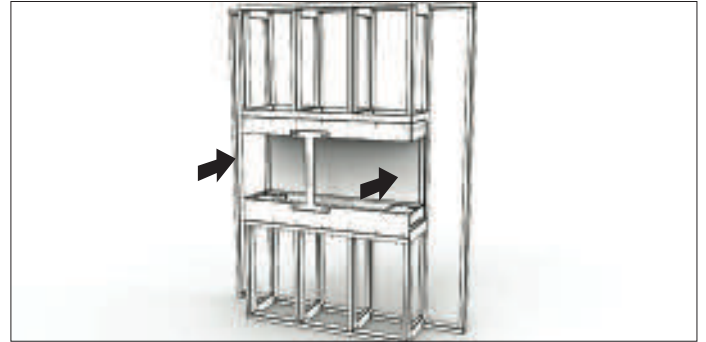

3. Assicurarsi che i bordi sinistro e destro dell'elettrodomestico siano allineati ai perni del telaio.

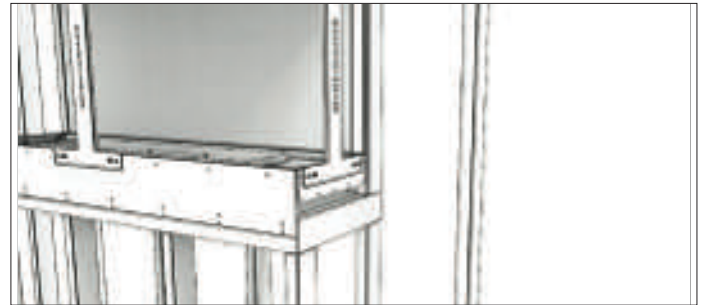

4. Fissare l'apparecchio alla struttura con le viti utilizzando i fori di montaggio esistenti sulle flange dell'apparecchio. Assicurarsi che l'apparecchio sia a livello prima di fissarlo in posizione.

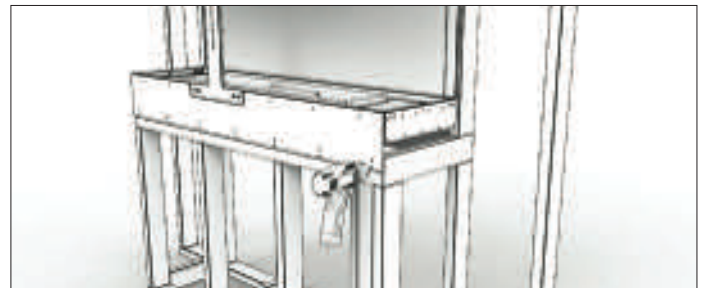

5. Rimuovere le staffe di stabilità rosse.

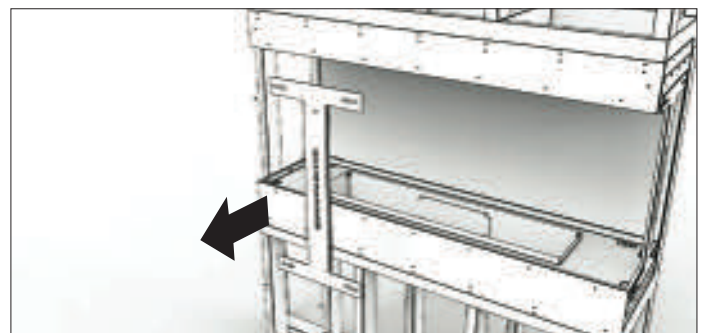

Installazione Bay

90

6. Completare la costruzione rifinendo i pannelli a muro attorno all'apparecchio. (Vedere la sezione sulle **ISTRUZIONI PER LA FINITURA** e assicurarsi di comprendere appieno dove devono essere usati materiali non combustibili.)

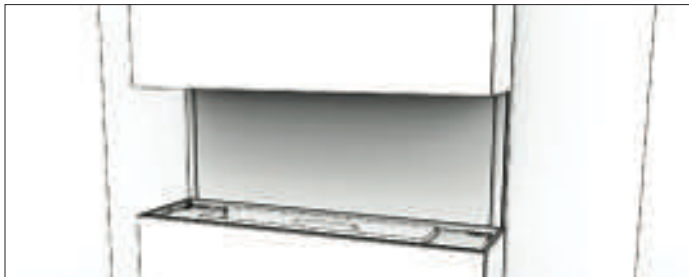

7. Mettere il bruciatore in posizione.

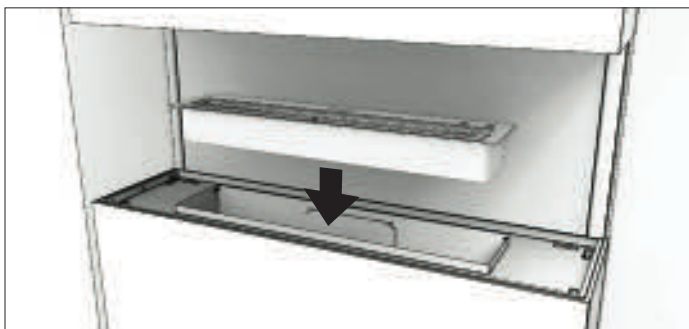

8. Rimuovere il nastro protettivo antipolvere che copre le fessure di montaggio del parabrezza.

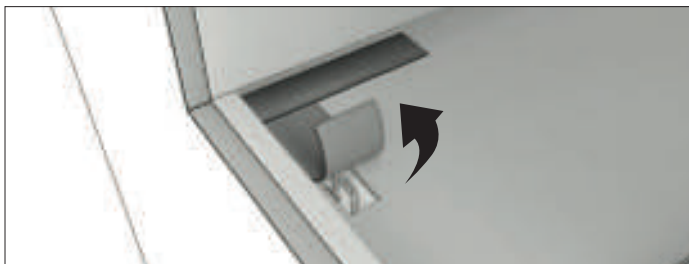

9. Se l'elettrodomestico include un riquadro decorativo a sinistra / a destra o entrambi, inserire il pannello di vetro interno / i alimentando il vetro verso l'alto nello slot, quindi spingendolo verso il basso nelle clip posizionate.

** I ceppi decorativi NON devono essere posti direttamente sopra una fiamma aperta. Sono progettati per sedersi vicino al calore ma non sopra le fiamme.*

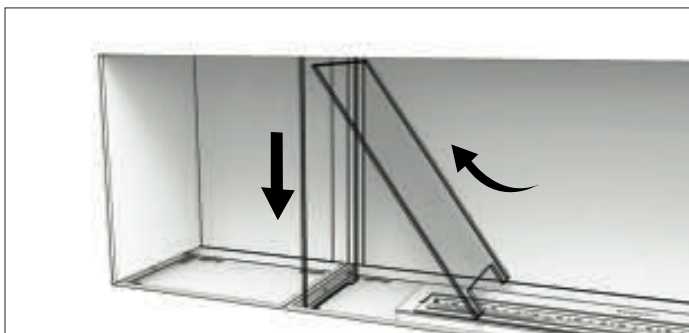

10. Inserire il pannello di vetro a tutta altezza in uno dei lati dell'estremità aperta inserendo il vetro nell'apertura nella parte superiore dell'apparecchio e abbassandolo nelle fessure nella base fino a quando non si posiziona in posizione. Ripetete lo stesso per l'altro lato dell'apparecchio.

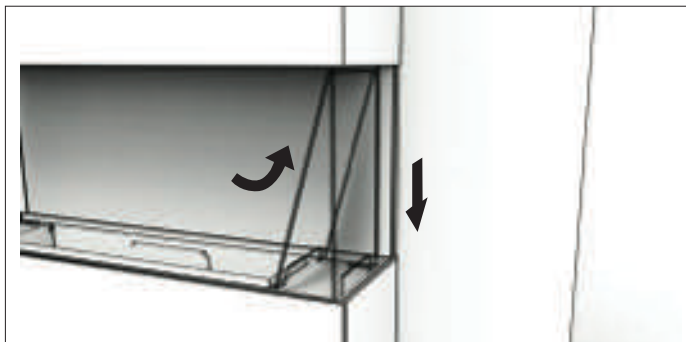

11. Installare il parabrezza inserendo le due estremità nelle apposite fessure nell'apparecchio. Utilizzare una piccola quantità di pressione per spingere il parabrezza in posizione fino a quando raggiunge il fondo nelle clip di vetro nascoste.

AVVERTENZA: il vetro utilizzato è in vetro temperato, il che significa che è più resistente del normale vetro. È importante sottolineare che, anche se è più forte, il vetro temprato ha ancora punti deboli. Gli angoli e i lati sono punti di pressione specifici dove è più fragile e possono rompersi se non si presta attenzione. Il vetro si rompe in molti piccoli pezzi. Fare attenzione per evitare tagli. Si consiglia di indossare guanti protettivi quando si maneggia il vetro.

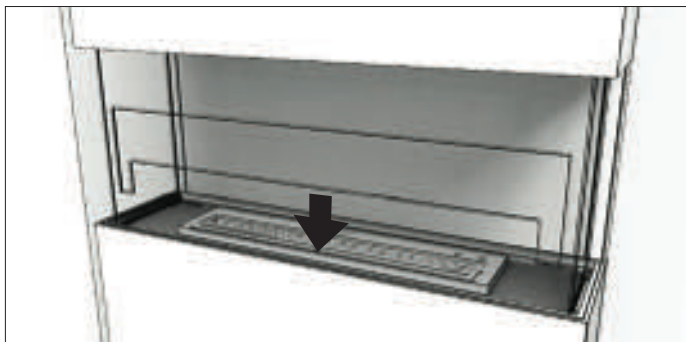

12. Stendere il carbone di vetro in modo uniforme attorno al vassoio dell'apparecchio. **ATTENZIONE:** assicurarsi che il coperchio del bruciatore sia chiuso. Tenere il carbone di vetro lontano dalla flangia del bruciatore per evitare che il carbone di vetro entri accidentalmente nella camera del bruciatore. Fare attenzione a non graffiare il bruciatore.

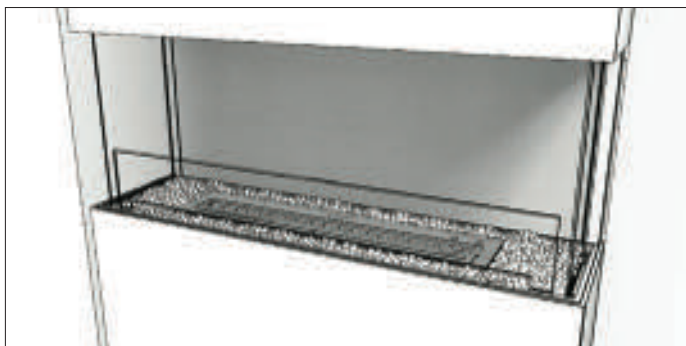

Installazione a Due Lati

Attrezzatura necessaria: trapano elettrico, cacciavite, livella, cazzuola, pistola siliconica, pistola per calafataggio

1. Costruire la struttura della parete principale con le dimensioni di apertura mostrate nella Tabella D. La base del telaio può essere una panca / piattaforma solida, che aiuterà a livellare l'apparecchio quando è in posizione.

AVVERTENZA: gli apparecchi a doppia faccia non possono essere inseriti in una parete a cavità unidirezionale, deve essere una cavità a due vie in cui il vetro su entrambi i lati è libero da ostacoli. Non applicare pressione o materiali sul vetro. Gli apparecchi bifacciali sono progettati come inserti divisori per pareti. Se non si rispettano le istruzioni di installazione, il muro potrebbe surriscaldarsi e prendere fuoco.



Tabella D: Dimensioni iniziali di apertura

Le dimensioni dell'apparecchio devono essere verificate rispetto alle dimensioni tagliate PRIMA che l'installazione abbia inizio per confermare le tolleranze allineate.

APPARECCHIO	L mm [in]	P mm [in]	A mm [in]	Peso* kg [lbs]
FLEX18DB	488 [19.2]	349 [13.6]	730 [28.7]	26.5 [58.3]
FLEX32DB	922 [36.3]	349 [13.6]	730 [28.7]	46.6 [102.5]
FLEX42DB	1177 [46.3]	349 [13.6]	730 [28.7]	61.4 [135.1]
FLEX50DB	1380 [54.3]	349 [13.6]	730 [28.7]	70.8 [155.8]
FLEX50DB.BX	1380 [54.3]	349 [13.6]	730 [28.7]	70 [154]
FLEX60DB.BX	1634 [64.3]	349 [13.6]	730 [28.7]	83.3 [183.3]
FLEX68DB	1840 [72.4]	349 [13.6]	730 [28.7]	95.5 [210.1]
FLEX68DB.BX	1840 [72.4]	349 [13.6]	730 [28.7]	83.7 [184.1]
FLEX68DB.BX2	1840 [72.4]	349 [13.6]	730 [28.7]	94.8 [208.6]
FLEX78DB.BX2	2090 [82.3]	349 [13.6]	730 [28.7]	106.2 [233.6]
FLEX86DB	2300 [90.5]	349 [13.6]	730 [28.7]	102.3 [225.1]
FLEX86DB.BX	2300 [90.5]	349 [13.6]	730 [28.7]	124.5 [273.9]
FLEX86DB.BX2	2300 [90.5]	349 [13.6]	730 [28.7]	108.5 [238.7]
FLEX104DB	2760 [108.7]	349 [13.6]	730 [28.7]	145.7 [320.5]
FLEX104DB.BX	2760 [108.7]	349 [13.6]	730 [28.7]	127.1 [279.6]
FLEX104DB.BX2	2760 [108.7]	349 [13.6]	730 [28.7]	142 [312]
FLEX122DB	3220 [126.7]	349 [13.6]	730 [28.7]	145.6 [320.3]
FLEX122DB.BX	3220 [126.7]	349 [13.6]	730 [28.7]	170.1 [374.2]
FLEX122DB.BX2	3220 [126.7]	349 [13.6]	730 [28.7]	151.9 [334.2]
FLEX140DB.BX	3680 [144.9]	349 [13.6]	730 [28.7]	170.4 [374.9]
FLEX140DB.BX2	3680 [144.9]	349 [13.6]	730 [28.7]	192.9 [424.4]
FLEX158DB	4140 [163]	349 [13.6]	730 [28.7]	226.8 [499]
FLEX158DB.BX2	4140 [163]	349 [13.6]	730 [28.7]	195.2 [429.4]

* Il peso dell'apparecchio include il / i bruciatore / i (peso a secco escluso il carburante), carbone di legna e vetro. NON include carbone di vetro per scatole laterali.

IMPORTANTE: la cornice sopra l'apparecchio deve essere autoportante. L'apparecchio non è portante.

2. Rimuovere la flangia di estensione dal caminetto in modo che entrambi i lati abbiano la stessa altezza. Ciò contribuirà a rendere più scorrevole il camino nel telaio. Fare attenzione a non perdere le viti, saranno nuovamente necessarie quando la flangia viene reinstallata.



3. Far scorrere l'apparecchio all'interno della cavità di incorniciatura (il vassoio inferiore può essere posizionato direttamente sopra il telaio). L'apparecchio viene fornito con staffe di stabilità rosse installate sul / i lato / i aperto / i per mantenere l'apparecchio squadrato durante il trasporto e durante l'installazione. Mantenere la / e staffa / e accesa mentre si incornicia l'impostazione per aiutare a ridurre al minimo il movimento dell'apparecchio.

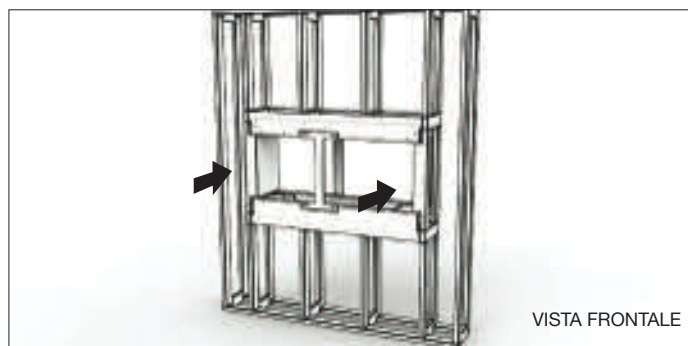

4. Allineare il pannello di estensione della flangia con i fori filettati sull'apparecchio. Avvitarlo in posizione usando le viti in dotazione (la fila in basso sull'apparecchio, la fila superiore sul materiale per incorniciare) per fissarlo in posizione.

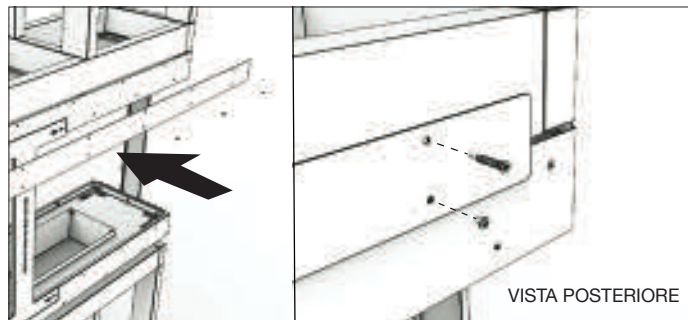

5. Fissare l'apparecchio alla struttura con le viti utilizzando i fori di montaggio esistenti sulle flange dell'apparecchio. Assicurarsi che l'apparecchio sia a livello prima di fissarlo in posizione.



Installazione a Due Lati

92

6. Rimuovere le staffe di stabilità rosse.

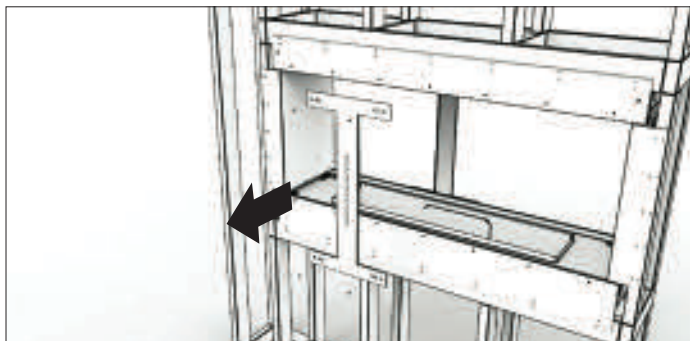

7. Completare la costruzione rifinendo i pannelli a muro attorno all'apparecchio. (Vedere la sezione sulle **ISTRUZIONI PER LA FINITURA** e assicurarsi di comprendere appieno dove devono essere usati materiali non combustibili.)



8. Mettere il bruciatore in posizione.

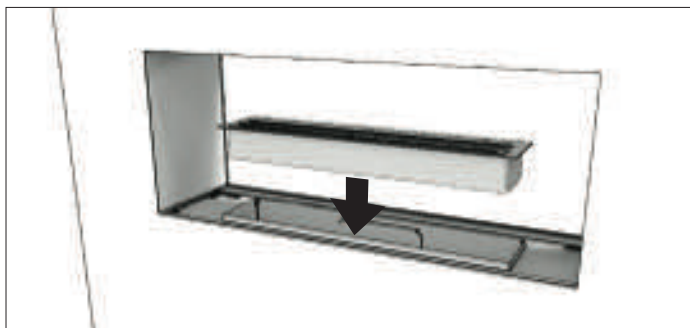

9. Rimuovere il nastro protettivo antipolvere che copre le fessure di montaggio del parabrezza.

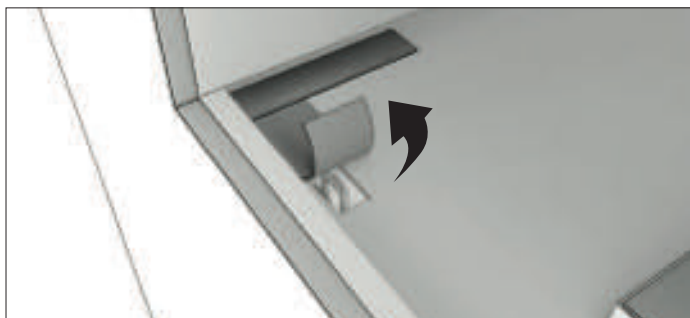

10. Se l'elettrodomestico include un riquadro decorativo a sinistra / a destra o entrambi, inserire il pannello di vetro interno / i alimentando il vetro verso l'alto nello slot, quindi spingendolo verso il basso nelle clip posizionate.

** I ceppi decorativi NON devono essere posti direttamente sopra una fiamma aperta. Sono progettati per sedersi vicino al calore ma non sopra le fiamme.*

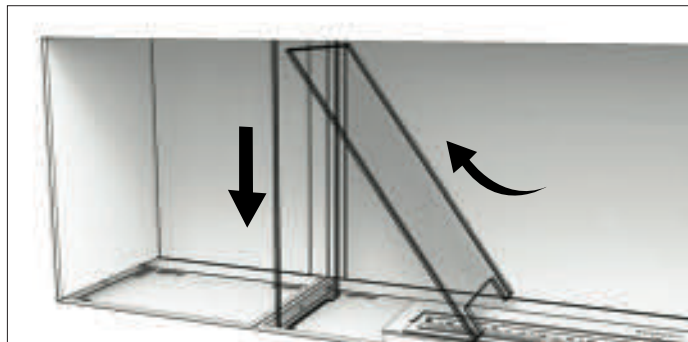

11. Installare il parabrezza inserendo le due estremità nelle apposite fessure nell'apparecchio. Utilizzare una piccola quantità di pressione per spingere il parabrezza in posizione fino a quando raggiunge il fondo nelle clip di vetro nascoste.

AVVERTENZA: il vetro utilizzato è in vetro temperato, il che significa che è più resistente del normale vetro. È importante sottolineare che, anche se è più forte, il vetro temprato ha ancora punti deboli. Gli angoli e i lati sono punti di pressione specifici dove è più fragile e possono rompersi se non si presta attenzione. Il vetro si rompe in molti piccoli pezzi. Fare attenzione per evitare tagli. Si consiglia di indossare guanti protettivi quando si maneggia il vetro.



12. Stendere il carbone di vetro in modo uniforme attorno al vassoio dell'apparecchio. **ATTENZIONE:** assicurarsi che il coperchio del bruciatore sia chiuso. Tenere il carbone di vetro lontano dalla flangia del bruciatore per evitare che il carbone di vetro entri accidentalmente nella camera del bruciatore. Fare attenzione a non graffiare il bruciatore.



Installazione Penisola

93

Attrezzatura necessaria: trapano elettrico, cacciavite, livella, cazzuola, pistola silconica, pistola per calafataggio

1. Costruire la struttura della parete principale con le dimensioni di apertura mostrate nella Tabella E. La base del telaio può essere una panca / piattaforma solida, che aiuterà a livellare l'apparecchio quando è in posizione.

AVVERTENZA: gli apparecchi a tre lati non possono essere inseriti in una parete a cavità unidirezionale, deve essere una cavità a due vie in cui il vetro su tutti i lati è libero da ostacoli. Non applicare pressione o materiali sul vetro. Gli apparecchi tripli sono progettati come inserti divisori. Se non si rispettano le istruzioni di installazione, il muro potrebbe surriscaldarsi e prendere fuoco.



Tabella E: Dimensioni iniziali di apertura

Le dimensioni dell'apparecchio devono essere verificate rispetto alle dimensioni tagliate PRIMA che l'installazione abbia inizio per confermare le tolleranze allineate.

APPARECCHIO	L mm [in]	P mm [in]	A mm [in]	Peso* kg [lbs]
FLEX18PN	470 [18.5]	349 [13.6]	730 [28.7]	34.2 [75.2]
FLEX32PN	902 [35.5]	349 [13.6]	730 [28.7]	49.8 [109.6]
FLEX42PN	1157 [45.5]	349 [13.6]	730 [28.7]	64.7 [142.3]
FLEX50PN	1362 [53.6]	349 [13.6]	730 [28.7]	59.1 [130]
FLEX50PN.BX	1362 [53.6]	349 [13.6]	730 [28.7]	73.2 [161]
FLEX60PN.BX	1617 [63.7]	349 [13.6]	730 [28.7]	87.5 [192.5]
FLEX68PN	1822 [71.7]	349 [13.6]	730 [28.7]	102.8 [226.2]
FLEX68PN.BX	1822 [71.7]	349 [13.6]	730 [28.7]	83.9 [184.6]
FLEX68PN.BX2	1822 [71.7]	349 [13.6]	730 [28.7]	96.1 [211.4]
FLEX78PN.BX2	2077 [81.8]	349 [13.6]	730 [28.7]	110.4 [242.9]
FLEX86PN	2282 [89.8]	349 [13.6]	730 [28.7]	102.5 [225.5]
FLEX86PN.BX	2282 [89.8]	349 [13.6]	730 [28.7]	124.1 [273]
FLEX86PN.BX2	2282 [89.8]	349 [13.6]	730 [28.7]	108.7 [239.1]
FLEX104PN	2742 [107.9]	349 [13.6]	730 [28.7]	153.3 [337.3]
FLEX104PN.BX	2742 [107.9]	349 [13.6]	730 [28.7]	127.3 [280.1]
FLEX104PN.BX2	2742 [107.9]	349 [13.6]	730 [28.7]	147.3 [324.1]
FLEX122PN	3202 [126.1]	349 [13.6]	730 [28.7]	145.8 [320.8]
FLEX122PN.BX	3202 [126.1]	349 [13.6]	730 [28.7]	176.2 [387.6]
FLEX122PN.BX2	3202 [126.1]	349 [13.6]	730 [28.7]	152.1 [334.6]
FLEX140PN.BX	3662 [144.2]	349 [13.6]	730 [28.7]	170.6 [375.3]
FLEX140PN.BX2	3662 [144.2]	349 [13.6]	730 [28.7]	198.7 [437.1]
FLEX158PN	4122 [162.3]	349 [13.6]	730 [28.7]	231.8 [510]
FLEX158PN.BX2	4122 [162.3]	349 [13.6]	730 [28.7]	195.4 [429.9]

* Il peso dell'apparecchio include il / i bruciatore / i (peso a secco escluso il carburante), carbone di legna e vetro. NON include carbone di vetro per scatole laterali.

IMPORTANTE: la cornice sopra l'apparecchio deve essere autoportante. L'apparecchio non è portante.

2. Rimuovere la flangia di estensione dal caminetto in modo che entrambi i lati abbiano la stessa altezza. Ciò contribuirà a rendere più scorrevole il camino nel telaio. Fare attenzione a non perdere le viti, saranno nuovamente necessarie quando la flangia viene reinstallata.



3. Far scorrere l'apparecchio all'interno della cavità di incorniciatura (il vassoio inferiore può essere posizionato direttamente sopra il telaio). L'apparecchio viene fornito con staffe di stabilità rosse installate sul / i lato / i aperto / i per mantenere l'apparecchio squadrato durante il trasporto e durante l'installazione. Mantenere la / e staffa / e accesa mentre si incornicia l'impostazione per aiutare a ridurre al minimo il movimento dell'apparecchio.

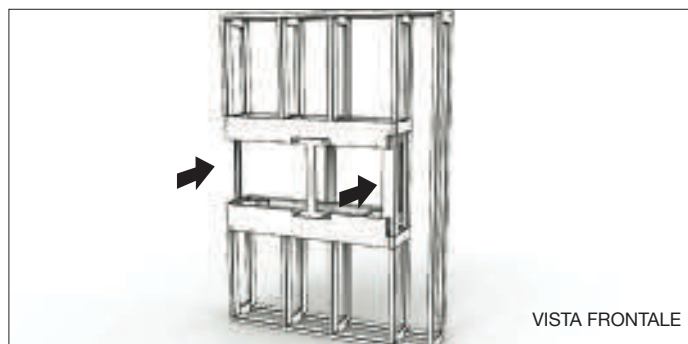

4. Assicurarsi che il lato posteriore e il bordo laterale aperto dell'apparecchio siano a livello dei perni del telaio.

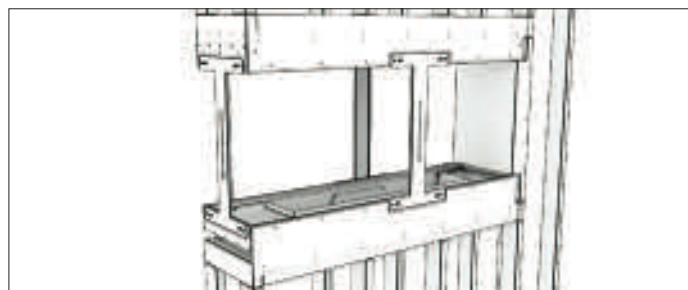

5. Allineare il pannello di estensione della flangia con i fori filettati sull'apparecchio. Avvitarlo in posizione usando le viti in dotazione (la fila in basso sull'apparecchio, la fila superiore sul materiale per incorniciare) per fissarlo in posizione.



Installazione Penisola

6. Fissare l'apparecchio alla struttura con le viti utilizzando i fori di montaggio esistenti sulle flange dell'apparecchio. Assicurarsi che l'apparecchio sia a livello prima di fissarlo in posizione.

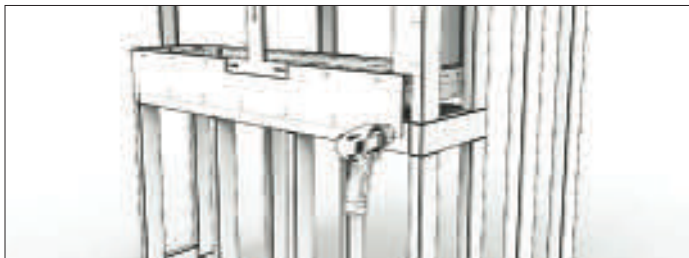

7. Rimuovere le staffe di stabilità rosse.

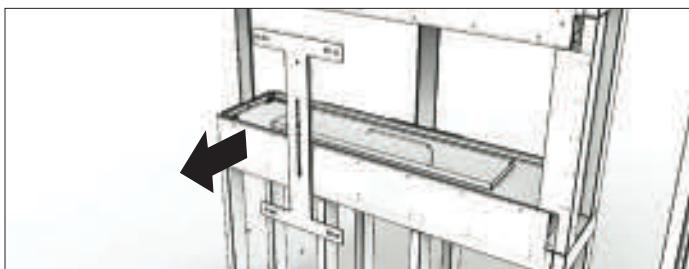

8. Completare la costruzione refinendo i pannelli a muro attorno all'apparecchio. (Vedere la sezione sulle **ISTRUZIONI PER LA FINITURA** e assicurarsi di comprendere appieno dove devono essere usati materiali non combustibili.)



9. Mettere il bruciatore in posizione.

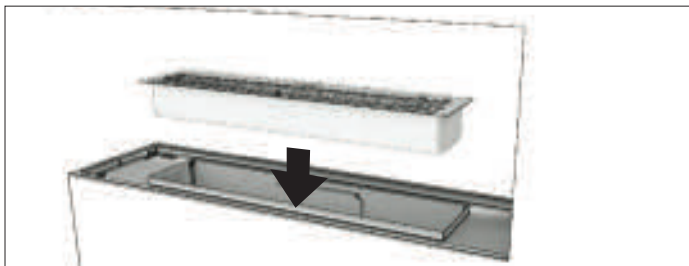

10. Rimuovere il nastro protettivo antipolvere che copre le fessure di montaggio del parabrezza.

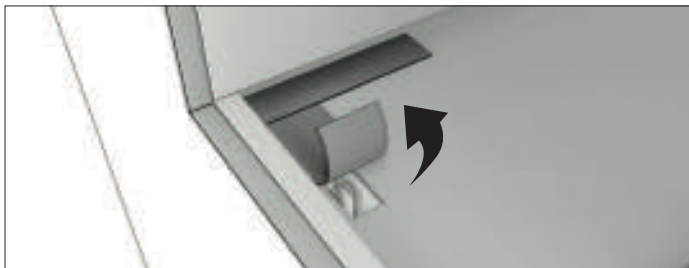

11. Se l'elettrodomestico include un riquadro decorativo a sinistra / a destra o entrambi, inserire il pannello di vetro interno / i alimentando il vetro verso l'alto nello slot, quindi spingendolo verso il basso nelle clip posizionate.

** I ceppi decorativi NON devono essere posti direttamente sopra una fiamma aperta. Sono progettati per sedersi vicino al calore ma non sopra le fiamme.*

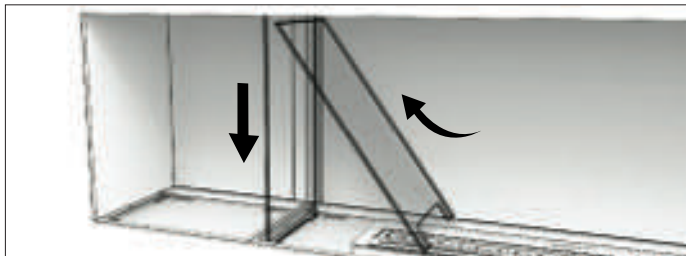

12. Inserire il pannello di vetro a tutta altezza nel lato dell'estremità aperta inserendo il vetro nell'apertura nella parte superiore dell'apparecchio e abbassandolo nelle fessure nella base finché non si posiziona in posizione.

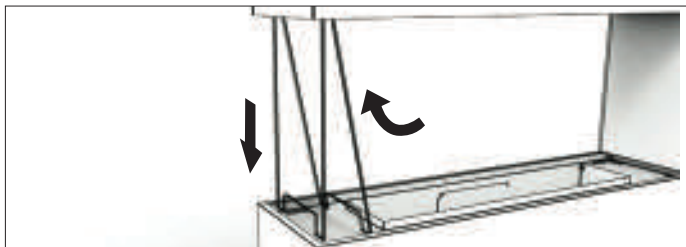

13. Installare il parabrezza inserendo le due estremità nelle apposite fessure nell'apparecchio. Utilizzare una piccola quantità di pressione per spingere il parabrezza in posizione fino a quando raggiunge il fondo nelle clip di vetro nascoste.

AVVERTENZA: il vetro utilizzato è in vetro temperato, il che significa che è più resistente del normale vetro. È importante sottolineare che, anche se è più forte, il vetro temprato ha ancora punti deboli. Gli angoli e i lati sono punti di pressione specifici dove è più fragile e possono rompersi se non si presta attenzione. Il vetro si rompe in molti piccoli pezzi. Fare attenzione per evitare tagli. Si consiglia di indossare guanti protettivi quando si maneggia il vetro.

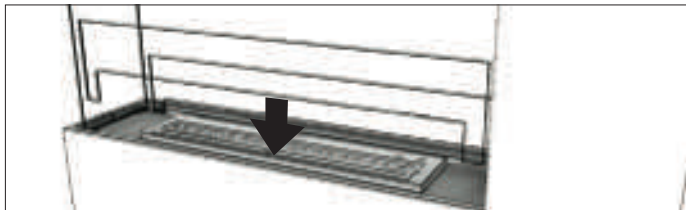

14. Stendere il carbone di vetro in modo uniforme attorno al vassoio dell'apparecchio. **ATTENZIONE:** assicurarsi che il coperchio del bruciatore sia chiuso. Tenere il carbone di vetro lontano dalla flangia del bruciatore per evitare che il carbone di vetro entri accidentalmente nella camera del bruciatore. Fare attenzione a non graffiare il bruciatore.

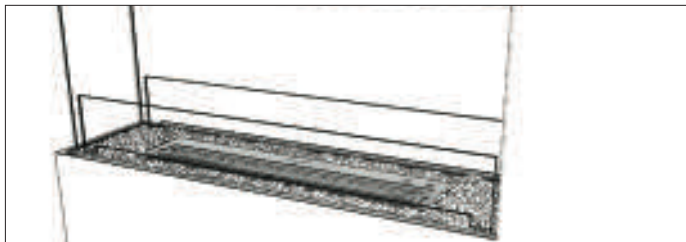

Installazione a Isola

Attrezzatura necessaria: trapano elettrico, cacciavite, livella, cazzuola, pistola siliconica, pistola per calafataggio

1. Costruire la struttura con le dimensioni di apertura mostrate nella Tavola F. La base del telaio può essere una panca / piattaforma solida, che aiuterà a livellare l'apparecchio quando è in posizione.

AVVERTENZA: Questo dispositivo a quattro lati non può venire inserito in una struttura muraria. Deve venire installato su una struttura separata saldamente ancorata al pavimento. Non installare su struttura mobile o debole. La parte superiore dell'apparecchio deve venire installata su una struttura saldata al soffitto e allineata con la cornice inferiore. I dispositivi a quattro lati sono concepiti come inserti da divisori di muri. Se non si rispettano le istruzioni di installazione, il muro potrebbe surriscaldarsi e prendere fuoco.



Tavola F: Dimensioni iniziali di apertura

Le dimensioni dell'apparecchio devono essere verificate rispetto alle dimensioni tagliate PRIMA che l'installazione abbia inizio per confermare le tolleranze allineate.

APPARECCHIO	L mm [in]	P mm [in]	A mm [in]	Peso* kg [lbs]
FLEX18IL	455 [17.9]	349 [13.6]	730 [28.7]	22.2 [48.9]
FLEX32IL	887 [34.9]	349 [13.6]	730 [28.7]	33.5 [73.7]
FLEX42IL	1142 [45]	349 [13.6]	730 [28.7]	49.8 [109.6]
FLEX50IL	1347 [53]	349 [13.6]	730 [28.7]	59.9 [131.8]
FLEX50IL.BX	1347 [53]	349 [13.6]	730 [28.7]	48.3 [106.3]
FLEX60IL.BX	1602 [63.1]	349 [13.6]	730 [28.7]	64.6 [142.2]
FLEX68IL	1807 [71.1]	349 [13.6]	730 [28.7]	75.2 [165.5]
FLEX68IL.BX	1807 [71.1]	349 [13.6]	730 [28.7]	74.7 [164.4]
FLEX68IL.BX2	1807 [71.1]	349 [13.6]	730 [28.7]	63.1 [138.9]
FLEX78IL.BX2	2062 [81.2]	349 [13.6]	730 [28.7]	79.4 [174.8]
FLEX86IL	2267 [89.3]	349 [13.6]	730 [28.7]	101.5 [223.2]
FLEX86IL.BX	2267 [89.3]	349 [13.6]	730 [28.7]	90 [198.1]
FLEX86IL.BX2	2267 [89.3]	349 [13.6]	730 [28.7]	89.5 [197]
FLEX104IL	2727 [107.4]	349 [13.6]	730 [28.7]	116.3 [255.9]
FLEX104IL.BX	2727 [107.4]	349 [13.6]	730 [28.7]	116.3 [255.9]
FLEX104IL.BX2	2727 [107.4]	349 [13.6]	730 [28.7]	104.8 [230.6]
FLEX122IL	3187 [125.5]	349 [13.6]	730 [28.7]	148.6 [327]
FLEX122IL.BX	3187 [125.5]	349 [13.6]	730 [28.7]	131.1 [288.4]
FLEX122IL.BX2	3187 [125.5]	349 [13.6]	730 [28.7]	131.1 [288.4]
FLEX140IL.BX	3647 [143.6]	349 [13.6]	730 [28.7]	163.4 [359.6]
FLEX140IL.BX2	3647 [143.6]	349 [13.6]	730 [28.7]	145.9 [321.1]
FLEX158IL	4107 [161.7]	349 [13.6]	730 [28.7]	173.9 [382.6]
FLEX158IL.BX2	4107 [161.7]	349 [13.6]	730 [28.7]	178.3 [392.2]

* Il peso dell'apparecchio include il / i bruciatore / i (peso a secco escluso il carburante), carbone di legna e vetro. NON include carbone di vetro per scatole laterali.

IMPORTANTE: la cornice sopra l'apparecchio deve essere autoportante. L'apparecchio non è portante.

2. Rimuovere la flangia di estensione dal caminetto in modo che entrambi i lati abbiano la stessa altezza. Ciò contribuirà a rendere più scorrevole il camino nel telaio. Fare attenzione a non perdere le viti, saranno nuovamente necessarie quando la flangia viene reinstallata.

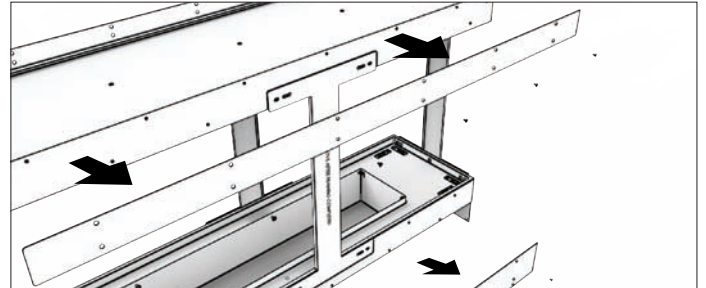

3. Far scorrere l'apparecchio all'interno della cavità di incorniciatura (il vassoio inferiore può essere posizionato direttamente sopra il telaio). L'apparecchio viene fornito con staffe di stabilità rosse installate sul / i lato / i aperto / i per mantenere l'apparecchio squadrato durante il trasporto e durante l'installazione. Mantenere la / e staffa / e accesa mentre si incornicia l'impostazione per aiutare a ridurre al minimo il movimento dell'apparecchio.

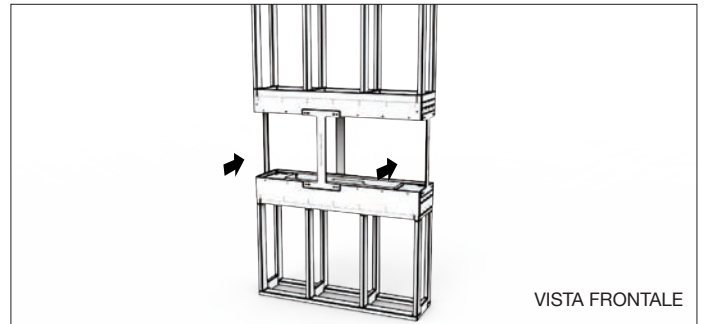

4. Allineare il pannello di estensione della flangia con i fori filettati sull'apparecchio. Avvitarlo in posizione usando le viti in dotazione (la fila in basso sull'apparecchio, la fila superiore sul materiale per incorniciare) per fissarlo in posizione.

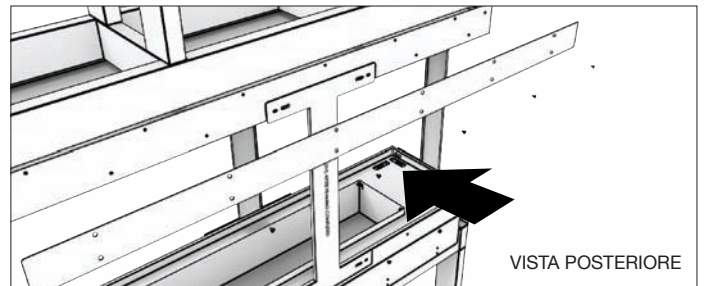

5. Fissare l'apparecchio alla struttura con le viti utilizzando i fori di montaggio esistenti sulle flange dell'apparecchio. Assicurarsi che l'apparecchio sia a livello prima di fissarlo in posizione.

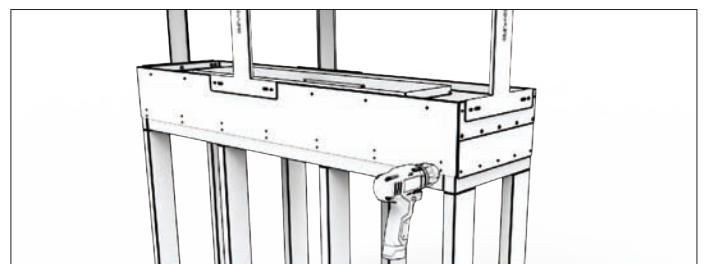

6. Rimuovere le staffe di stabilità rosse.

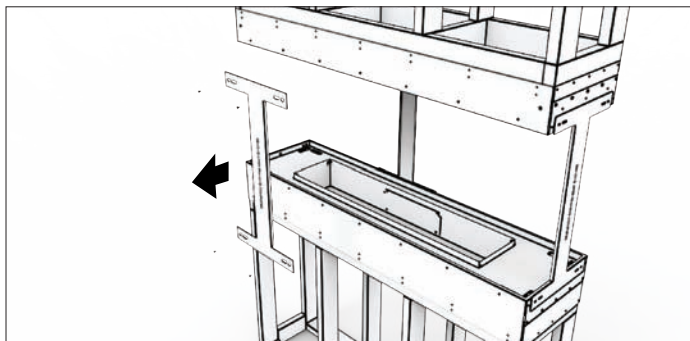

7. Completare la costruzione rifinendo i pannelli a muro attorno all'apparecchio. (Vedere la sezione sulle **ISTRUZIONI PER LA FINITURA** e assicurarsi di comprendere appieno dove devono essere usati materiali non combustibili.)

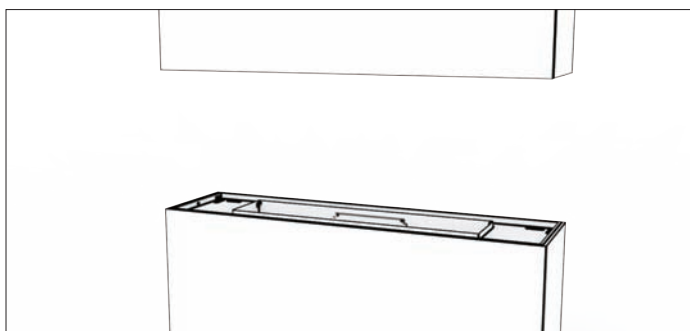

8. Mettere il bruciatore in posizione.

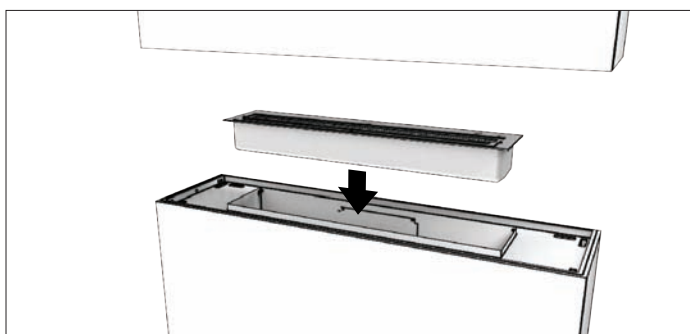

9. Rimuovere il nastro protettivo antipolvere che copre le fessure di montaggio del parabrezza.

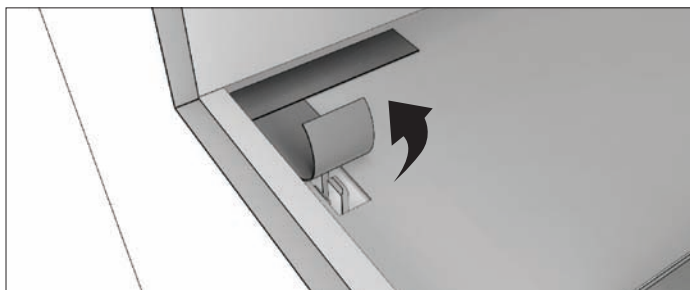

10. Installare il parabrezza inserendo le due estremità nelle apposite fessure nell'apparecchio. Utilizzare una piccola quantità di pressione per spingere il parabrezza in posizione fino a quando raggiunge il fondo nelle clip di vetro nascoste. Ripetere lo stesso per il parabrezza del retro e se il tuo dispositivo comprende una scatola decorativa e sinistra / a destra o entrambe.

** I ceppi decorativi NON devono essere posti direttamente sopra una fiamma aperta. Sono progettati per sedersi vicino al calore ma non sopra le fiamme. Per questo modello serve solo un set di ceppi decorativi.*

AVVERTENZA: il vetro utilizzato è in vetro temperato, il che significa che è più resistente del normale vetro. È importante sottolineare che, anche se è più forte, il vetro temprato ha ancora punti deboli. Gli angoli e i lati sono punti di pressione specifici dove è più fragile e possono rompersi se non si presta attenzione. Il vetro si rompe in molti piccoli pezzi. Fare attenzione per evitare tagli. Si consiglia di indossare guanti protettivi quando si maneggia il vetro.

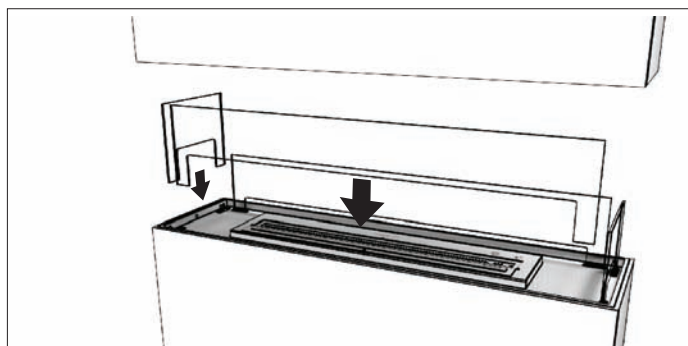

11. Stendere il carbone di vetro in modo uniforme attorno al vassoio dell'apparecchio. **ATTENZIONE:** assicurarsi che il coperchio del bruciatore sia chiuso. Tenere il carbone di vetro lontano dalla flangia del bruciatore per evitare che il carbone di vetro entri accidentalmente nella camera del bruciatore. Fare attenzione a non graffiare il bruciatore.

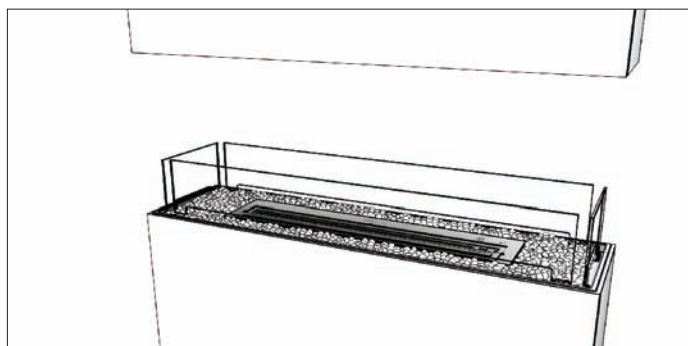

Installazione a Banco

Attrezzatura necessaria: trapano elettrico, cacciavite, livella, cazzuola, pistola siliconica, pistola per calafataggio

1. Costruire la struttura principale usando le dimensioni mostrate nella Tavola G. La base del telaio può essere una panca / piattaforma solida, che aiuterà a livellare l'apparecchio quando è in posizione. Nel progettare la costruzione, assicurarsi che in alto ci sia uno spazio minimo di 1500mm (59.1") dall'apertura del bruciatore al soffitto.

AVVERTENZA: Questo dispositivo a quattro lati non può venire inserito in una struttura muraria. Deve venire installato su una struttura separata saldamente ancorata al pavimento. Non installare su strutture mobili o deboli. I dispositivi a quattro lati sono progettati come divisori a parete. Se non si è conformi a queste istruzioni, la struttura potrebbe surriscaldarsi e prendere fuoco.



Tabella G: Dimensioni delle Strutture

Le dimensioni dell'apparecchio devono essere verificate rispetto alle dimensioni tagliate PRIMA che l'installazione abbia inizio per confermare le tolleranze allineate.

APPARECCHIO	L mm [in]	P mm [in]	Peso* kg [lbs]
FLEX18BN	455 [17.9]	349 [13.6]	18.3 [40.2]
FLEX32BN	887 [34.9]	349 [13.6]	27.5 [60.6]
FLEX42BN	1142 [45]	349 [13.6]	33.8 [74.4]
FLEX50BN	1347 [53]	349 [13.6]	39.5 [86.9]
FLEX50BN.BX	1347 [53]	349 [13.6]	38.4 [84.5]
FLEX60BN.BX	1602 [63.1]	349 [13.6]	44.7 [98.4]
FLEX68BN	1807 [71.1]	349 [13.6]	50.3 [110.6]
FLEX68BN.BX	1807 [71.1]	349 [13.6]	61.1 [134.5]
FLEX68BN.BX2	1807 [71.1]	349 [13.6]	49.3 [108.5]
FLEX78BN.BX2	2062 [81.2]	349 [13.6]	55.6 [122.4]
FLEX86BN	2267 [89.3]	349 [13.6]	71.6 [157.5]
FLEX86BN.BX	2267 [89.3]	349 [13.6]	61.1 [134.5]
FLEX86BN.BX2	2267 [89.3]	349 [13.6]	61.3 [134.8]
FLEX104BN	2727 [107.4]	349 [13.6]	80 [176]
FLEX104BN.BX	2727 [107.4]	349 [13.6]	82.5 [181.5]
FLEX104BN.BX2	2727 [107.4]	349 [13.6]	72 [158.5]
FLEX122BN	3187 [125.5]	349 [13.6]	105.6 [232.4]
FLEX122BN.BX	3187 [125.5]	349 [13.6]	90.9 [200]
FLEX122BN.BX2	3187 [125.5]	349 [13.6]	93.4 [205.5]
FLEX140BN.BX	3647 [143.6]	349 [13.6]	116.5 [256.3]
FLEX140BN.BX2	3647 [143.6]	349 [13.6]	101.8 [224]
FLEX158BN	4107 [161.7]	349 [13.6]	118.8 [261.4]
FLEX158BN.BX2	4107 [161.7]	349 [13.6]	127.4 [280.3]

* Il peso dell'apparecchio include il / i bruciatore / i (peso a secco escluso il carburante), carbone di legna e vetro. NON include carbone di vetro per scatole laterali.

2. Rimuovere la flangia di estensione dal caminetto in modo che entrambi i lati abbiano la stessa altezza. Ciò contribuirà a rendere più scorrevole il camino nel telaio. Fare attenzione a non perdere le viti, saranno nuovamente necessarie quando la flangia viene reinstallata.

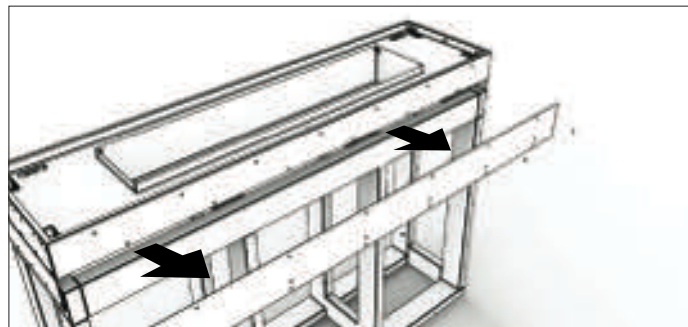

3. Far scorrere l'apparecchio all'interno della cavità di incorniciatura (il vassoio inferiore può essere posizionato direttamente sopra il telaio).

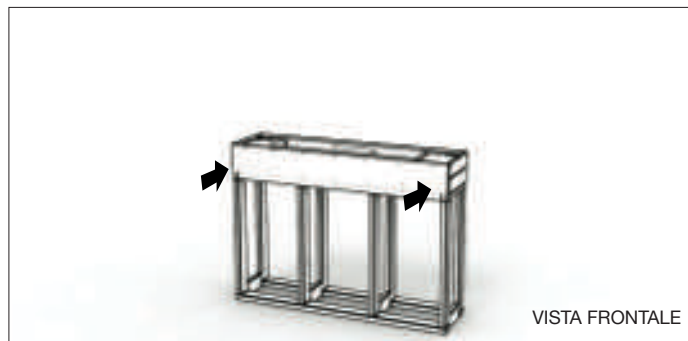

4. Allineare il pannello di estensione della flangia con i fori filettati sull'apparecchio. Avvitarlo in posizione usando le viti in dotazione (la fila in basso sull'apparecchio, la fila superiore sul materiale per incorniciare) per fissarlo in posizione.

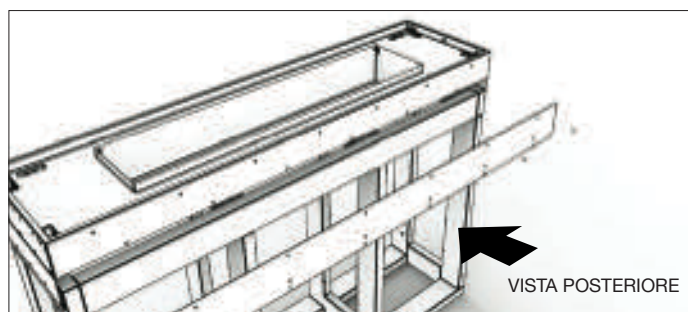

5. Fissare l'apparecchio alla struttura con le viti utilizzando i fori di montaggio esistenti sulle flange dell'apparecchio. Assicurarsi che l'apparecchio sia a livello prima di fissarlo in posizione.



Installazione a Banco

6. Completare la costruzione rifinendo i pannelli a muro attorno all'apparecchio. (Vedere la sezione sulle **ISTRUZIONI PER LA FINITURA** e assicurarsi di comprendere appieno dove devono essere usati materiali non combustibili.)



7. Mettere il bruciatore in posizione.



8. Rimuovere il nastro protettivo antipolvere che copre le fessure di montaggio del parabrezza.

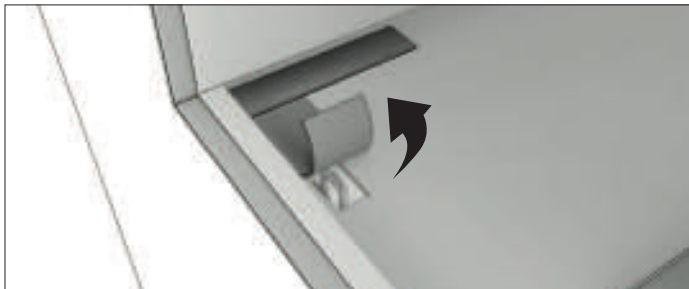

9. Installare il parabrezza inserendo le due estremità nelle apposite fessure nell'apparecchio. Utilizzare una piccola quantità di pressione per spingere il parabrezza in posizione fino a quando raggiunge il fondo nelle clip di vetro nascoste. Ripetere lo stesso per il parabrezza del retro e se il tuo dispositivo comprende una scatola decorativa e sinistra / a destra o entrambe.

** I ceppi decorativi NON devono essere posti direttamente sopra una fiamma aperta. Sono progettati per sedersi vicino al calore ma non sopra le fiamme. Per questo modello serve solo un set di ceppi decorativi.*

AVVERTENZA: il vetro utilizzato è in vetro temperato, il che significa che è più resistente del normale vetro. È importante sottolineare che, anche se è più forte, il vetro temprato ha ancora punti deboli. Gli angoli e i lati sono punti di pressione specifici dove è più fragile e possono rompersi se non si presta attenzione. Il vetro si rompe in molti piccoli pezzi. Fare attenzione per evitare tagli. Si consiglia di indossare guanti protettivi quando si maneggia il vetro.

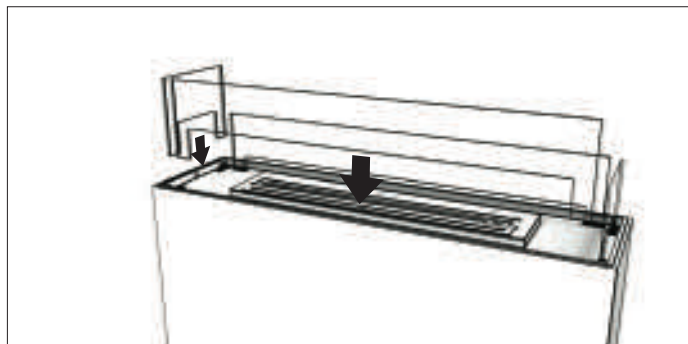

10. Stendere il carbone di vetro in modo uniforme attorno al vassoio dell'apparecchio. **ATTENZIONE:** assicurarsi che il coperchio del bruciatore sia chiuso. Tenere il carbone di vetro lontano dalla flangia del bruciatore per evitare che il carbone di vetro entri accidentalmente nella camera del bruciatore. Fare attenzione a non graffiare il bruciatore.



1. Applicare i pannelli delle pareti circostanti. Si possono usare materiali come pannello in fibra-cemento, pannello antincendio di media densità con indicazione del livello di resistenza del fuoco (FR MDF), pietra, mattonelle, acciaio, e cartongesso con indicazione del livello di resistenza del fuoco (FR).

I materiali di rivestimento o finitura non devono mai sporgere nell'apertura dell'apparecchio.

AVVERTIMENTO! Rischio di incendio! Non applicare materiali combustibili oltre le distanze minime. Rispettare tutte le distanze minime dai combustibili come specificato in questo manuale e nel manuale del bruciatore.

IMPORTANTE: un pannello non combustibile da 155 mm [6 "] deve essere installato sopra tutti i lati delle aperture dell'apparecchio. Vedere esempi sotto.



Esempio: Camino a lato singolo



Esempio: Caminetto Penisola

2. Una bordatura in metallo DEVE essere installata su tutti i bordi (angoli obliqui). (Non utilizzare elementi di fissaggio lunghi più spessi del materiale del rivestimento delle pareti per evitare di penetrare nell'apparecchio).

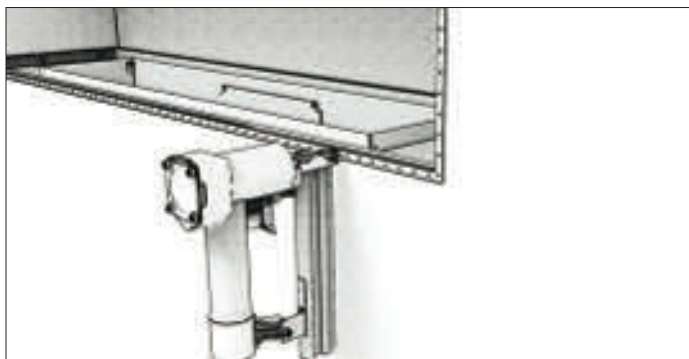

3. Intonare tutte le cuciture e le perline.

Tutti i giunti tra il rivestimento della parete finita e la parte anteriore dell'apparecchio devono essere sigillati con materiali non combustibili. I sigillanti, come mastice o mastice utilizzati per sigillare lo spazio tra la parete e l'apparecchio, devono essere classificati con un'esposizione continua minima a 150°C (122°F).



4. Se la finitura desiderata include una parete verniciata, è possibile utilizzare lattice acrilico al 100% o acrilici a base di olio o standard. Seguire le istruzioni del produttore della vernice per l'applicazione di pittura e primer.

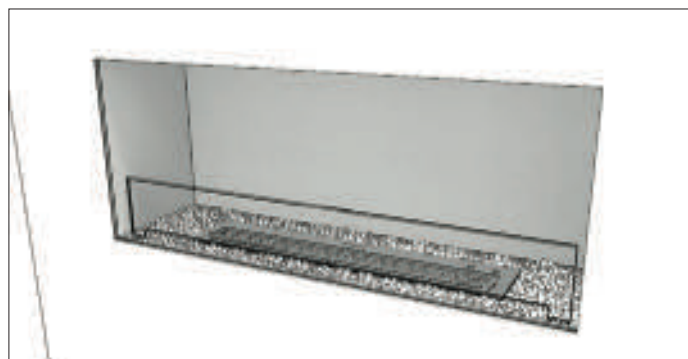

OPERARE SECONDO IL MANUALE OPERATIVO DEL BRUCIATORE INCLUSO CON IL BRUCIATORE.

Bordo del Camino

Piattaforma per Box Decorativa

100

Distanze minime

Se l'impostazione incorpora un mantello, devono essere seguite le dimensioni minime verticali e massime orizzontali del mantello combustibile identificato nell'immagine sottostante.

Spazi di finitura a COMBUSTIBILI

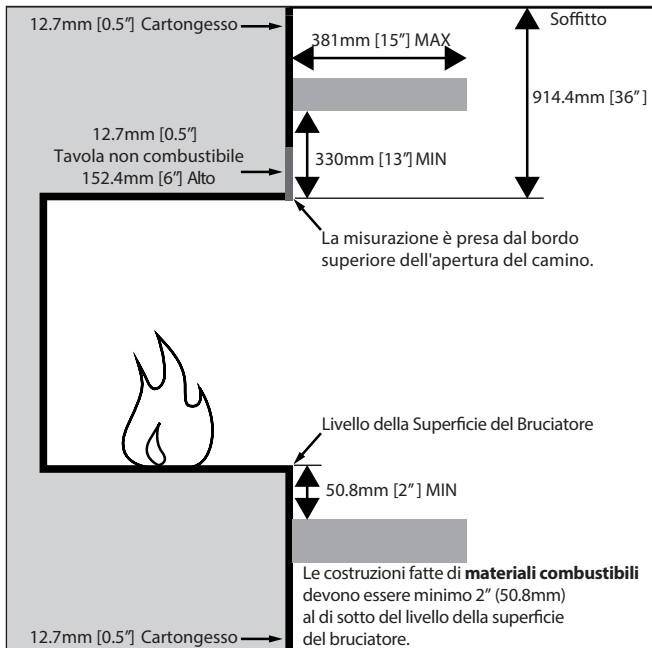

Altezza minima verticale e massima orizzontale del mantello combustibile.

Finiture e spazi liberi a NON COMBUSTIBILI

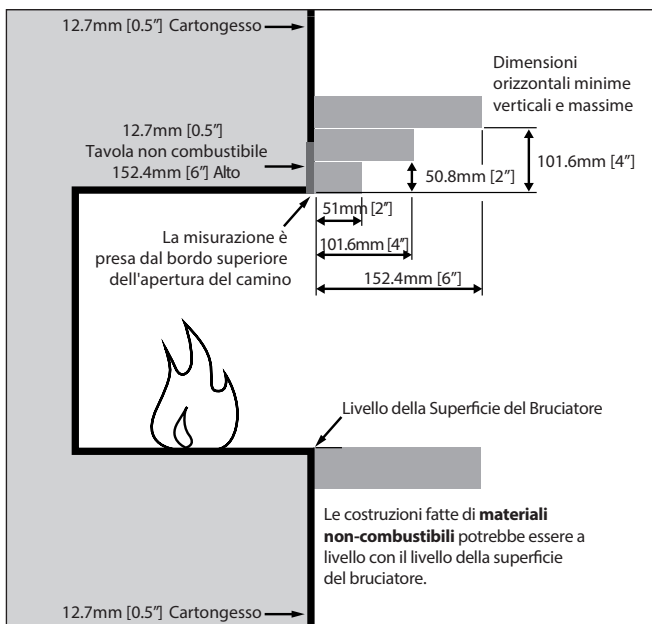

Dimensioni minime verticali e massime orizzontali di mensola non combustibile.

Avvertimento! Rischio di incendio! Rispettare tutte le distanze minime ai combustibili come specificato. Framing o materiale di finitura più vicino del minimo elencato deve essere costruito interamente di materiali non combustibili.

Per gli apparecchi con una scatola laterale decorativa, viene fornita una piastra di riempimento per sollevare il materiale per allinearla con il bordo inferiore dell'apparecchio. Le scatole decorative devono essere utilizzate solo per contenere accessori / materiali non combustibili.

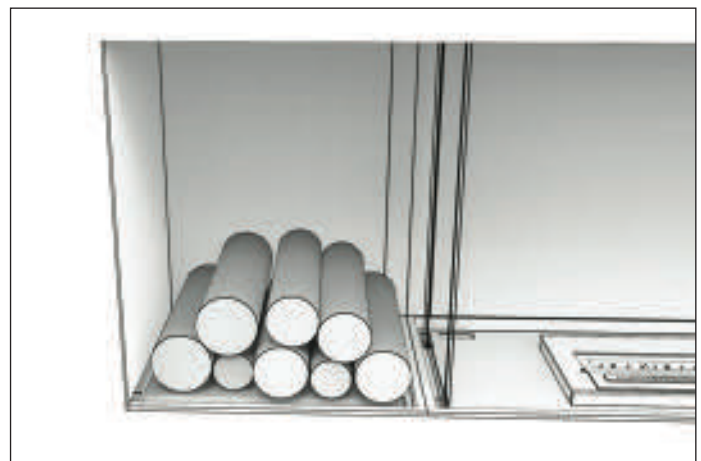
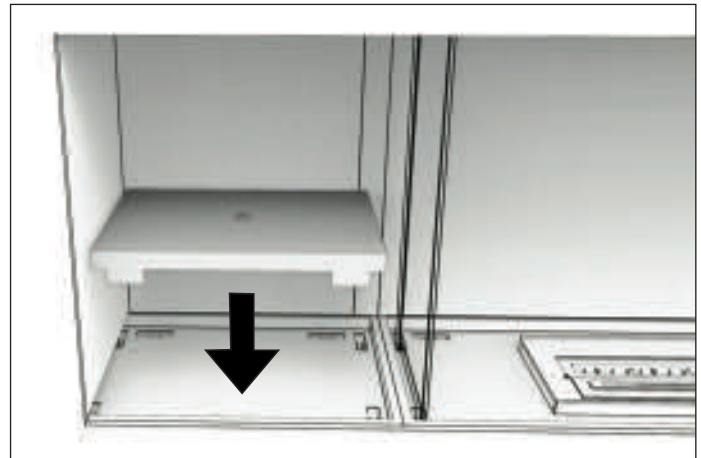

I registri decorativi in acciaio sono disponibili come accessorio opzionale. Si prega di contattare customerservice@ecosmartfire.com

** I ceppi decorativi NON devono essere posti direttamente sopra una fiamma aperta. Sono progettati per sedersi vicino al calore ma non sopra le fiamme.*

Distancias mínimas del inserto

SELECCIÓN DE LA LOCALIZACIÓN DEL APARATO	102
VENTILACION	102
TAMAÑO MÍNIMO DE LA HABITACIÓN	102

Instalación del inserto

ENMARCACIONES	103
ANTES DE EMPEZAR	104
INSTALACIÓN DE UNA CARA	105 - 106
INSTALACIÓN DE ESQUINA IZQUIERDA	107 - 108
INSTALACIÓN DE ESQUINA DERECHA	107 - 108
INSTALACIÓN DE BAHÍA	109 - 110
INSTALACIÓN DE DOBLE CARA	111 - 112
INSTALACIÓN DE PENÍNSULA	113 - 114
INSTALACIÓN DE ISLA	115 - 116
INSTALACIÓN DE BANCO	117 - 118
MATERIALES DE ACABADO	119
MANTOS DE CHIMENEAS	120
PLATO RELLENO DE CAJA DECORATIVA	120

Estos aparatos están aprobados por el fabricante para un uso sólo con los quemadores listados UL incluidos.

OPERACIÓN

Refiérase al manual de operación incluido con el quemador.

Distancias mínimas del inserto

Por favor, lea las instrucciones completamente antes de utilizar el EcoSmart™ Fire.

SELECCIÓN DE LA LOCALIZACIÓN DEL APARATO

La chimenea es prefabricada de espacio libre y puede ser enmarcada con materiales combustibles. Es diseñada solo para alojar los quemadores EcoSmart Fire.

Al seleccionar una ubicación para el aparato, es importante tener en cuenta los tamaños mínimos de la habitación y las distancias necesarias a las paredes y a los materiales combustibles (consulte las imágenes de distancias mínimas y la tabla Tamaño mínimo del cuarto).

Nota: las chimeneas Flex son hechas de acero sellado con zinc cubierto con pintura en polvo de alta temperatura que previene la oxidación. Los quemadores son hechos de acero inoxidable 304. Para garantizar que el (los) quemador (es) siga(n) en buena condición y para evitar la oxidación o corrosión, es importante que cualquier contaminación o residuos se limpien o estén eliminados del quemador inmediatamente.

Si se instala en el exterior, el aparato debe ubicarse debajo de un alero protector para evitar que se llene de agua y estar dañado permanentemente. La garantía se anulará si el producto se daña por instalación en un lugar expuesto.

Cuando no esté en uso, es recomendable que deje la tapa del quemador cerrada para evitar que escombros se caigan en el tanque o que haya contaminación.

PRECAUCIÓN: Riesgo de incendio o quemaduras! Proporcionar espacio adecuado alrededor de las aberturas de aire y para el acceso de servicio. Observe las distancias a los combustibles recomendados en este manual y en el manual del quemador. Asegúrese de que su chimenea esté situada lejos de materiales inflamables u otras fuentes de ignición en todo momento. Debido a las altas temperaturas, la chimenea debe ubicarse fuera del tráfico, de muebles y cortinas. Preste toda la atención al posicionamiento de la chimenea lejos de cosas que puedan moverse como resultado del viento o corrientes. Por ejemplo árboles/ramas/cortinas/papel y similares. Mantenga a los niños a una distancia de seguridad en todo momento y nunca los deje sin supervisión cuando el aparato esté encendido o caliente.

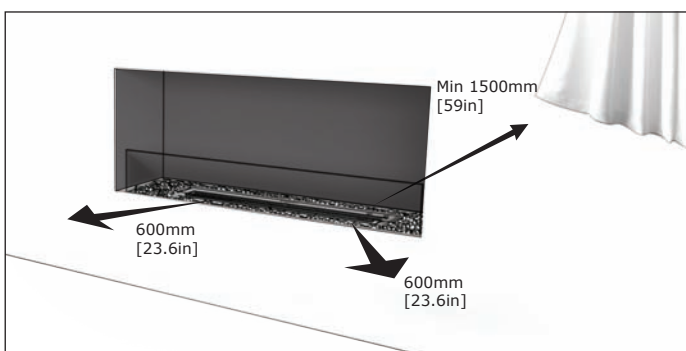

Distancias mínimas en interior

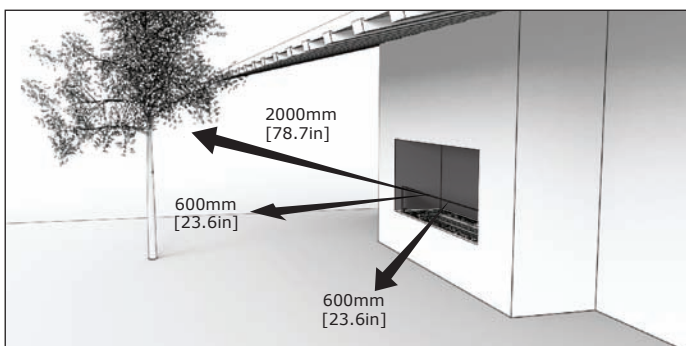

Distancias mínimas en exterior (Necesita un alero o "extensión del techo" sobre la chimenea para asegurarse de que la lluvia no entre en la caja de fuego. Consulte los códigos de construcción locales con respecto a los requisitos para aleros / extensiones de techo)

VENTILACION

Los modelos de ecoSmart fire no requieren ningún tipo de instalación ni elemento permanente, como un tiro para ventilación, una conexión permanente ni ninguna clase de enganche a redes externas para el suministro de combustible.

No cubrir ningún sistema de ventilación o estructuras que sean construidas o instaladas dentro del área de instalación escogida.

Para asegurar una ventilación adecuada, asegúrese de que sigue las indicaciones de la tabla mostrada.

Laboratorios UL calculan el adecuado intercambio de aire como sigue:

en las casas de construcción tradicional, es decir, todas aquellas que no tienen aislamientos especiales, se producen infiltraciones naturales de aire a través de los huecos de la carpintería y mampostería, que aportan el aire suficiente para una buena combustión y ventilación. Sin embargo, si se utiliza el aparato en un espacio pequeño, donde haya menos de 5.7m³ [200ft³] de espacio de aire por cada 1000 BTU de ratio calorífico (con la llama en su nivel máximo) deben abrirse las puertas de paso entre habitaciones, o una rendija 25.4mm [1in] en alguna ventana, para evitar así la posible contaminación ambiental. no deben instalarse chimeneas en cuartos de baño u otros cuartos pequeños.

TAMAÑO MÍNIMO DE LA HABITACIÓN

Tabla de ventilación según el número de quemadores (por aparato).

Modelo	Quemador(es)	Tamaño mínimo de la habitación	BTU
FLEX18	1x AB3	1413 pies cúbicos (40 metros cúbicos)	5,800
FLEX32 FLEX50.BX FLEX68.BX2	1x XL500	2825 pies cúbicos (80 metros cúbicos)	11,430
FLEX42 FLEX60.BX FLEX78.BX2	1x XL700	3178 pies cúbicos (90 metros cúbicos)	13,650
FLEX50 FLEX68.BX FLEX86.BX2	1x XL900	3884 pies cúbicos (110 metros cúbicos)	15,000
FLEX68 FLEX86.BX FLEX104.BX2	1x XL1200	4061 pies cúbicos (115 metros cúbicos)	16,200
FLEX86 FLEX104.BX FLEX122.BX2	2x XL900	7768 pies cúbicos (220 metros cúbicos)	30,000
FLEX104 FLEX122.BX FLEX140.BX2	2x XL1200	8122 pies cúbicos (230 metros cúbicos)	32,400
FLEX122 FLEX140.BX FLEX158.BX2	3x XL900	11652 pies cúbicos (330.2 metros cúbicos)	45,000
FLEX158	3x XL1200	12183 pies cúbicos (345 metros cúbicos)	48,600

NO DISEÑADO PARA UN USO COMO PRINCIPAL FUENTE DE CALOR. Este aparato ha sido probado y aprobado como fuente de calor de habitación adicional o como aparatos decorativos. No debe considerarse como principal fuente de calor en los cálculos de calefacción residencial.

Instalación del inserto

Las chimeneas deben de ser fijadas en posición antes de utilizarlas.

NO INSTALE DIRECTAMENTE CERCA DE PAPEL PINTADO, LAMINADO O CUALQUIERA SUPERFICIE QUE NO ESTÉ CERTIFICADA PARA RESISTIR AL CALOR E ALTAS TEMPERATURAS. EL CALOR PUEDE ESTROPEAR MATERIALES Y AFECTAR LA COLA UTILIZADA EN UNOS CASOS. CUANDO EL QUEMADOR ESTÁ OPERANDO TODA LA ÁREA CERCA DEL MODELO SE CALIENTA. MATERIALES SENSIBLES O QUE REACCIONAN AL CALOR NO DEBERIAN SER USADOS. NO PONGA OBJETOS INFLAMABLES SOBRE O ALREDEDOR DEL QUEMADOR.

Esas parrillas no son diseñadas para incorporar una puerta, tapa o cubierto

La parrilla debe quedarse permanentemente abierta para ventilación. La llama debe de ser en contacto constantemente con aire para funcionar y para que el calor viaje y sea distribuido de manera eficaz.

NO CUBRIR LOS ESPACIOS DE AIREACIÓN REQUERIDOS (EL ESPACIO ENTRE EL ENCASTRE Y EL SEPARADOR) CON AISLANTE U OTROS MATERIALES. LOS ESPACIOS LLENOS DE AIRE SON NECESARIOS PARA UNA ADECUADA VENTILACIÓN DEL QUEMADOR.

No modifique el aparato de ninguna manera durante la instalación. Es prohibido cortar las piezas de chapa del aparato.

La expansión y la contracción de las piezas internas debido al calentamiento y al enfriamiento pueden generar ruido, y esto es normal.

PRECAUCION: NO UTILICE SIN EL CRISTAL PROTECTOR "WINDSCREEN"

Ese accesorio debe de ser instalado antes de su utilización. Retirar o no instalar la pantalla de fuego entrena a una violación de condiciones de garantía y el producto ya no será aprobado.

ENMARCACIONES

Consideraciones importantes para las enmarcaciones

1. La chimenea debe de ser instalada en una superficie nivelada capaz de soportar su peso, el quemador, los guijarros y la capacidad total del combustible.
2. Las enmarcaciones ilustradas en las instrucciones son las dimensiones óptimas que permiten un mejor ajuste con gyprock / sheetrock/ paneles de yeso (u otro material de revestimiento / acabado) después de que se haya instalada la chimenea.
3. Prepare el lugar de instalación. Si coloca la chimenea en una plataforma, constrúyela, asegurándose de acomodar su peso, el quemador, los guijarros y el combustible. Verifique Que la plataforma esté nivelada.

En el caso de que no se pueda soportar el peso de la chimenea, se deben tomar medidas para reforzar el ajuste (por ejemplo, la instalación de una placa para distribuir la carga) de modo que el ajuste sea adecuado para una instalación segura.

IMPORTANTE: El marco sobre la chimenea debe ser autosuficiente. El producto no soporta cargas.

DEFINICIONES

Materiales combustibles: los materiales hechos de o con superficie de madera, papel comprimido, fibras vegetales, plásticos u otro material que pueda inflamarse y quemarse, ya sea producido por la llama o no, o enyesado o sin enlucido se considerarán materiales combustibles.

Materiales no combustibles: materiales que no se encienden ni se queman. Dichos materiales son aquellos que consisten completamente en acero, hierro, ladrillo, azulejo, concreto, pizarra, vidrio o revestimientos, o cualquier combinación de los mismos. HardieBacker®, WonderBoard®, Durock® o materiales cuyo cumplimiento con ASTM E 136, Método de prueba estándar para el comportamiento del material en un horno de tubo vertical a 750 ° C, se considerarán materiales no combustibles .

NOTA: Las ilustraciones representan instalaciones típicas y están destinadas únicamente para fines de diseño. Las ilustraciones / diagramas no están dibujados a escala completa. La instalación real puede variar según las preferencias de diseño individuales.

Instalación del inserto

ANTES DE EMPEZAR

1. Retire con cuidado la chimenea de los componentes del paquete.
2. Inspecciona e informe las piezas dañadas durante el transporte, especialmente el estado del vidrio protector.
3. Lea todas las instrucciones antes de comenzar la instalación. Siga estas precauciones cuidadosamente durante la instalación para garantizar su seguridad y la de quienes le rodean.

PRECAUCIÓN: ¡Peligro de incendio o explosión! Las piezas dañadas pueden comprometer el funcionamiento adecuado. No instale piezas dañadas, incompletas o reemplace con otras partes.

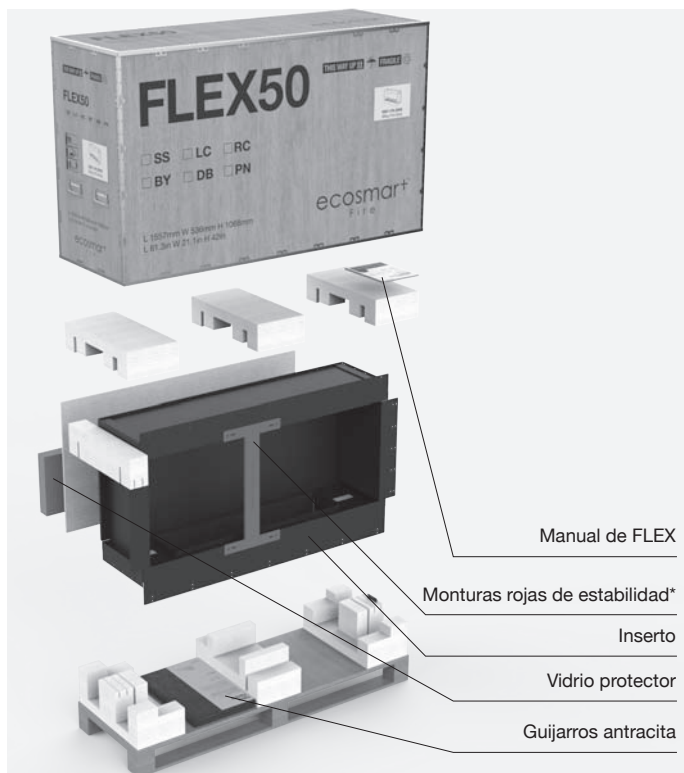

Caja del inserto

* No aplicable a los modelos Flex de banco.

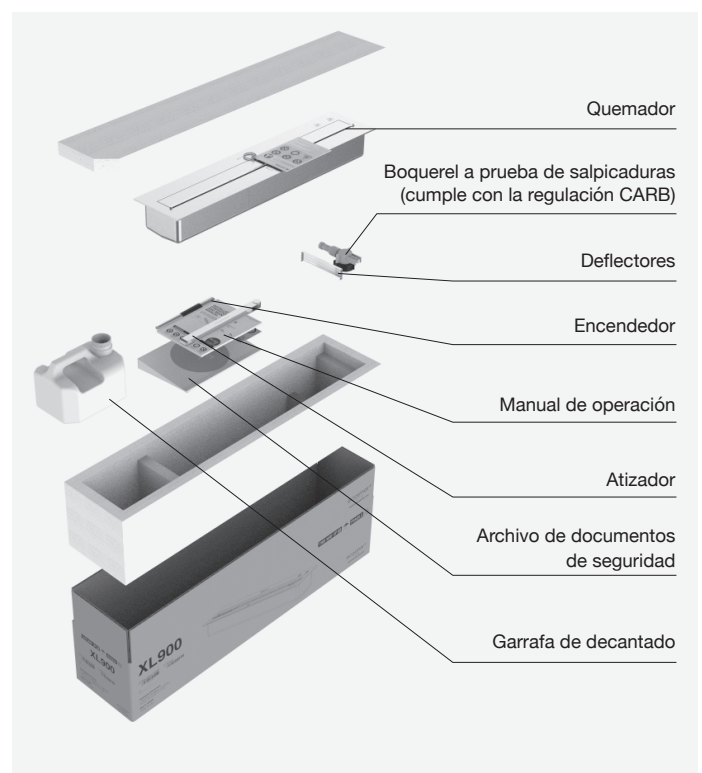

Caja del quemador

Instalación de una cara

Equipo requerido: taladro eléctrico, destornillador, nivel, llana de mano para yeso, pistola de silicona, pistola de calafatear.

1. Construya el marco de la pared principal con las enmarcaciones ilustradas en la Tabla A. La base del marco puede ser un banco / plataforma sólida, que ayudará a nivelar el inserto cuando esté en posición.



Tabla A: Enmarcaciones

Las dimensiones del modelo real deben compararse con las dimensiones del corte ANTES de la instalación final para confirmar una alineación perfecta.

INSERTO	AN mm [in]	F mm [in]	A mm [in]	Peso* kg [lbs]
FLEX18SS	488 [19.2]	365 [14.4]	730 [28.7]	25.7 [56.5]
FLEX32SS	922 [36.3]	365 [14.4]	730 [28.7]	45.7 [100.5]
FLEX42SS	1177 [46.3]	365 [14.4]	730 [28.7]	60 [131.9]
FLEX50SS	1380 [54.3]	365 [14.4]	730 [28.7]	71.4 [157.1]
FLEX50SS.BX	1380 [54.3]	365 [14.4]	730 [28.7]	69.9 [153.8]
FLEX60SS.BX	1634 [64.3]	365 [14.4]	730 [28.7]	83.9 [184.6]
FLEX68SS	1840 [72.4]	365 [14.4]	730 [28.7]	97.1 [213.6]
FLEX68SS.BX	1840 [72.4]	365 [14.4]	730 [28.7]	95.1 [209.2]
FLEX68SS.BX2	1840 [72.4]	365 [14.4]	730 [28.7]	93.9 [206.7]
FLEX78SS.BX2	2090 [82.3]	365 [14.4]	730 [28.7]	107.8 [237.1]
FLEX86SS	2300 [90.5]	365 [14.4]	730 [28.7]	121.5 [267.3]
FLEX86SS.BX	2300 [90.5]	365 [14.4]	730 [28.7]	119.4 [262.7]
FLEX86SS.BX2	2300 [90.5]	365 [14.4]	730 [28.7]	118.8 [261.4]
FLEX104SS	2760 [108.7]	365 [14.4]	730 [28.7]	146.2 [321.6]
FLEX104SS.BX	2760 [108.7]	365 [14.4]	730 [28.7]	145.2 [319.4]
FLEX104SS.BX2	2760 [108.7]	365 [14.4]	730 [28.7]	193.8 [426.4]
FLEX122SS	3220 [126.7]	365 [14.4]	730 [28.7]	171.5 [377.3]
FLEX122SS.BX	3220 [126.7]	365 [14.4]	730 [28.7]	170.1 [374.2]
FLEX122SS.BX2	3220 [126.7]	365 [14.4]	730 [28.7]	168.9 [371.6]
FLEX140SS.BX	3680 [144.9]	365 [14.4]	730 [28.7]	195.2 [429.4]
FLEX140SS.BX2	3680 [144.9]	365 [14.4]	730 [28.7]	193.8 [426.4]
FLEX158SS	4140 [163]	365 [14.4]	730 [28.7]	222.1 [488.6]
FLEX158SS.BX2	4140 [163]	365 [14.4]	730 [28.7]	218.9 [481.6]

* El peso del inserto incluye el / los quemador(es) (peso seco sin combustible), guijarros y vidrio. NO incluyen los guijarros antracita para las cajas decorativas laterales.

IMPORTANTE: El marco sobre la chimenea debe ser autosuficiente. El producto no soporta cargas.

2. Deslice el inserto dentro de la cavidad del marco (la base del dispositivo se puede sentar directamente sobre el material de marco 2 x 4). El inserto está mandado con soportes de estabilidad rojos instalados en el (los) lado (s) abierto (s) para mantener el cuadrado del inserto durante el transporte y durante la instalación. Mantenga el (los) soporte (s) mientras enmarca la configuración para ayudar a minimizar el movimiento de la chimenea.

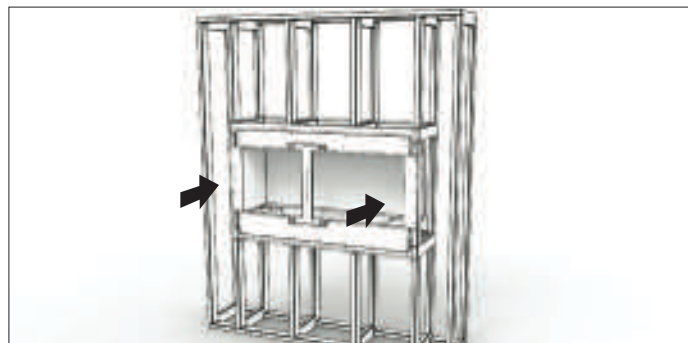

3. Fije el inserto al marco con tornillos utilizando los orificios de montaje existentes en sus bridas. Asegúrese de que el inserto esté nivelado antes de instalarlo en su lugar.



4. Retire los soportes de estabilidad rojos.

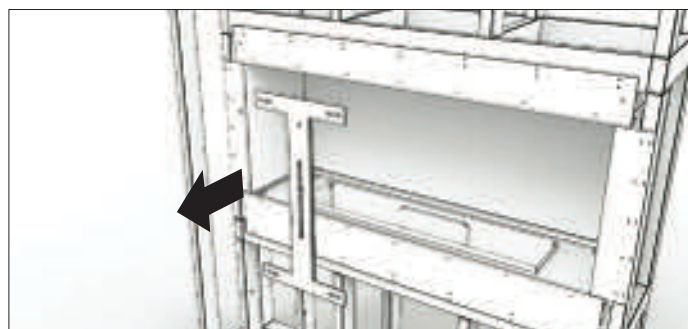

Instalación de una cara

5. Complete la construcción terminando con los paneles de pared alrededor del inserto. (Consulte la sección sobre **INSTRUCCIONES DE MATERIALES DE ACABADO** y asegúrese de que entienda perfectamente dónde se deben usar materiales no combustibles).

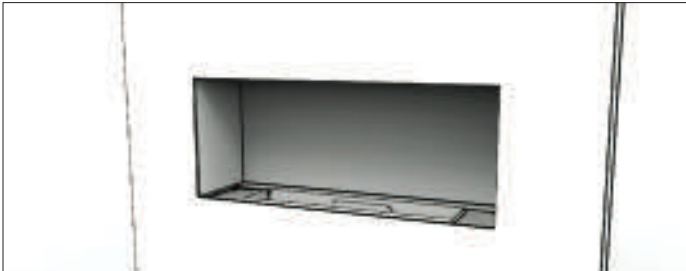

6. Coloque el quemador en posición.

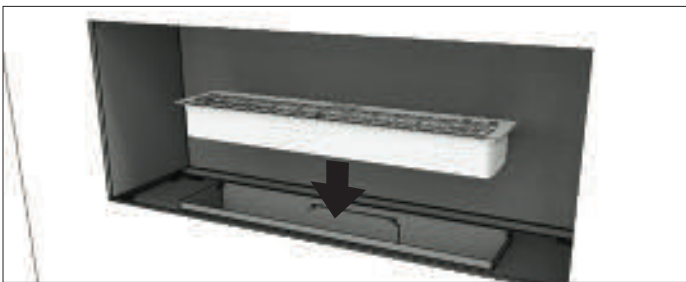

7. Retire la cinta protectora que cubre las ranuras de montaje del vidrio protector.

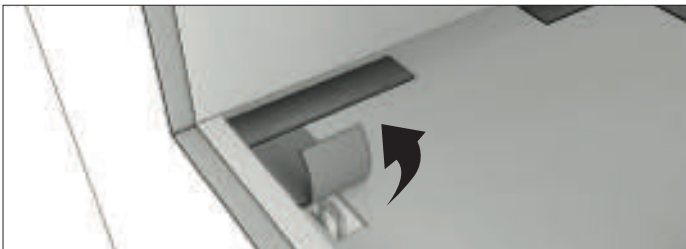

8. Si su inserto incluye una caja decorativa a la izquierda / derecha o ambas, inserte el / los panel (es) de vidrio interno (s) introduciendo el vidrio hacia arriba en la ranura y luego empujando hacia abajo en los clips colocados.

** Los troncos decorativos NO se deben colocar directamente sobre una llama abierta. Están diseñados para sentarse cerca del calor, pero no encima de las llamas.*

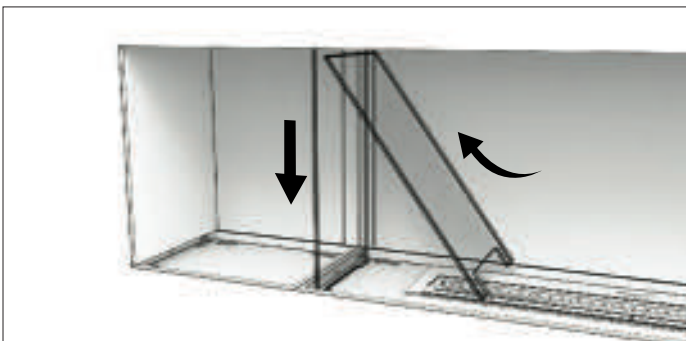

9. Instale el vidrio protector insertando los dos extremos en las ranuras apropiadas del inserto. Use una pequeña cantidad de presión para empujar el vidrio protector en su lugar hasta que toque el fondo de los clips de vidrio ocultos.

ADVERTENCIA: el vidrio utilizado es vidrio templado, significa que es más resistente que el vidrio normal. Es importante destacar que, a pesar de que es más resistente, el vidrio templado aún tiene debilidades. Las esquinas y los lados son puntos de presión específicos donde es más frágil y pueden romperse si no se tiene cuidado. El vidrio se rompe en muchos pedazos pequeños. Tenga cuidado de evitar los cortes. Le recomendamos usar guantes protectores cuando manipule vidrio.



10. Extienda los guijarros antracita de manera uniforme alrededor de la bandeja del aparato. **PRECAUCIÓN:** Asegúrese de que la tapa del quemador esté cerrada. Mantenga los guijarros antracita alejado de la brida del quemador para evitar que se introduzcan accidentalmente en el tanque del quemador. Tenga cuidado de no rayar el quemador.

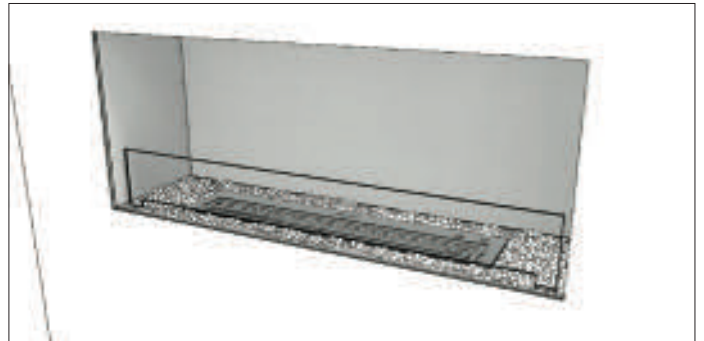

Instalación de Esquina izquierda & Esquina derecha

Equipo requerido: taladro eléctrico, destornillador, nivel, llana de mano para yeso, pistola de silicona, pistola de calafatear.

1. Construya el marco de la pared principal con las enmarcaciones ilustradas en la Tabla B. La base del marco puede ser un banco / plataforma sólida, que ayudará a nivelar el inserto cuando esté en posición.
NOTA: Las ilustraciones son de instalación de esquina izquierda.



Tabla B: Enmarcaciones

Las dimensiones del modelo real deben compararse con las dimensiones del corte ANTES de la instalación final para confirmar una alineación perfecta.

INSERTO (LC & RC)	AN mm [in]	F mm [in]	A mm [in]	Peso* kg [lbs]
FLEX18LC	470 [18.5]	365 [14.4]	730 [28.7]	33 [72.6]
FLEX32LC	902 [35.5]	365 [14.4]	730 [28.7]	48.8 [107.4]
FLEX42LC	1157 [45.5]	365 [14.4]	730 [28.7]	63.3 [139.3]
FLEX50LC	1362 [53.6]	365 [14.4]	730 [28.7]	71.6k [157.5]
FLEX50LC.BX	1362 [53.6]	365 [14.4]	730 [28.7]	73.1 [160.8]
FLEX60LC.BX	1617 [63.7]	365 [14.4]	730 [28.7]	87.1 [191.6]
FLEX68LC	1822 [71.7]	365 [14.4]	730 [28.7]	100.3 [220.7]
FLEX68LC.BX	1822 [71.7]	365 [14.4]	730 [28.7]	95.3 [209.7]
FLEX68LC.BX2	1822 [71.7]	365 [14.4]	730 [28.7]	97kg [213.4]
FLEX78LC.BX2	2077 [81.8]	365 [14.4]	730 [28.7]	111 [244.2]
FLEX86LC	2282 [89.8]	365 [14.4]	730 [28.7]	121.7 [267.7]
FLEX86LC.BX	2282 [89.8]	365 [14.4]	730 [28.7]	122.6 [269.7]
FLEX86LC.BX2	2282 [89.8]	365 [14.4]	730 [28.7]	119 [261.8]
FLEX104LC	2742 [107.9]	365 [14.4]	730 [28.7]	149.5 [328.9]
FLEX104LC.BX	2742 [107.9]	365 [14.4]	730 [28.7]	145.4 [319.9]
FLEX104LC.BX2	2742 [107.9]	365 [14.4]	730 [28.7]	146.9 [323.2]
FLEX122LC	3202 [126.1]	365 [14.4]	730 [28.7]	171.7 [377.7]
FLEX122LC.BX	3202 [126.1]	365 [14.4]	730 [28.7]	173.4 [381.5]
FLEX122LC.BX2	3202 [126.1]	365 [14.4]	730 [28.7]	169.1 [372]
FLEX140LC.BX	3662 [144.2]	365 [14.4]	730 [28.7]	197.1 [433.6]
FLEX140LC.BX2	3662 [144.2]	365 [14.4]	730 [28.7]	195.4 [429.9]
FLEX158LC	4122 [162.3]	365 [14.4]	730 [28.7]	225.5 [496.1]
FLEX158LC.BX2	4122 [162.3]	365 [14.4]	730 [28.7]	219.1 [482]

* El peso del inserto incluye el / los quemador(es) (peso seco sin combustible), guijarros y vidrio. NO incluyen los guijarros antracita para las cajas decorativas laterales.

IMPORTANTE: El marco sobre la chimenea debe ser autosuficiente. El producto no soporta cargas.

2. Deslice el inserto dentro de la cavidad del marco (la base del dispositivo se puede sentar directamente sobre el material de marco 2 x 4). El inserto está mandado con soportes de estabilidad rojos instalados en el (los) lado (s) abierto (s) para mantener el cuadrado del inserto durante el transporte y durante la instalación. Mantenga el (los) soporte (s) mientras enmarca la configuración para ayudar a minimizar el movimiento de la chimenea. Alinee el panel de extensión de la brida de la esquina superior con los orificios roscados en el estante superior y atornille en su lugar con los tornillos incluidos.

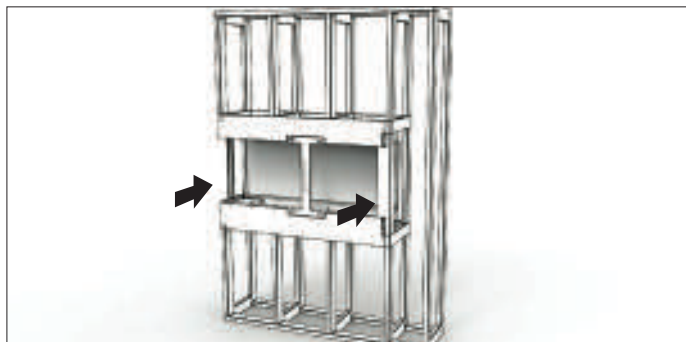

3. Fije el inserto al marco con tornillos utilizando los orificios de montaje existentes en sus bridas. Asegúrese de que el inserto esté nivelado antes de instalarlo en su lugar.

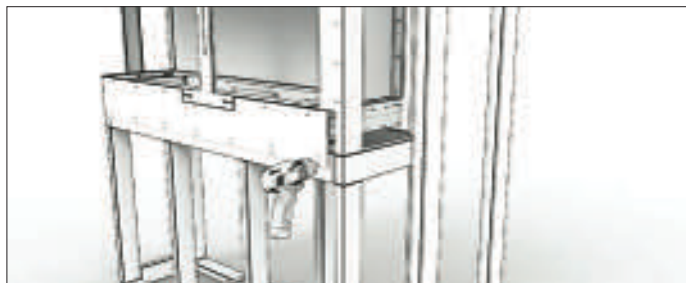

4. Retire los soportes de estabilidad rojos.

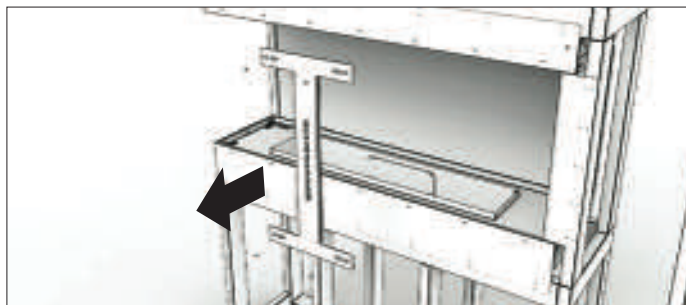

Instalación de Esquina izquierda & Esquina derecha

5. Complete la construcción terminando con los paneles de pared alrededor del inserto. (Consulte la sección sobre **INSTRUCCIONES DE MATERIALES DE ACABADO** y asegúrese de que entienda perfectamente dónde se deben usar materiales no combustibles).



6. Coloque el quemador en posición.

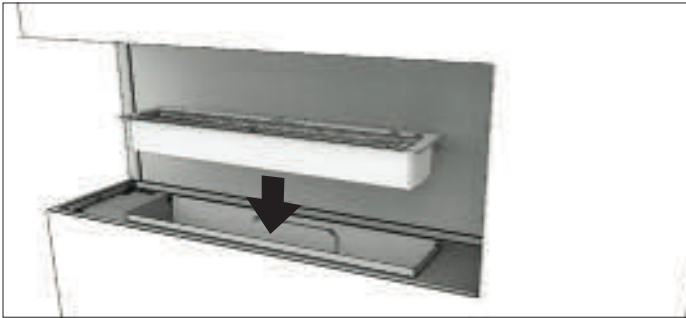

7. Retire la cinta protectora que cubre las ranuras de montaje del vidrio protector.

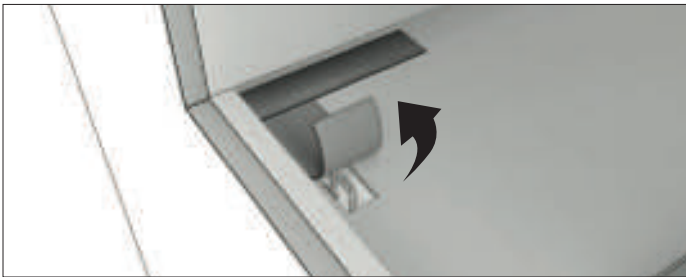

8. Si su inserto incluye una caja decorativa a la izquierda / derecha o ambas, inserte el / los panel (es) de vidrio interno (s) introduciendo el vidrio hacia arriba en la ranura y luego empujando hacia abajo en los clips colocados.

** Los troncos decorativos NO se deben colocar directamente sobre una llama abierta. Están diseñados para sentarse cerca del calor, pero no encima de las llamas.*

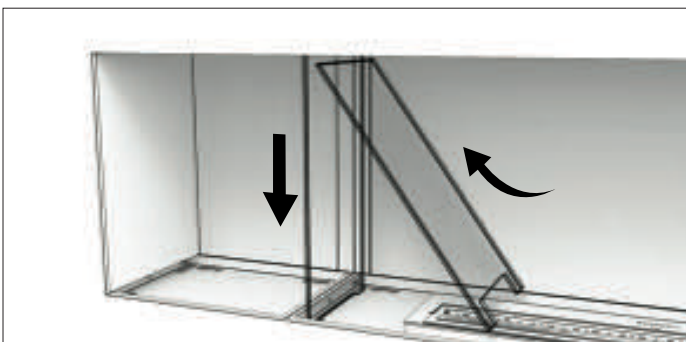

9. Inserte el panel de vidrio de altura completa en uno de los lados del extremo abierto insertando el vidrio en la abertura en la parte superior del inserto, y bajándolo en las ranuras de la base hasta que toque fondo.



10. Instale el vidrio protector insertando los dos extremos en las ranuras apropiadas del inserto. Use una pequeña cantidad de presión para empujar el vidrio protector en su lugar hasta que toque el fondo de los clips de vidrio ocultos.

ADVERTENCIA: el vidrio utilizado es vidrio templado, significa que es más resistente que el vidrio normal. Es importante destacar que, a pesar de que es más resistente, el vidrio templado aún tiene debilidades. Las esquinas y los lados son puntos de presión específicos donde es más frágil y pueden romperse si no se tiene cuidado. El vidrio se rompe en muchos pedazos pequeños. Tenga cuidado de evitar los cortes. Le recomendamos usar guantes protectores cuando manipule vidrio.

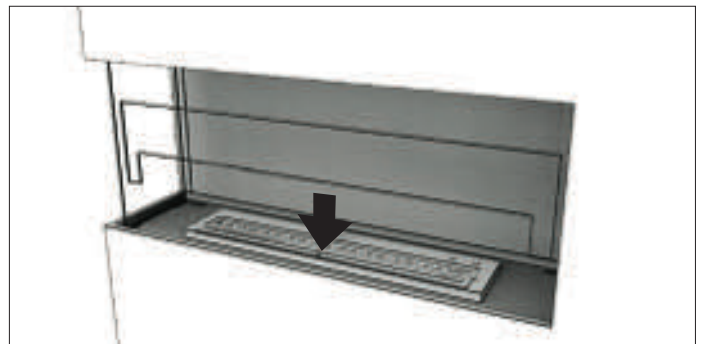

11. Extienda los guijarros antracita de manera uniforme alrededor de la bandeja del aparato. **PRECAUCIÓN:** Asegúrese de que la tapa del quemador esté cerrada. Mantenga los guijarros antracita alejado de la brida del quemador para evitar que se introduzcan accidentalmente en el tanque del quemador. Tenga cuidado de no rayar el quemador.

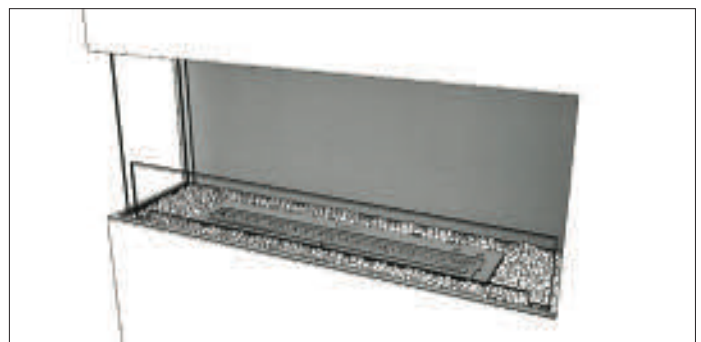

Instalación de bahía

Equipo requerido: taladro eléctrico, destornillador, nivel, llana de mano para yeso, pistola de silicona, pistola de calafatear.

1. Construya el marco de la pared principal con las enmarcaciones ilustradas en la Tabla C. La base del marco puede ser un banco / plataforma sólida, que ayudará a nivelar el inserto cuando esté en posición.



Tabla C: Enmarcaciones

Las dimensiones del modelo real deben compararse con las dimensiones del corte ANTES de la instalación final para confirmar una alineación perfecta.

INSERTO	AN mm [in]	F mm [in]	A mm [in]	Peso* kg [lbs]
FLEX18BY	460 [18.1]	365 [14.4]	730 [28.7]	40.7 [89.5]
FLEX32BY	892 [35.1]	365 [14.4]	730 [28.7]	51.9 [114.2]
FLEX42BY	1147 [45.2]	365 [14.4]	730 [28.7]	66.5 [146.3]
FLEX50BY	1352 [53.2]	365 [14.4]	730 [28.7]	71.8 [158]
FLEX50BY.BX	1353 [53.3]	365 [14.4]	730 [28.7]	76.2 [167.6]
FLEX60BY.BX	1608 [63.3]	365 [14.4]	730 [28.7]	90.3 [198.7]
FLEX68BY	1813 [71.4]	365 [14.4]	730 [28.7]	103.6 [227.9]
FLEX68BY.BX	1813 [71.4]	365 [14.4]	730 [28.7]	95.5 [210.1]
FLEX68BY.BX2	1813 [71.4]	365 [14.4]	730 [28.7]	100.2 [220.4]
FLEX78BY.BX2	2068 [81.4]	365 [14.4]	730 [28.7]	114 [250.8]
FLEX86BY	2272 [89.4]	365 [14.4]	730 [28.7]	121.9 [268.2]
FLEX86BY.BX	2272 [89.4]	365 [14.4]	730 [28.7]	125.9 [277]
FLEX86BY.BX2	2272 [89.4]	365 [14.4]	730 [28.7]	119.2 [262.2]
FLEX104BY	2733 [107.6]	365 [14.4]	730 [28.7]	152.9 [336.4]
FLEX104BY.BX	2733 [107.6]	365 [14.4]	730 [28.7]	145.6 [320.3]
FLEX104BY.BX2	2733 [107.6]	365 [14.4]	730 [28.7]	150.1 [330.2]
FLEX122BY	3193 [125.7]	365 [14.4]	730 [28.7]	171.9 [378.2]
FLEX122BY.BX	3193 [125.7]	365 [14.4]	730 [28.7]	176.7 [388.7]
FLEX122BY.BX2	3193 [125.7]	365 [14.4]	730 [28.7]	169.3 [372.5]
FLEX140BY.BX	3653 [143.8]	365 [14.4]	730 [28.7]	195.6 [430.3]
FLEX140BY.BX2	3653 [143.8]	365 [14.4]	730 [28.7]	200.3 [440.7]
FLEX158BY	4113 [161.9]	365 [14.4]	730 [28.7]	228.8 [503.4]
FLEX158BY.BX2	4113 [161.9]	365 [14.4]	730 [28.7]	219.3 [482.5]

* El peso del inserto incluye el / los quemador(es) (peso seco sin combustible), guijarros y vidrio. NO incluyen los guijarros antracita para las cajas decorativas laterales.

IMPORTANTE: El marco sobre la chimenea debe ser autosuficiente. El producto no soporta cargas.

2. Deslice el inserto dentro de la cavidad del marco (la base del dispositivo se puede sentar directamente sobre el material de marco 2 x 4). El inserto está mandado con soportes de estabilidad rojos instalados en el (los) lado (s) abierto (s) para mantener el cuadrado del inserto durante el transporte y durante la instalación. Mantenga el (los) soporte (s) mientras enmarca la configuración para ayudar a minimizar el movimiento de la chimenea.

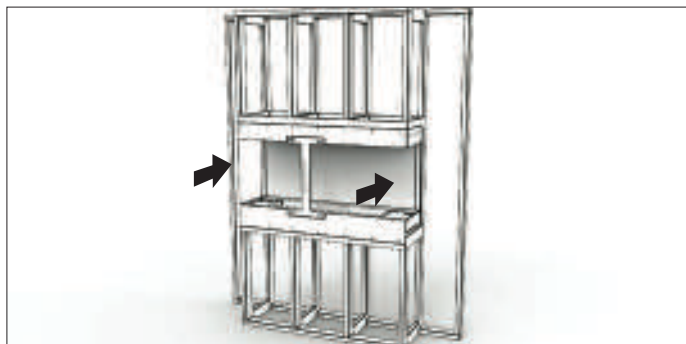

3. Asegúrese de que los bordes laterales izquierdo y derecho del inserto estén nivelados con los pernos de la estructura.

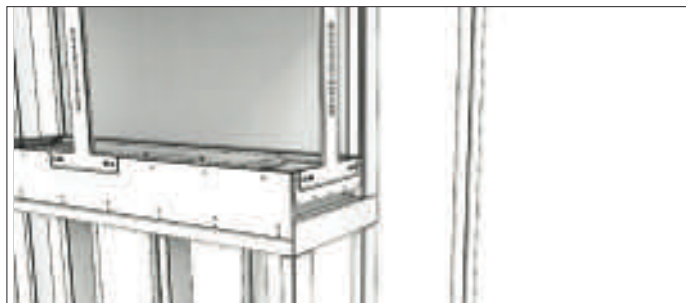

4. Fije el inserto al marco con tornillos utilizando los orificios de montaje existentes en sus bridas. Asegúrese de que el inserto esté nivelado antes de instalarlo en su lugar.

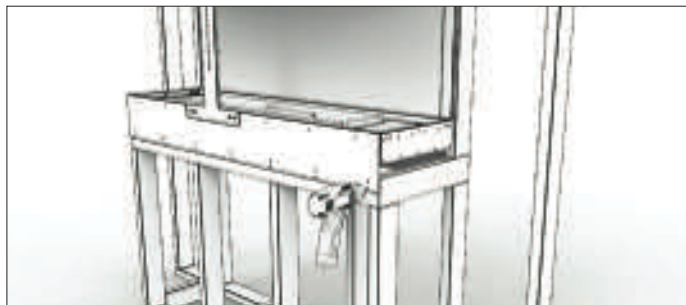

5. Retire los soportes de estabilidad rojos.

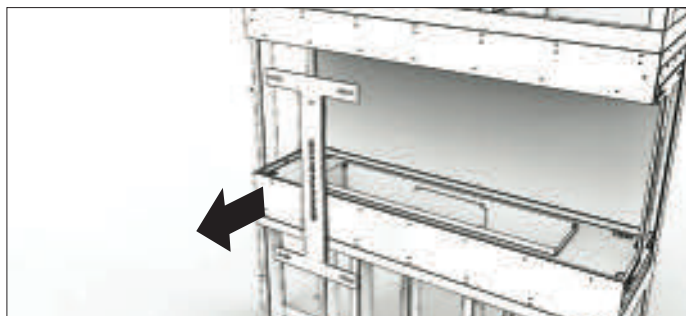

Instalación de bahía

6. Complete la construcción terminando con los paneles de pared alrededor del inserto. (Consulte la sección sobre **INSTRUCCIONES DE MATERIALES DE ACABADO** y asegúrese de que entienda perfectamente dónde se deben usar materiales no combustibles).

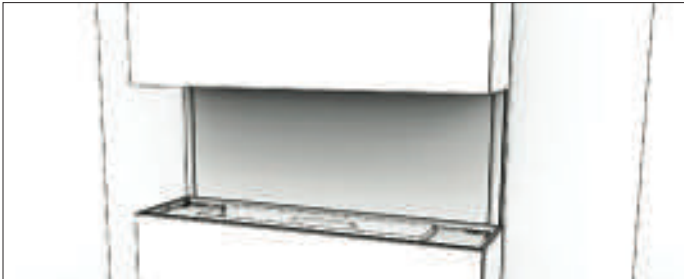

7. Coloque el quemador en posición.

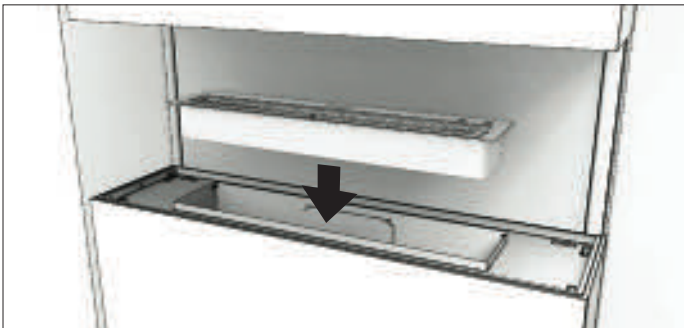

8. Retire la cinta protectora que cubre las ranuras de montaje del vidrio protector.



9. Si su inserto incluye una caja decorativa a la izquierda / derecha o ambas, inserte el / los panel (es) de vidrio interno (s) introduciendo el vidrio hacia arriba en la ranura y luego empujando hacia abajo en los clips colocados.

* Los troncos decorativos **NO** se deben colocar directamente sobre una llama abierta. Están diseñados para sentarse cerca del calor, pero no encima de las llamas.

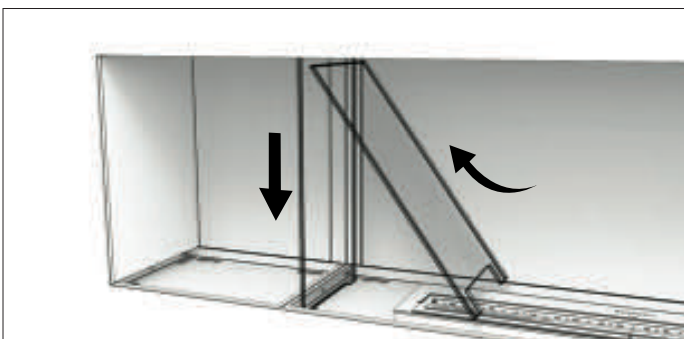

10. Inserte el panel de vidrio de altura completa en uno de los lados del extremo abierto insertando el vidrio en la abertura en la parte superior del aparato, y bajándolo en las ranuras de la base hasta que se asiente en su lugar. Repita lo mismo para el otro lado del aparato.

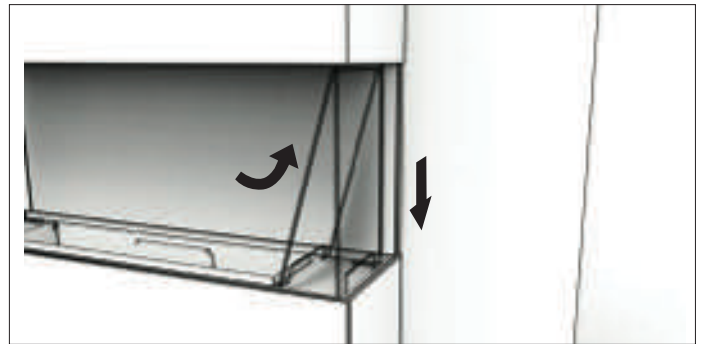

11. Instale el vidrio protector insertando los dos extremos en las ranuras apropiadas del inserto. Use una pequeña cantidad de presión para empujar el vidrio protector en su lugar hasta que toque el fondo de los clips de vidrio ocultos.

ADVERTENCIA: el vidrio utilizado es vidrio templado, significa que es más resistente que el vidrio normal. Es importante destacar que, a pesar de que es más resistente, el vidrio templado aún tiene debilidades. Las esquinas y los lados son puntos de presión específicos donde es más frágil y pueden romperse si no se tiene cuidado. El vidrio se rompe en muchos pedazos pequeños. Tenga cuidado de evitar los cortes. Le recomendamos usar guantes protectores cuando manipule vidrio.

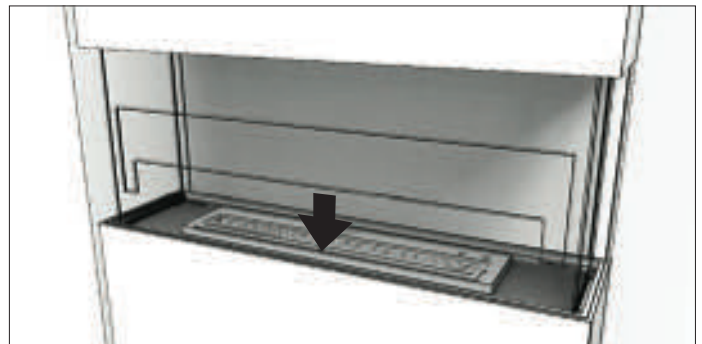

12. Extienda los guijarros antracita de manera uniforme alrededor de la bandeja del aparato. **PRECAUCIÓN:** Asegúrese de que la tapa del quemador esté cerrada. Mantenga los guijarros antracita alejado de la brida del quemador para evitar que se introduzcan accidentalmente en el tanque del quemador. Tenga cuidado de no rayar el quemador.

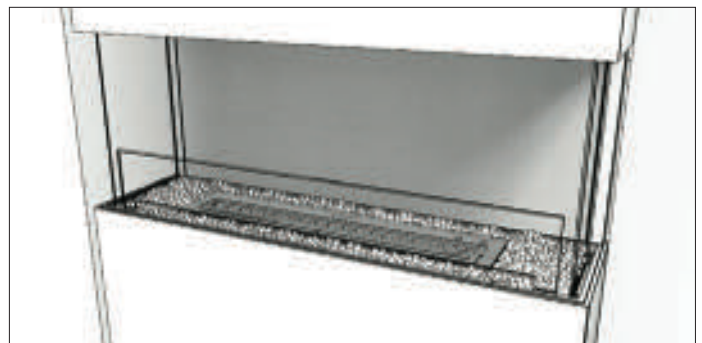

Instalación de doble cara

Equipo requerido: taladro eléctrico, destornillador, nivel, llana de mano para yeso, pistola de silicona, pistola de calafatear.

1. Construya el marco de la pared principal con las enmarcaciones ilustradas en la Tabla D. La base del marco puede ser un banco / plataforma sólida, que ayudará a nivelar el inserto cuando esté en posición.

Advertencia: los insertos de doble cara no pueden instalarse en una pared de cavidad unidireccional, debe ser una cavidad bidireccional donde el vidrio de ambos lados esté libre de obstrucciones. No aplique presión ni materiales sobre el vidrio. Los insertos de doble cara están diseñados como inserciones divisorias de pared. Si no cumple con estas instrucciones de instalación, la pared podría sobrecalentarse y incendiarse.



Tabla D: Enmarcaciones

Las dimensiones del modelo real deben compararse con las dimensiones del corte ANTES de la instalación final para confirmar una alineación perfecta.

INSERTO	AN mm [in]	F mm [in]	A mm [in]	Peso* kg [lbs]
FLEX18DB	488 [19.2]	349 [13.6]	730 [28.7]	26.5 [58.3]
FLEX32DB	922 [36.3]	349 [13.6]	730 [28.7]	46.6 [102.5]
FLEX42DB	1177 [46.3]	349 [13.6]	730 [28.7]	61.4 [135.1]
FLEX50DB	1380 [54.3]	349 [13.6]	730 [28.7]	70.8 [155.8]
FLEX50DB.BX	1380 [54.3]	349 [13.6]	730 [28.7]	70 [154]
FLEX60DB.BX	1634 [64.3]	349 [13.6]	730 [28.7]	83.3 [183.3]
FLEX68DB	1840 [72.4]	349 [13.6]	730 [28.7]	95.5 [210.1]
FLEX68DB.BX	1840 [72.4]	349 [13.6]	730 [28.7]	83.7 [184.1]
FLEX68DB.BX2	1840 [72.4]	349 [13.6]	730 [28.7]	94.8 [208.6]
FLEX78DB.BX2	2090 [82.3]	349 [13.6]	730 [28.7]	106.2 [233.6]
FLEX86DB	2300 [90.5]	349 [13.6]	730 [28.7]	102.3 [225.1]
FLEX86DB.BX	2300 [90.5]	349 [13.6]	730 [28.7]	124.5 [273.9]
FLEX86DB.BX2	2300 [90.5]	349 [13.6]	730 [28.7]	108.5 [238.7]
FLEX104DB	2760 [108.7]	349 [13.6]	730 [28.7]	145.7 [320.5]
FLEX104DB.BX	2760 [108.7]	349 [13.6]	730 [28.7]	127.1 [279.6]
FLEX104DB.BX2	2760 [108.7]	349 [13.6]	730 [28.7]	142 [312]
FLEX122DB	3220 [126.7]	349 [13.6]	730 [28.7]	145.6 [320.3]
FLEX122DB.BX	3220 [126.7]	349 [13.6]	730 [28.7]	170.1 [374.2]
FLEX122DB.BX2	3220 [126.7]	349 [13.6]	730 [28.7]	151.9 [334.2]
FLEX140DB.BX	3680 [144.9]	349 [13.6]	730 [28.7]	170.4 [374.9]
FLEX140DB.BX2	3680 [144.9]	349 [13.6]	730 [28.7]	192.9 [424.4]
FLEX158DB	4140 [163]	349 [13.6]	730 [28.7]	226.8 [499]
FLEX158DB.BX2	4140 [163]	349 [13.6]	730 [28.7]	195.2 [429.4]

* El peso del inserto incluye el / los quemador(es) (peso seco sin combustible), guijarros y vidrio. NO incluyen los guijarros antracita para las cajas decorativas laterales.

IMPORTANTE: El marco sobre la chimenea debe ser autosuficiente. El producto no soporta cargas.

2. Retire la brida de extensión de la chimenea para que ambos lados tengan la misma altura. Esto ayudará a facilitar el deslizamiento de la chimenea en el marco. Preste atención para no perder los tornillos, ya que serán necesarios cuando se vuelva a instalar la brida.

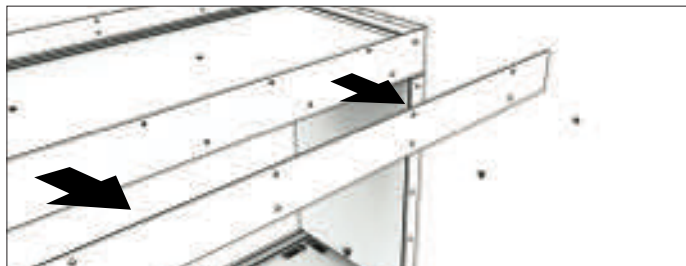

3. Deslice el inserto dentro de la cavidad del marco (La bandeja inferior se puede sentar directamente en la parte superior del marco). El inserto está mandado con soportes de estabilidad rojos instalados en el (los) lado (s) abierto (s) para mantener el cuadrado del inserto durante el transporte y durante la instalación. Mantenga el (los) soporte (s) mientras enmarca la configuración para ayudar a minimizar el movimiento de la chimenea.

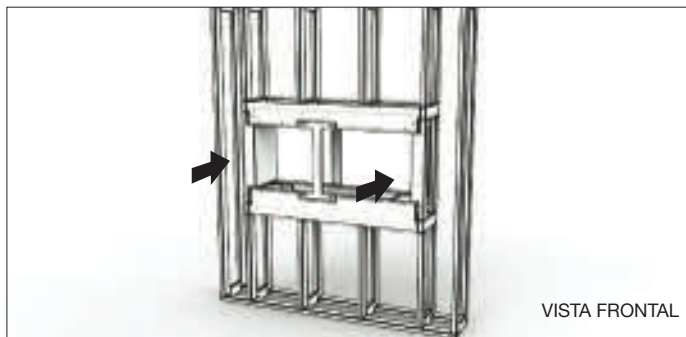

4. Alinee el panel de extensión de la brida con los orificios roscados del aparato. Atorníllelo en su lugar con los tornillos incluidos (fila inferior en el inserto, fila superior en el material de la estructura) para fijarlo en su posición.

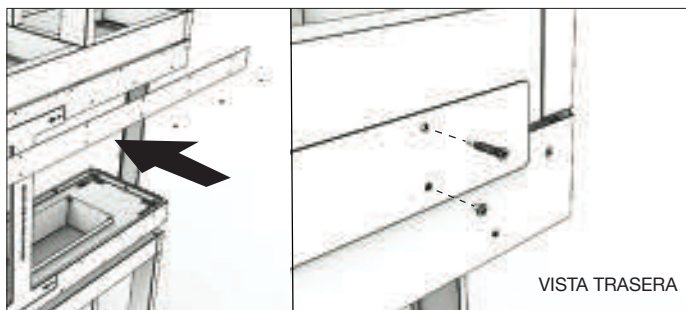

5. Fije el inserto al marco con tornillos utilizando los orificios de montaje existentes en sus bridas. Asegúrese de que el inserto esté nivelado antes de instalarlo en su lugar.



Instalación de doble cara

6. Retire los soportes de estabilidad rojos.

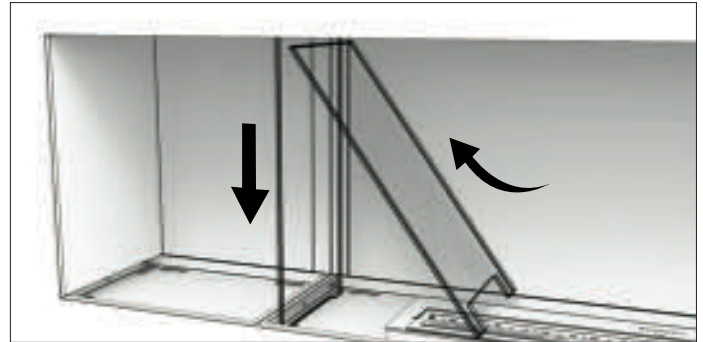
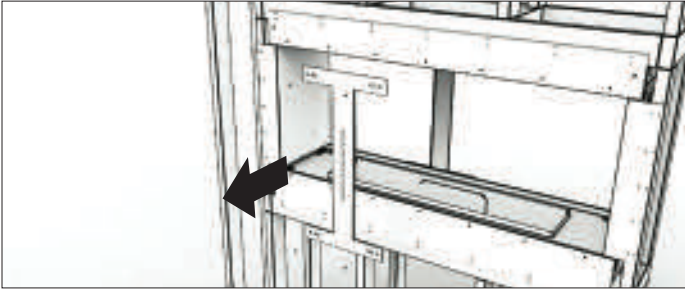

7. Complete la construcción terminando con los paneles de pared alrededor del inserto. (Consulte la sección sobre **INSTRUCCIONES DE MATERIALES DE ACABADO** y asegúrese de que entiende perfectamente dónde se deben usar materiales no combustibles).

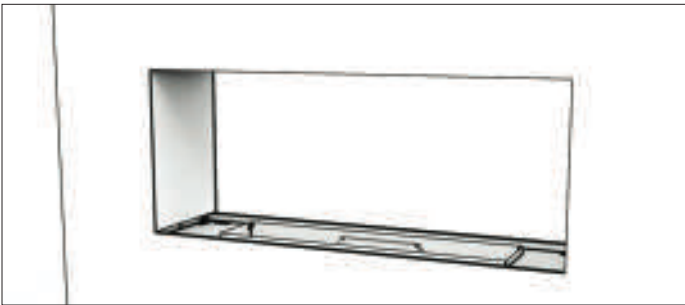

8. Coloque el quemador en posición.

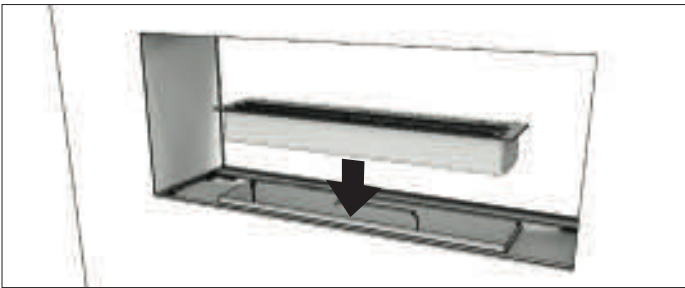

9. Retire la cinta protectora que cubre las ranuras de montaje del vidrio protector.

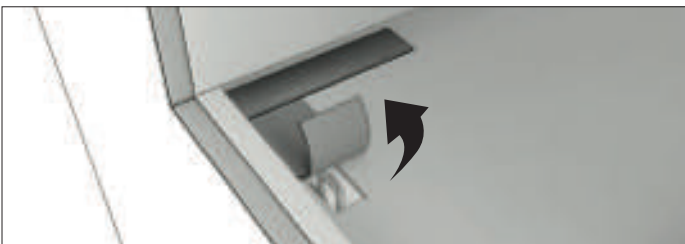

10. Si su inserto incluye una caja decorativa a la izquierda / derecha o ambas, inserte el / los panel (es) de vidrio interno (s) introduciendo el vidrio hacia arriba en la ranura y luego empujando hacia abajo en los clips colocados.

* Los troncos decorativos **NO** se deben colocar directamente sobre una llama abierta. Están diseñados para sentarse cerca del calor, pero no encima de las llamas.

11. Instale el vidrio protector insertando los dos extremos en las ranuras apropiadas del inserto. Use una pequeña cantidad de presión para empujar el vidrio protector en su lugar hasta que toque el fondo de los clips de vidrio ocultos.

ADVERTENCIA: el vidrio utilizado es vidrio templado, significa que es más resistente que el vidrio normal. Es importante destacar que, a pesar de que es más resistente, el vidrio templado aún tiene debilidades. Las esquinas y los lados son puntos de presión específicos donde es más frágil y pueden romperse si no se tiene cuidado. El vidrio se rompe en muchos pedazos pequeños. Tenga cuidado de evitar los cortes. Le recomendamos usar guantes protectores cuando manipule vidrio.

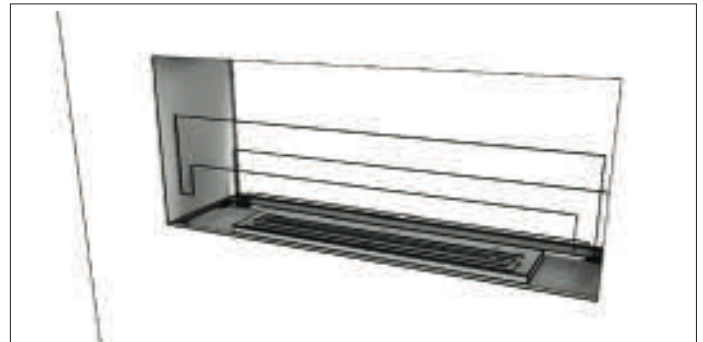

12. Extienda los guijarros antracita de manera uniforme alrededor de la bandeja del aparato. **PRECAUCIÓN:** Asegúrese de que la tapa del quemador esté cerrada. Mantenga los guijarros antracita alejado de la brida del quemador para evitar que se introduzcan accidentalmente en el tanque del quemador. Tenga cuidado de no rayar el quemador.

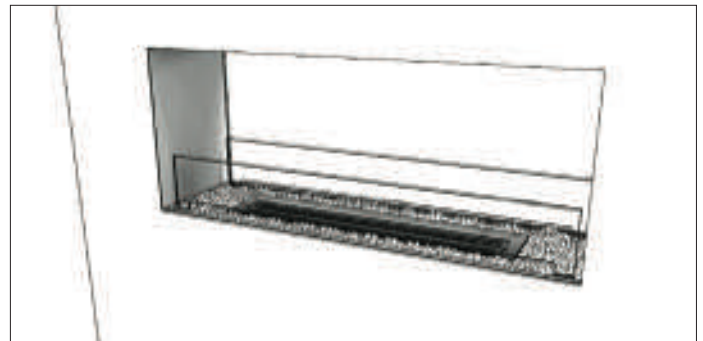

Instalación de península

Equipo requerido: taladro eléctrico, destornillador, nivel, llana de mano para yeso, pistola de silicona, pistola de calafatear.

1. Construya el marco de la pared principal con las enmarcaciones ilustradas en la Tabla E. La base del marco puede ser un banco / plataforma sólida, que ayudará a nivelar el inserto cuando esté en posición.

Advertencia: los insertos de tres lados no pueden instalarse en una pared de cavidad unidireccional, debe ser una cavidad de dos vías donde el vidrio en todos los lados esté libre de obstrucciones. No aplique presión ni materiales sobre el vidrio. Los insertos de triple cara están diseñados como inserciones divisorias. Si no cumple con estas instrucciones de instalación, la pared podría sobrecalentarse y incendiarse.



Tabla E: Enmarcaciones

Las dimensiones del modelo real deben compararse con las dimensiones del corte ANTES de la instalación final para confirmar una alineación perfecta.

INSERTO	AN mm [in]	F mm [in]	A mm [in]	Peso* kg [lbs]
FLEX18PN	470 [18.5]	349 [13.6]	730 [28.7]	34.2 [75.2]
FLEX32PN	902 [35.5]	349 [13.6]	730 [28.7]	49.8 [109.6]
FLEX42PN	1157 [45.5]	349 [13.6]	730 [28.7]	64.7 [142.3]
FLEX50PN	1362 [53.6]	349 [13.6]	730 [28.7]	59.1 [130]
FLEX50PN.BX	1362 [53.6]	349 [13.6]	730 [28.7]	73.2 [161]
FLEX60PN.BX	1617 [63.7]	349 [13.6]	730 [28.7]	87.5 [192.5]
FLEX68PN	1822 [71.7]	349 [13.6]	730 [28.7]	102.8 [226.2]
FLEX68PN.BX	1822 [71.7]	349 [13.6]	730 [28.7]	83.9 [184.6]
FLEX68PN.BX2	1822 [71.7]	349 [13.6]	730 [28.7]	96.1 [211.4]
FLEX78PN.BX2	2077 [81.8]	349 [13.6]	730 [28.7]	110.4 [242.9]
FLEX86PN	2282 [89.8]	349 [13.6]	730 [28.7]	102.5 [225.5]
FLEX86PN.BX	2282 [89.8]	349 [13.6]	730 [28.7]	124.1 [273]
FLEX86PN.BX2	2282 [89.8]	349 [13.6]	730 [28.7]	108.7 [239.1]
FLEX104PN	2742 [107.9]	349 [13.6]	730 [28.7]	153.3 [337.3]
FLEX104PN.BX	2742 [107.9]	349 [13.6]	730 [28.7]	127.3 [280.1]
FLEX104PN.BX2	2742 [107.9]	349 [13.6]	730 [28.7]	147.3 [324.1]
FLEX122PN	3202 [126.1]	349 [13.6]	730 [28.7]	145.8 [320.8]
FLEX122PN.BX	3202 [126.1]	349 [13.6]	730 [28.7]	176.2 [387.6]
FLEX122PN.BX2	3202 [126.1]	349 [13.6]	730 [28.7]	152.1 [334.6]
FLEX140PN.BX	3662 [144.2]	349 [13.6]	730 [28.7]	170.6 [375.3]
FLEX140PN.BX2	3662 [144.2]	349 [13.6]	730 [28.7]	198.7 [437.1]
FLEX158PN	4122 [162.3]	349 [13.6]	730 [28.7]	231.8 [510]
FLEX158PN.BX2	4122 [162.3]	349 [13.6]	730 [28.7]	195.4 [429.9]

* El peso del inserto incluye el / los quemador(es) (peso seco sin combustible), guijarros y vidrio. NO incluyen los guijarros antracita para las cajas decorativas laterales.

IMPORTANTE: El marco sobre la chimenea debe ser autosuficiente. El producto no soporta cargas.

2. Retire la brida de extensión de la chimenea para que ambos lados tengan la misma altura. Esto ayudará a facilitar el deslizamiento de la chimenea en el marco. Preste atención para no perder los tornillos, ya que serán necesarios cuando se vuelva a instalar la brida.

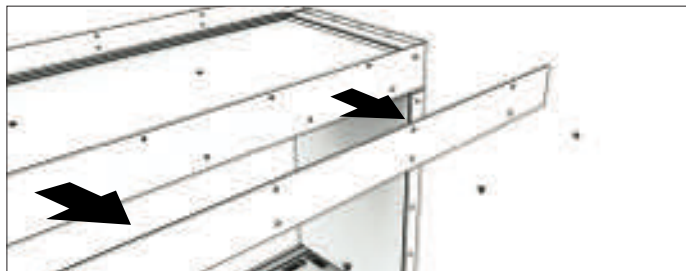

3. Deslice el inserto dentro de la cavidad del marco (La bandeja inferior se puede sentar directamente en la parte superior del marco). El inserto está mandado con soportes de estabilidad rojos instalados en el (los) lado (s) abierto (s) para mantener el cuadrado del inserto durante el transporte y durante la instalación. Mantenga el (los) soporte (s) mientras enmarca la configuración para ayudar a minimizar el movimiento de la chimenea.

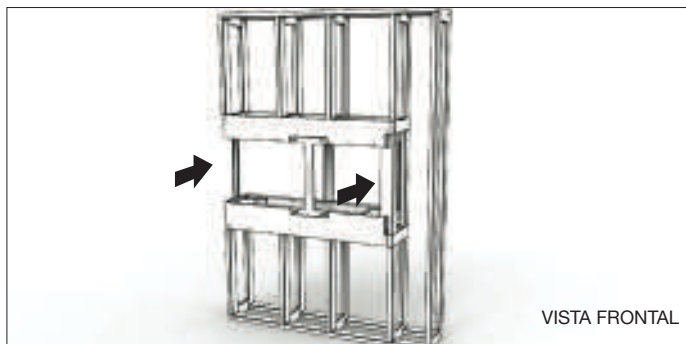

4. Asegúrese de que el borde lateral posterior y abierto del inserto estén al mismo nivel con los postes del marco.

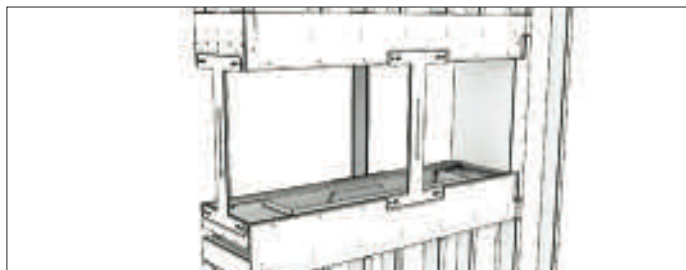

5. Alinee el panel de extensión de la brida con los orificios roscados del aparato. Atorníllelo en su lugar con los tornillos incluidos (fila inferior en el inserto, fila superior en el material de la estructura) para fijarlo en su posición.



Instalación de península

6. Fije el inserto al marco con tornillos utilizando los orificios de montaje existentes en sus bridas. Asegúrese de que el inserto esté nivelado antes de instalarlo en su lugar.

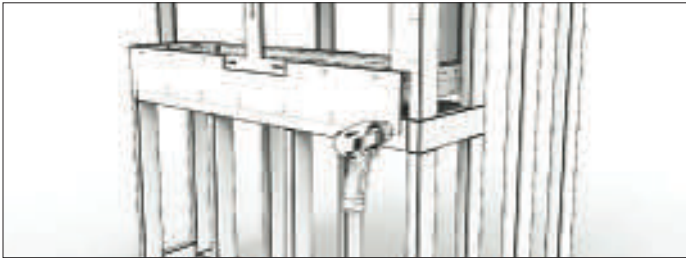

7. Retire los soportes de estabilidad rojos.

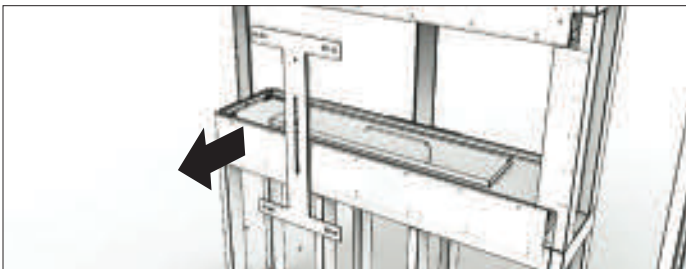

8. Complete la construcción terminando con los paneles de pared alrededor del inserto. (Consulte la sección sobre **INSTRUCCIONES DE MATERIALES DE ACABADO** y asegúrese de que entienda perfectamente dónde se deben usar materiales no combustibles).



9. Coloque el quemador en posición.

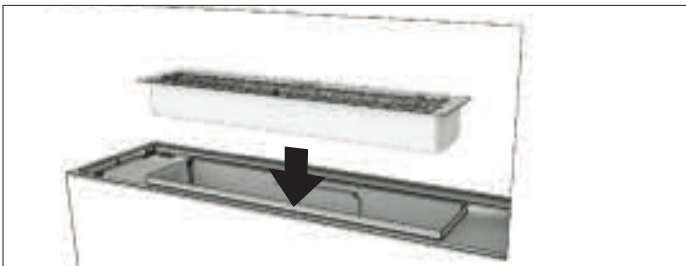

10. Retire la cinta protectora que cubre las ranuras de montaje del vidrio protector.

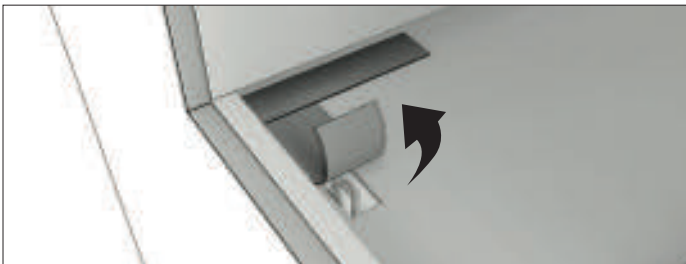

11. Si su inserto incluye una caja decorativa a la izquierda / derecha o ambas, inserte el / los panel (es) de vidrio interno (s) introduciendo el vidrio hacia arriba en la ranura y luego empujando hacia abajo en los clips colocados.

** Los troncos decorativos NO se deben colocar directamente sobre una llama abierta. Están diseñados para sentarse cerca del calor, pero no encima de las llamas.*

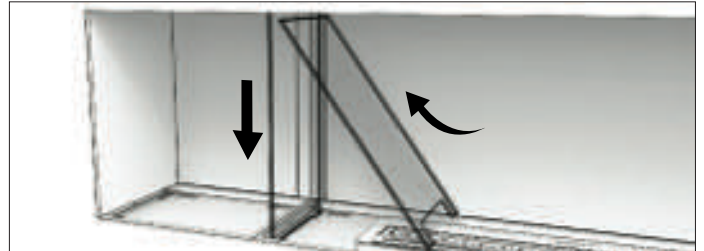

12. Insert the full height glass panel into the open end side by inserting the glass into the opening at the top of the appliance, and lowering it into the slots in the base until it bottoms out into place.

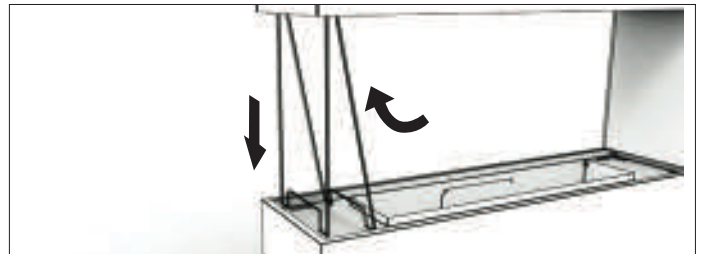

13. Instale el vidrio protector insertando los dos extremos en las ranuras apropiadas del inserto. Use una pequeña cantidad de presión para empujar el vidrio protector en su lugar hasta que toque el fondo de los vidrios ocultos.

ADVERTENCIA: el vidrio utilizado es vidrio templado, significa que es más resistente que el vidrio normal. Es importante destacar que, a pesar de que es más resistente, el vidrio templado aún tiene debilidades. Las esquinas y los lados son puntos de presión específicos donde es más frágil y pueden romperse si no se tiene cuidado. El vidrio se rompe en muchos pedazos pequeños. Tenga cuidado de evitar los cortes. Le recomendamos usar guantes protectores cuando manipule vidrio.

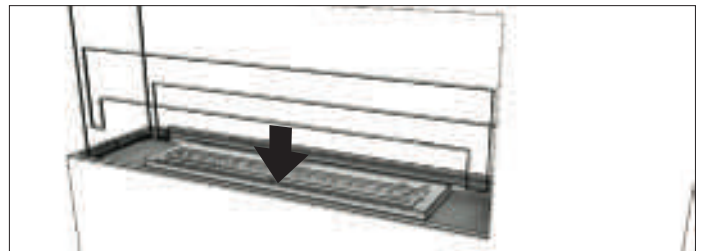

14. Extienda los guijarros antracita de manera uniforme alrededor de la bandeja del aparato. **PRECAUCIÓN:** Asegúrese de que la tapa del quemador esté cerrada. Mantenga los guijarros antracita alejado de la brida del quemador para evitar que se introduzcan accidentalmente en el tanque del quemador. Tenga cuidado de no rayar el quemador.

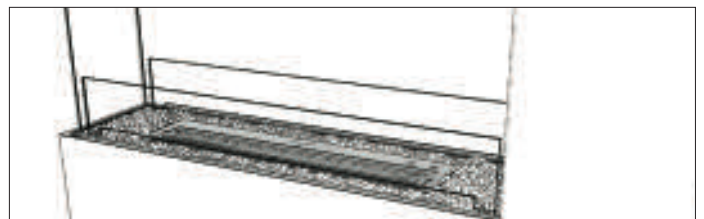

Instalación de Isla

Equipo requerido: taladro eléctrico, destornillador, nivel, llana de mano para yeso, pistola de silicona, pistola de calafatear.

1. Construya el marco con el tamaño de apertura que se muestra en la Tabla F. La base del marco puede ser un banco / plataforma sólida, que ayudará a nivelar el inserto cuando esté en posición.

ADVERTENCIA: Este aparato de cuatro lados no se puede insertar en una estructura de pared. Debe instalarse en un marco separado firmemente anclado al piso. No lo instale en estructuras móviles o débiles. La parte superior del aparato debe instalarse en un marco asegurado al techo y alineado con el marco inferior. Los electrodomésticos de cuatro lados están diseñados como insertos divisores de pared. Si no cumple con estas instrucciones de instalación, la pared podría sobrecalentarse y incendiarse.



Tabla F: Enmarcaciones

Las dimensiones del modelo real deben compararse con las dimensiones del corte ANTES de la instalación final para confirmar una alineación perfecta.

INSERTO	AN mm [in]	F mm [in]	A mm [in]	Peso* kg [lbs]
FLEX18IL	455 [17.9]	349 [13.6]	730 [28.7]	22.2 [48.9]
FLEX32IL	887 [34.9]	349 [13.6]	730 [28.7]	33.5 [73.7]
FLEX42IL	1142 [45]	349 [13.6]	730 [28.7]	49.8 [109.6]
FLEX50IL	1347 [53]	349 [13.6]	730 [28.7]	59.9 [131.8]
FLEX50IL.BX	1347 [53]	349 [13.6]	730 [28.7]	48.3 [106.3]
FLEX60IL.BX	1602 [63.1]	349 [13.6]	730 [28.7]	64.6 [142.2]
FLEX68IL	1807 [71.1]	349 [13.6]	730 [28.7]	75.2 [165.5]
FLEX68IL.BX	1807 [71.1]	349 [13.6]	730 [28.7]	74.7 [164.4]
FLEX68IL.BX2	1807 [71.1]	349 [13.6]	730 [28.7]	63.1 [138.9]
FLEX78IL.BX2	2062 [81.2]	349 [13.6]	730 [28.7]	79.4 [174.8]
FLEX86IL	2267 [89.3]	349 [13.6]	730 [28.7]	101.5 [223.2]
FLEX86IL.BX	2267 [89.3]	349 [13.6]	730 [28.7]	90 [198.1]
FLEX86IL.BX2	2267 [89.3]	349 [13.6]	730 [28.7]	89.5 [197]
FLEX104IL	2727 [107.4]	349 [13.6]	730 [28.7]	116.3 [255.9]
FLEX104IL.BX	2727 [107.4]	349 [13.6]	730 [28.7]	116.3 [255.9]
FLEX104IL.BX2	2727 [107.4]	349 [13.6]	730 [28.7]	104.8 [230.6]
FLEX122IL	3187 [125.5]	349 [13.6]	730 [28.7]	148.6 [327]
FLEX122IL.BX	3187 [125.5]	349 [13.6]	730 [28.7]	131.1 [288.4]
FLEX122IL.BX2	3187 [125.5]	349 [13.6]	730 [28.7]	131.1 [288.4]
FLEX140IL.BX	3647 [143.6]	349 [13.6]	730 [28.7]	163.4 [359.6]
FLEX140IL.BX2	3647 [143.6]	349 [13.6]	730 [28.7]	145.9 [321.1]
FLEX158IL	4107 [161.7]	349 [13.6]	730 [28.7]	173.9 [382.6]
FLEX158IL.BX2	4107 [161.7]	349 [13.6]	730 [28.7]	178.3 [392.2]

* El peso del inserto incluye el / los quemador(es) (peso seco sin combustible), guijarros y vidrio. NO incluyen los guijarros antracita para las cajas decorativas laterales.

IMPORTANTE: El marco sobre la chimenea debe ser autosuficiente. El producto no soporta cargas.

2. Retire la brida de extensión de la chimenea para que ambos lados tengan la misma altura. Esto ayudará a facilitar el deslizamiento de la chimenea en el marco. Preste atención para no perder los tornillos, ya que serán necesarios cuando se vuelva a instalar la brida.

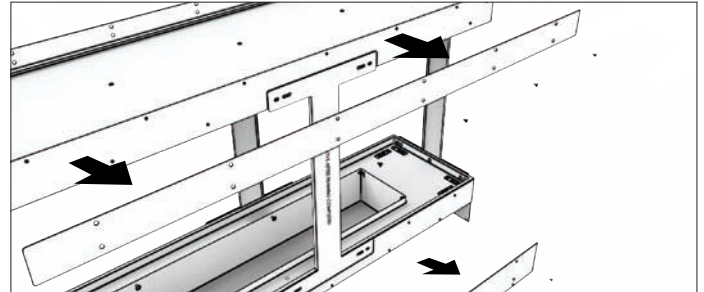

3. Deslice el inserto dentro de la cavidad del marco (La bandeja inferior se puede sentar directamente en la parte superior del marco). El inserto está mandado con soportes de estabilidad rojos instalados en el (los) lado (s) abierto (s) para mantener el cuadrado del inserto durante el transporte y durante la instalación. Mantenga el (los) soporte (s) mientras enmarca la configuración para ayudar a minimizar el movimiento de la chimenea.

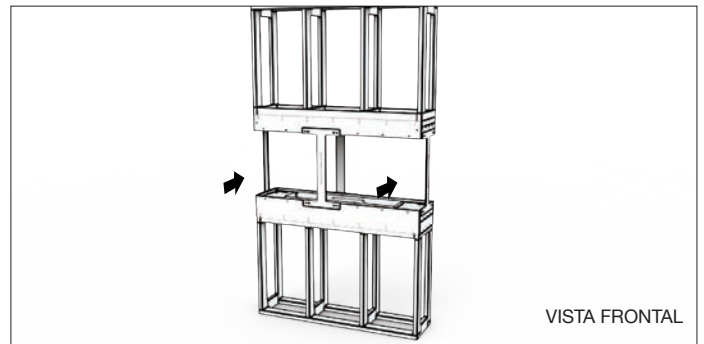

4. Alinee el panel de extensión de la brida con los orificios roscados del aparato. Atorníllelo en su lugar con los tornillos incluidos (fila inferior en el inserto, fila superior en el material de la estructura) para fijarlo en su posición.

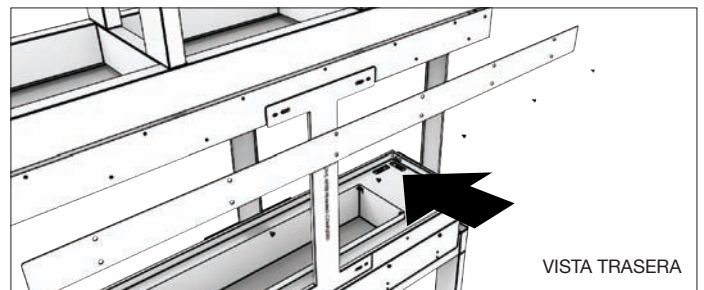

5. Fije el inserto al marco con tornillos utilizando los orificios de montaje existentes en sus bridas. Asegúrese de que el inserto esté nivelado antes de instalarlo en su lugar.

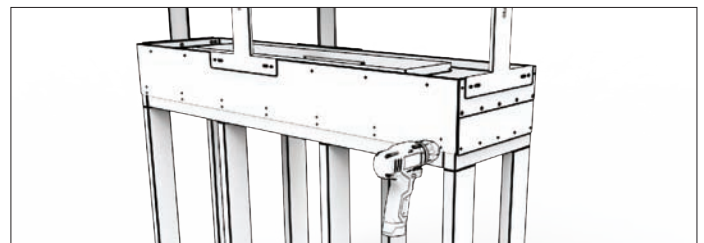

6. Retire los soportes de estabilidad rojos.

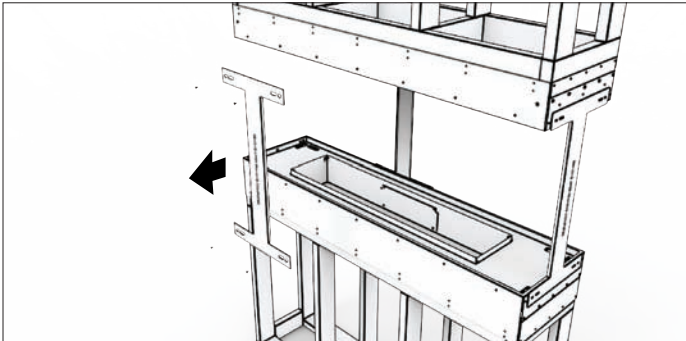

7. Complete la construcción terminando con los paneles de pared alrededor del inserto. (Consulte la sección sobre **INSTRUCCIONES DE MATERIALES DE ACABADO** y asegúrese de que entienda perfectamente dónde se deben usar materiales no combustibles).

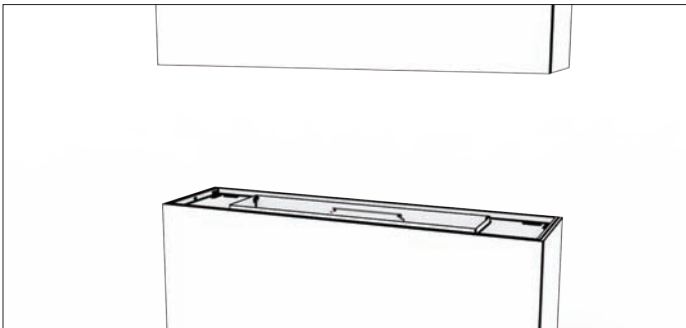

8. Coloque el quemador en posición.

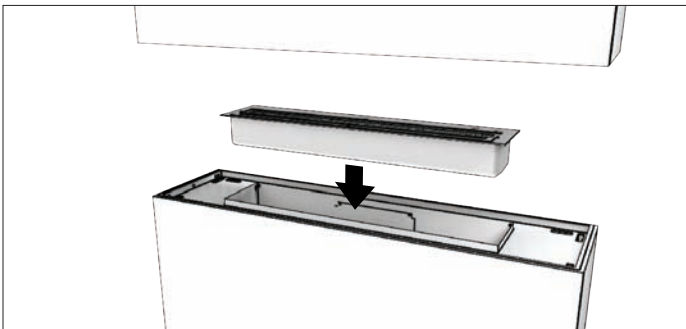

9. Retire la cinta protectora que cubre las ranuras de montaje del vidrio protector.

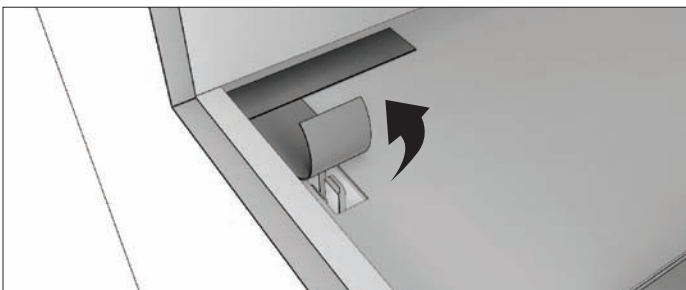

10. Instale el vidrio protector insertando los dos extremos en las ranuras apropiadas del inserto. Use una pequeña cantidad de presión para empujar el vidrio protector en su lugar hasta que toque el fondo de los clips de vidrio ocultos. Repita lo mismo para el vidrio trasero y si su aparato incluye una caja decorativa a la izquierda/derecha o ambas.

** Los troncos decorativos NO se deben colocar directamente sobre una llama abierta. Están diseñados para sentarse cerca del calor, pero no encima de las llamas. Agregue solo un conjunto de registros decorativos a este estilo de modelo.*

ADVERTENCIA: el vidrio utilizado es vidrio templado, significa que es más resistente que el vidrio normal. Es importante destacar que, a pesar de que es más resistente, el vidrio templado aún tiene debilidades. Las esquinas y los lados son puntos de presión específicos donde es más frágil y pueden romperse si no se tiene cuidado. El vidrio se rompe en muchos pedazos pequeños. Tenga cuidado de evitar los cortes. Le recomendamos usar guantes protectores cuando manipule vidrio.

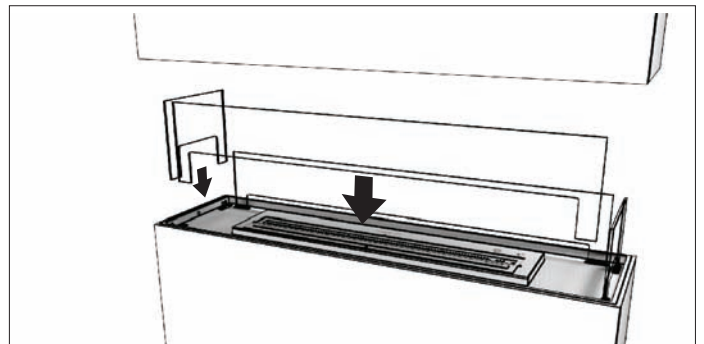

11. Extienda los guijarros antracita de manera uniforme alrededor de la bandeja del aparato. **PRECAUCIÓN:** Asegúrese de que la tapa del quemador esté cerrada. Mantenga los guijarros antracita alejado de la brida del quemador para evitar que se introduzcan accidentalmente en el tanque del quemador. Tenga cuidado de no rayar el quemador.

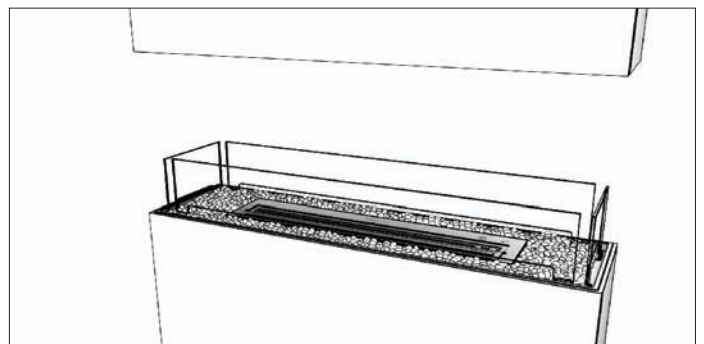

Instalación de Banco

Equipo requerido: taladro eléctrico, destornillador, nivel, llana de mano para yeso, pistola de silicona, pistola de calafatear.

1. Construya el marco principal utilizando las dimensiones que se muestran en la Tabla G. La base del marco puede ser un banco / plataforma sólida, que ayudará a nivelar el inserto cuando esté en posición. Cuando planifique la construcción, asegúrese de que haya un espacio libre mínimo de 1500 mm (59.1") desde la abertura del quemador hasta el techo.

ADVERTENCIA: Este aparato de cuatro lados no se puede insertar en una estructura de pared. Debe instalarse en un marco separado firmemente anclado al piso. La parte superior del aparato debe instalarse en un marco asegurado al techo y alineado con el marco inferior. Los electrodomésticos de cuatro lados están diseñados como insertos divisores de pared.

2. Retire la brida de extensión de la chimenea para que ambos lados tengan la misma altura. Esto ayudará a facilitar el deslizamiento de la chimenea en el marco. Preste atención para no perder los tornillos, ya que serán necesarios cuando se vuelva a instalar la brida.

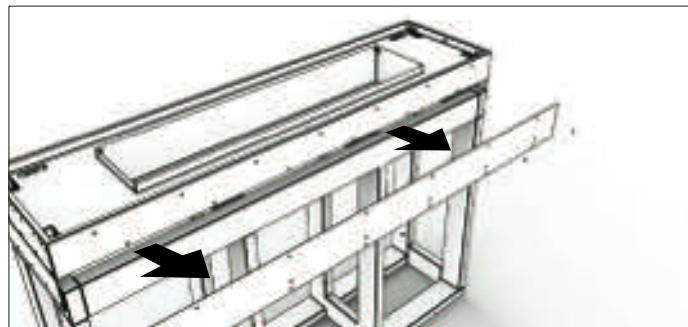

3. Deslice el inserto dentro de la cavidad del marco (La bandeja inferior se puede sentar directamente en la parte superior del marco).



Tabla G: Tamaños de marco

Las dimensiones del modelo real deben compararse con las dimensiones del corte ANTES de la instalación final para confirmar una alineación perfecta.

INSERTO	AN mm [in]	F mm [in]	Peso* kg [lbs]
FLEX18BN	455 [17.9]	349 [13.6]	18.3 [40.2]
FLEX32BN	887 [34.9]	349 [13.6]	27.5 [60.6]
FLEX42BN	1142 [45]	349 [13.6]	33.8 [74.4]
FLEX50BN	1347 [53]	349 [13.6]	39.5 [86.9]
FLEX50BN.BX	1347 [53]	349 [13.6]	38.4 [84.5]
FLEX60BN.BX	1602 [63.1]	349 [13.6]	44.7 [98.4]
FLEX68BN	1807 [71.1]	349 [13.6]	50.3 [110.6]
FLEX68BN.BX	1807 [71.1]	349 [13.6]	61.1 [134.5]
FLEX68BN.BX2	1807 [71.1]	349 [13.6]	49.3 [108.5]
FLEX78BN.BX2	2062 [81.2]	349 [13.6]	55.6 [122.4]
FLEX86BN	2267 [89.3]	349 [13.6]	71.6 [157.5]
FLEX86BN.BX	2267 [89.3]	349 [13.6]	61.1 [134.5]
FLEX86BN.BX2	2267 [89.3]	349 [13.6]	61.3 [134.8]
FLEX104BN	2727 [107.4]	349 [13.6]	80 [176]
FLEX104BN.BX	2727 [107.4]	349 [13.6]	82.5 [181.5]
FLEX104BN.BX2	2727 [107.4]	349 [13.6]	72 [158.5]
FLEX122BN	3187 [125.5]	349 [13.6]	105.6 [232.4]
FLEX122BN.BX	3187 [125.5]	349 [13.6]	90.9 [200]
FLEX122BN.BX2	3187 [125.5]	349 [13.6]	93.4 [205.5]
FLEX140BN.BX	3647 [143.6]	349 [13.6]	116.5 [256.3]
FLEX140BN.BX2	3647 [143.6]	349 [13.6]	101.8 [224]
FLEX158BN	4107 [161.7]	349 [13.6]	118.8 [261.4]
FLEX158BN.BX2	4107 [161.7]	349 [13.6]	127.4 [280.3]

4. Alinee el panel de extensión de la brida con los orificios roscados del aparato. Atornillelo en su lugar con los tornillos incluidos (fila inferior en el inserto, fila superior en el material de la estructura) para fijarlo en su posición.

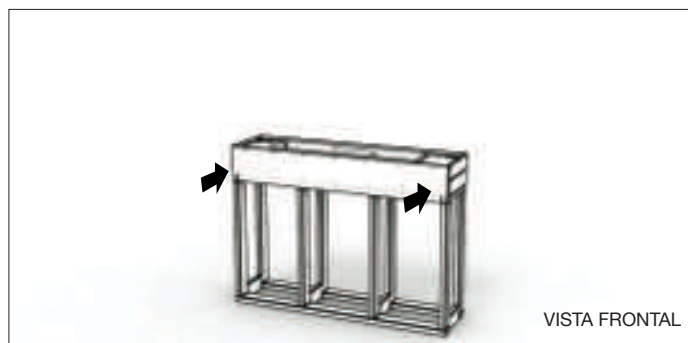

5. Fije el inserto al marco con tornillos utilizando los orificios de montaje existentes en sus bridas. Asegúrese de que el inserto esté nivelado antes de instalarlo en su lugar.



* El peso del inserto incluye el / los quemador(es) (peso seco sin combustible), guijarros y vidrio. NO incluyen los guijarros antracita para las cajas decorativas laterales.

6. Complete la construcción terminando con los paneles de pared alrededor del inserto. (Consulte la sección sobre **INSTRUCCIONES DE MATERIALES DE ACABADO** y asegúrese de que entienda perfectamente dónde se deben usar materiales no combustibles).



7. Coloque el quemador en posición.

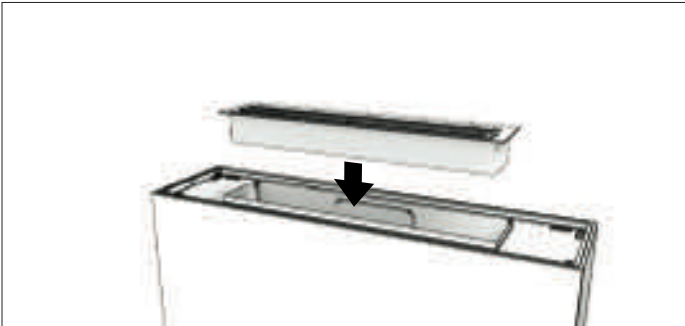

8. Retire la cinta protectora que cubre las ranuras de montaje del vidrio protector.

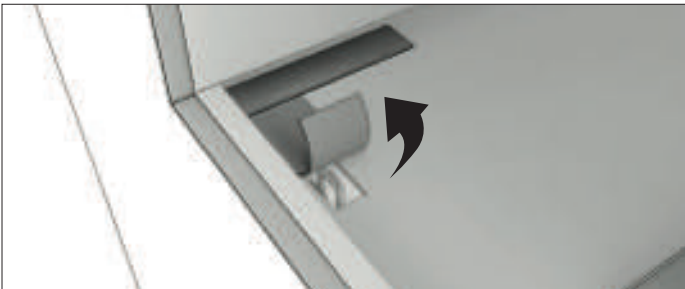

9. 11. Instale el vidrio protector insertando los dos extremos en las ranuras apropiadas del inserto. Use una pequeña cantidad de presión para empujar el vidrio protector en su lugar hasta que toque el fondo de los clips de vidrio ocultos. Repita lo mismo para el vidrio trasero y si su aparato incluye una caja decorativa a la izquierda/ derecha o ambas.

**Decorative logs must NOT be placed directly over an open flame. They are designed to sit near heat but not over flames. Agregue solo un conjunto de registros decorativos a este estilo de modelo.*

ADVERTENCIA: el vidrio utilizado es vidrio templado, significa que es más resistente que el vidrio normal. Es importante destacar que, a pesar de que es más resistente, el vidrio templado aún tiene debilidades. Las esquinas y los lados son puntos de presión específicos donde es más frágil y pueden romperse si no se tiene cuidado. El vidrio se rompe en muchos pedazos pequeños. Tenga cuidado de evitar los cortes. Le recomendamos usar guantes protectores cuando manipule vidrio.

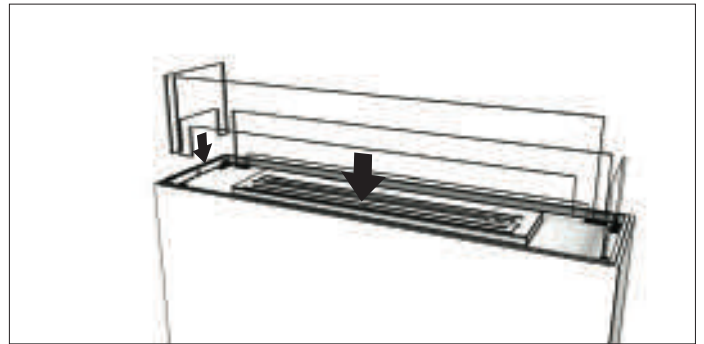

10. Extienda los guijarros antracita de manera uniforme alrededor de la bandeja del aparato. PRECAUCIÓN: Asegúrese de que la tapa del quemador esté cerrada. Mantenga los guijarros antracita alejado de la brida del quemador para evitar que se introduzcan accidentalmente en el tanque del quemador. Tenga cuidado de no rayar el quemador.

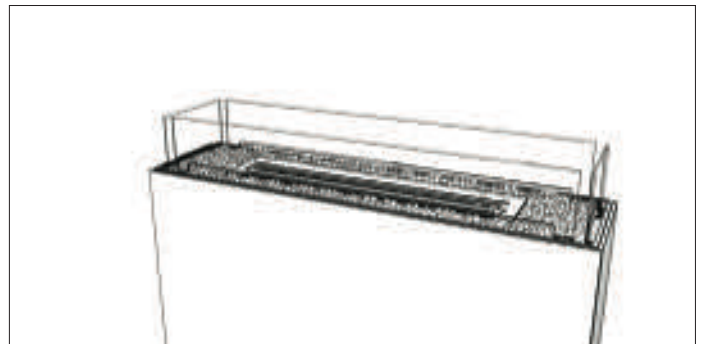

Materiales De acabado

1. Aplique paneles de pared circundantes. Los materiales aceptables incluyen tableros de fibrocemento, tableros de fibra de densidad media resistentes al fuego (FR MDF), piedra, azulejos, acero y paneles de yeso resistentes al fuego (FR).

Los materiales de revestimiento o acabado nunca deben sobresalir en la abertura del aparato.

¡ADVERTENCIA! ¡Riesgo de fuego! No aplique materiales combustibles más allá de las distancias mínimas. Cumpla con todas las distancias mínimas de los combustibles como se especifica en este manual y en el manual del quemador.

IMPORTANTE: se debe instalar un panel no combustible de 155 mm [6"] sobre todos los lados de las aberturas del inserto. Ver ejemplos a continuación.



Ejemplo: Chimenea de una cara



Ejemplo: Chimenea Península

2. DEBE instalarse un reborde de metal en todos los bordes (mitra las esquinas). (No use sujetadores largos más gruesos que el material de los paneles de pared para evitar que penetre en el aparato).

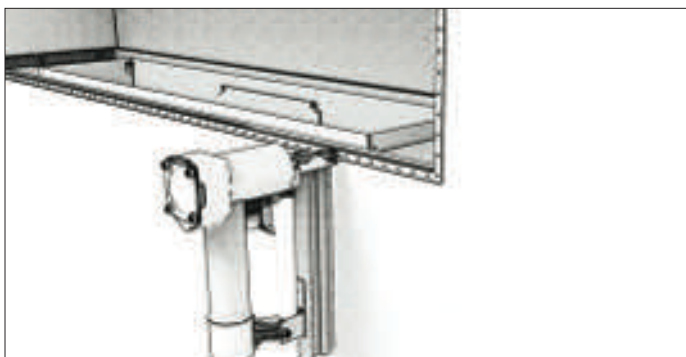

3. Enyesa todas las costuras y abalorios.

Todas las juntas entre el revestimiento de la pared terminada y la parte frontal del inserto deben estar selladas con materiales no combustibles. Los selladores, como la masilla o masilla utilizada para sellar el espacio entre la pared y el inserto, deben tener una resistencia térmica mínima de 150 ° C (122 ° F).

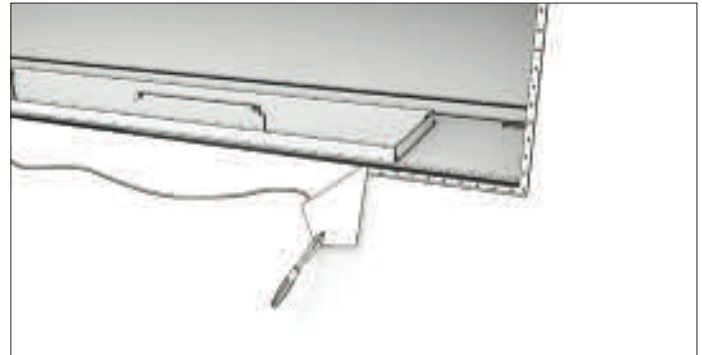

4. Si el acabado deseado incluye una pared pintada, se puede usar látex acrílico al 100% o acrílico a base de aceite o estándar. Siga las instrucciones del fabricante para aplicaciones de pintura y pintura base.

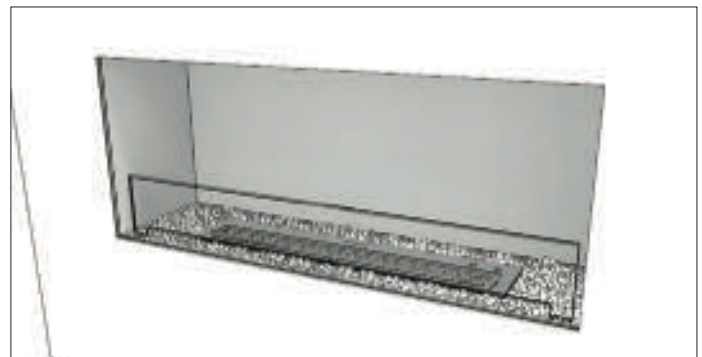

OPERA DE ACUERDO CON EL MANUAL DE OPERACIONES DEL QUEMADOR INCLUIDO CON EL QUEMADOR.

Mantos de chimeneas

Plato relleno de caja decorativa

Distancias mínimas

Si la configuración incorpora un manto, se deben respetar las dimensiones mínimas verticales y máximas horizontales del manto combustible identificadas en la siguiente imagen.

Distancia mínima a LOS MATERIALES INFLAMABLES más cercanos

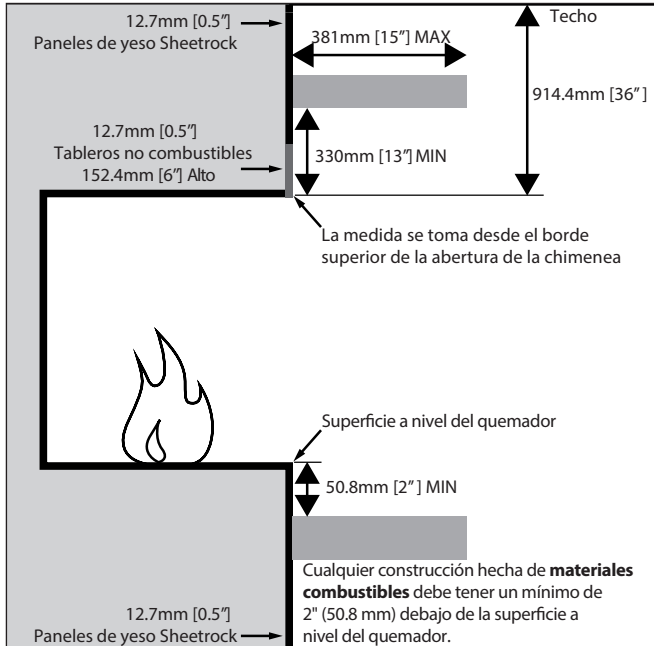

Dimensiones mínimas verticales y máximas horizontales del manto combustible.

Acabados y distancias mínimas para NO COMBUSTIBLES

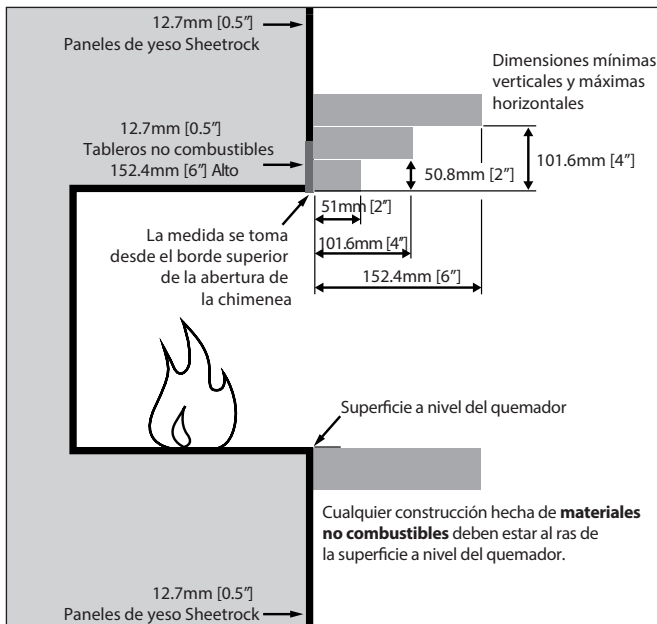

Dimensiones mínimas verticales y máximas horizontales del manto no combustible.

¡Advertencia! ¡Riesgo de fuego! Cumplir con todas las distancias mínimas a los combustibles como especificado. Los materiales de encuadre o acabado más cerca que el mínimo listado deben ser contruidos completamente con materiales no combustibles.

Para insertos con una caja decorativa lateral, se proporciona una placa de relleno para levantar el material y alinearlo con el borde inferior del inserto. Solo materiales / accesorios no combustibles deben estar colocados en las cajas decorativas.

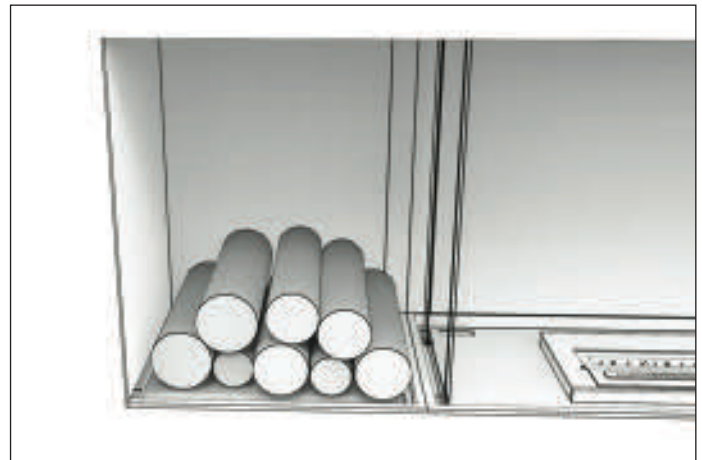
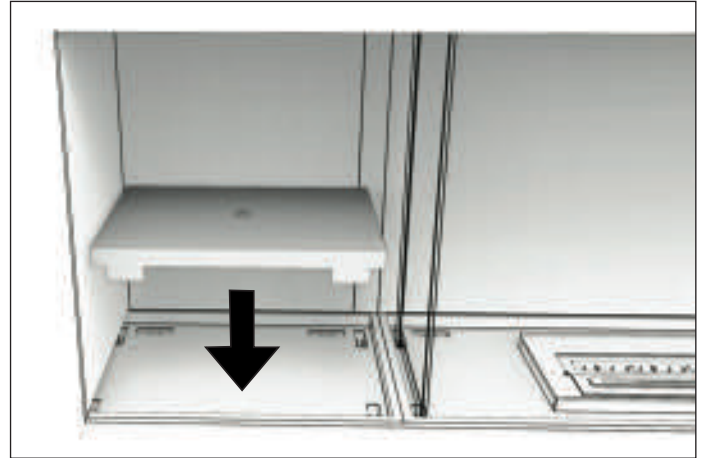

Los troncos decorativos de acero están disponibles como accesorio opcional. Por favor, póngase en contacto con customerservice@ecosmartfire.com

* Los troncos decorativos NO se deben colocar directamente sobre una llama abierta. Están diseñados para sentarse cerca del calor, pero no encima de las llamas.



MAD Design Group

Showrooms 3 & 4, 40-42 O'Riordan Street

Alexandria NSW 2015 Australia

Tel: +61 2 9997 3050 Email: info@maddesigngroup.com

REV0520