

# EF30 Air Circulation Fan User Manual

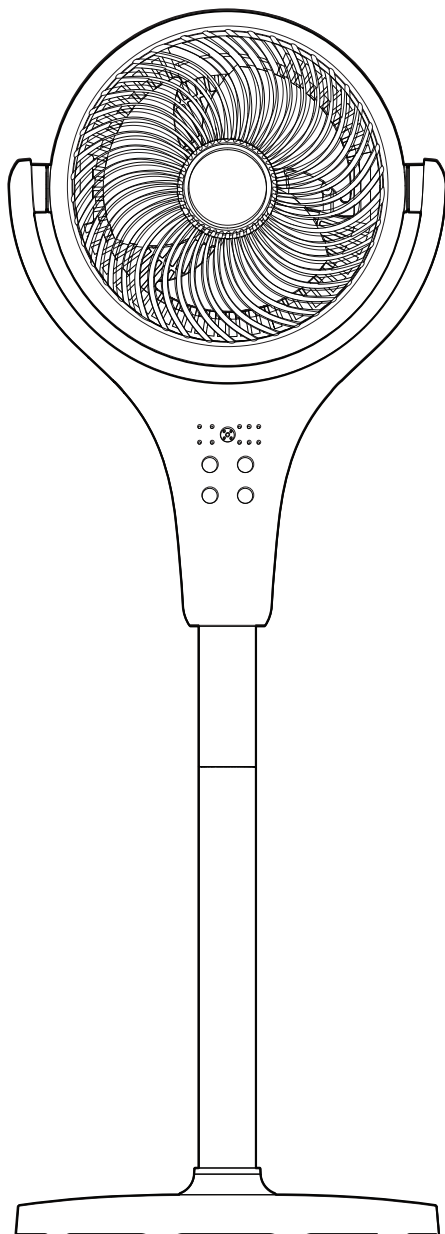

Please read this booklet thoroughly before operating the fan.

**ELUXGO**

# Product Introduction

## ⚠ NOTICE ⚠

The pictures in the instruction manual are for reference only. The actual product in the box shall prevail.

## Part Name

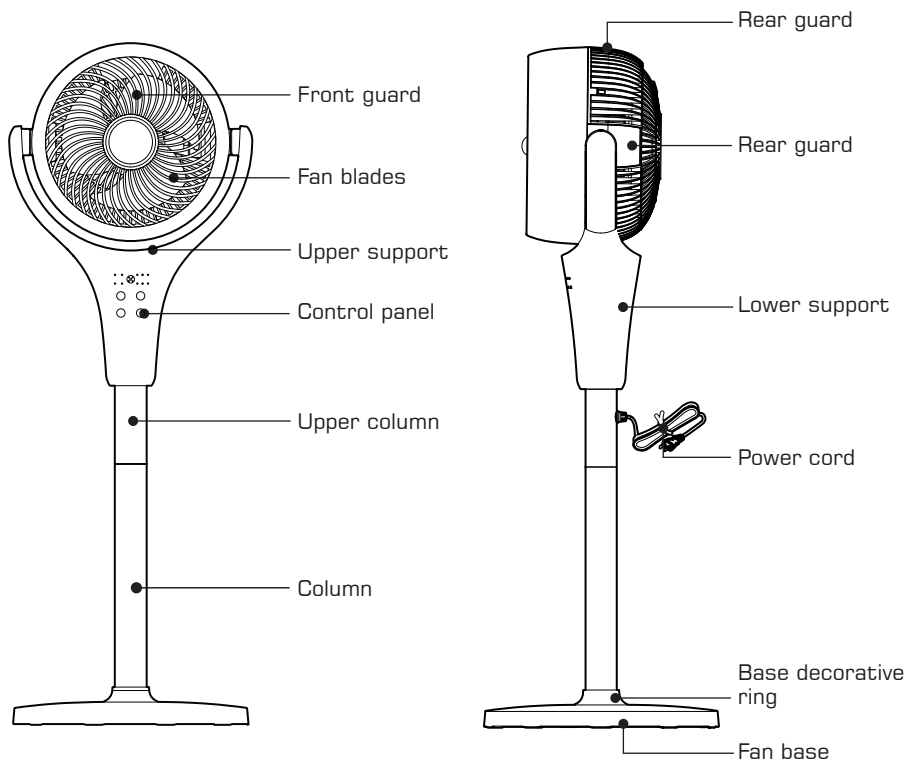

## Accessories



Instruction Manual



Remote Control

# Usage

## Control panel





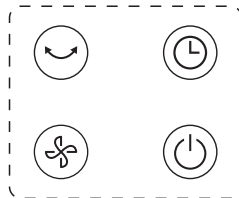

Display



Button

## Button Description

Function	Description
	<ol style="list-style-type: none"> <li>1. Plug in the power supply and it enters standby mode. Press this button to start the fan. During the first use, the startup wind speed is "3". If the fan is turned on again after standby mode, the fan defaults to the wind speed that was last used.</li> <li>2. When the fan is running, press this key again to stop the fan.</li> </ol>
	<ol style="list-style-type: none"> <li>1. Short press this button to adjust the wind speed, long press this button to change the mode.</li> <li>2. When the fan is running, press this button to toggle the wind speed in the following cycle (1-2-3-1...); the corresponding speed indicator will be on.</li> <li>3. When the fan is running, press and hold this button to change the wind mode; Press and hold to toggle between these modes (Whirlwind - ECO wind - Baby wind - Normal mode - Whirlwind....) The default is normal mode. The wind speed can only be adjusted in normal mode, and not in other wind modes.</li> </ol>
	<ol style="list-style-type: none"> <li>1. Press the button once, fan head oscillates left &amp; right, up &amp; down at the same time. There will be no light indication;</li> <li>2. Press the button for a second time, only left &amp; right oscillation, up &amp; down oscillation will be turned off. There will be no light indication;</li> <li>3. Press the button for the third time, only up &amp; down oscillation, left &amp; right oscillation will be turned off. There will be no light indication;</li> <li>4. Press the button for the fourth time, all oscillations to cease.</li> </ol>
	<p>When the fan is running, you can press this button to set the timer to off the fan. Press this button to set the timer in the following duration cycle (2h -- 4h -- 6h -- 8h --cancel timer --2h -- 4h--...), the corresponding light indicator will light up.</p>











### Note:

1. Short press this button to adjust the wind speed, long press this button to change the mode.
2. When the fan is running, press this button to toggle the wind speed in the following cycle (1-2-3-1...); the corresponding speed indicator will be on.
3. With a continuous power supply while the fan is in standby mode, the oscillating head will return to its original position.
4. Wind Modes :
  - 4-1. Whirlwind : The "3" wind speed of normal mode will be turned on.
  - 4-2. ECO wind : Simulate the effect of natural wind blowing.
  - 4-3. Baby wind : The "1" wind speed of normal mode will be turned on.
5. Timer set function : Function can only be controlled on the remote control.

# Remote Control Operating Instruction

## ⚠ NOTICE ⚠

- Remove the insulation sheet from the remote control before use.
- Batteries contain many heavy metals, acids, alkali and other substances, which threaten human health; Waste batteries should be recycled accordingly.

Function	Function Description
	On/Standby
	Turn off or on the indicator light.
	Switch wind mode.
	Fan to start up after the appointed time, for up to 8h. This function can only set the appointed time to start the fan; the fan speed and oscillation cannot be pre-set.
	Set the appointed shutdown time, up to 8h.
	Turn on/off the left & right head oscillation.
	Turn on/off the up & down head oscillation.
	Turn off or on the control panel buzzer sound.
	Toggle between the fan speeds.
	

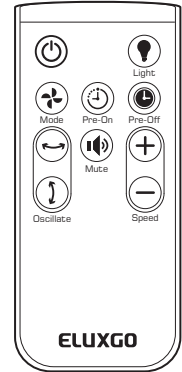

### Polarity of battery

Incorrect installation will cause leakage and corrosion of the battery and damage the remote control.

Please observe the following precautions:

1. When replacing the battery, be sure to use a brand new battery
2. Do not attempt to change, short circuit or disassemble the battery to avoid danger.
3. Please install the battery according to the + and - polarity as shown.
4. When not in use for extended periods, please take out the battery to avoid battery leakage.

 Please recycle the waste battery

※ When the battery is drained, please discard or recycle it accordingly in the bins designated by local authorities to avoid polluting the environment.

# Specifications

Item	Air Circulation Fan
Model	EF30
Voltage	AC220-240V 50/60Hz
Power	38W
N.W.	2.5kg
Size	320 (W) x 310 (D) x 604~898mm (H)
Fan Blade Diameter	180mm
Executive Standard	GB 17625.1-2012 / GB 4343.1-2018 / GB 4706.1-2005 / GB 4706.27-2008

# Electrical Diagram

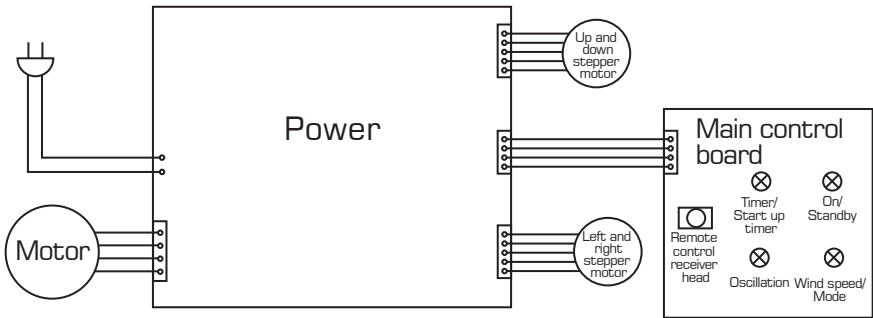

# Installation Method

## ⚠ NOTICE ⚠

When installing the fan, do not plug the power cord into the power socket.

### 1. Base installation

Align the threaded end of the column with the threaded hole of the base, and rotate the column clockwise until it is tightened.

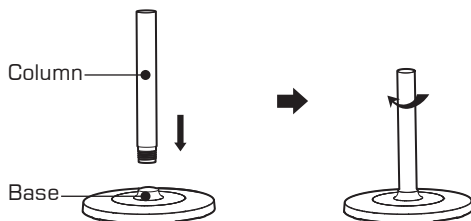

### 2. Head assembly installation

Align the threaded end of the machine head with the threaded hole of the column. Hold the head firmly while turning the column anti-clockwise until it is tightened. (The column is detachable, and the machine head can be connected to the base for use as a desk fan.)

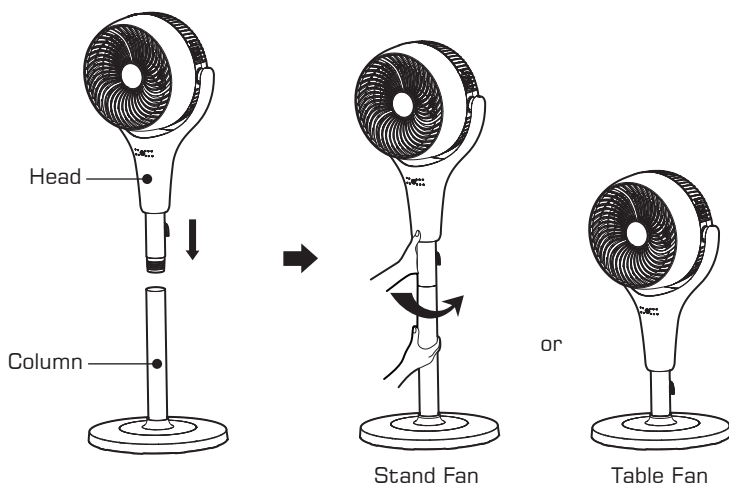

# Application Method of Swing Head

## ⚠ NOTICE ⚠

- The left and right, up and down oscillation head are automatic. Do not adjust them manually by hand.
- With a continuous power supply while the fan is in standby mode, the oscillating head will return to its original position.

### 1. Left and right wide-angle ventilation

Automatic left and right oscillation angle.

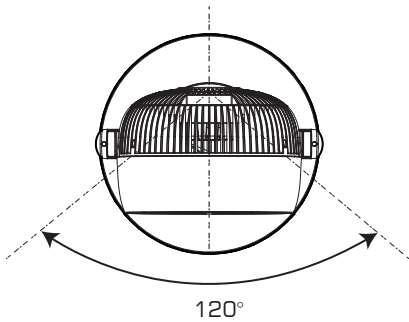

### 2. Elevation ventilation

Automatic up and down oscillation angle.

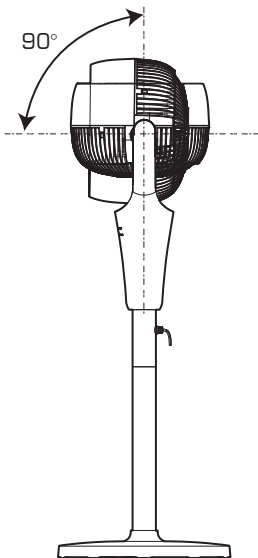

# Fault Rectifications

- If the fan cannot work normally after the following rectification, please contact the customer service center or local maintenance point.

Fault Issues	Fault Reasons	Solution
Fan does not operate	The power socket is dead	Change to a live socket
	The power cord is not connected in place	Connect the power cord correctly
Noise during operation	Dirty fan blades	Remove the front guard and clean the fan blade
	Loose fan blades	Tighten the fan blade
	Motor failure	Please send it to the dealer or contact our company for servicing
No head oscillation	Incorrect mode chosen	Please press the correct button
Fan blade stuck	The fan blade is jammed by foreign matters	Turn off the power supply of the fan and take out the foreign matters



# Safety Precautions

## ⚠ NOTICE ⚠

Please read this manual carefully before use. The company reserves the right to interpret the instructions. The appearance of the actual product shall prevail. In the case of product technology or software upgrades, there will be no prior notice.

### 1. Transporting

- When moving, be sure to stop the fan and unplug the power plug.
- Please hold the fan base or handle (belt) firmly to prevent it toppling and hurting people.

### 2. Power cord

- Before carrying out maintenance work or moving the body, please disconnect the power cord from the AC power socket.
- Do not pinch, bend or twist the AC power cord excessively, otherwise the cord may be exposed or broken.
- Do not use an inappropriate AC outlet.
- Do not use the AC power cord provided by this product on any other device.
- If the power cord is damaged, it must be replaced by professionals from the manufacturer, its maintenance department or a similar department to avoid danger.

### 3. Usage

- Please refer to the voltage and frequency ratings on the specification label before use, and ensure it is appropriate with the supplied voltage.
- Do not insert your fingers or other objects into the front and rear guard during use to avoid causing danger.
- In the case of abnormal sound, peculiar smell, high temperature, irregular rotation of the fan or other abnormalities, please stop using the product immediately.

### 4. Warning (improper use may cause, electric shock, fire, personal injury, and other damages)

- Do not use this product on unstable places where it might be toppled easily.
- Do not use this product in a place where there are unstable objects nearby.
- Do not use this product in a hot and humid environment such as the bathroom.
- Do not use this product when the power cord is damaged or the power cord plug is loose.
- Do not use this product if the front guard of the fan is not installed or the rear cover of the fan is loose or falls off.
- Do not allow children or adults who do not understand this manual to operate this product.
- It is forbidden to replace the power cord without authorization, connect the power cord halfway or use it in parallel with other electrical appliances.
- Do not place the fan body near any water source.
- It is forbidden to disassemble, refit or repair internal components without authorization.
- Do not climb or sit on this machine.
- It is forbidden to store inflammables and explosives around the fan body. Do not place them near any heat source.

# Cleaning, Maintenance and Storage

## ⚠ WARNING ⚠

- The power supply must be cut off before cleaning this product.
- It is forbidden to rinse the fan body directly with water.
- Do not use any grinding tools and solvents that will damage the surface when cleaning this product. Use detergent to clean it and wipe it with a dry cloth promptly.
- It is forbidden to disassemble the product for modification. It is recommended to inspect and clean the product regularly to prolong its lifespan.

### Cleaning and maintenance

1. Before cleaning and maintaining this product, be sure to unplug the plug and clean it after the electrical unit is completely cooled.
2. Do not use chemical solvents such as toluene, bleach, and hard brush to avoid scratching and corroding the appearance and color of the body. If there are stubborn dust or dirt, it is recommended to use neutral tableware detergent to clean it.
3. When cleaning the body, please wipe it with a soft cloth dipped with neutral detergent, and then wipe the residual detergent off with a dry cloth.

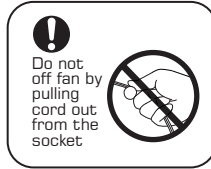

### Disassembly & assembly method

1. Disassembly of the front mesh: unscrew the fixing screws of the mesh cover with a screwdriver; Then press the front net fixing buckle by hand until it is loose, and remove the front net. (as shown in Figure 1)
2. Please unscrew the fixed cap clockwise or rotate the fan blade counterclockwise to remove the fixed cap and gently take out the fan blade by hand along the axial direction. (as shown in Figure 2)
3. The front net and fan blade can be cleaned with water and dried. (as shown in Figure 3).
4. The fuselage can be wiped and cleaned with neutral detergent and soft cloth.
5. After cleaning, assemble the front mesh and fan blade in the reverse direction of disassembly.

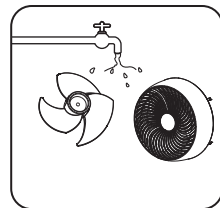
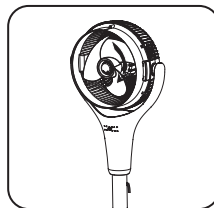
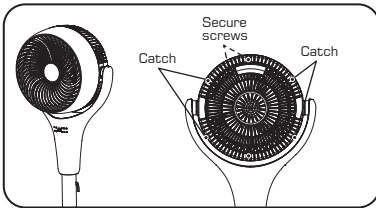

# Composition of Hazardous Substances

Part Name	Hazardous Substances					
	Pb	Hg	Cd	Cr(VI)	PBB	PBDE
PCB	χ	o	o	o	o	o
Motor	χ	o	o	o	o	o
Plastic parts	o	o	o	o	o	o
Power cord	o	o	o	o	o	o
Package	o	o	o	o	o	o
Hardware	o	o	o	o	o	o

This form is prepared in accordance to SJ / T 11364

O: Indicates that the content of the hazardous substance in all homogeneous materials of the component is below the limit specified in GB / T 26572.

X: Indicates that the content of the hazardous substance in at least one homogeneous material of the component exceeds the limit specified in GB / T 26572. However, with the existing technical conditions, it is extremely difficult to make the product parts completely free of the above harmful substances. The design will be gradually improved with the progress of technology.

**10** The "environmental protection service life" of this product is 10 years, and its logo is shown in the left figure. It can only be used under the normal conditions described in this manual.

## ⚠️ WARRANTY COVERAGE ⚠️

1. The warranty period of the product is tied to the purchase date at the corresponding sales platform. If the warranty shown is inconsistent with the model, name or date of the actual product, the warranty will be void.
2. When the product is used in a commercial setting, the warranty duration shall be reduced by half.
3. The accessories and consumable parts of this product are not covered by warranty (such as remote control, packaging materials, user manual).
4. In case of any of the following circumstances, no free preferential treatment will be given during the warranty period.
  - (1) Failure or damage caused by natural or man-made disasters.
  - (2) Failure or damage caused by the relocation or moving of the unit.
  - (3) External factors causing the failure, such as failure or damage caused by external forces during outdoor activities.
  - (4) Damage or misuse of the goods due to malfunction or misuse.
  - (5) Failure or damage caused by unauthorized modification of goods or maintenance by personnels not affiliated to the company.