



Aluminium Extrusion Company

---

Visit Store

# Aluminium Extrusion Company

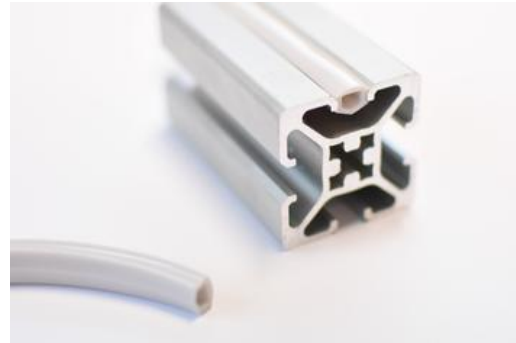

20 Series Slot Cover

\$ 2.00

[Buy Now](#)

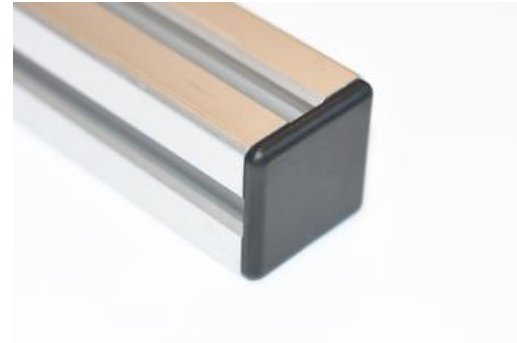

20 series 20x20 End Caps

\$ 0.65

[Buy Now](#)

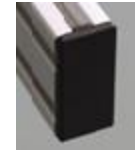

20 Series 20x40 End Caps

\$ 0.75

[Buy Now](#)

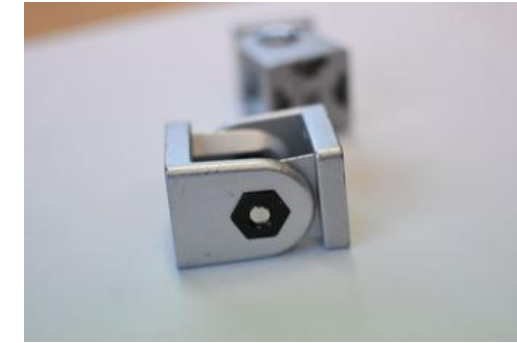

20 Series brackets -adjustable angle

\$ 6.50

[Buy Now](#)



20 series Corner Bracket 3 way

\$ 3.95

[Buy Now](#)



20 series Corner brackets -  
Concealed

\$ 1.20

[Buy Now](#)



20 Series Cube Corner Connector

\$ 3.50

[Buy Now](#)

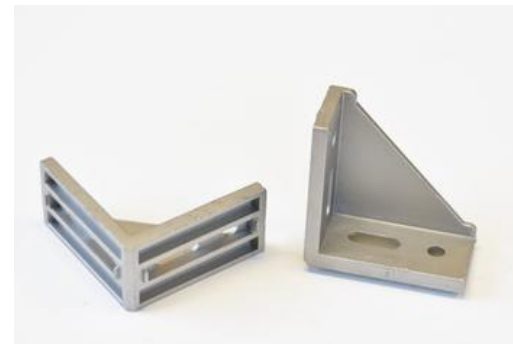

20 series Heavy Duty Corner Bracket

\$ 1.70

[Buy Now](#)



20 series Joiner bar

\$ 2.95

[Buy Now](#)



20 series Standard Corner Bracket

\$ 0.80

[Buy Now](#)

# Aluminium Extrusion Company



20 Series T bolt

\$ 0.40

[Buy Now](#)



20 Series T slot Nut Plate

\$ 0.35

[Buy Now](#)



20 series T Slot Spring Nuts

\$ 0.35

[Buy Now](#)



20x20 Aluminium V slot Extrusion

\$ 10.00

[Buy Now](#)



20x40 Aluminium V slot Extrusion

\$ 13.00

[Buy Now](#)



40 Series Joiner bar

\$ 3.95

[Buy Now](#)



40 series brackets adjustable angle

\$ 7.00

[Buy Now](#)

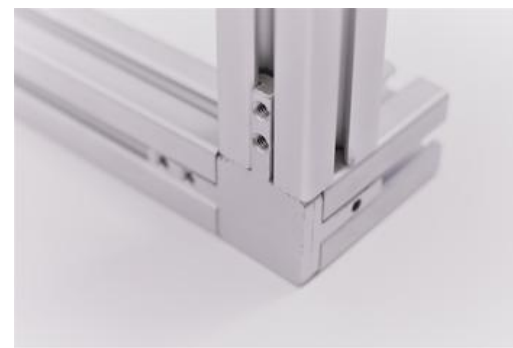

40 Series Corner Bracket 3 way

\$ 9.00

[Buy Now](#)

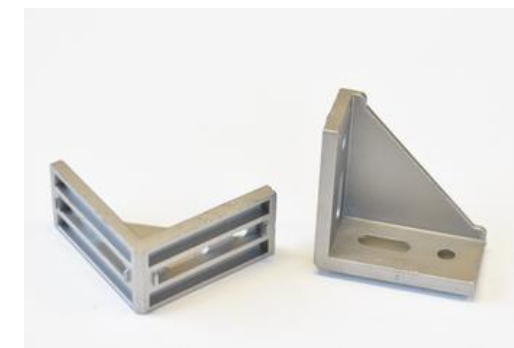

40 series Corner Bracket, Heavy Duty

\$ 4.20

[Buy Now](#)



40 Series Cube Corner Connector

\$ 6.10

[Buy Now](#)

# Aluminium Extrusion Company

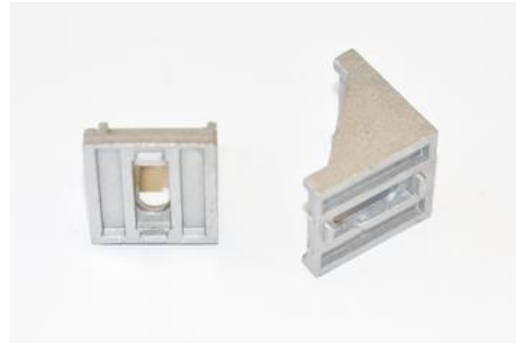

40 series Standard Corner Bracket

\$ 3.00

Buy Now



40 Series T bolt

\$ 0.60

Buy Now

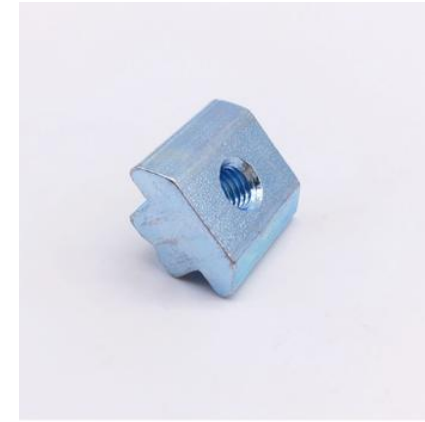

40 Series T slot Nut Plate

\$ 0.60

Buy Now



40 series T Slot Spring Nuts

\$ 0.75

Buy Now

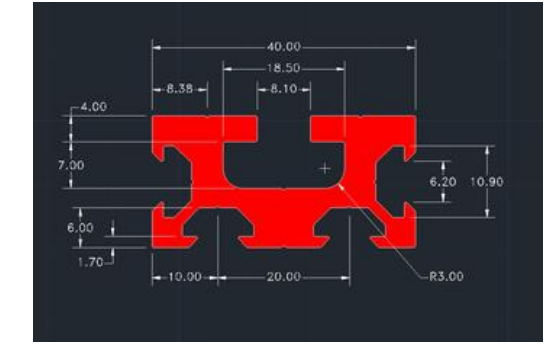

40 x 20 Machine bed Extrusion

\$ 9.60

Buy Now



40x40 Aluminium Extrusion

\$ 8.00

Buy Now



40x40 Corner brackets -Concealed

\$ 3.50

Buy Now

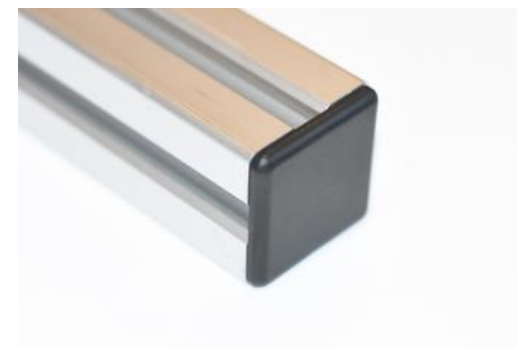

40x40 End Caps

\$ 0.65

Buy Now

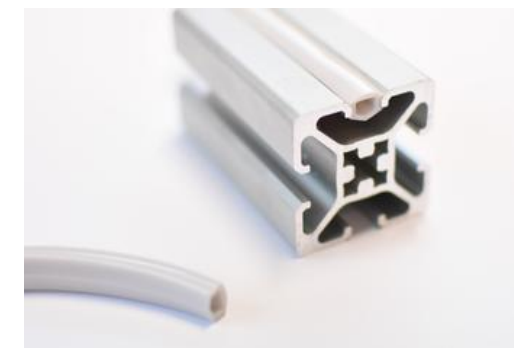

40x40 Slot Cover

\$ 3.95

Buy Now

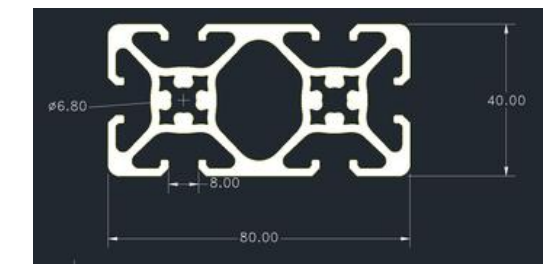

40x80 Aluminum Extrusion

\$ 39.00

Buy Now

# Aluminium Extrusion Company



Adjustable Foot

\$ 8.00

Buy Now



Cap Screws

\$ 0.40

Buy Now



Custom Order

\$ 1.00

Buy Now



Hinge Large -For 40 Series

\$ 3.20

Buy Now



Hinge Large Aluminium -For 40 Series

\$ 6.20

Buy Now



Machine Grade T Slot Nuts

\$ 1.25

Buy Now

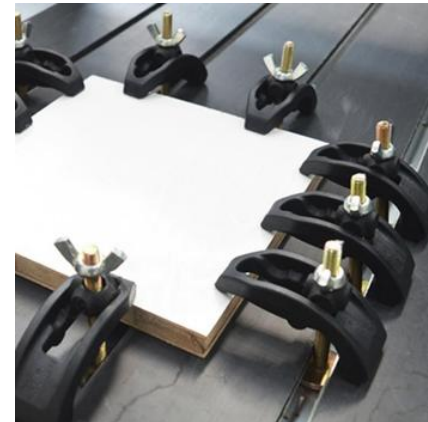

Machine Work Clamp

\$ 7.00

Buy Now



Sample Kit

\$ 5.00

Buy Now