



pitley

PH4
PRODUCT GUIDE



User manual contents:

User manual contents:.....	2
Infrared heating.....	3
Safety information	4
Description and accessories.....	7
Installation.....	8
Commissioning	11
Cleaning, maintenance and service.....	13
Technical information.....	15

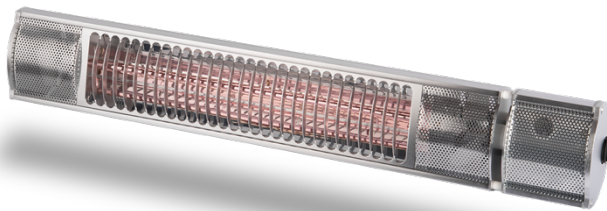



Infrared heating

All Pitley heaters uses the latest infrared technology for optimal comfort, just like being outside in the sun.

This infrared heater does not need air or another medium to transfer energy heat. This means that you will feel 100% heat from the patio heater even if outside conditions are windy

Features on the PH4 heater:

1. Multiple control options - control the heater using the included remote control or on the heater itself
2. Heaters are water resistant thanks to the IP65 standard (total dust and spray water protection)
3. High-quality 1500W Ultra Low Glare heating unit for perfect heating, minimized brightness (glow) and longer product life



Safety information

Please read the user manual carefully and store the manual where it can be accessed by all users.

IMPORTANT SAFETY INFORMATION

Below, we have summarised the most important safety information to prevent any possible risks, such as injuries, fire or electric shocks when handling electrical heaters. Please read this information carefully before commissioning the heater. Always observe the following safety information:

- Ensure that flammable objects, such as chairs, tents, tarpaulins and curtains are at least 1 metre away from the heater and cannot be blown into contact with the heater by the wind, as the heater generates a high level of heat.
- Do not cover the heater with a blanket or other flammable objects.
- The heater is designed to be installed on walls, eaves or ceilings at a height of 180 cm. above the floor.
- Although the heater is IP65 class protected, please handle water carefully. Ensure that you do not touch the heater with wet hands. The heater must not be placed in close proximity to swimming pools, baths or showers, and must not be operated directly from these places. It must be positioned so that it cannot fall into baths, showers, containers full of liquids, etc.



- Heaters must not be within reach nor accessible to children and/or disabled persons. Children and/or disabled persons must always be supervised when near heaters. The same applies to pets.
- Both the front and the heater chassis will become very hot when operated.
- Never directly touch the heater during operation, and allow it to cool down before touching it. Disregarding this safety information may result in burns and injuries.
- Never touch the plug with wet hands and ensure that the socket is clean and free of dust.
- When plugging the heater on and off, always make sure to plug in or out by pulling by the plug and not pulling by the cable.
- When cleaning, repositioning, maintaining or installing the heater, turn off the heater completely and always unplug it from the socket.
- Never insert any objects or your fingers into the heater openings.
- Never operate the heater near flammable liquids or other flammable and highly combustible materials such as paints, e.g. lacquers, petrol, gas pipes, gas tanks or spray cans.
- Check the power cable and plug regularly to ensure they are in good condition.
- Look for any possible damage to the heater. This is particularly important if the heater has fallen down or has been damaged in any other way. If you notice any faults or damage to the chassis, bars, cables or plug, switch the heater off immediately and



disconnect it from the power supply. There is a serious risk of injury, fire and other damage.

- Do not leave the heater unattended when it is switched on. Ensure that the heater cannot be switched on by automatic timers and similar devices if it is unattended.
- Only use the heater for its intended purpose, as described in this user manual. Deviating from this user manual may result in damage or injuries to people, animals and objects. This automatically results in the warranty being voided, and dealers, manufactures and/or importers shall not assume any liability.



Description and accessories

The Pitley PH4 comes with a remote control, and can be installed in a variety of ways.

Pitley infrared heater:

1. Initial heating bracket to fit installation bracket
2. On/Off switch
3. Power-on LED

Accessories:

1. Wall-, ceiling, eaves installation bracket
2. Screws with metal dowels for wall installation
3. 2 wing screws and nuts
4. Allen key for positioning the main screw for the installation brackets
5. Remote control

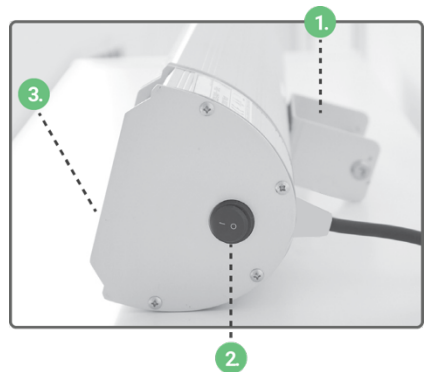



Installation

Step 1)

Remove the heater from its packaging and remove any packaging materials from the heater and accessories. It is particularly important to remove the foam strips that protect the bars during transport. Carefully pull these strips away from the heater in the direction of the arrow. If you have tested the heater function before installing it, allow it to cool before installing it.

Step 2)

Next, carefully choose where you want to install the heater.

The heater can be installed under the following circumstances:

- On the wall using the wall/ceiling bracket
- On the ceiling using the wall/ceiling bracket
- To the eaves of the house using wall/ceiling bracket

Step 3)

Depending on the installation method chosen (wall, ceiling, brick, etc.), select the right installation bracket.

Step 4)

Using the Allen key, undo the long screw on the bracket at the back of the heater and insert the chosen installation bracket. Then tighten the long screw using the Allen key so that the installation bracket is secured correctly. You can also use this screw later to adjust the angle of the heater once it has been installed on the wall or ceiling.



Step 5)

Position the heater where it is to be installed and mark the drill holes where the installation bracket will later be screwed to the wall, ceiling or eaves. Then secure the installation bracket to the wall, ceiling or eaves using the screws and metal dowels supplied. Then screw the heater back on the installation bracket. The heater is now hanging securely on the wall or ceiling.

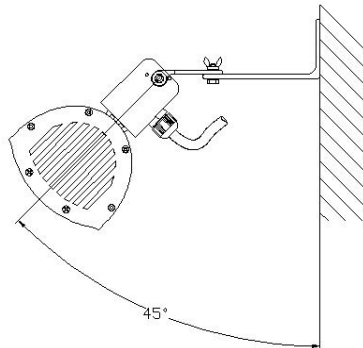

Step 6)

Now use the Allen key to adjust the bracket screw on the back of the heater to set the desired angle for the heater. When angle is chosen, make sure that no flammable objects are in the proximity of the chosen angle. Then tighten the screws.

Step 7)

Ensure that the power cable is always directed away from the heater and is not wound around the heater. This may cause a fire if the cable heats up by coming into direct contact with the heater and



heating area. It must also be checked that the heater is only plugged into sockets that are protected by statutory fuses and groundings.

Under certain circumstances, it may be beneficial to install the heater permanently – route the cable securely and connect it directly to the power source so that it can be operated using a wall switch. When doing so, the heater must only be installed by a qualified electrician who can guarantee installation and correct conditions.

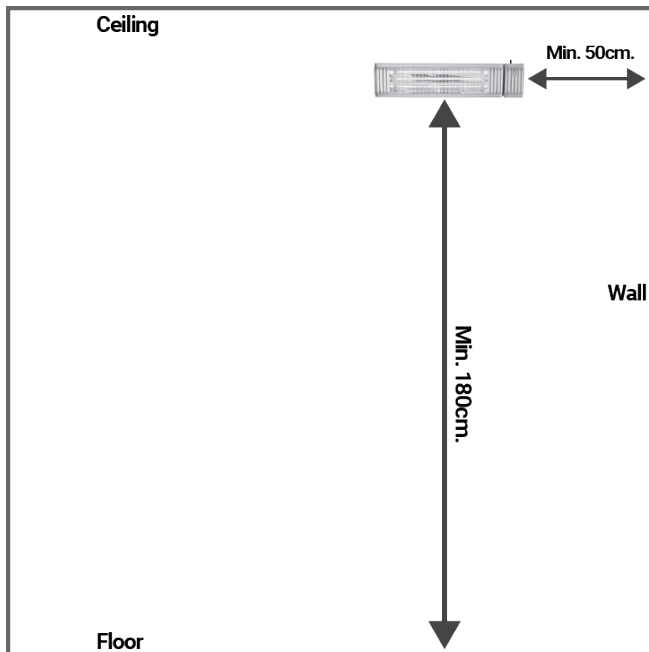



Commissioning

After switching the heater on using the On/off switch you can control the heater using the remote control.

Operation using the remote control:

1. Insert two AAA 1.5V batteries in the remote control. When using the infrared remote control, always point it directly at the heater as it does not work if there are any obstacles between the remote control and the heater.
2. Plug the heater into the socket
3. Then press the On/Off switch (3.) on the side of the heater. The switch must be in the "I" position. The blue LED (7.)
4. Switching on: Now press the "On" button on the remote control to switch on the heater. The heater first switches on at 33%, "Gentle start". After 4 seconds, it returns to the heating setting that was last selected. When the heater is used for the first time, it switches to the maximum setting after 4 seconds. The LED that was previously blue is now red (7.).
5. Dimming: Using the arrow keys, you can dim the heater to increase and decrease the intensity. Alternatively, the heater can also be dimmed by pressing the reset button directly.
6. Switching off: Use the "Off" button to switch the heater off again. The LED display switches from red back to blue. Then switch the "On/off switch" to "0" to switch the heater off







completely. For safety, we also recommend unplugging the heater.

Caution:

If you switch the heater off using the remote control, the heater enters standby mode and is easy enabled again.



Up arrow		Heating level up
Down arrow		Heating level down
Max level		Heater goes to maximum heating level
Turn heater on		Heater turns on. Soft 4 second start.
Turn heater off		Heater turns off and go to standby mode.



Cleaning, maintenance and service

Cleaning

The Pitley heater has been designed so that the robust chassis does not require any maintenance. Switch off and unplug the heater before cleaning it.

Only clean it when it is cool. When cleaning, use a microfibre cloth and avoid using aggressive cleaning agents, scouring sponges or stiff brushes. Do not use any flammable cleaning agents. Once you have cleaned the heater, allow it to dry before switching it on again.

Maintenance

In general, the heater does not require any maintenance. As the heater has been sealed as per IP65, it must not be opened by unauthorised persons. If there seems to be a problem, contact your dealer.

Service and repair

If you notice any damage or a fault with your heater, it must be checked and repaired by a specialist. This may be a qualified electrician or your dealer. Damage or defects arising from unauthorised repairs, as well as modifications to the heater, misuse, negligence, and improper or inadequate maintenance will be voided warranty. Dealers and the manufacturer shall not be liable for misuse or improper handling.



Disposal

The heater must not be disposed of together with your normal household waste. Please take the heater to your local recycling centre to dispose of it.

Electrical information

Before commissioning, please ensure that you are using slow-blow fuses for the Pitley electrical circuit. Please ask your electrician if you have any questions.



Technical information

Type:	Pitley Infrared Heater
Chassis Material:	Aluminium
Work locations:	Perfect for indoor and outdoor
Heat area:	indoor up to 25m ² and outdoor 6-12m ²
Protection class:	IP65, dust, rain, waterproof
Operation:	Buttons on heater and remote control
Infrared element:	Ultra-Low-Glare heater
Output:	0 - 1500W
Special functions:	Soft start. Overheating protection
Mounting system:	Wall/ceiling/eaves mounting + anchors, screws
Voltage:	220-240V ~ 50 Hz
Dimensions	(LxWxH): 63cm x 10cm x 7,7cm
Weight:	3,5 Kg
Pivoting range:	100°, vertical
Beam Angle:	Approx. 40° concentrate beam
Remote range:	Up to 6 m
Batteries remote:	2 x AAA batteries (included)



Pitley Europe

Nistedvej 21
DK-5270 Odense N
DENMARK

support@pitley.com

www.pitley.com