

# WM700EW



## Wall Mount Barbecue



### Features and Benefits:

Warranty	2 Years
Compact & Space Saving	Perfect for inner city and apartment living due to space saving shelves which can fold away allowing you to maximise your outdoor space.
Easy to Keep Clean	Easy to clean ceramic glass grill surface.
304 Grade Stainless Steel	High quality 304 grade stainless steel which is extremely resistant to heat, rust and weather.
Simple Installation	Easy to install and configure design.
Drip System for Healthier Cooking	Drip system allows for unhealthy fats and oils to drain through a channel and into an easy to dispose of drainage area.
10 Amp Power Required	Standard power output required to supply sufficient electricity to barbecue.
MADE IN ITALY	Units are designed specifically for the Australian market and manufactured in Italy by dedicated boutique specialist manufacturer.

Note: Gas model variation to be made available in 2016

**Distributed by Arisit Pty Ltd**

40-44 Mark Anthony Drive, Dandenong South VIC 3175 Phone: 1300 762 219 Fax: 03 9706 6904 Website: [www.arisit.com](http://www.arisit.com)

# WM700EW



## Wall Mount Barbecue

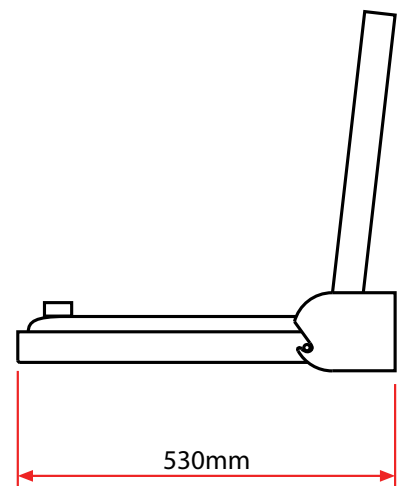
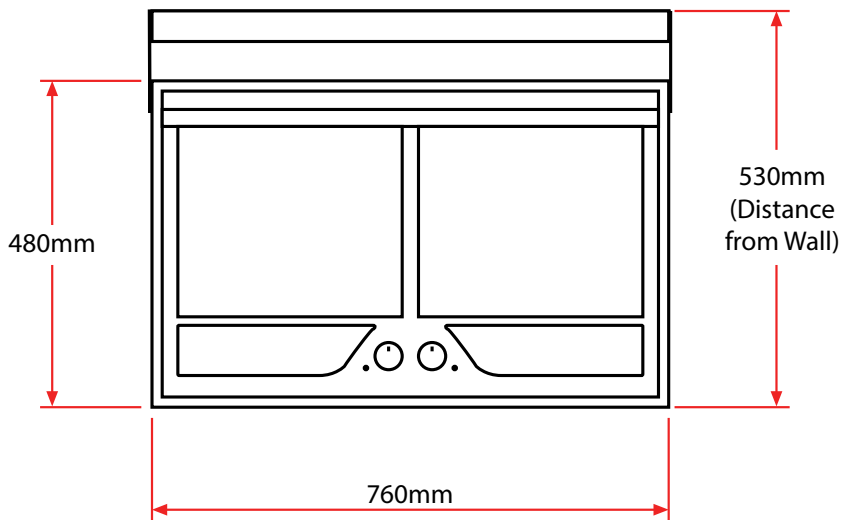
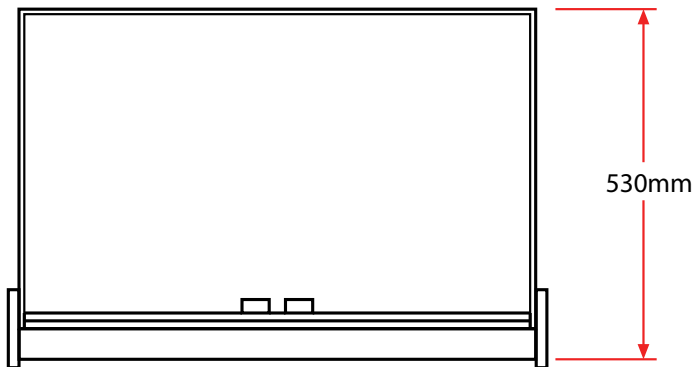

Model	WM700EW
Control Panel	Stainless Steel
Total Amps	10 AMPS
Total Power (Voltage)	240V
Nature of Power Supply	A.C.
Product Dimensions (Lid Open)	(W) 775mm x (D) 530mm x (H) 530mm
Product Dimensions (Folded Away)	(W) 775mm x (D) 150mm x (H) 525mm

**WARNING:** Technical specifications and product sizes can be varied by the manufacturer, without notice. Cut outs for appliances should only be physical product measurements. The above information is indicative only.

**Distributed by Arisit Pty Ltd**

40-44 Mark Anthony Drive, Dandenong South VIC 3175 Phone: 1300 762 219 Fax: 03 9706 6904 Website: [www.arisit.com](http://www.arisit.com)