

PRO36RBI N/L

36" Built In Open Grill BBQ with Solid Flat Plate



Features and Benefits:

Warranty	2 Years
Quality Handcrafted Stainless Steel Product	Stainless steel rods for flame grilling
3 x Precision Burners	Stainless steel precision burners with flame failure.
Flame Failure	Flame failure is designed for the highest levels of safety.
Thermostat in hood	Hood-mounted thermostat allows for accurate temperature reading
Stainless Steel Solid Plate	Stainless Steel teppanyaki grill plate included as standard.
Electronic Ignition (AA Batteries)	Designed for reliable ignition of flame.
Amperage Requirement	10 AMP GPO required for rotisserie
Gas Type	Choice of Natural or LPG
Handcrafted with Precision in California, U.S.A.	Units are designed and manufactured in California, U.S.A. by dedicated boutique specialist manufacturer.

Distributed by Arisit Pty Ltd

40-50 Mark Anthony Drive, Dandenong South VIC 3175 Phone: 1300 762 219 Fax: 03 9706 6904 Website: www.arisit.com

PRO32RBI N/L

32" Built In Open Grill BBQ with Solid Flat Plate

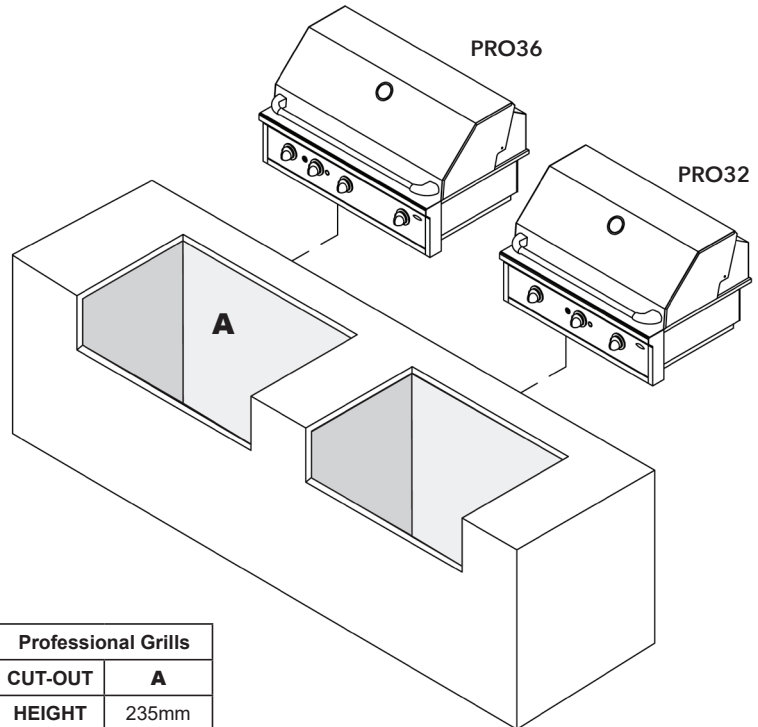
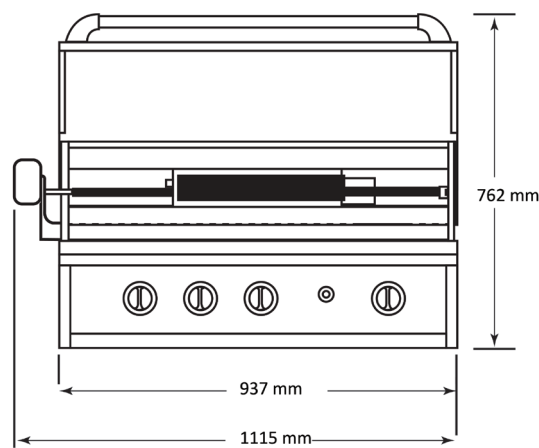
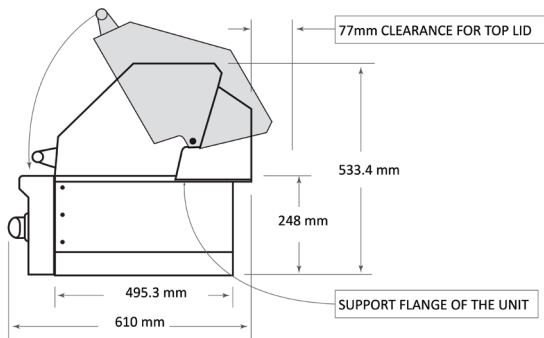

Professional Grills	
CUT-OUT	A
HEIGHT	235mm
WIDTH	902mm
DEPTH	489mm

* Floor base 272mm min. from bottom of benchtop.
 A minimum 50mm clearance is required directly below the barbecue.

Model	PRO36RBI N/L
Control Panel	Chrome Plated knobs; Steel Bevel
Gas Type	Available in Both Natural Gas & LPG (must be ordered to suit gas)
Total Mj Consumption	78.51 Mj/hr (NG) 77.22 Mj/hr (LPG)
LPG Gas Bottle Requirement	9kg Gas Bottle
Product Dimensions	(W) 937mm (without rotisserie) x (D) 732mm x (H) 762mm (lid open)
Cut Out Product Dimensions	(W) 902mm x (D) 489mm x (H) 235mm

WARNING: Technical specifications and product sizes can be varied by the manufacturer, without notice. Cut outs for appliances should only be physical product measurements. The above information is indicative only.

Distributed by Arisit Pty Ltd

40-50 Mark Anthony Drive, Dandenong South VIC 3175 Phone: 1300 762 219 Fax: 03 9706 6904 Website: www.arisit.com