



SPARE - PARTS CATALOG

POLARIS
RANGER 800 XP

HardCabs →

CAB PREVIEW

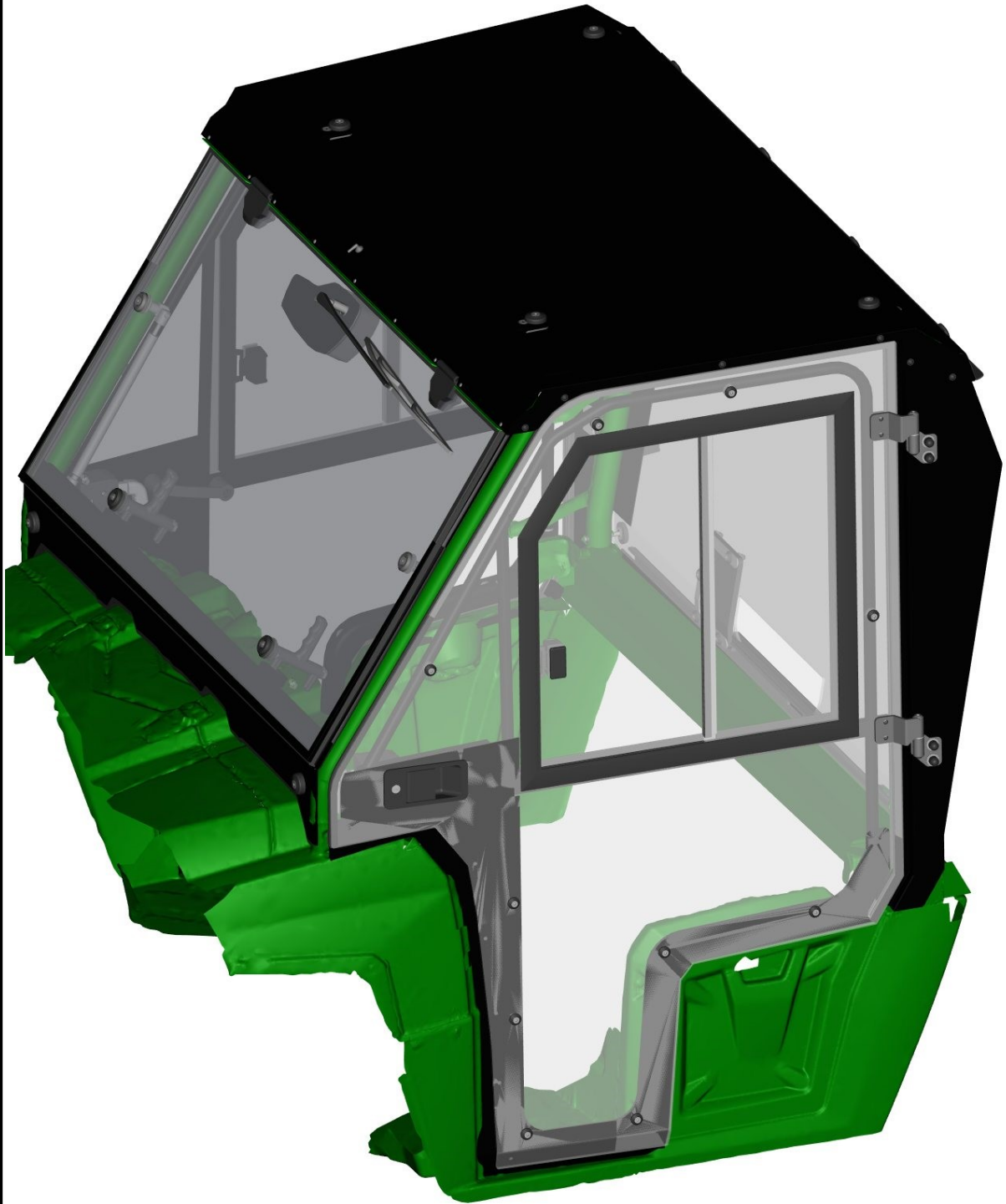

2

FOR ALL TECHNICAL QUESTIONS, PLEASE CALL
DFK AMERICA INC.
(630) 324-8585



3

ID	Catalogue no.	Description	Qty
1	32S01U05S30	ROOF	1
2	32S01U02S20	REAR PANEL	1
3	32S01U02S40	LEFT DOOR	1
4	32S03U02S10	FRONT PANEL	1
5	32S01U02S50	RIGHT DOOR	1

FOR ALL TECHNICAL QUESTIONS, PLEASE CALL
DFK AMERICA INC.
(630) 324-8585

FRONT PANEL

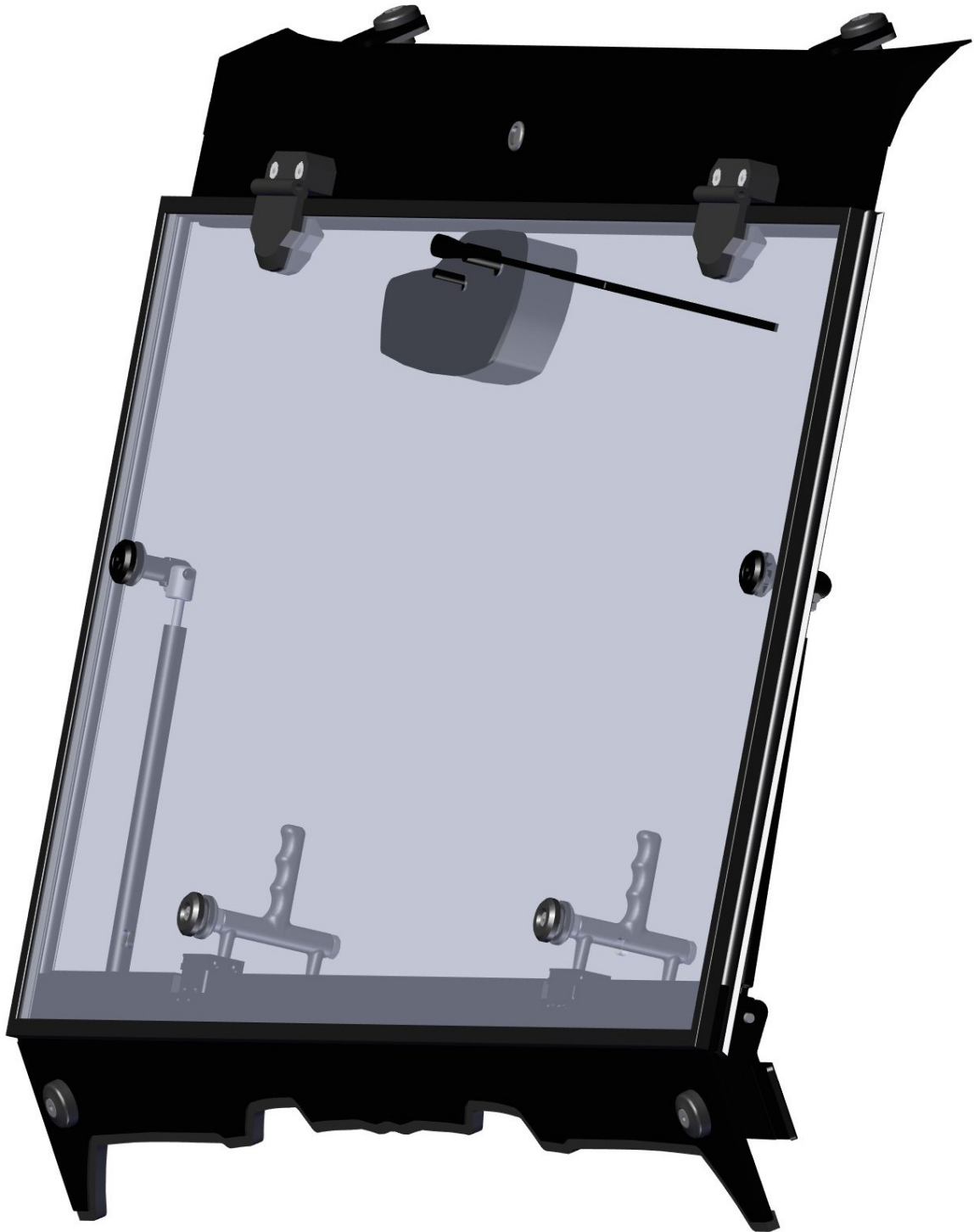

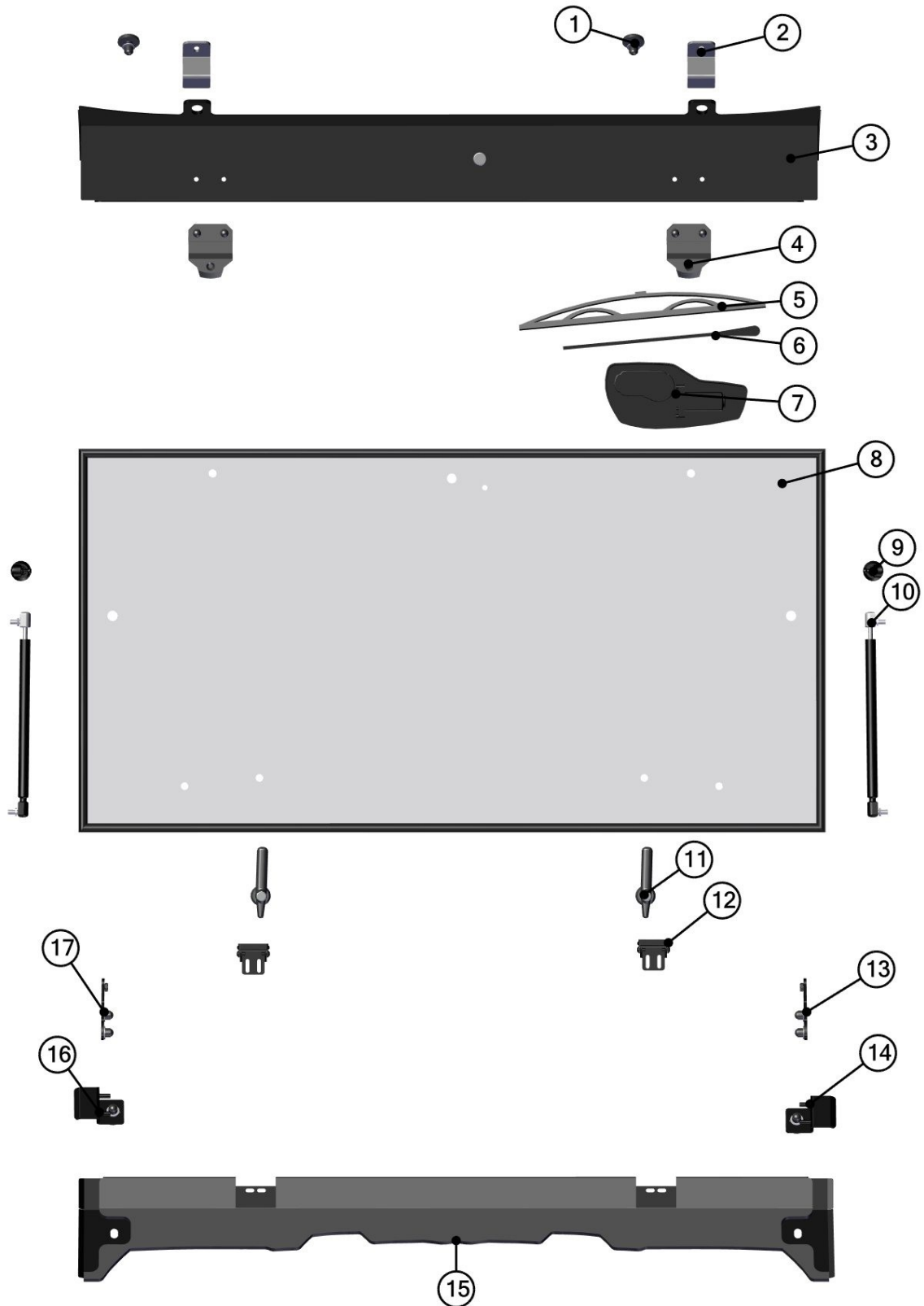

5

FOR ALL TECHNICAL QUESTIONS, PLEASE CALL
DFK AMERICA INC.
(630) 324-8585



ID	Catalogue no.	Description	Qty
1	00-10M002	FIXING ASSEMBLY	2
2	32S03U02-10-010	FRONT UPPER LEDGE HOLDER	2
3	32S03U02-10W002	FRONT UPPER LEDGE WELDED	1
4	00-10M012	FRONT HINGE ASSEMBLY	2
5	000798	WIPER LATH	1
6	001764	WIPER ARM	1
7	001763	WIPER MOTOR 12V	1
8	32S03U02-10M002	FRONT GLASS WITH SEAL	1
9	001693	GAS SPRIGN HOLDER	2
10	002494	GAS SPRING	2
11	00-10M023	FRONT GLASS LOCK ASSEMBLY	2
12	32S03U02-10M007	FRONT GLASS STOP ASSEMBLY	2
13	32S03U02-10W003	RIGHT GAS SPRING HOLDER WELDED	1
14	32S01U02-10M010	RIGHT FRONT BOTTOM LEDGE HOLDER ASSEMBLY	1
15	32S03U02-10M001	FRONT BOTTOM LEDGE ASSEMBLY	1
16	32S01U02-10M009	LEFT FRONT BOTTOM LEDGE HODLER ASSEMBLY	1
17	32S03U02-10W004	LEFT GAS SPRING HOLDER WELDED	1

REAR PANEL



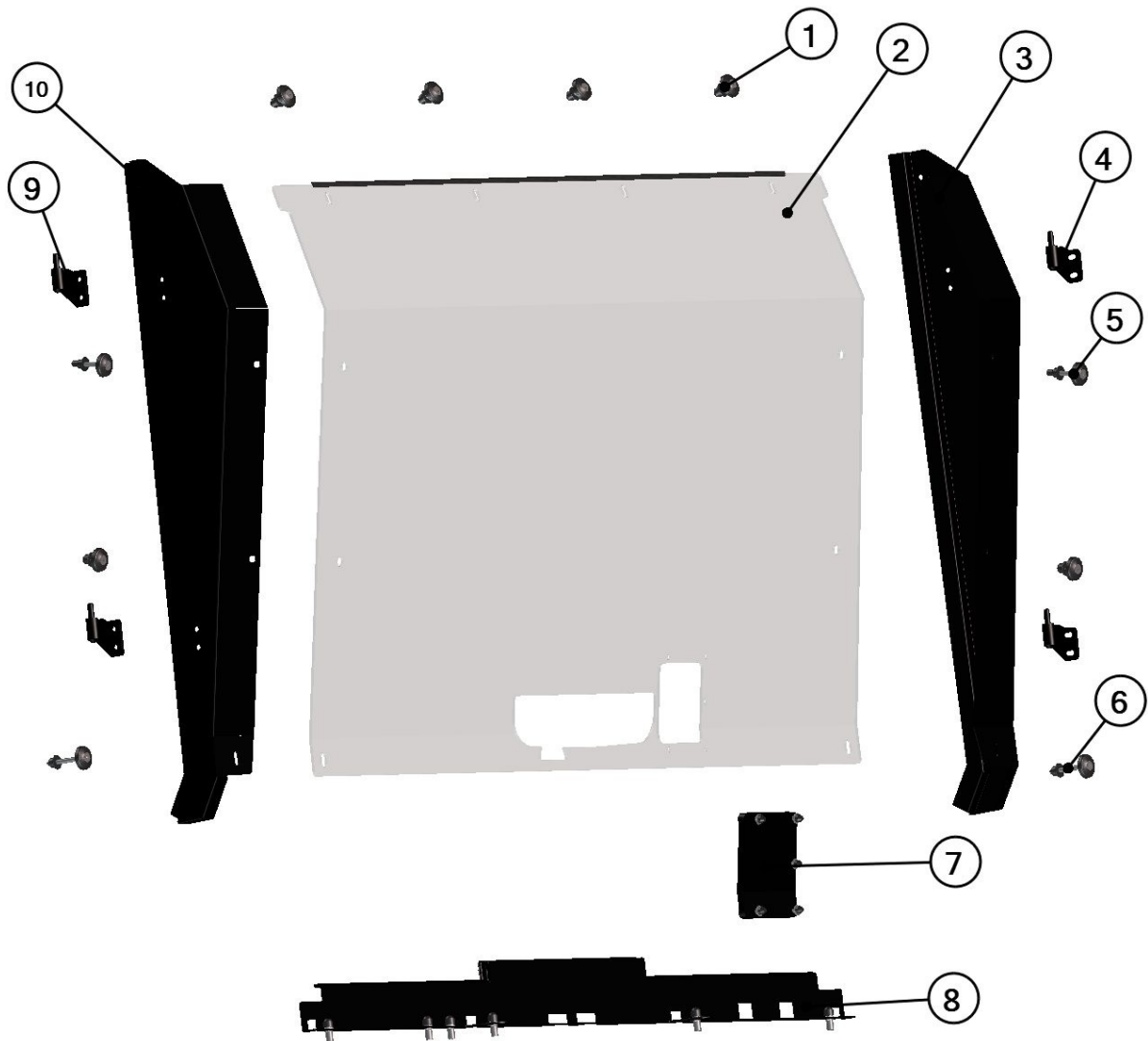

8

Id	Catalogue no.	Description	Qty
1	32S01U02-30M004	FIXING ASSEMBLY	6
2	32S01U02-20-003	REAR POLYCARBONATE	1
3	32S01U02-20W002	RIGHT DOOR BASE WELDED	1
4	32S01U02-50W003	RIGHT BASE HINGE	2
5	32S01U02-20M002	REAR FIXING ASSEMBLY 1	2
6	32S01U02-20M003	REAR FIXING ASSEMBLY 2	2
7	32S01U02-20M006	REAR SEALING ASSEMBLY	1
8	32S01U02-20M001	REAR BOTTOM LEDGE	1
9	32S01U02-40W003	LEFT BASE HINGE	2
10	32S01U02-20W001	LEFT DOOR BASE WELDED	1

ROOF PANEL



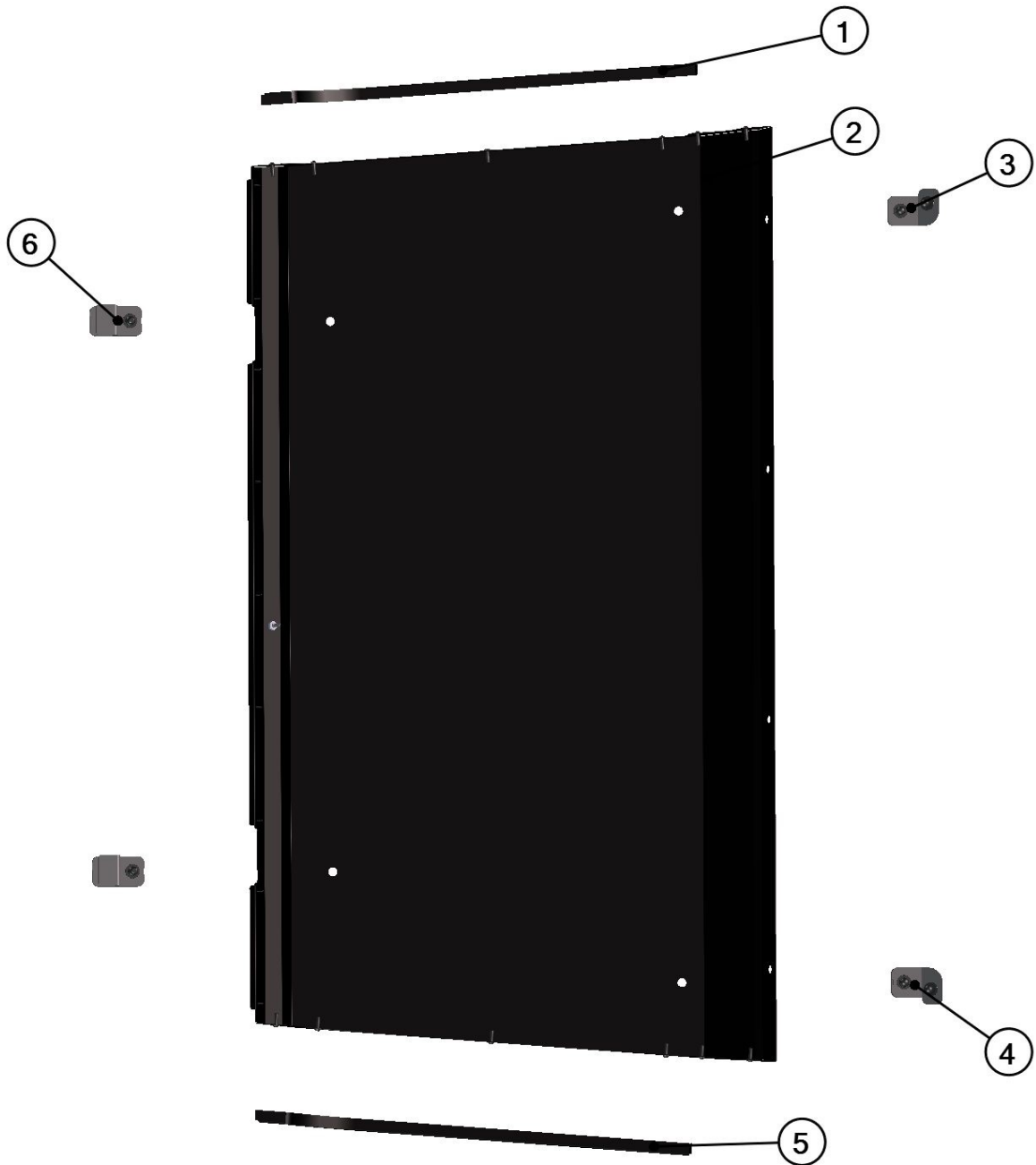

10

Id	Catalogue no.	Description	Qty
1	32S01U02-30W001	LEFT ROOF LEDGE WELDED	1
2	32S01U02-30-001	ROOF PANEL	1
3	32S01U02-30M002	LEFT REAR ROOF HOLDER ASSEMBLY	1
4	32S01U02-30M003	RIGHT REAR ROOF HOLDER ASSEMBLY	1
5	32S01U02-30W004	RIGHT ROOF LEDGE WELDED	1
6	32S01U05-30M001	FRONT ROOF HOLDER ASSEMBLY	2

FOR ALL TECHNICAL QUESTIONS, PLEASE CALL
DFK AMERICA INC.
(630) 324-8585

DOOR LEFT+DOOR RIGHT



11

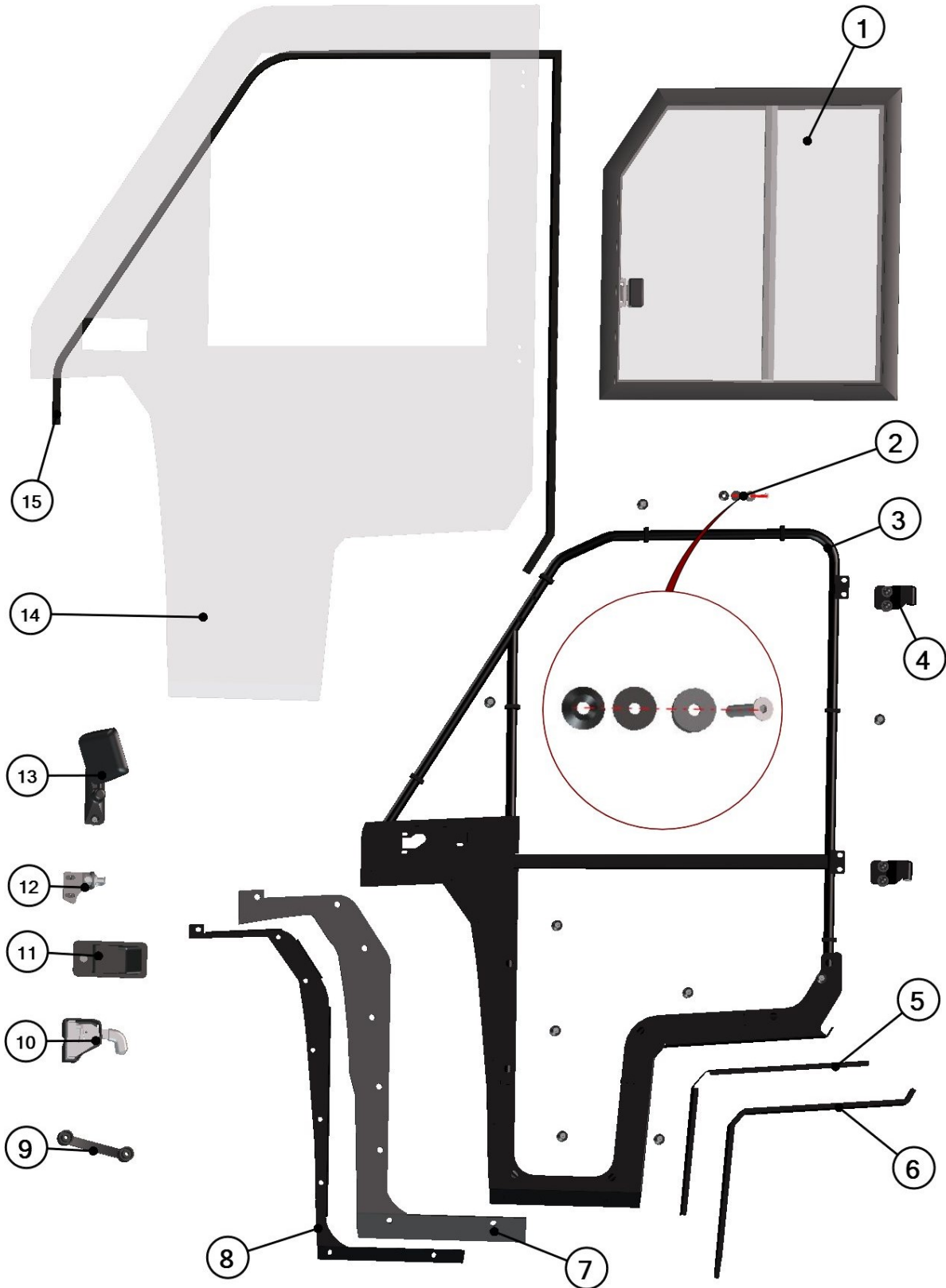

FOR ALL TECHNICAL QUESTIONS, PLEASE CALL
DFK AMERICA INC.
(630) 324-8585



LEFT DOOR TABLE

Id	Catalogue no.	Description	Qty
1	32S01U02-40M001	LEFT WINDOW ASSEMBLY	1
2	00-40M001	POLYCARBONATE FIXING ASSEMBLY	10
3	32S01U02-40W001	LEFT DOOR FRAME WELDED	1
4	00-105U-W006	LEFT DOOR HINGE	2
5	32S01U02-40-027	LEFT DOOR SEALING LEDGE 2	1
6	32S01U02-40-025	LEFT DOOR SEALING EPDM 2	1
7	32S01U02-50-004	DOOR SEALING EPDM	1
8	32S01U02-40-018	LEFT DOOR SEALING LEDGE 1	1
9	00-40M018	DOOR HANDLE ASSEMBLY	1
10	00-40M019	LEFT INNER DOOR LOCK	1
11	000841	OUTER DOOR LOCK	1
12	32S03U01-40M005	LEFT DOOR STOP ASSEMBLY	1
13	00-109U-M001	LEFT DOOR MIRROR	1
14	32S01U02-40-005	LEFT DOOR POLYCARBONATE	1
15	32S01U02-40-035	RUBBER PROFILE "SARAZIN SIDE"	1

RIGHT DOOR TABLE

Id	Catalogue no.	Description	Qty
1	32S01U02-50M001	RIGHT WINDOW ASSEMBLY	1
2	00-40M001	POLYCARBONATE FIXING ASSEMBLY	10
3	32S01U02-50W001	RIGHT DOOR FRAME WELDED	1
4	00-105U-W005	RIGHT DOOR HINGE	2
5	32S01U02-50-027	RIGHT DOOR SEALING LEDGE 2	1
6	32S01U02-50-025	RIGHT DOOR SEALING EPDM 2	1
7	32S01U02-50-004	DOOR SEALING EPDM	1
8	32S01U02-50-018	RIGHT DOOR SEALING LEDGE 1	1
9	00-40M018	DOOR HANDLE ASSEMBLY	1
10	00-50M019	RIGHT INNER DOOR LOCK	1
11	000841	OUTER DOOR LOCK	1
12	32S03U01-50M005	RIGHT DOOR STOP ASSEMBLY	1
13	00-109U-M002	RIGHT DOOR MIRROR	1
14	32S01U02-50-005	RIGHT DOOR POLYCARBONATE	1
15	32S01U02-40-035	RUBBER PROFILE "SARAZIN SIDE"	1

FOR ALL TECHNICAL QUESTIONS, PLEASE CALL

DFK AMERICA INC.

(630) 324-8585

ELECTROINSTALLATION

The cabin can be supplied with 2 different types of heaters – Type “A” and type “B”.

	Catalogue no.	Description	Qti
1A	002344	HEAT 12V „A“	1
1B	002346	HEAT 12V „B“	1
2	000968	SWITCH – WIPER/WASHER/OFF	1
3	001576	WASHER MOTOR	1
4	002875	FUSE BOX	3
5	000885	WASHER COMPLETE	1
6	002764	WIPERMOTOR 12V	1
7	32S01U02-01M001	CABLE HARNESS - WIPER, WASHER	1
8A	32S01U02-02M001	CABLE HARNESS – HEAT „A“	1
8B	32S03U01-02M003	CABLE HARNESS – HEAT „B“	1
9	00-01-001	WASHER COMPLET HOLDER	1
10A	32S01U02-02W001	HEAT HOLDER „A“	1
10B	32S03U01-02M002	HEAT HOLDER „B“	1
11	002502	Y COUPLING	1
12	002524	TIGHTENING STRAP	6
13	002386	ELECTRIC VENT	1
14	002348	SCREW RIVETS	3
15A	32S01U02-02W002	BOTTOM PART OF HEATER HOLDER „A“	1
15B	-----	DOES NOT EXIST „B“	0
16	002391	ELECTRIC VENT SWITCH	1
17	002491	AIR VENT VALVE	1
18	002517	HEATER TUBE (DIESEL)	1
19	32S01U02-02M005	FLANGE (PETROL)	1
20	002495	SEAL FOR FLANGE (PETROL)	1
21	002368	NIPPLE (PETROL)	1

SEE

14

PICTURES ON NEXT PAGES

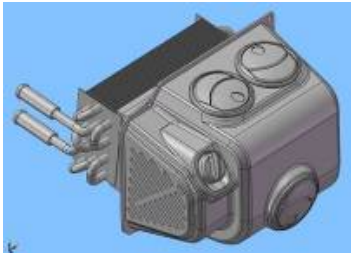

Position : 1A

Catalogue no.: 002344



Position : 1B

Catalogue no.: 002346



Position : 2

Catalogue no.: 000968

Position : 3

Catalogue no.: 001576

Position : 4

Catalogue no.: 002875

Position : 5

Catalogue no.: 000885



Position : 6

Catalogue no.: 002764



Position : 7

Catalogue no.: 32S01U02-01M001



Position : 8A

Catalogue no.: 32S01U02-02M001



Position : 8B

Catalogue no.: 32S03U01-02M003

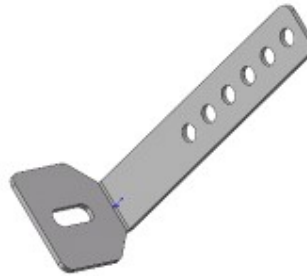

Position : 9

Catalogue no.:00-01-001

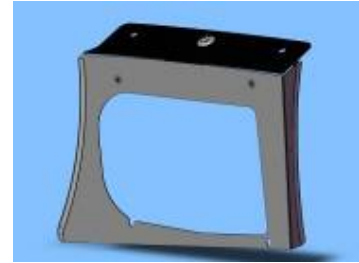

Position : 10A

Catalogue no.: 32S01U02-02W001



Position : 10B

Catalogue no.: 32S03U01-02M002

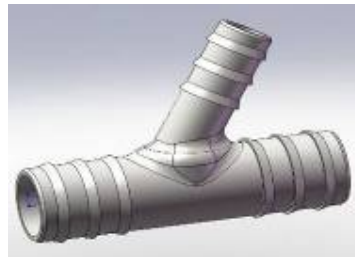

Position : 11

Catalogue no.: 002502



Position : 12

Catalogue no.: 002524



Position : 13

Catalogue no.: 002386



Position : 14

Catalogue no.: 002348

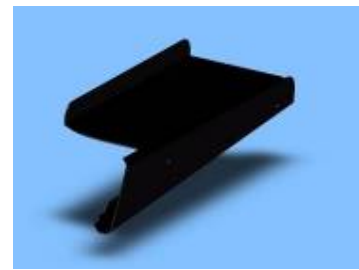

Position : 15A

Catalogue no.: 32S01U02-02W002



Position : 16
Catalogue no.: 002391



Position : 17
Catalogue no.: 002491



Position : 18
Catalogue no.: 002517



Position : 19
Catalogue no.: 32S01U02-02M005



Position : 20
Catalogue no.: 002495



Position : 21
Catalogue no.: 002368