

Item	Description
A	Upper
B	Lower
C	Mount x 2
D	Clamp x 2
E	End Cap x 2
F	Alignment Washer x 2

(kit contents on following pages)

Need help with your installation?

✉ sales@superatv.com 🖥 www.superatv.com

☎ 1-855-743-3427 🕒 8:00am - 9:00pm EST M-Th
 8:00am - 7:00pm EST Friday
 9:00am - 2:00pm EST Saturday

Read instructions and view illustrations before beginning.

Thank You
For Choosing
SUPERATV.COM[®]

(kit contents continued)

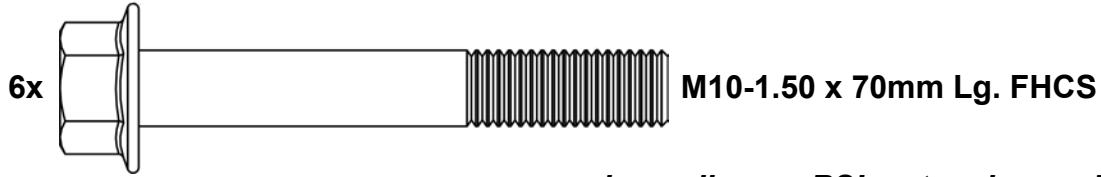
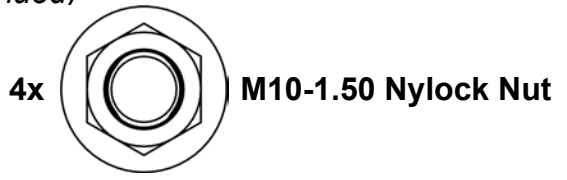

depending on RSL setup, longer bolt may be required

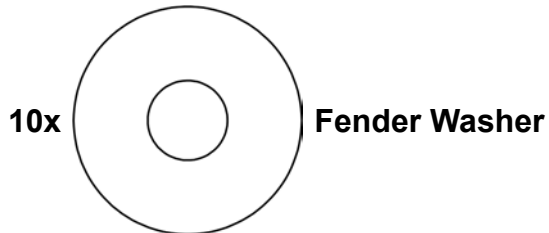
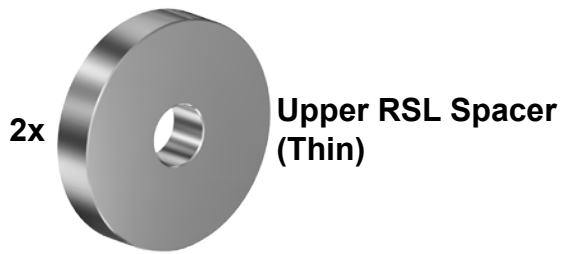
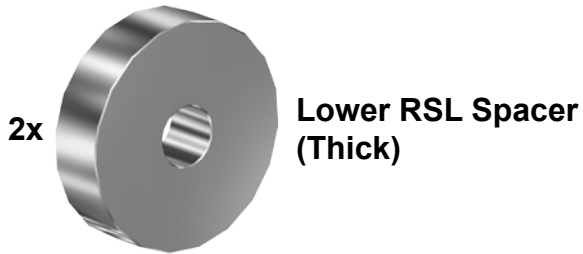
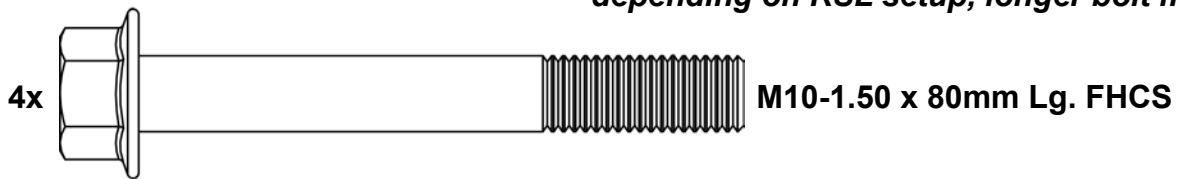

Depending on machine setup, some hardware may not be used.

Use only if all components listed are installed:

- SuperATV Rear Bumper RBG-P-RZR1K-001
- SuperATV Rear Fender Protection FP-P-RZR1K-003
- SuperATV Radius Arms RSL-P-RZR1K-008



2x - Large Lower RSL Spacer

separate Clamps (D) and set aside

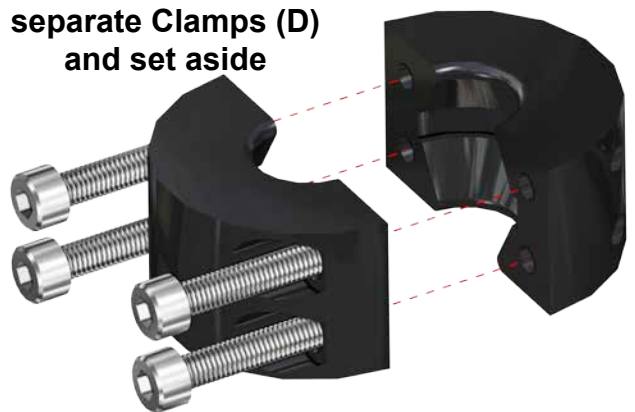

(kit contents continued)

M12 hardware shown will be used for Lower (B) mounting depending on model; see page 8.

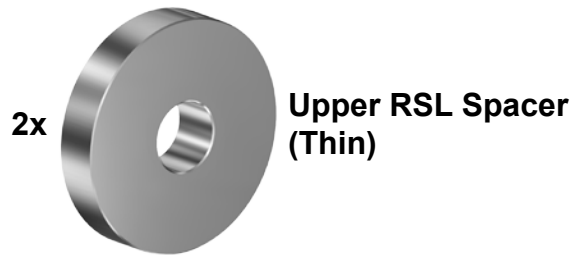
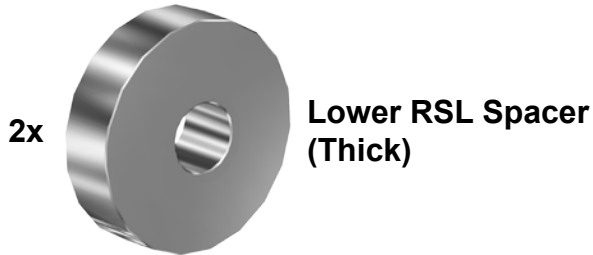
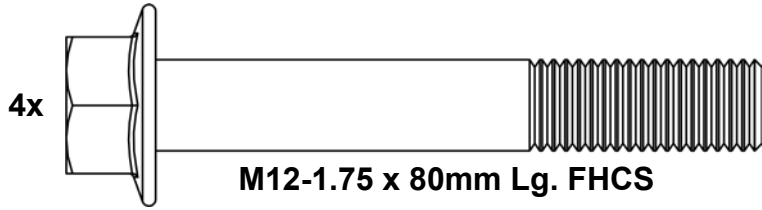

Liability Statement

SuperATV's® products are designed to best fit user's ATV/UTV under stock conditions. Adding, modifying, or fabricating any factory or aftermarket parts will void any warranty provided by SuperATV® and is not recommended. SuperATV's® products could interfere with other aftermarket accessories. If user has aftermarket products on machine, contact SuperATV® to verify that they will work together.

Although SuperATV® has thousands of satisfied customers, user should be aware that installing lift kits, long travel, or suspension kits, tires, etc. will change the ride of machine and may increase maintenance and part wear. Operating any off-road machine while, or after, consuming alcohol and/or drugs increases risk of bodily harm or death. No warranty or representation is made as to this product's ability to protect user from severe injury or death. SuperATV® urges operators and occupants to wear a helmet and appropriate riding gear at all times.

By purchasing and installing SuperATV® products, user agrees that should damages occur, SuperATV® will not be held responsible for loss of time, use, labor fees, replacement parts, or freight charges. SuperATV®, nor any 3rd party, will not be held responsible for any direct, indirect, incidental, special, or consequential damages that result from any product purchased from SuperATV®. The total liability of seller to user for all damages, losses, and causes of action, if any, shall not exceed the total purchase price paid for the product that gave rise to the claim.

SuperATV® will warranty only parts provided by SuperATV®. Any damage or problems with OEM housings, bearings, seals, or other manufacturers' products will not be covered by SuperATV®. SuperATV® parts and products are not warranted if item was not installed properly, misused, or modified.

Installing, adding, modifying, or fabricating any factory or aftermarket product to your ATV/UTV may violate certain local, state, and federal laws. Be advised that laws vary depending on town, city, county, state, etc. Use of certain products on public streets, roads, or highways may be in violation law. The Buyer is solely and exclusively legally and personally responsible for any violation of the law by the installation or use of the product. You must abide by all local, state, and federal laws, including but not limited to vehicle safety, traffic laws, and ordinances. It is your responsibility to know the laws and how they apply to you.

The Buyer is responsible to fully understand the capability and limitations of his/her vehicle according to manufacturer specifications, warnings and instructions and agrees to hold SuperATV® harmless from any damage resulting from failure to adhere to such specifications, warnings and/ or instructions. The Buyer is also responsible to obey all applicable federal, state, and local laws and ordinances when operating his/her vehicle while using this product, and the Buyer agrees to hold SuperATV® harmless from any violation thereof.

Do not tighten hardware completely unless noted. Keep all components removed from machine.

- Remove stock Bumper and Facia.



- Remove Plate and Radius Arms hardware.





Cut area shown from Heat Shield if present.

(Driver)

- Drill through Frame as shown. Hole to be straight and large enough to accept $\text{\O}10\text{mm}$ Bolt.
- Repeat for opposite side.
- Reinstall Rear Fascia.

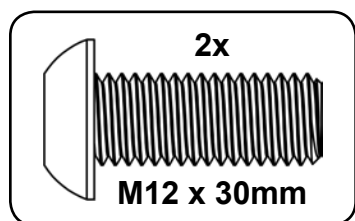
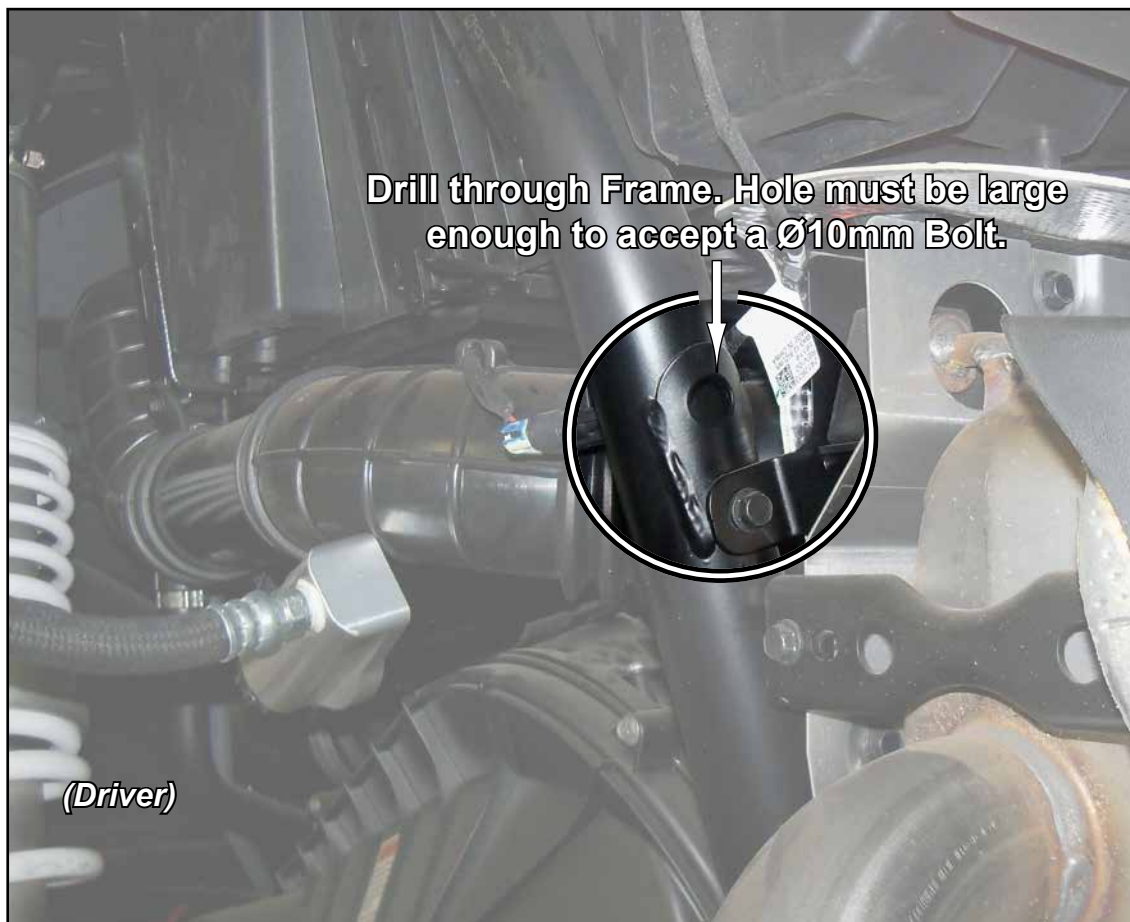

- Install Mounts (C) to Upper (A).
- Install End Caps (E) to Upper (A) with hardware shown.

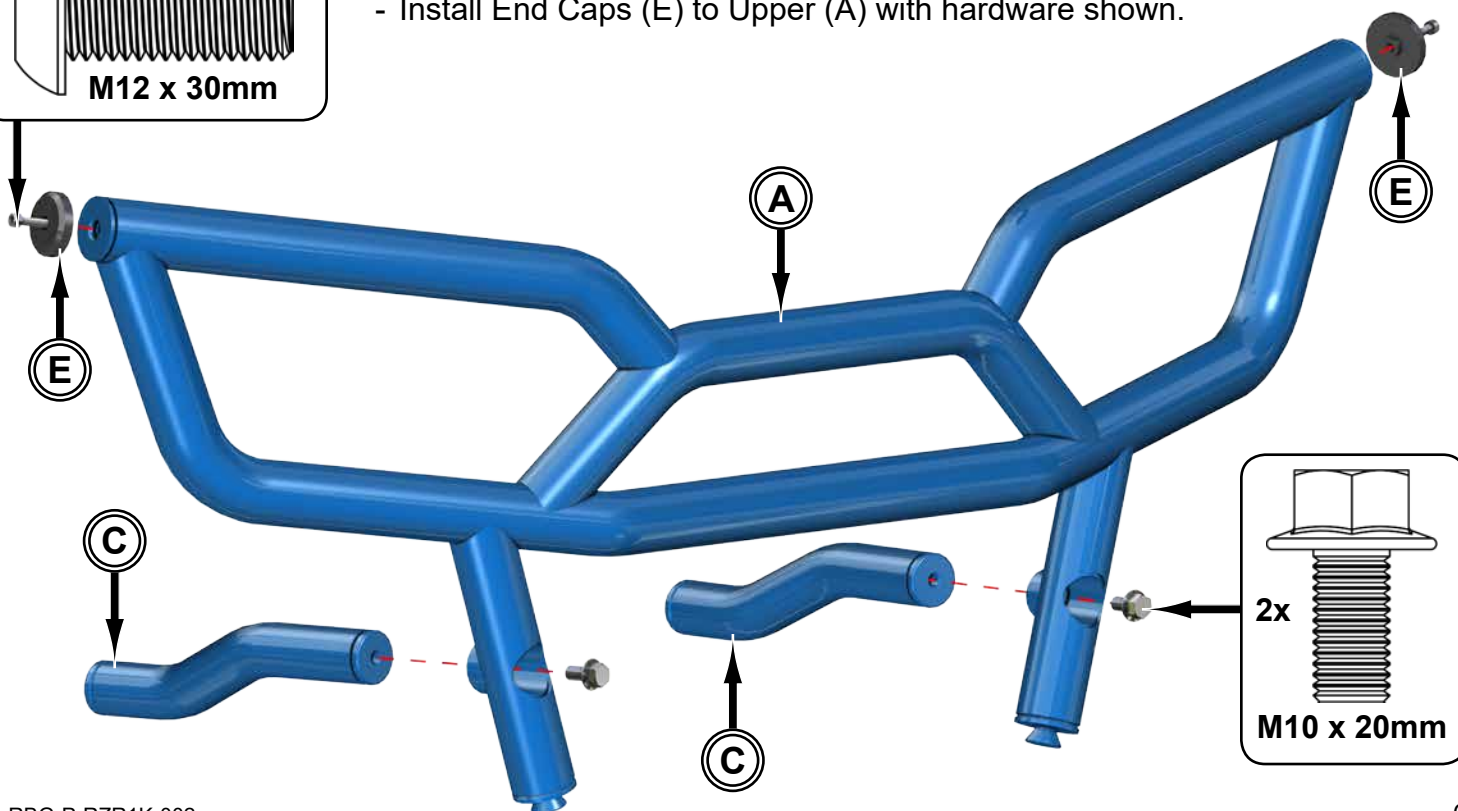

- Secure Upper (A) to Frame with hardware shown.

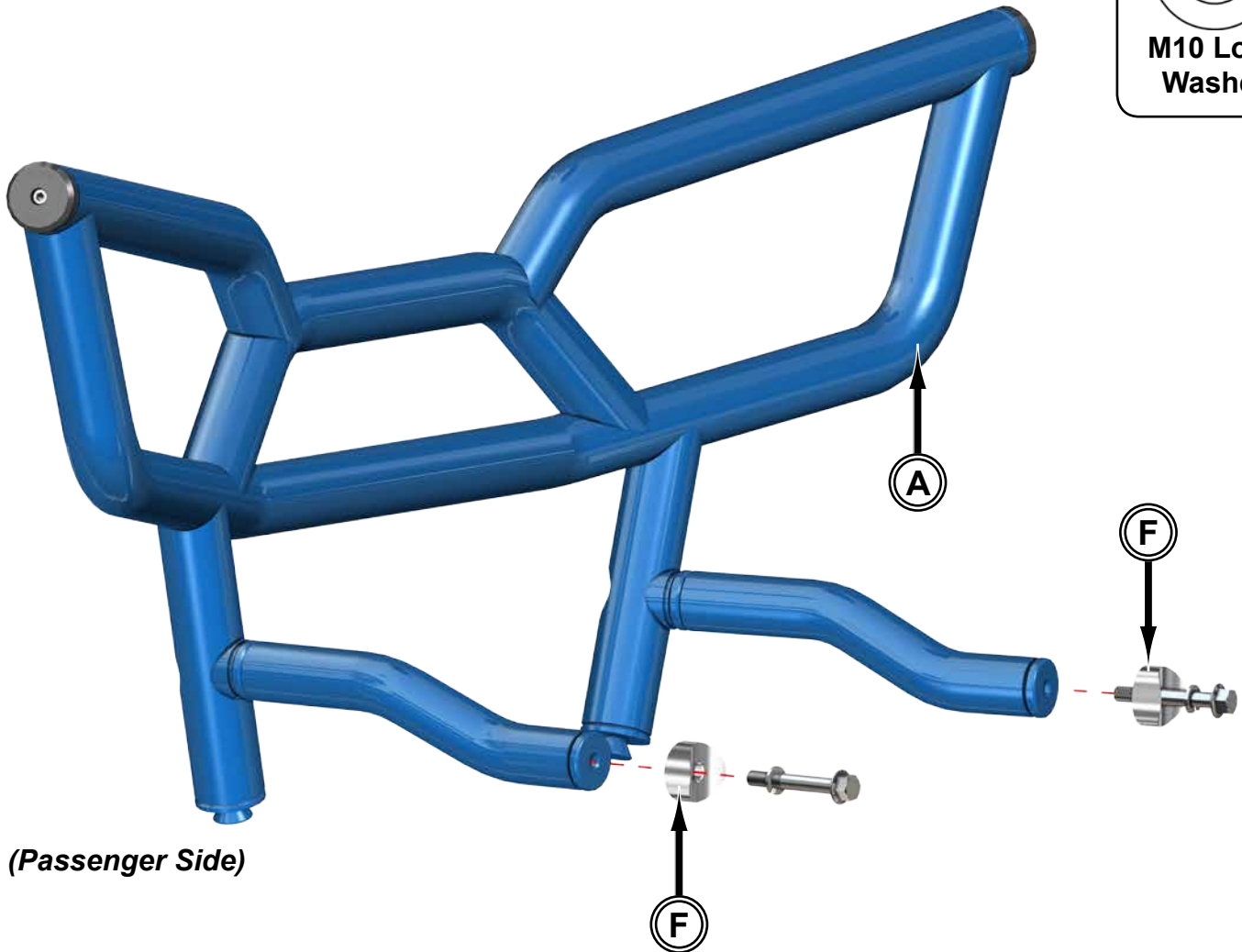
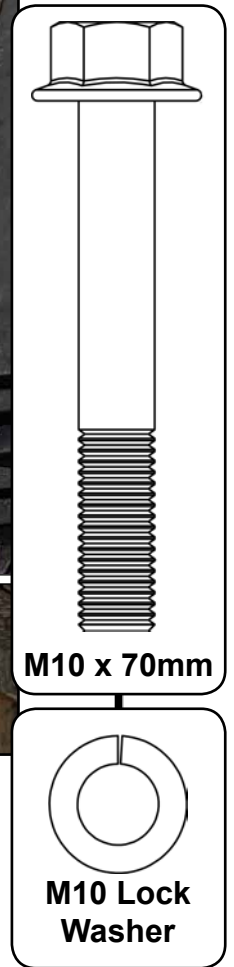
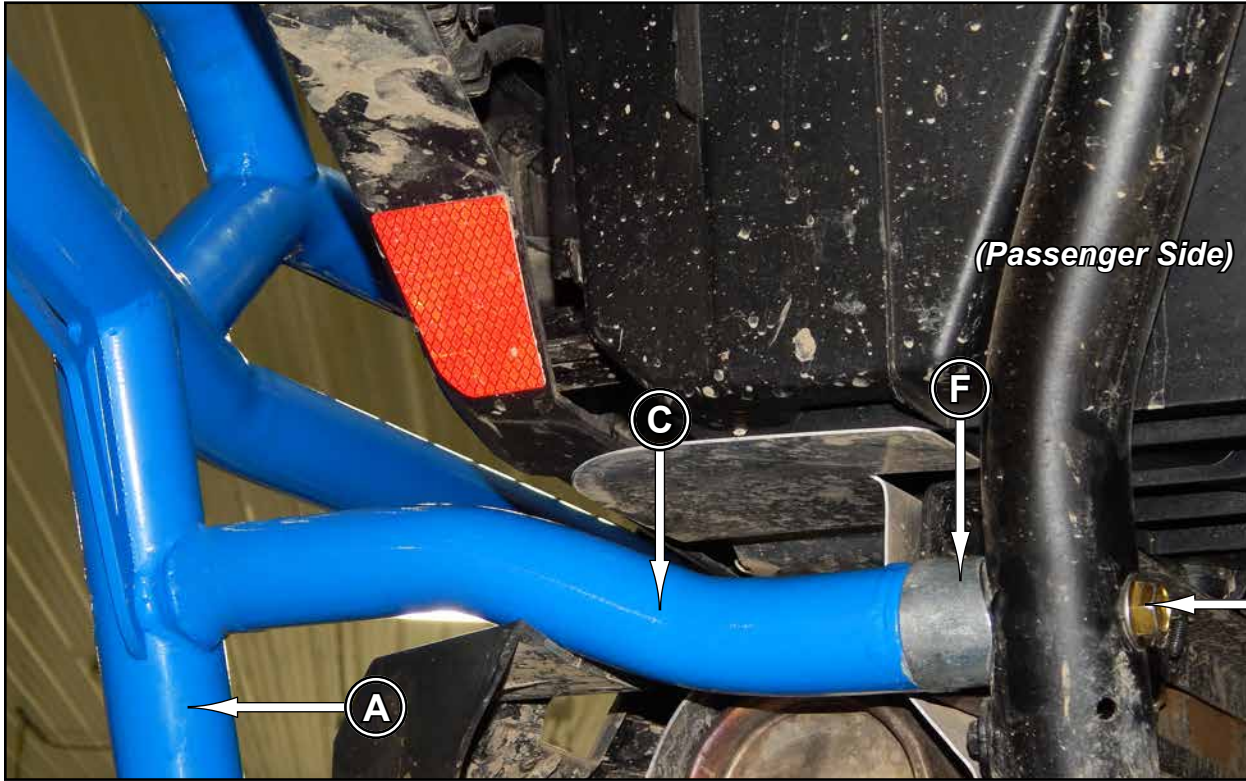

- Install Lower (B) to Frame with hardware shown.
- Join Upper (A) and Lower (B) with Clamps (D).
- Align to machine and tighten all hardware completely.

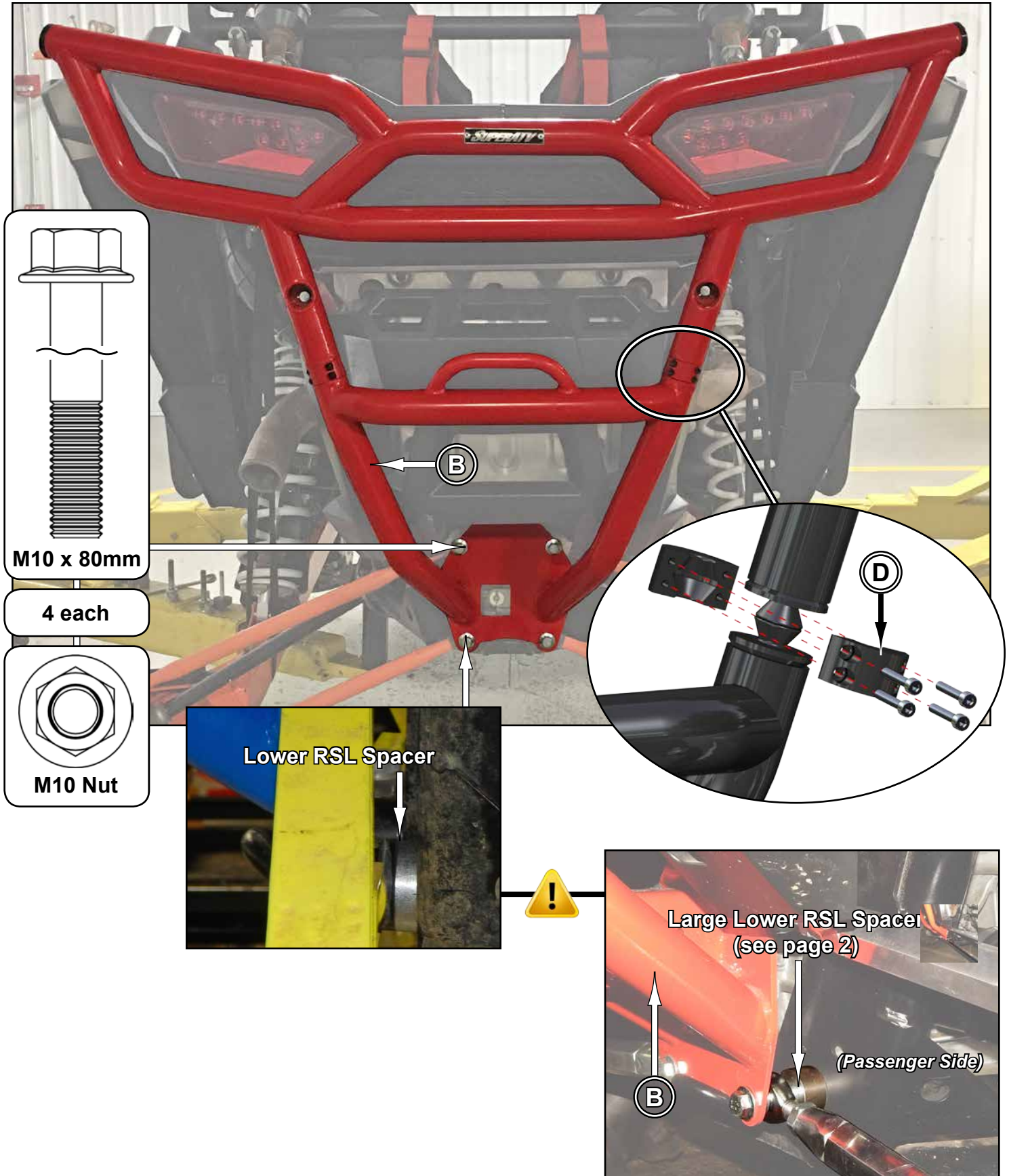



- Due to manufacturer changes, some machines have different size mounting holes.
- If stock RSL hardware will not fit into mounting holes of Lower (B), installer must drill mounting holes in Lower (B) large enough to accept $\text{\O}12\text{mm}$ bolts.

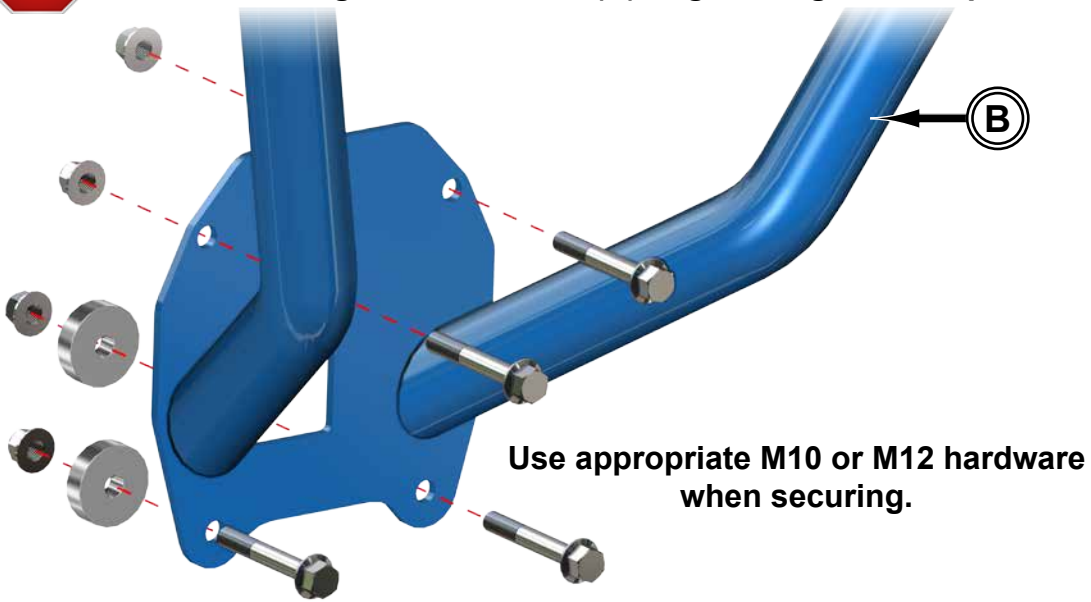

If SuperATV p/n FP-P-RZR1K-003 Rear Fender Protectors are installed, Rear Brush Guard may need to be spaced away from Frame for best fit:

- Use Fender Washers and/or Upper RSL Spacers as needed.
- Due to machine variations, different combinations of components may be required.
- Keep hardware for future use if Rear Fender Protectors are not installed.

