

A Press or Ball Joint tool is required to remove and install Ball Joints.

Upper A-Arm (A)



(Passenger)

Lower A-Arm (B)

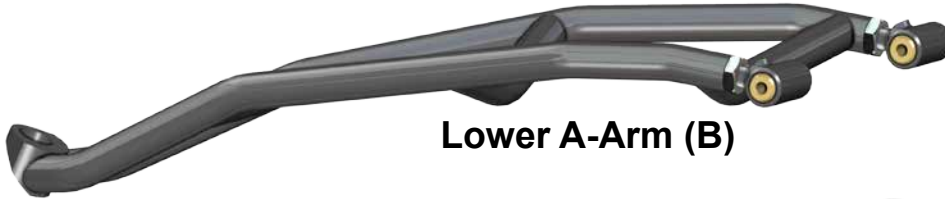

Upper A-Arm (C)



(Driver)

Lower A-Arm (D)



Front Lift Bracket (J)

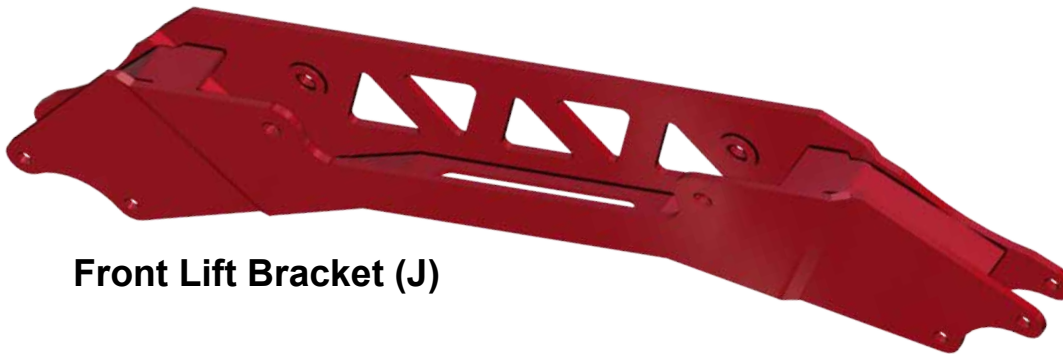

(Kit contents continue on following pages)



- FRONT Stock Sway Bar cannot be used.

Need help with your installation?



sales@superatv.com



www.superatv.com



1-855-743-3427



8:00am - 8:00pm EST M-Th
 8:00am - 7:00pm EST Friday
 9:00am - 2:00pm EST Saturday

Read instructions and view illustrations before beginning.

Thank You

For Choosing



(Kit contents continued)

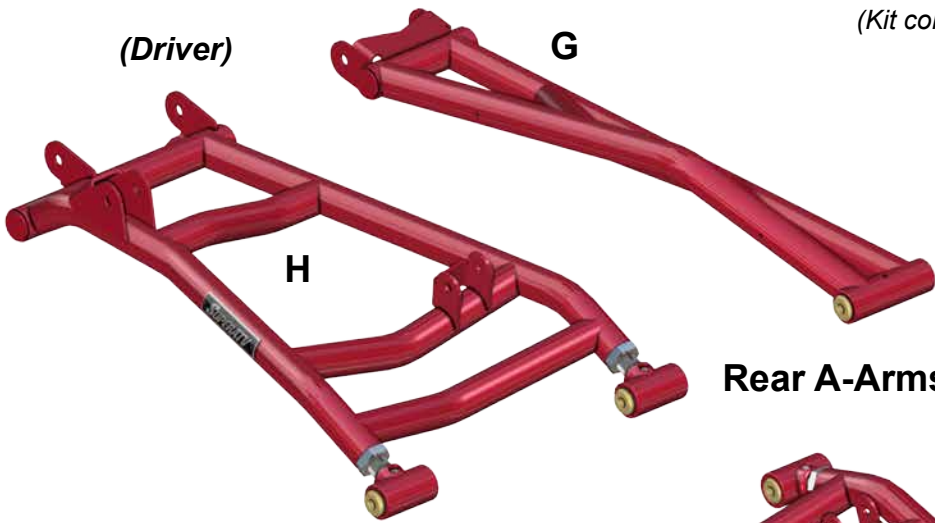

Item	Description
E	Upper A-Arm, Passenger
F	Lower A-Arm, Passenger
G	Upper A-Arm, Driver
H	Lower A-Arm, Driver

Rear A-Arms



Item	Description	Qty
K	Rear Shock Bracket Brace	1
L	Shock Bracket Base, Left	1
M	Shock Bracket Base, Right	1
N	Shock Brackets	2

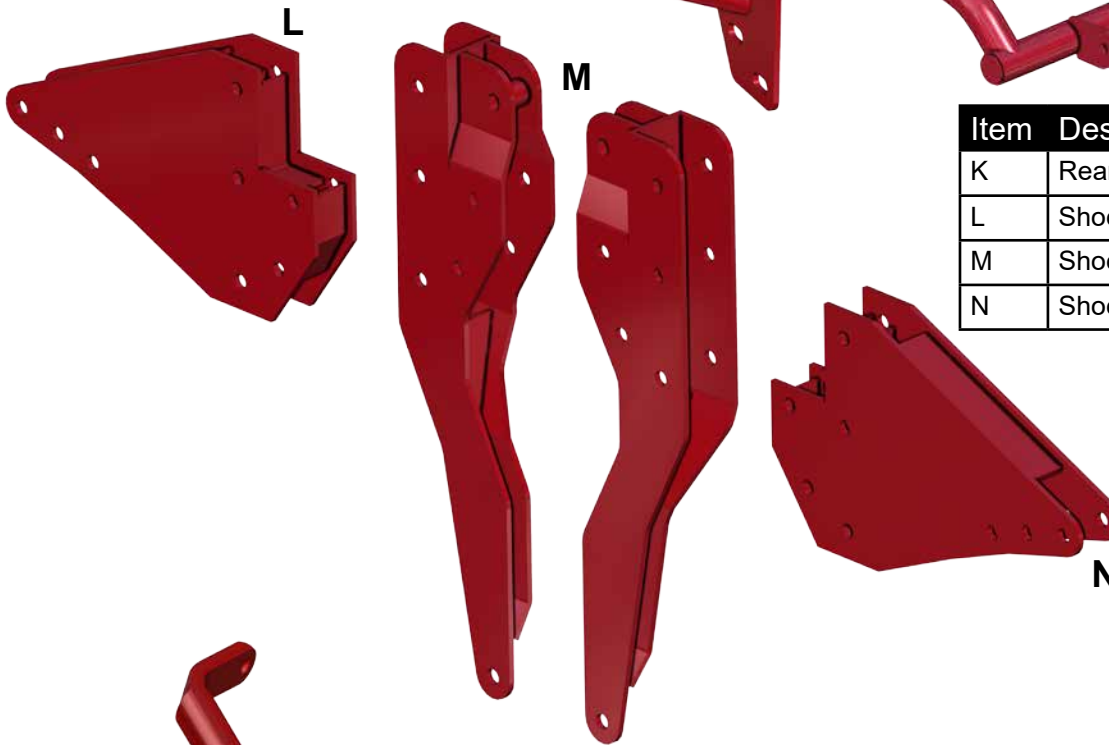

(Q) Rear Sway Bar - USE ON 900 MODELS ONLY

NOT INCLUDED FOR OR USED ON RZR S 900



(Kit contents continued)

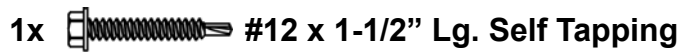
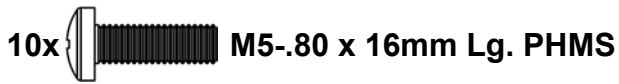
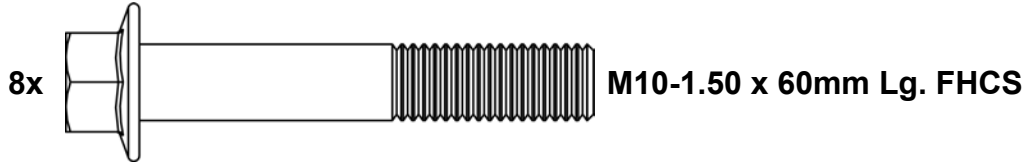
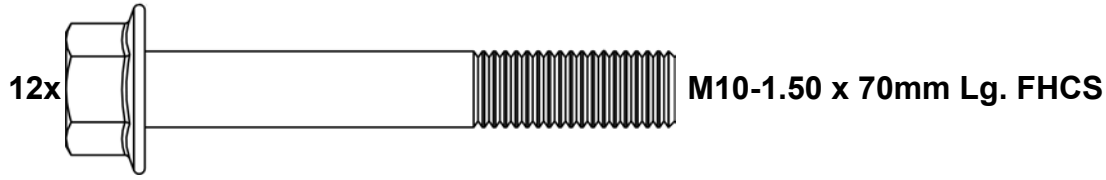
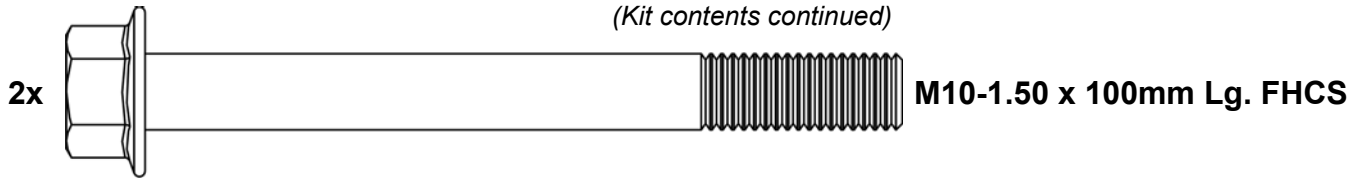

Brake Line Clamps

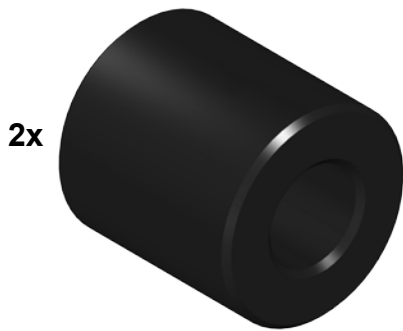

Pivot Bushing Spacer



Brake Lines (P)

Location	Length (Approx)
Right Front	56"
Left Front	42"
Right Rear	60"
Left Rear	48"

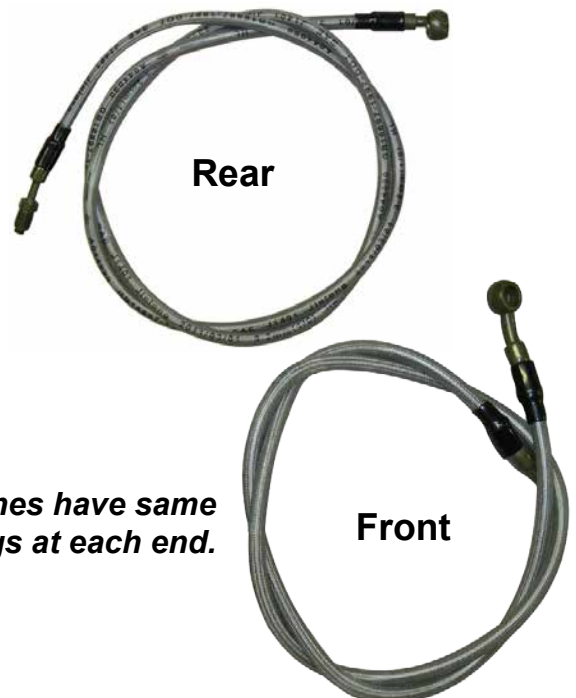

Front Brake Lines have same style fittings at each end.

Liability Statement

SuperATV's® products are designed to best fit user's ATV/UTV under stock conditions. Adding, modifying, or fabricating any factory or aftermarket parts will void any warranty provided by SuperATV® and is not recommended. SuperATV's® products could interfere with other aftermarket accessories. If user has aftermarket products on machine, contact SuperATV® to verify that they will work together.

Although SuperATV® has thousands of satisfied customers, user should be aware that installing lift kits, long travel, or suspension kits, tires, etc. will change the ride of machine and may increase maintenance and part wear. Operating any off-road machine while, or after, consuming alcohol and/or drugs increases risk of bodily harm or death. No warranty or representation is made as to this product's ability to protect user from severe injury or death. SuperATV® urges operators and occupants to wear a helmet and appropriate riding gear at all times.

By purchasing and installing SuperATV® products, user agrees that should damages occur, SuperATV® will not be held responsible for loss of time, use, labor fees, replacement parts, or freight charges. SuperATV®, nor any 3rd party, will not be held responsible for any direct, indirect, incidental, special, or consequential damages that result from any product purchased from SuperATV®. The total liability of seller to user for all damages, losses, and causes of action, if any, shall not exceed the total purchase price paid for the product that gave rise to the claim.

SuperATV® will warranty only parts provided by SuperATV®. Any damage or problems with OEM housings, bearings, seals, or other manufacturers' products will not be covered by SuperATV®. SuperATV® parts and products are not warranted if item was not installed properly, misused, or modified.

Installing, adding, modifying, or fabricating any factory or aftermarket product to your ATV/UTV may violate certain local, state, and federal laws. Be advised that laws vary depending on town, city, county, state, etc. Use of certain products on public streets, roads, or highways may be in violation law. The Buyer is solely and exclusively legally and personally responsible for any violation of the law by the installation or use of the product. You must abide by all local, state, and federal laws, including but not limited to vehicle safety, traffic laws, and ordinances. It is your responsibility to know the laws and how they apply to you.

The Buyer is responsible to fully understand the capability and limitations of his/her vehicle according to manufacturer specifications, warnings and instructions and agrees to hold SuperATV® harmless from any damage resulting from failure to adhere to such specifications, warnings and/ or instructions. The Buyer is also responsible to obey all applicable federal, state, and local laws and ordinances when operating his/her vehicle while using this product, and the Buyer agrees to hold SuperATV® harmless from any violation thereof.

Phantom Pro-Sport Series Shocks Settings:



Front components shown must be removed; *Keep all components removed from machine.*

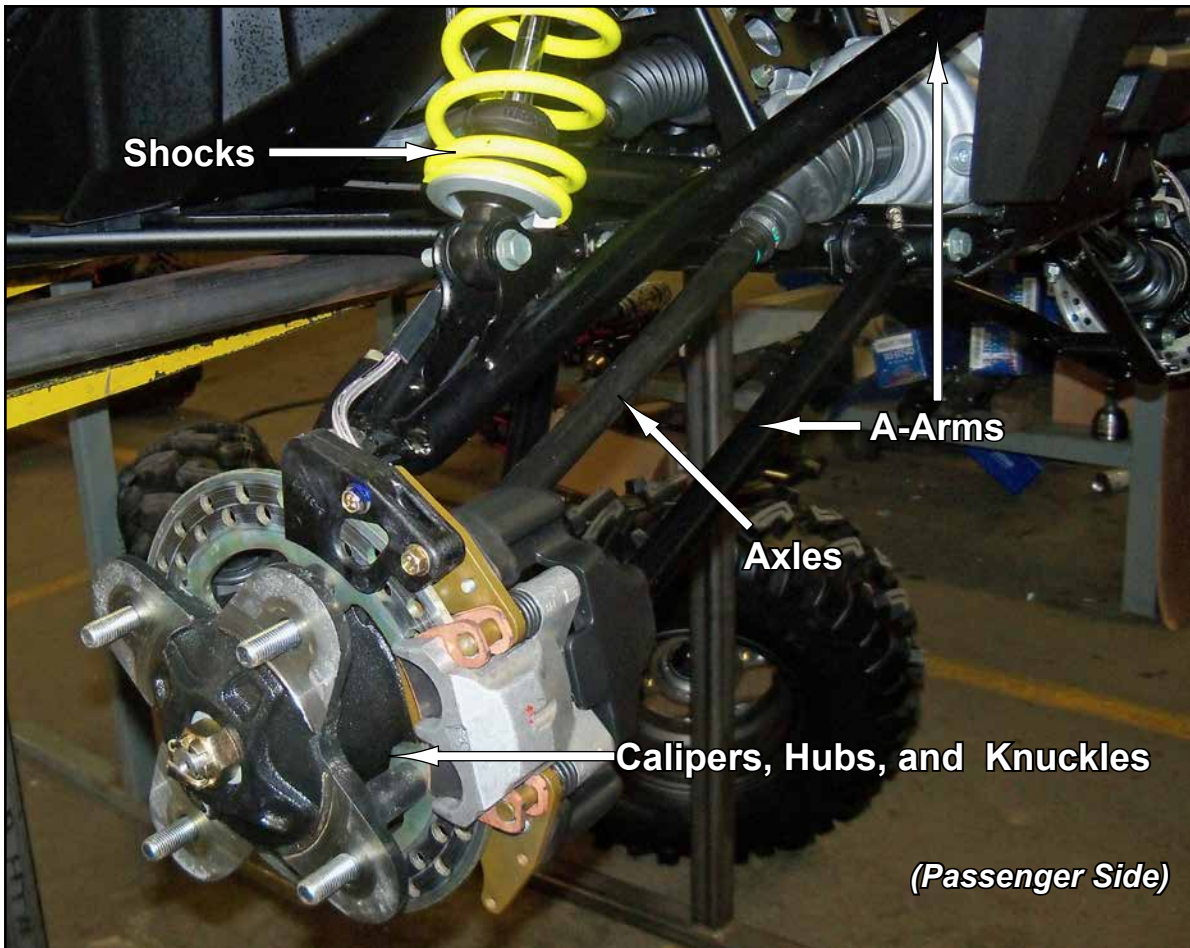

Front removal continued, General only:



Vent Tube Rerouting:

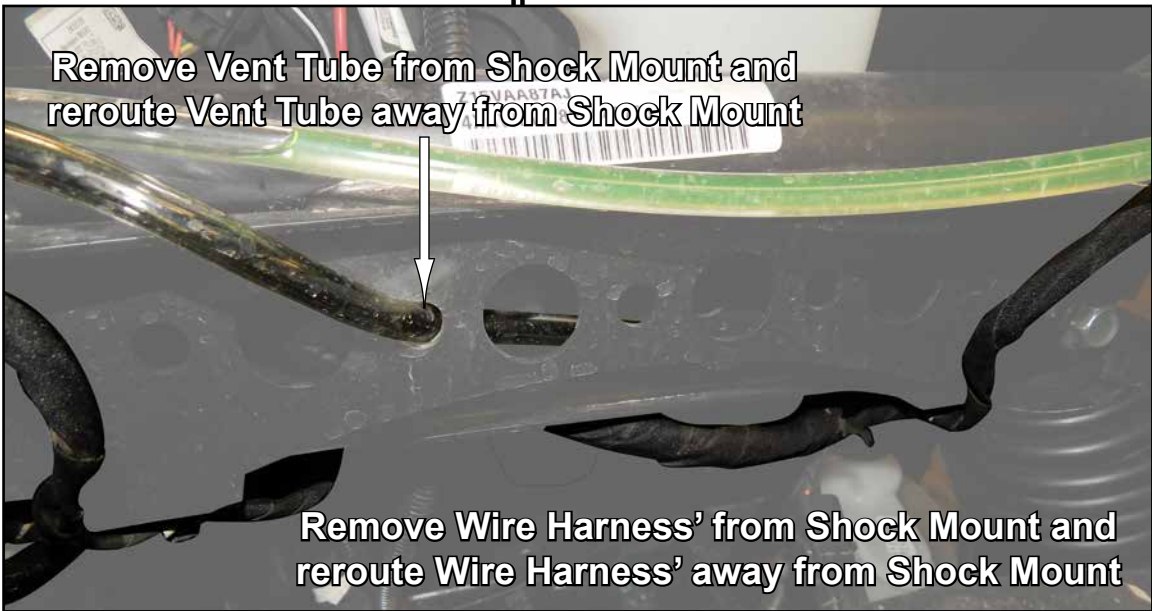
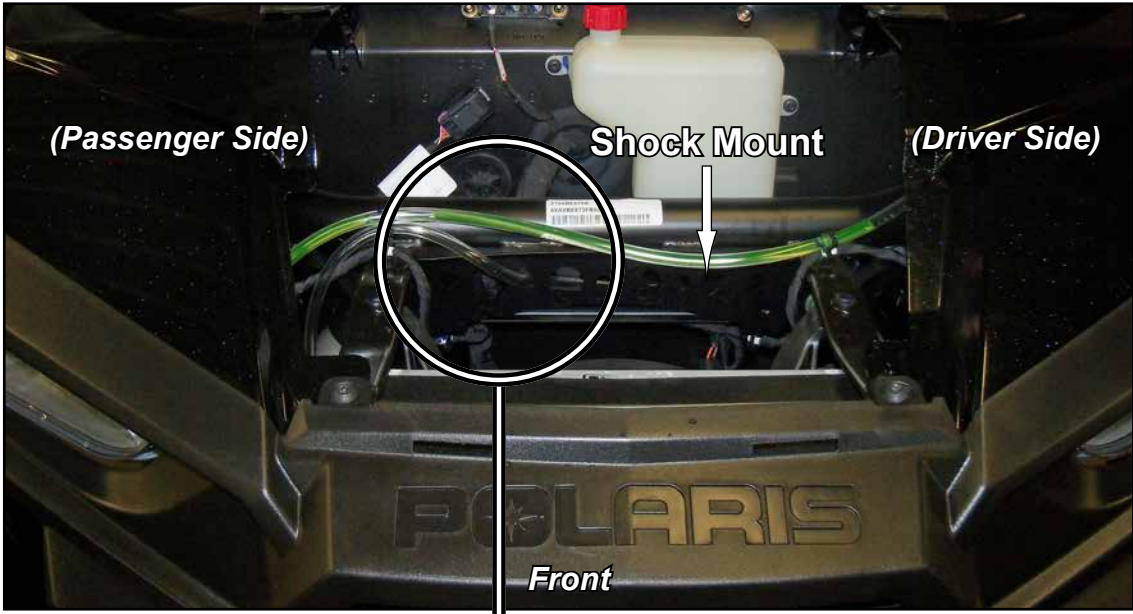

Steering Stop Installation: *Rack and Pinion shown off machine for clarity*

Note: Driver Side installation is shown.

- Install Bushing onto Rack and Pinion shaft; repeat for opposite side. See Fig. 1.

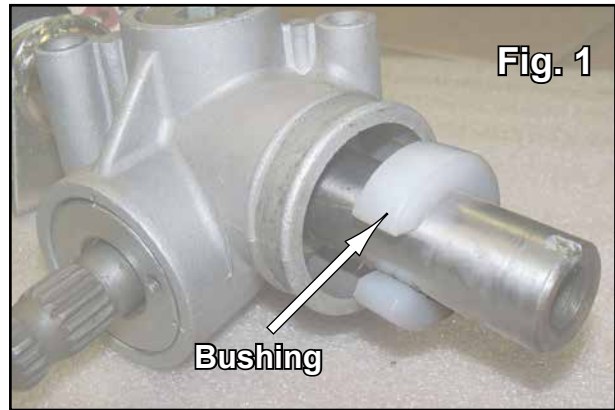
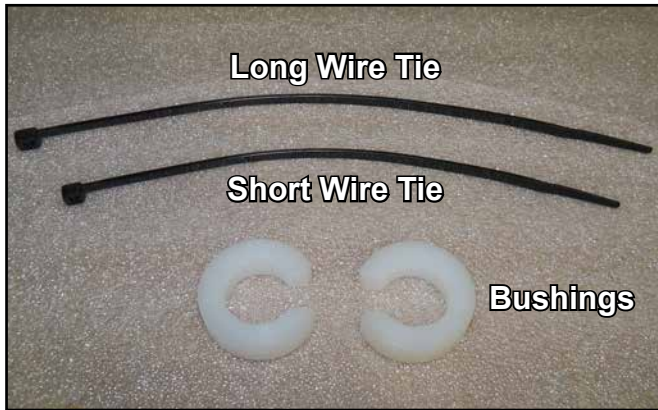

Leave Boots off Rack and Pinion; new Tie Rods will be installed later.

Front A-Arms Prep: *Do not tighten hardware completely until last step.*

Install Fittings and stock Ball Joints to A-Arms

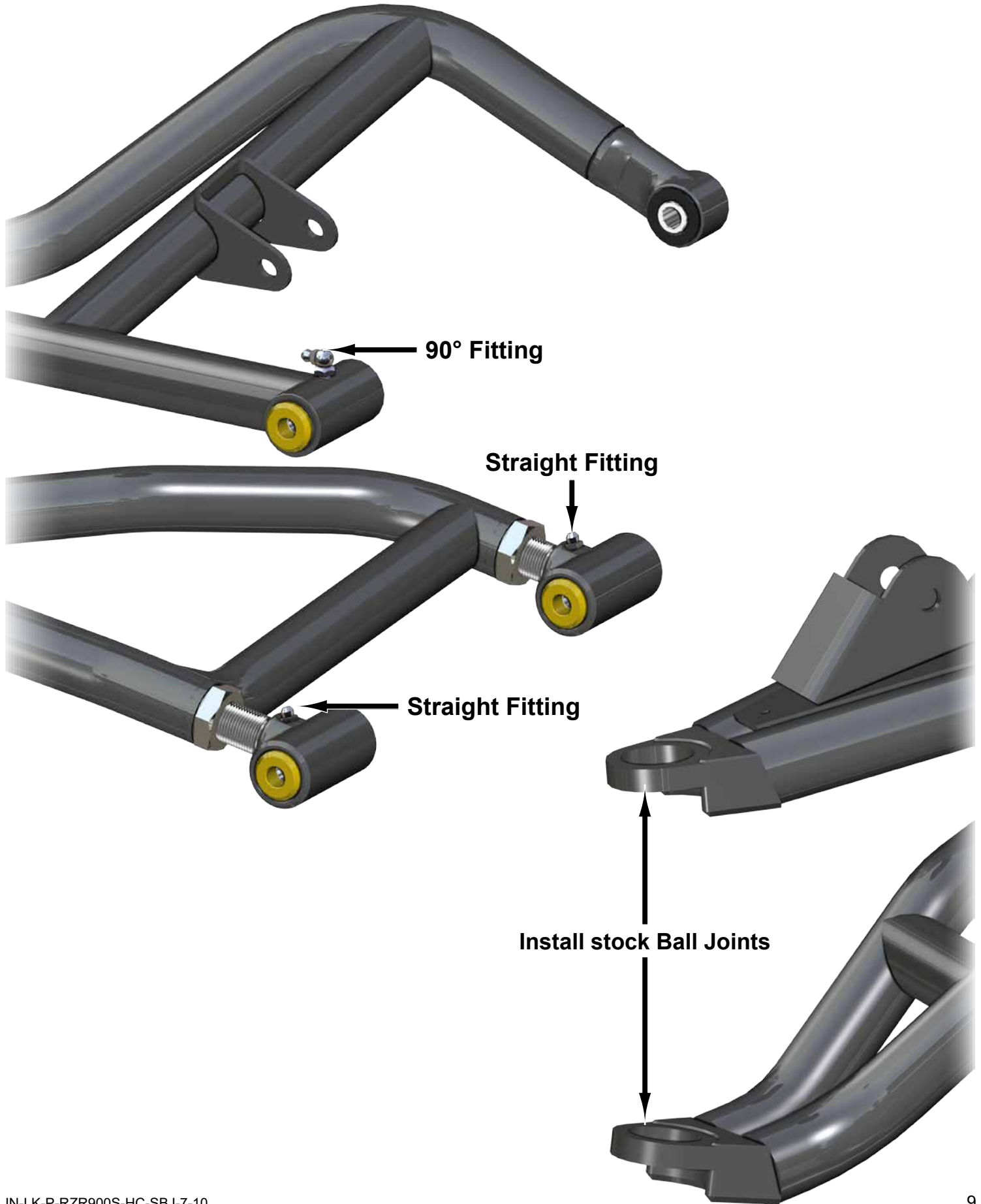

PIVOT BLOCK SETTINGS

- Place new A-Arms onto a flat surface and verify dimension shown.
- *Negative 1° camber setting is achieved when Pivot Blocks are set to this dimension.*
- See last page for additional camber information.

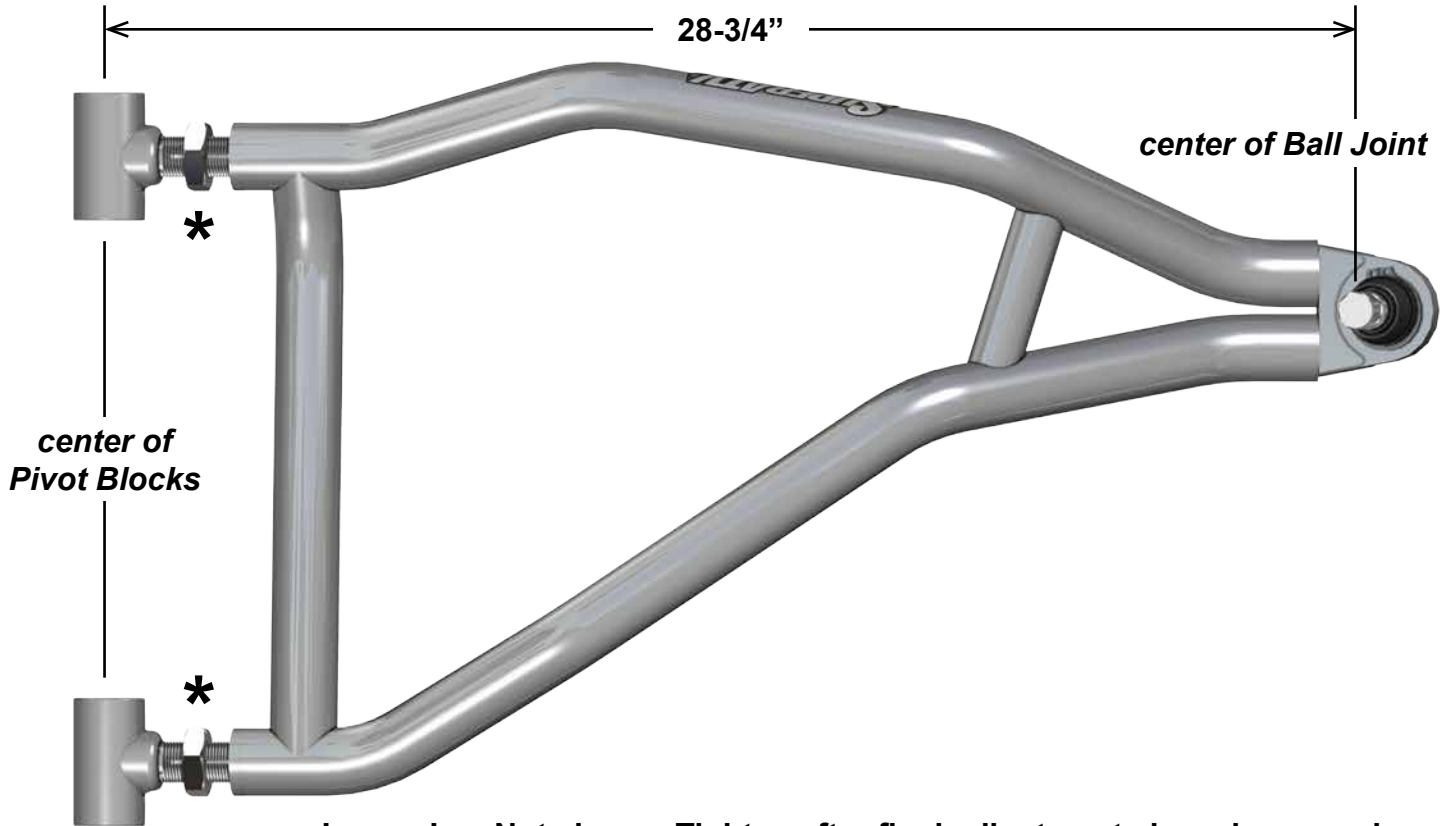

*** Leave Jam Nuts loose. Tighten after final adjustments have been made.**

Front Lift Bracket Installation: *Do not tighten hardware completely until last step.*

- Install Front Lift Bracket (J) to Frame with hardware shown.

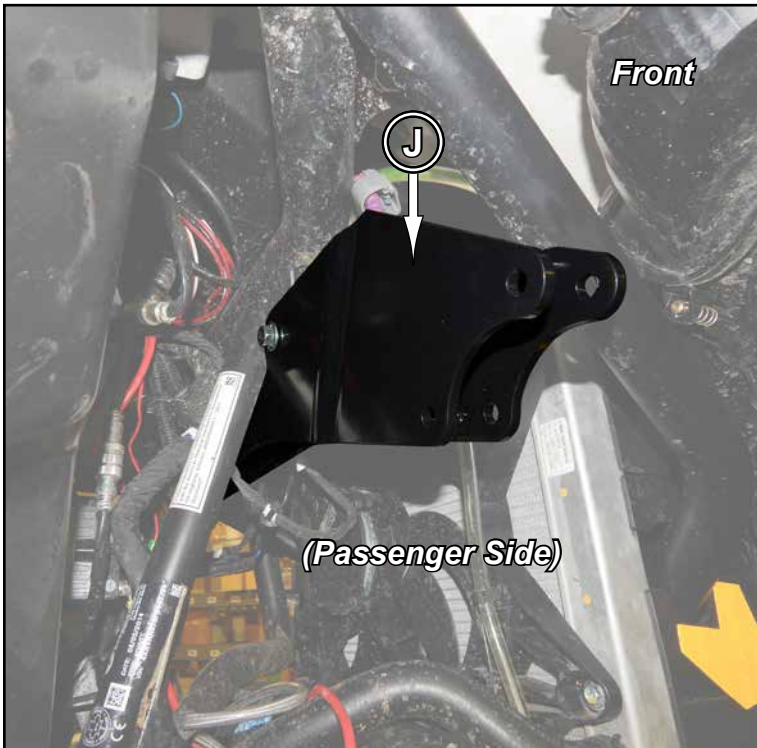
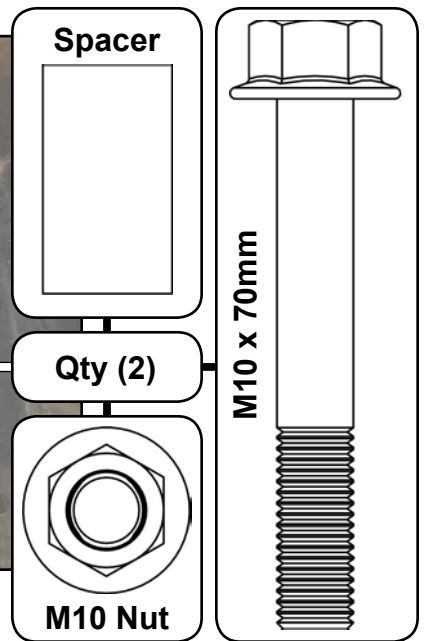
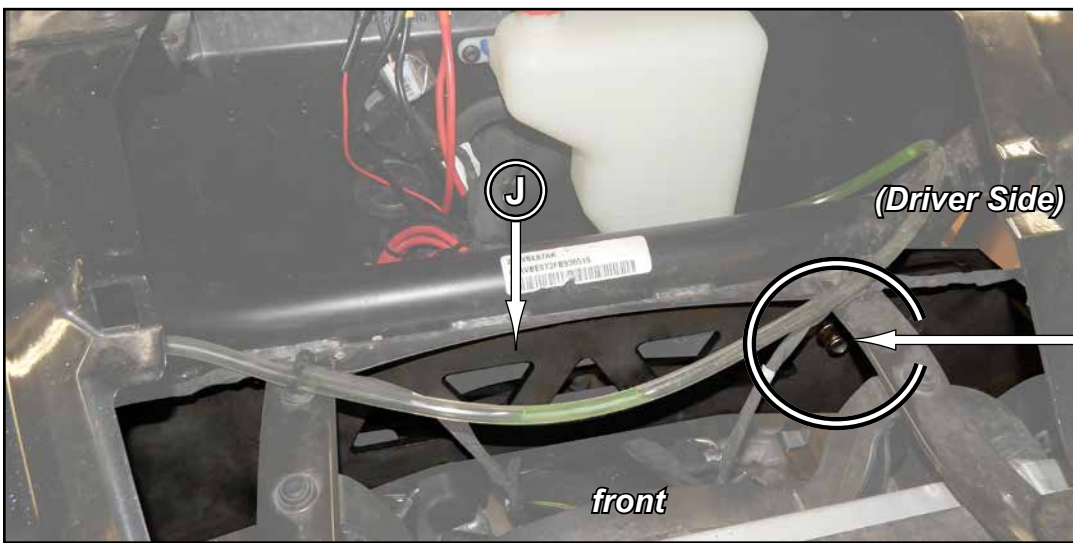
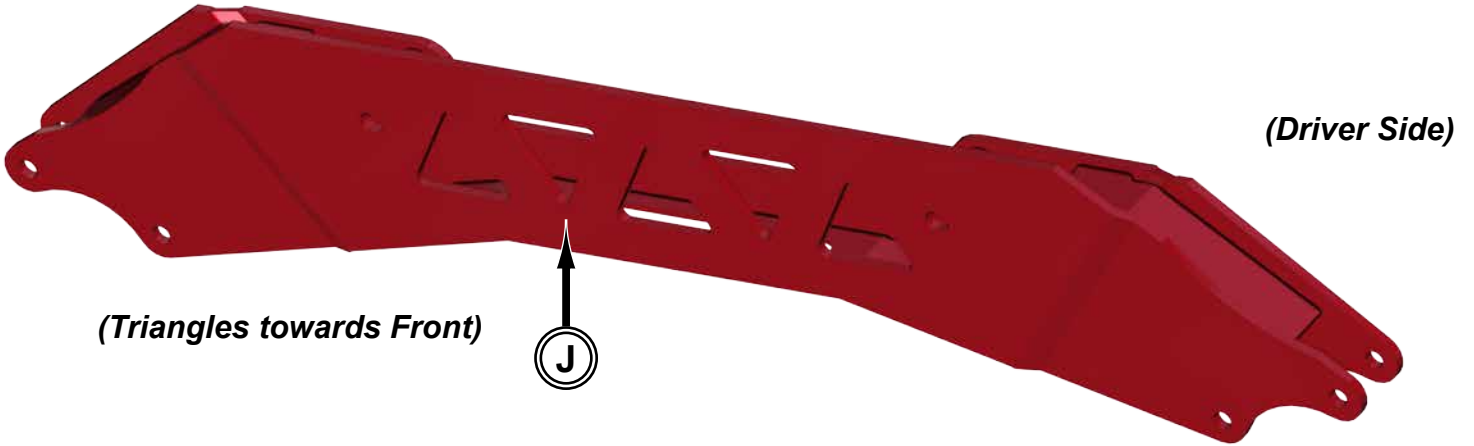

Hint: use needle nose pliers or a telescoping magnet to place Spacers into position.

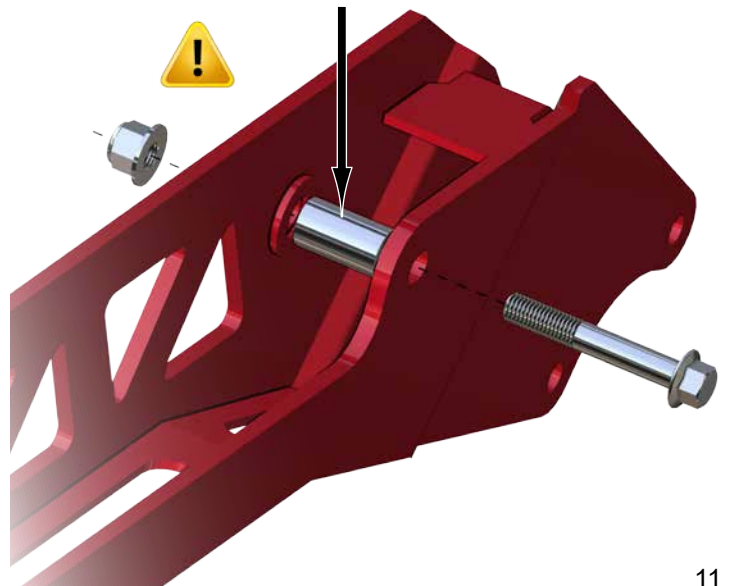

Front Installation: *Do not tighten hardware completely until last step.*

- Install A-Arms (A-D) to Frame with stock hardware. **Do not install any Nuts to Lower Arms until all final adjustments have been completed.**
- Install new Axles.
- Install Tie Rods, **see page 13.**
- Determine desired amount of lift and install Shocks with M10-1.50 x 60mm Lg. FHCS and M10-1.50 Nylock Nuts, **see page 14.**
- Reinstall Calipers, Hubs, Knuckles, etc.
- Install Brake Lines (P), **see page 15.**

Due to manufacturer changes in Frame design, SuperATV Upper A-Arms will fit tightly when installed.

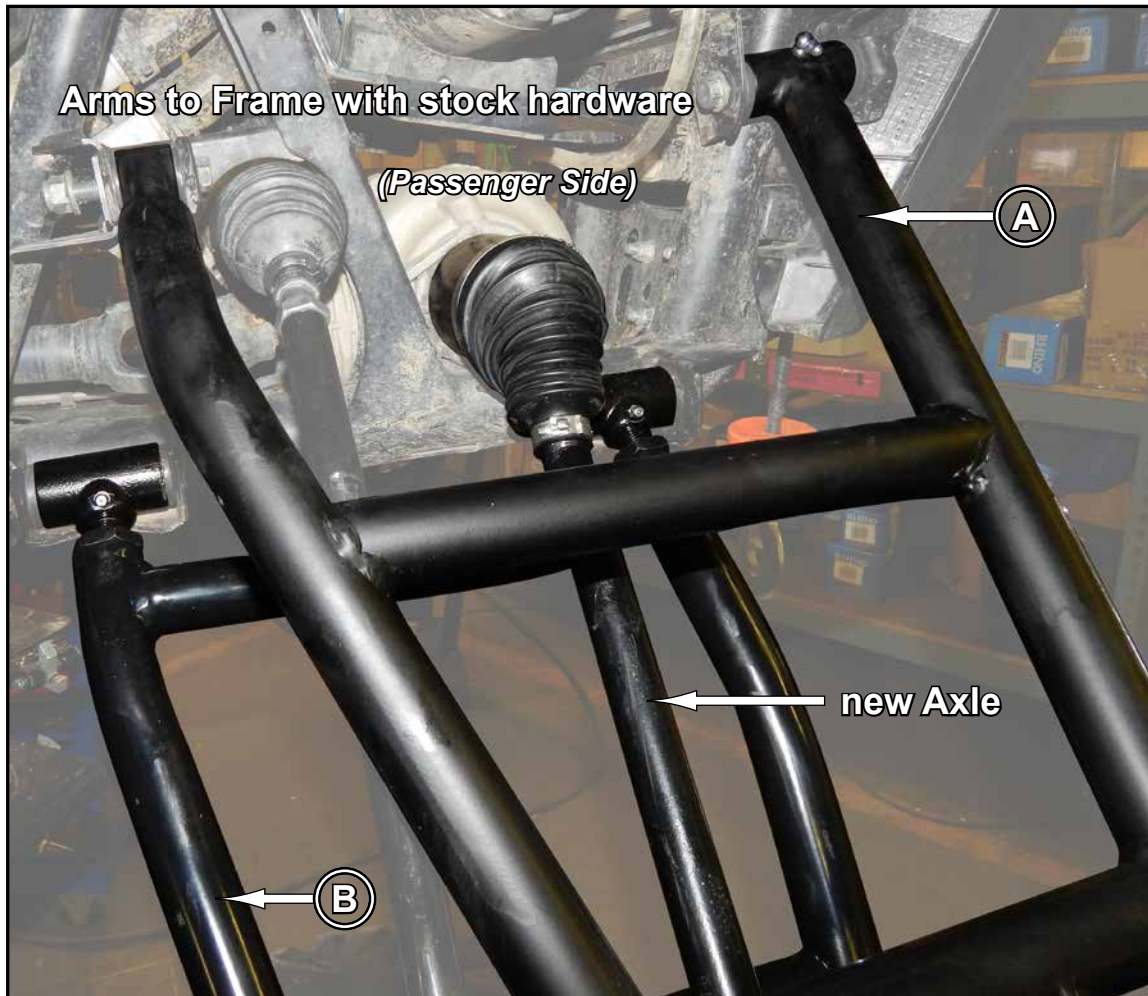

PARTS REFERENCE

Item	Description
A	Upper A-Arm, Passenger
B	Lower A-Arm, Passenger
C	Upper A-Arm, Driver
D	Lower A-Arm, Driver
J	Front Lift Bracket

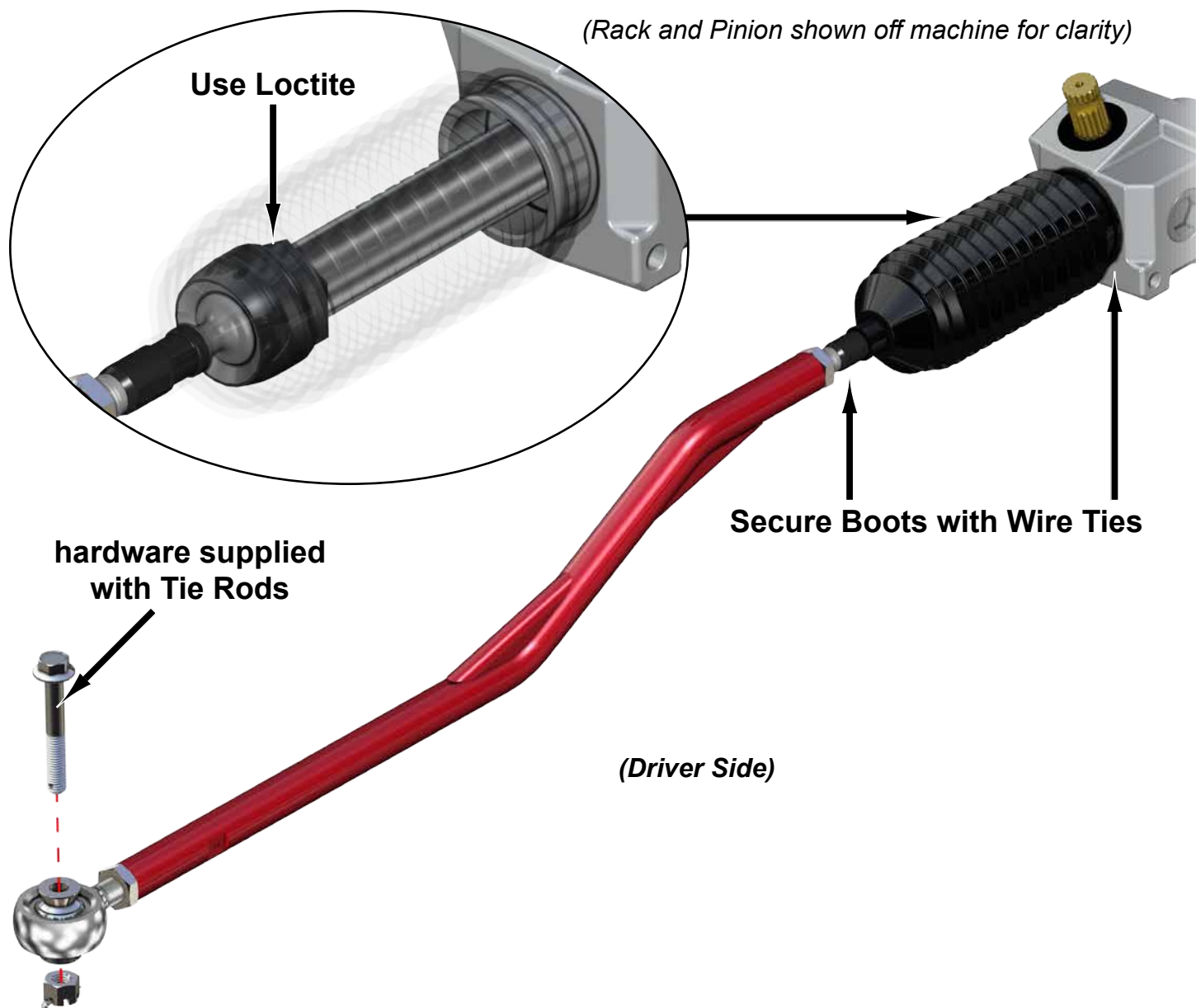
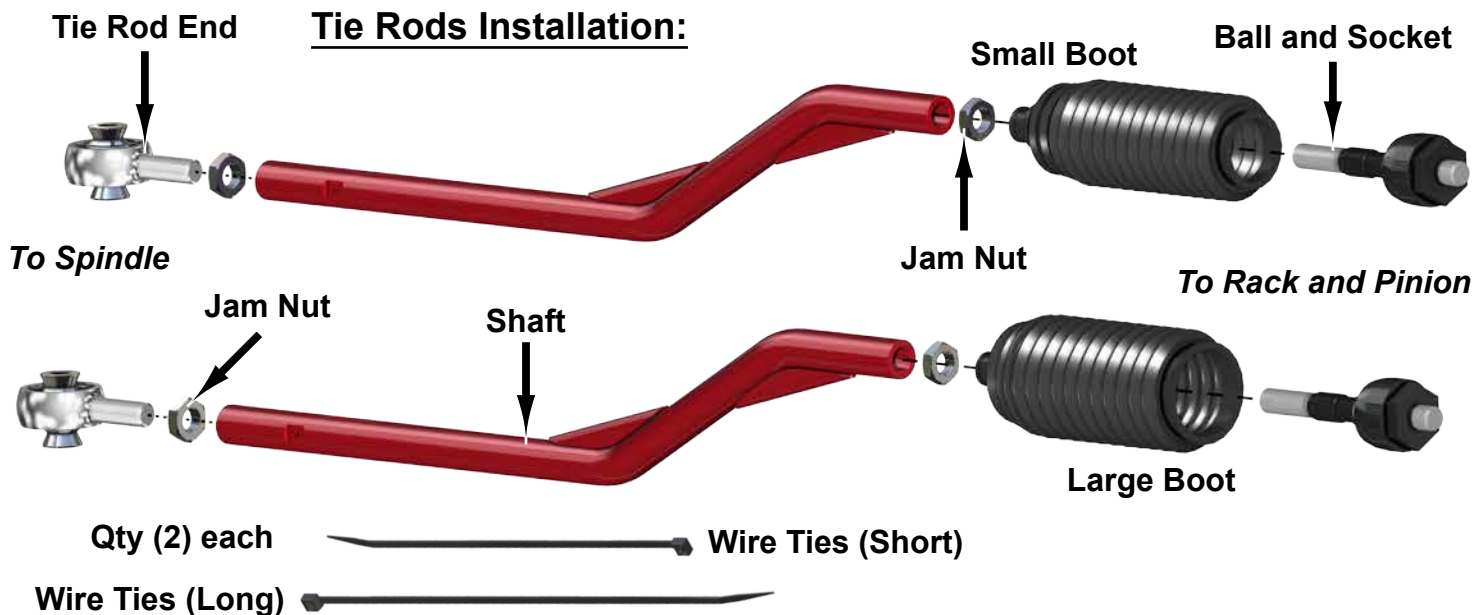

Toe must be set after installation is complete

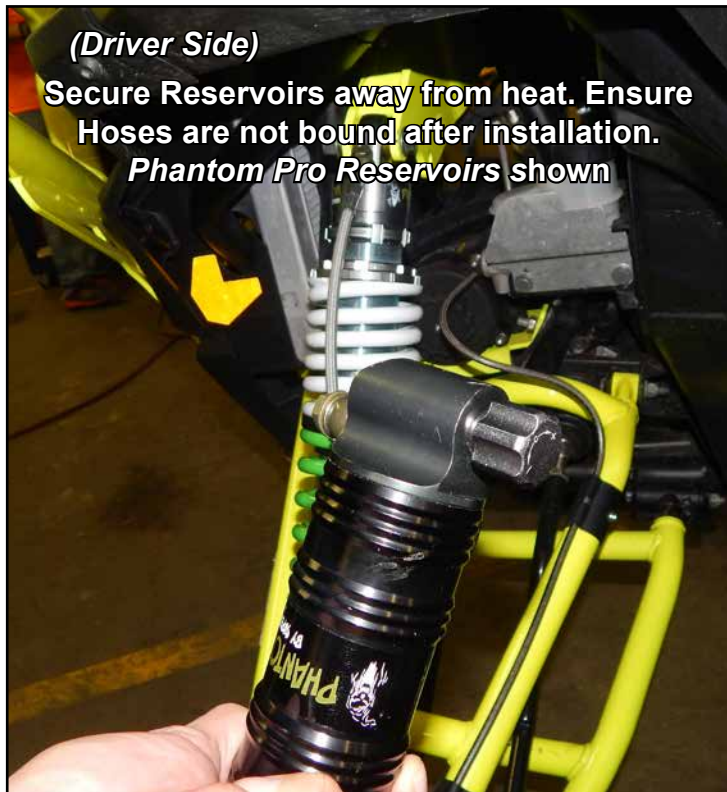
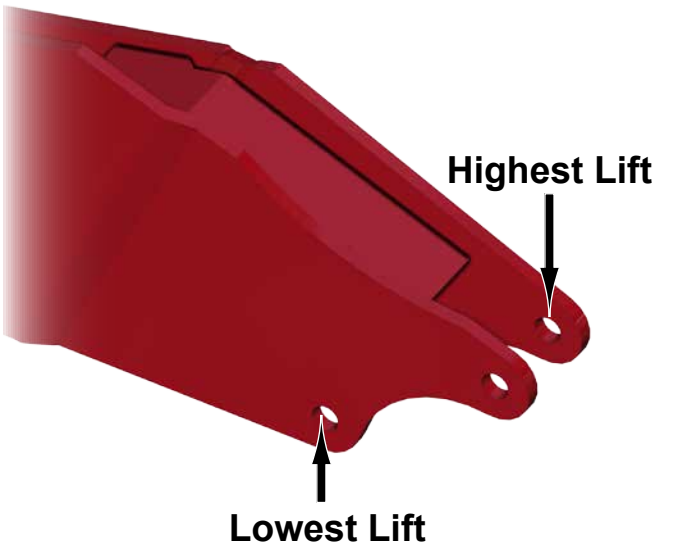
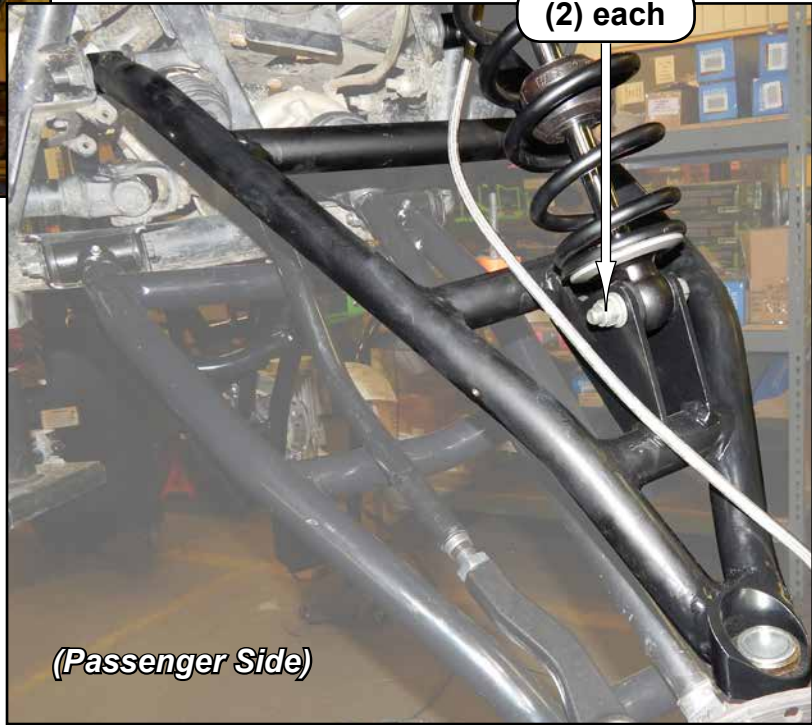
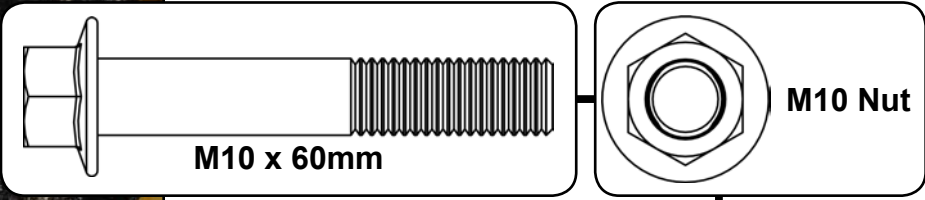
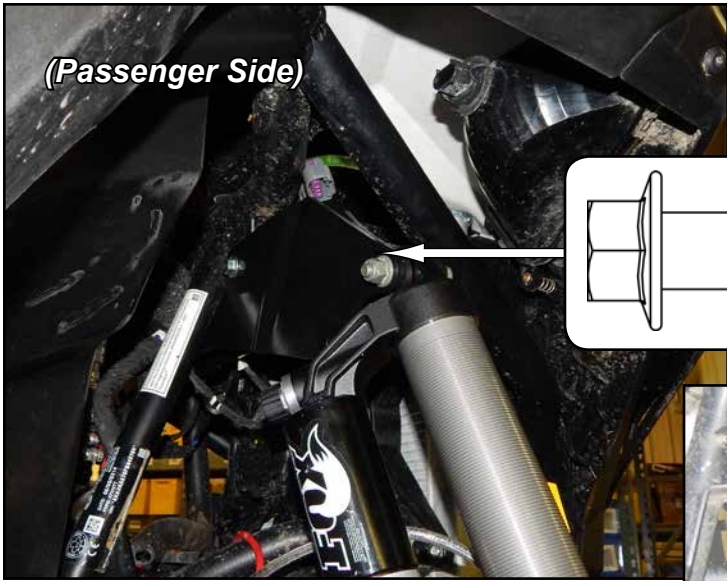

Front Brake Line (P) Installation:

- Secure to A-Arms (A)(C) with Brake Line Clamps and M5-.80 x 16mm Lg. PHMS. Ensure no binding or interference can occur when in use.

Brake Lines (P)

Front Brake Lines have same style fittings at each end.

Location	Lg. (Approx)
Right Front	56"
Left Front	42"

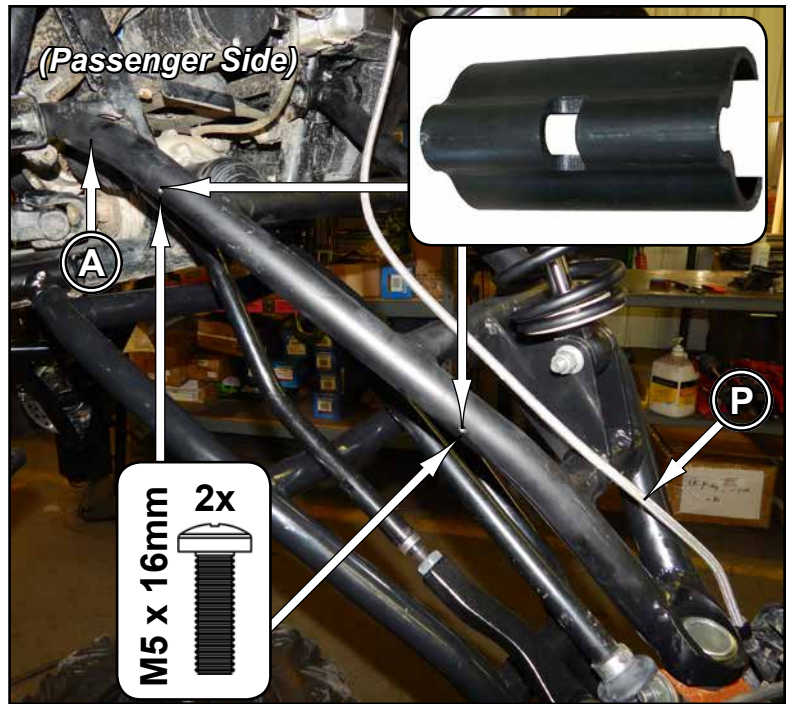

Rear components shown must be removed; *Keep all components removed from machine.*

900 models: Remove Sway Bar and Sway Bar components.
900 S or XC models: Disconnect from A-Arms only.

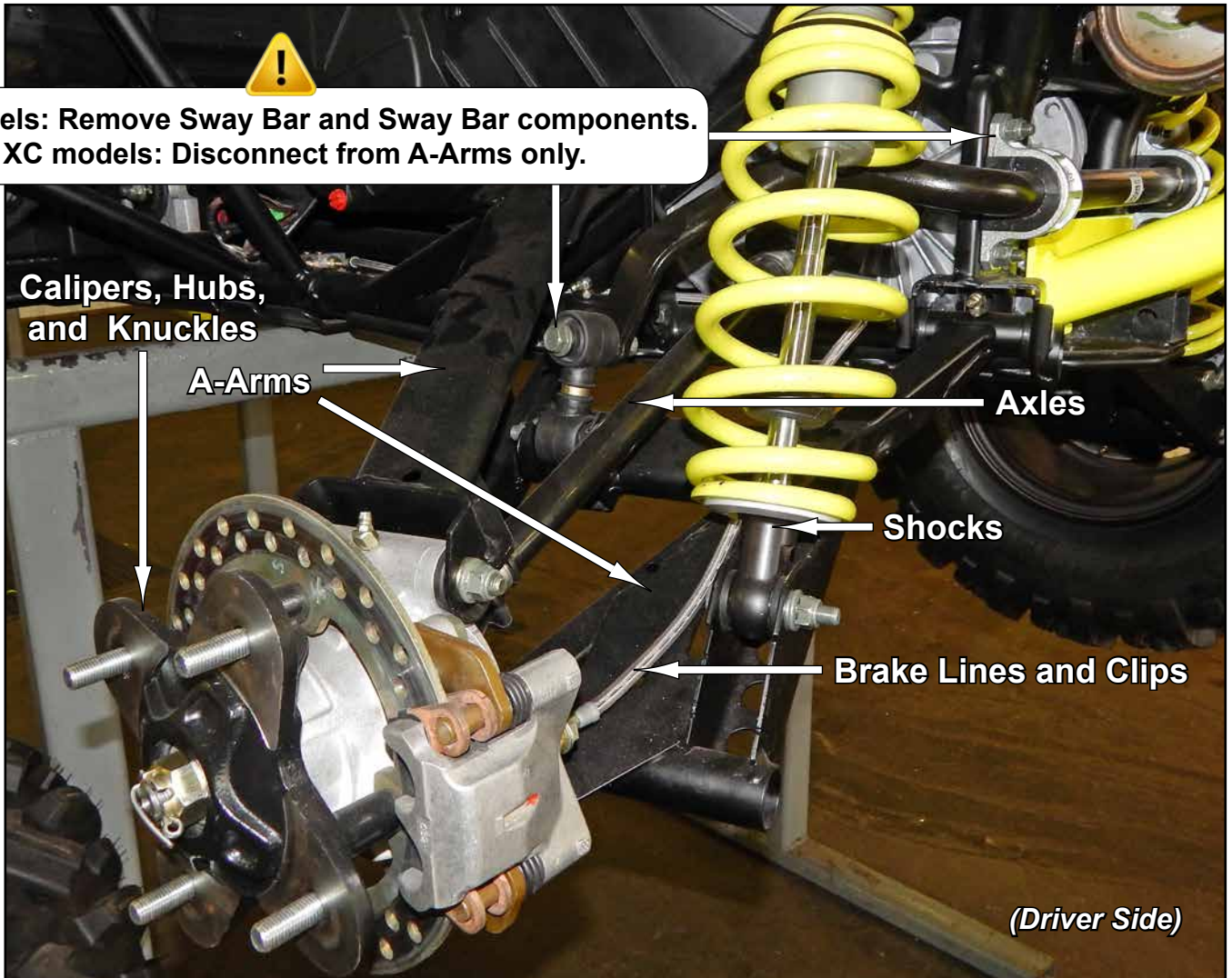

If present, relocate Relay.

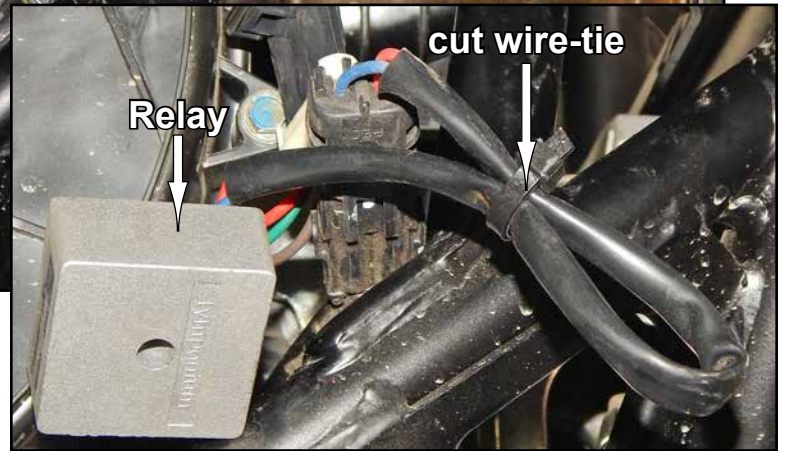
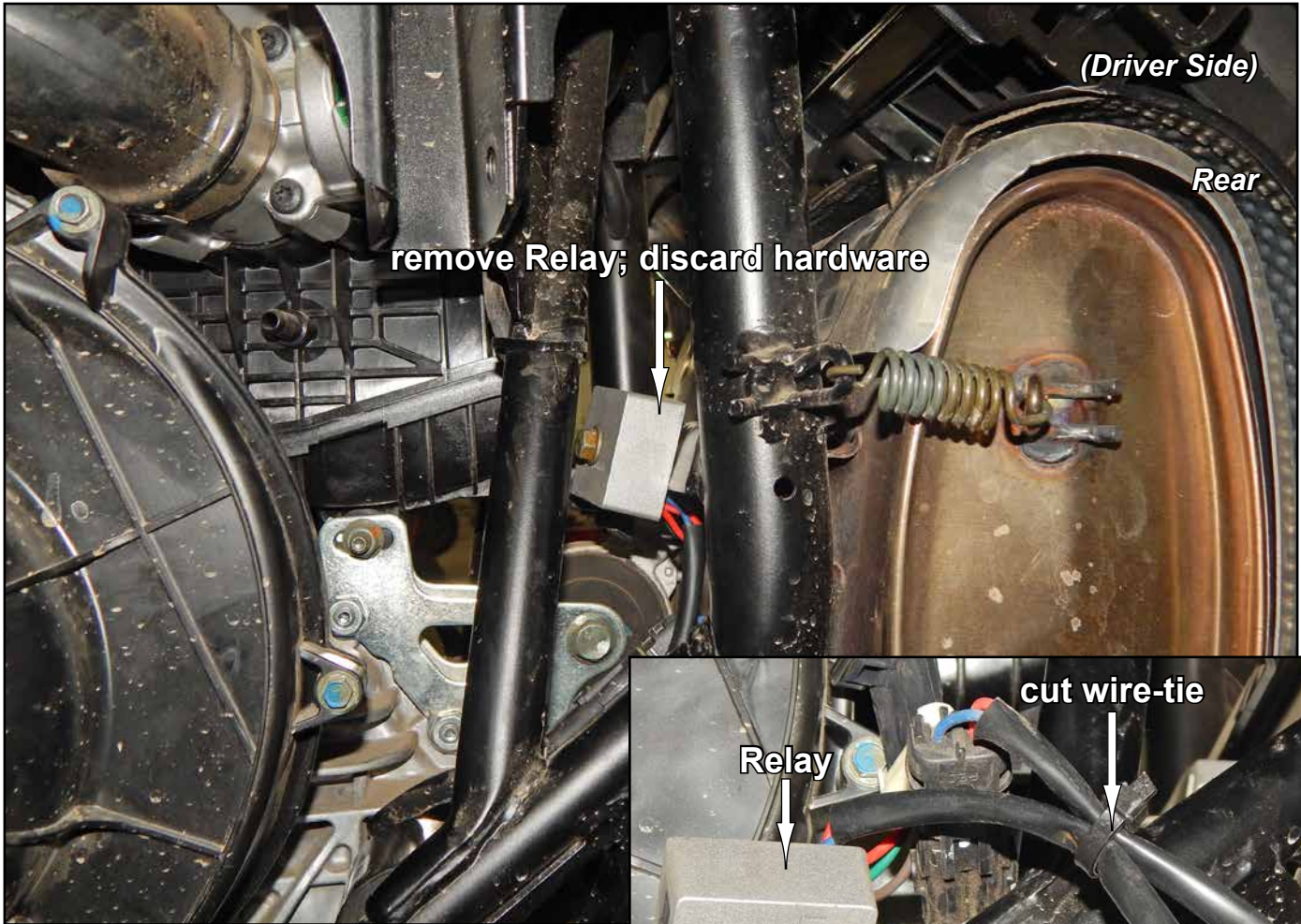

Rear A-Arms Prep: *Do not tighten hardware completely unless noted.*

- Install provided Bearings and Pivot Shafts to new A-Arms.
- Install Zerk Fittings if not present.
- Install Pivot Bushing Spacers to Lower A-Arms (H)(F) as shown.

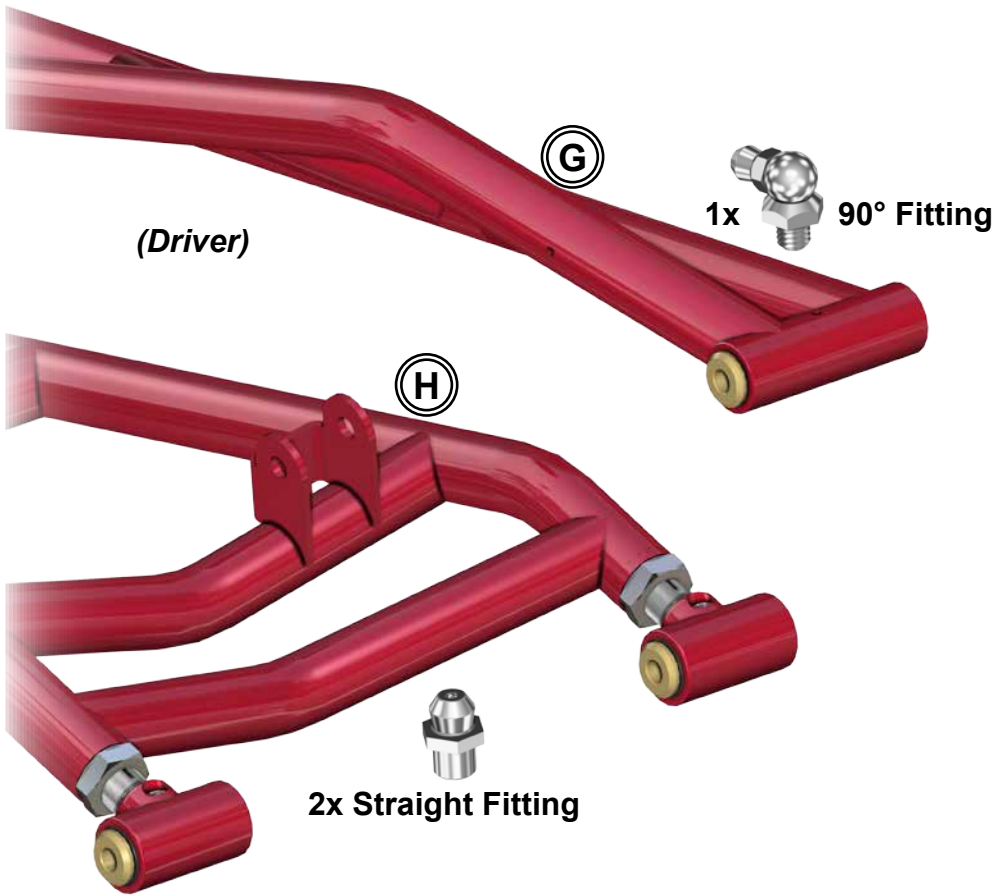

2016+ models:

Holes shown in Lower A-Arms must be drilled to Ø12mm to accept larger stock bolt.

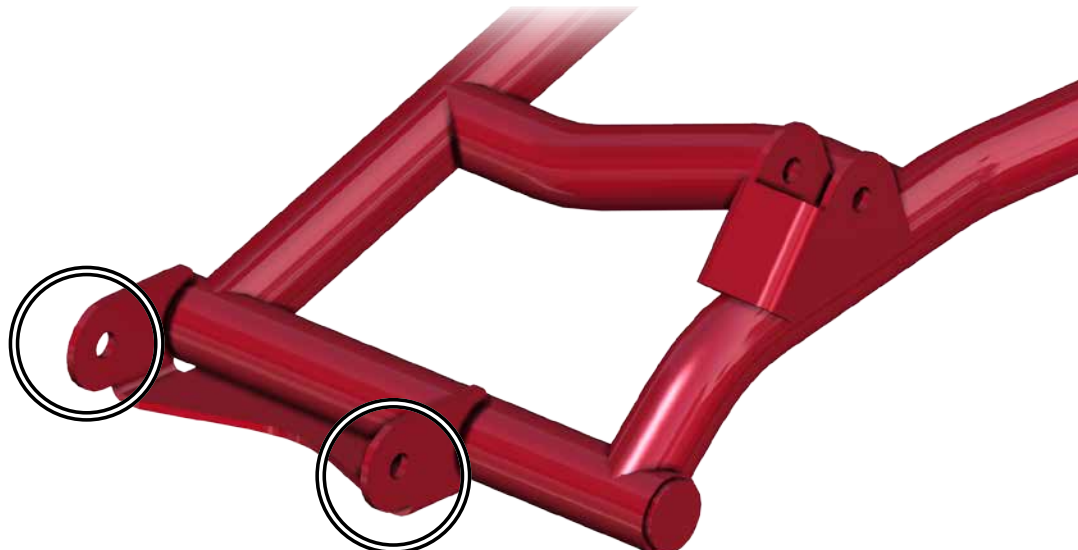

PIVOT BLOCK SETTINGS

- Place new A-Arms onto a flat surface and verify dimension shown.
- *Negative 1° camber setting is achieved when Pivot Blocks are set to this dimension.*
- See last page for additional camber information.

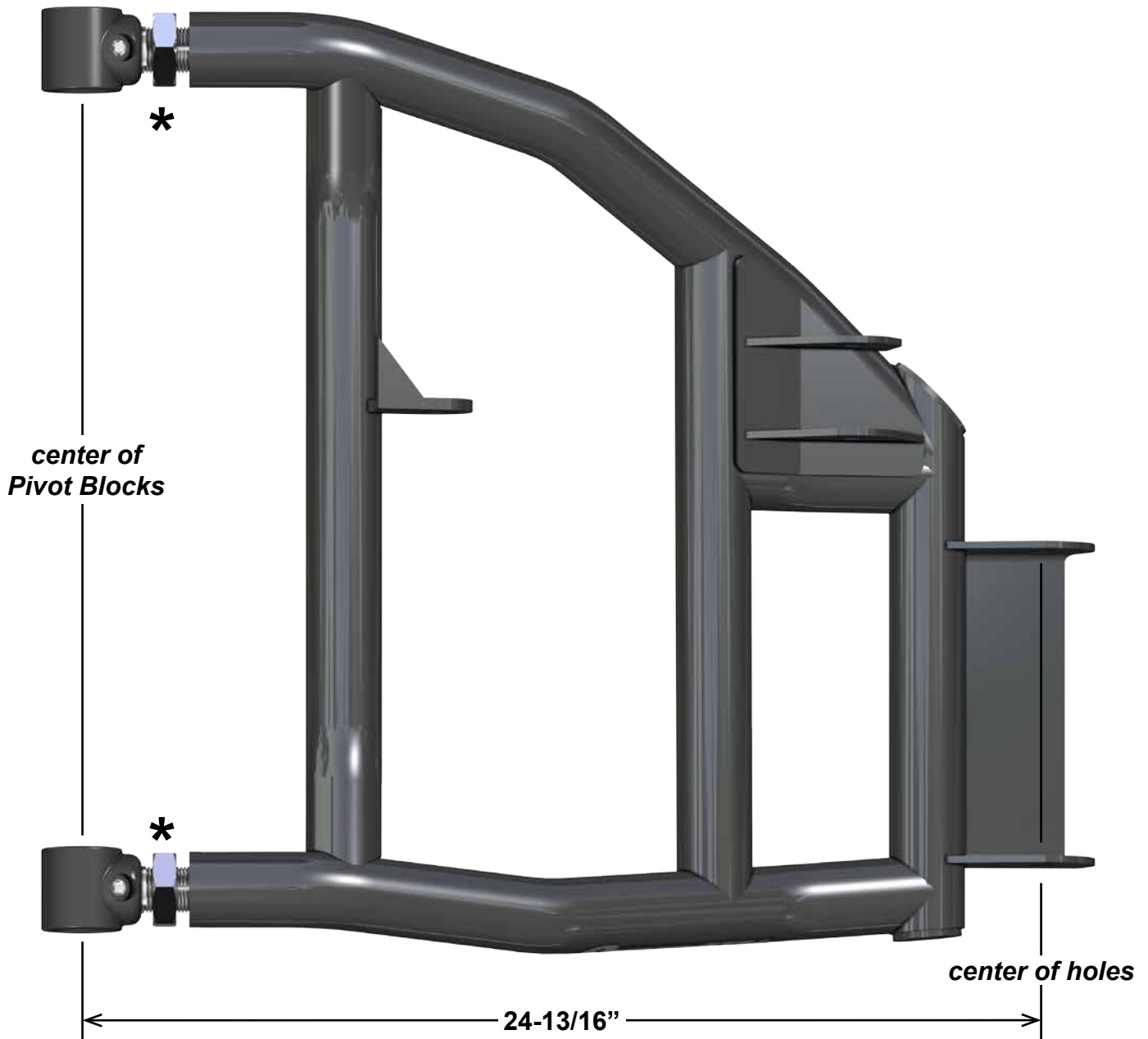

*** Leave Jam Nuts loose. Tighten after final adjustments have been made.**

Rear Installation: *Do not tighten hardware completely until last step.*

- Install Upper A-Arms (E)(G) to Frame with stock hardware; SuperATV recommends using thread locker on nuts.
- Install *front* portion of Lower A-Arms (F)(H) with stock hardware and supplied Pivot Bushing Spacer.
- Secure *rear* portion of Lower A-Arms (F)(H) with hardware shown; **do not add M10-1.50 Nylock Nut at this time.**

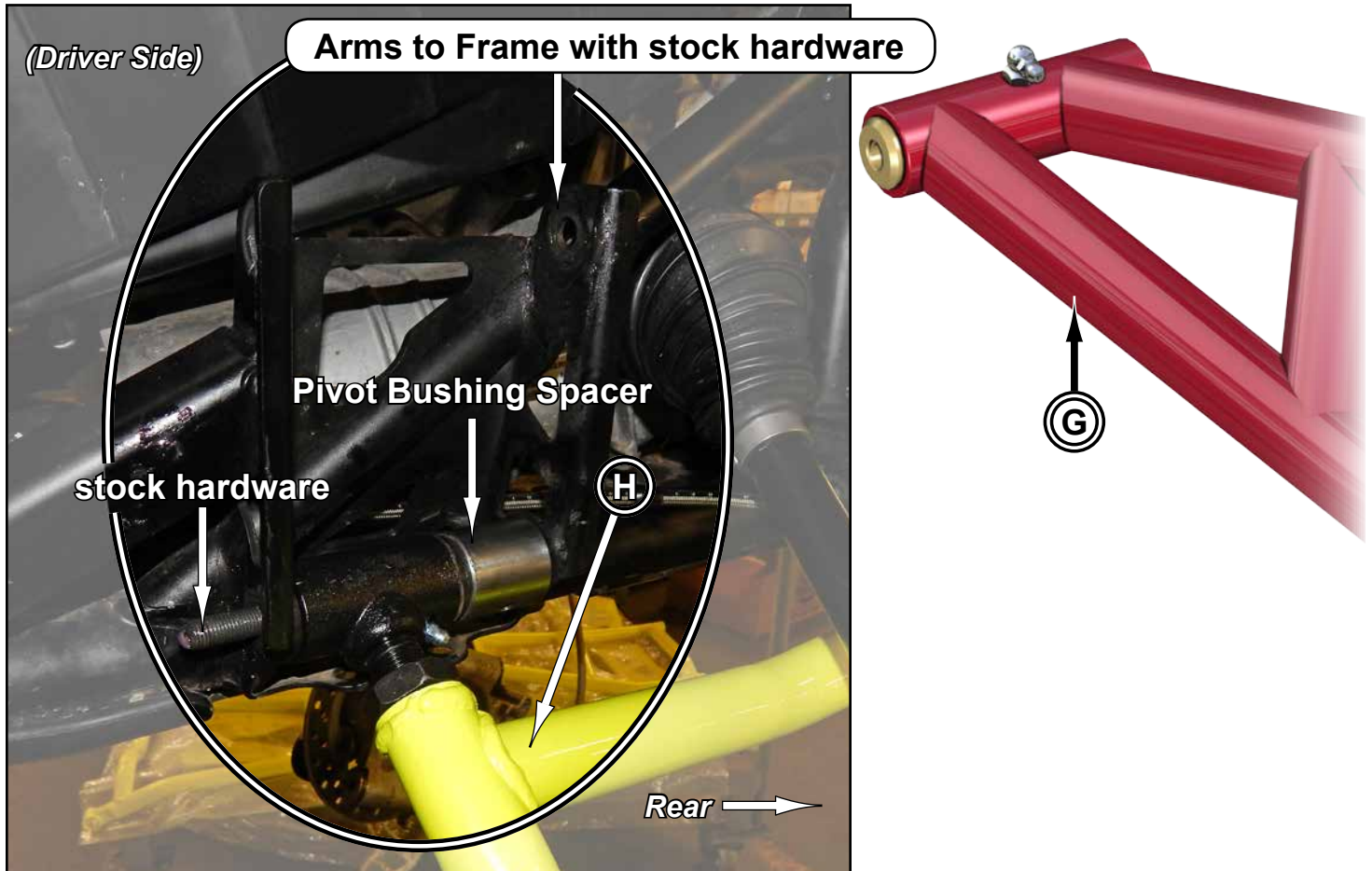

Rear Installation continued: *Do not tighten hardware completely until last step.*

- Install Shock Bracket Base, Left (L) into stock Shock Mount with stock Shock hardware.

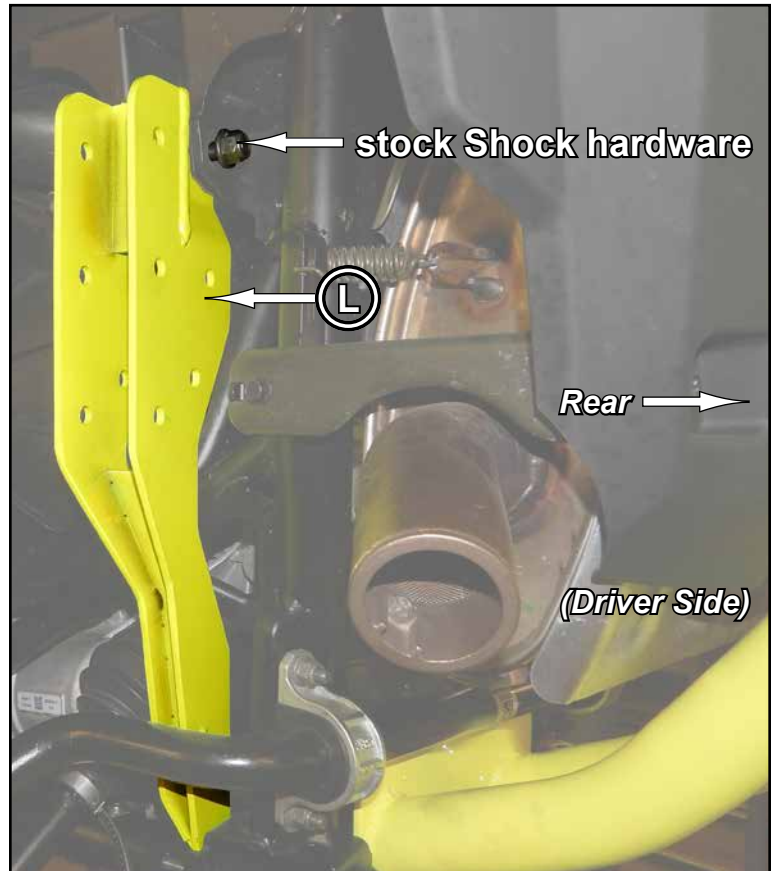
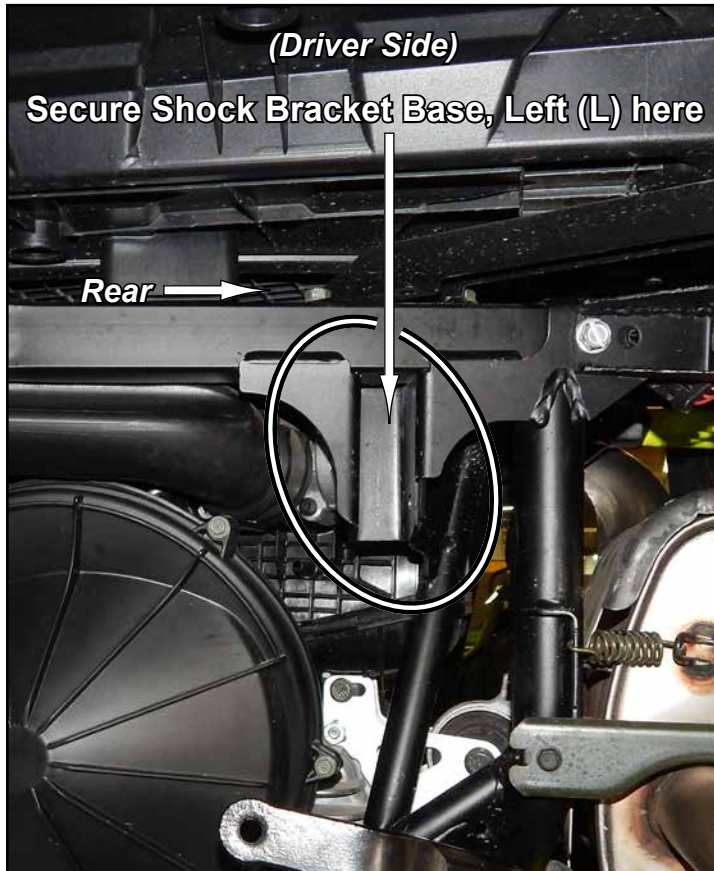

- Place lower hole in Shock Bracket Base, Left (L) onto previously installed hardware and secure with M10-1.50 Nylock Nut.

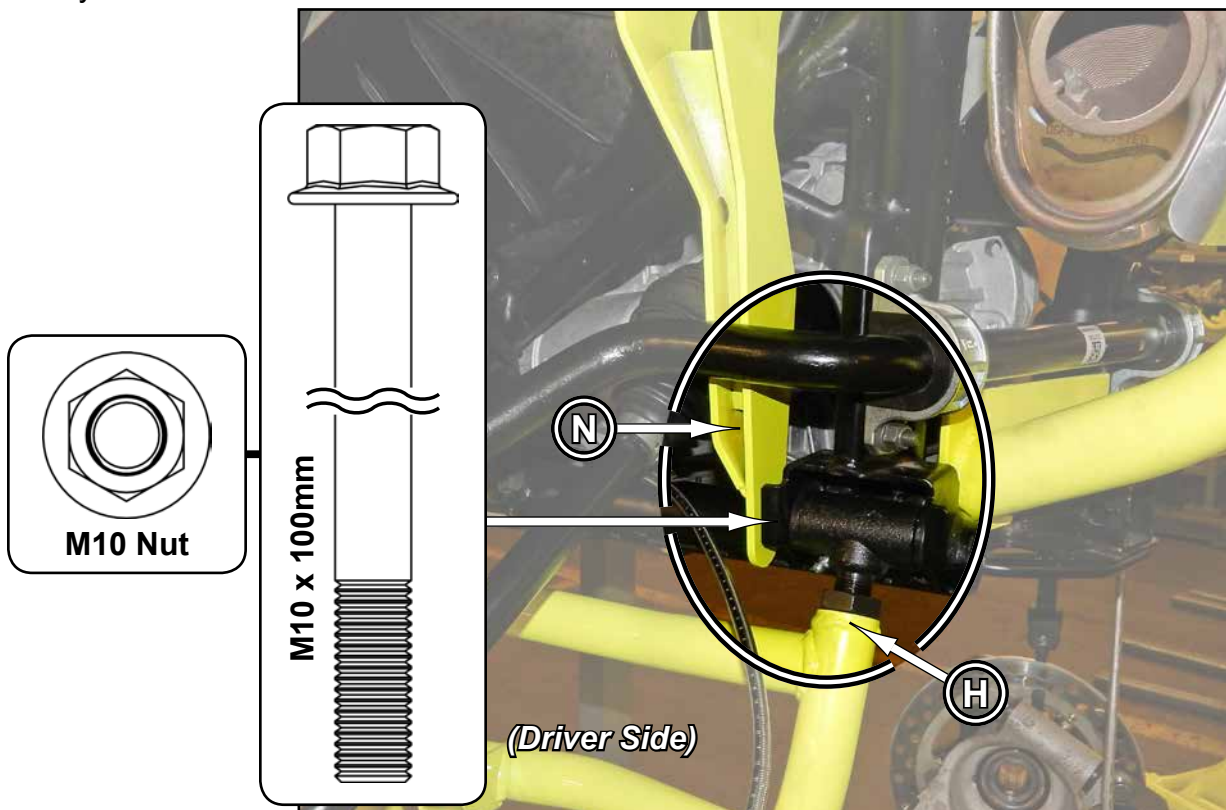

Rear Installation continued: Do not tighten hardware completely until last step.

- Insert Rear Shock Bracket Brace (K) through Frame from opposite side.



Rear Shock Bracket Brace (K) must be inserted through Frame before both Shock Bracket Bases (L-M) are installed.

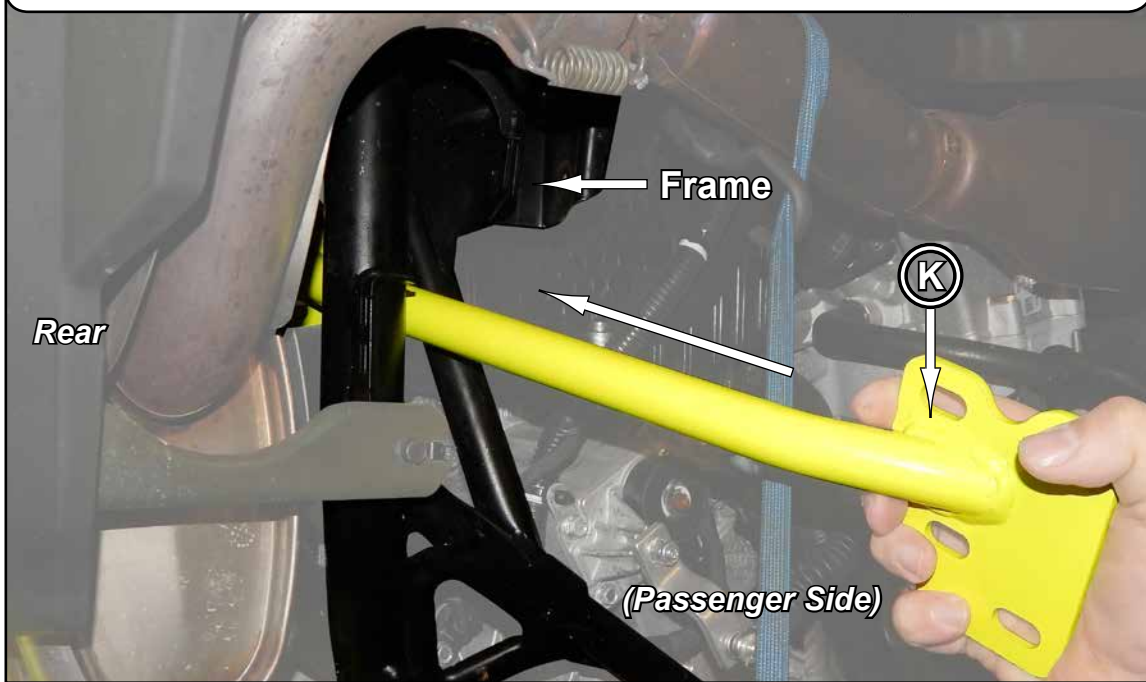

- Install Shock Bracket (N) into Shock Bracket Base, Left (L).
- Secure Shock Bracket (N), Shock Bracket Base, Left (L), and Rear Shock Bracket Brace (K) with hardware shown.
- Repeat for Shock Bracket Base, Right (M).

PARTS REFERENCE

Item	Description
K	Rear Shock Bracket Brace
L	Shock Bracket Base, Left
M	Shock Bracket Base, Right
N	Shock Brackets

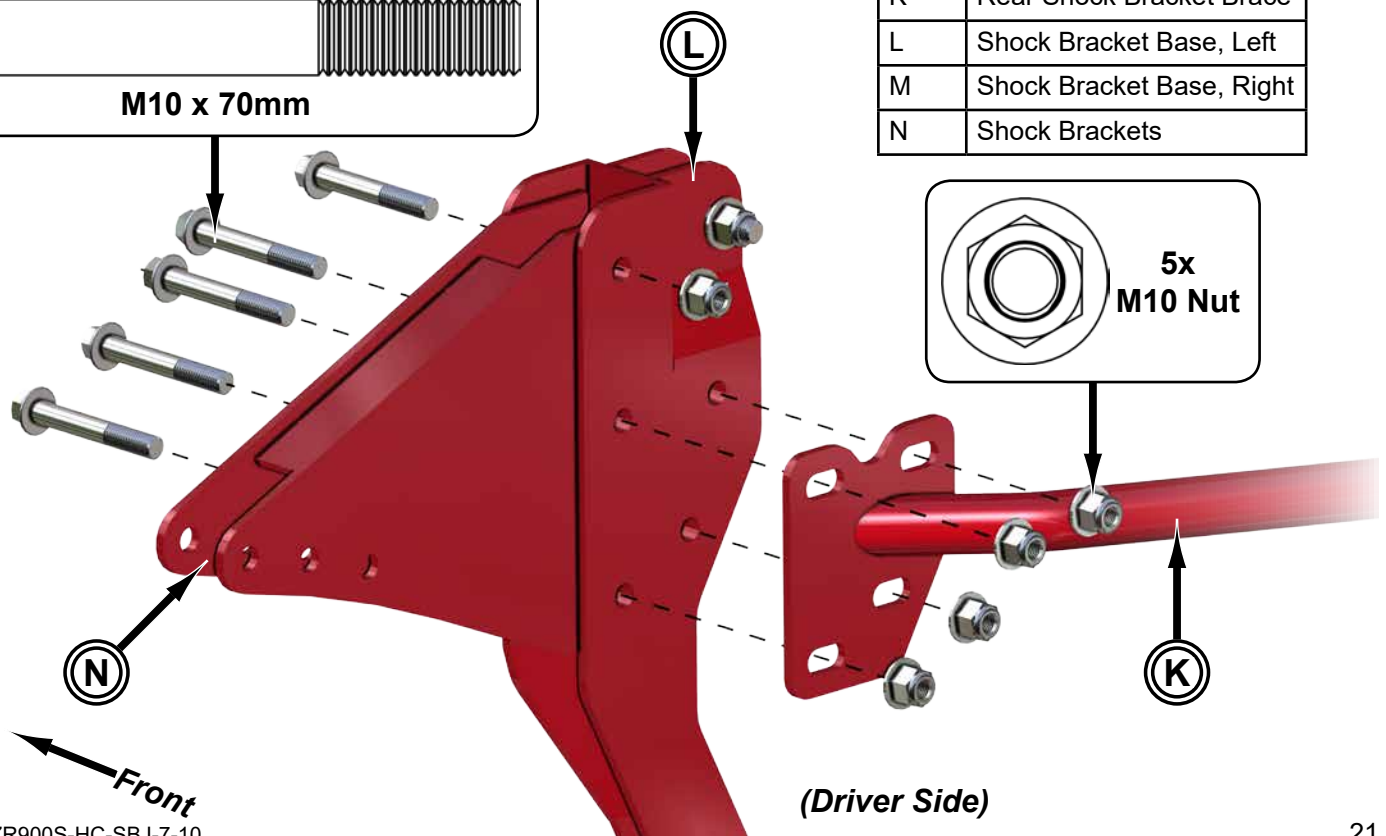
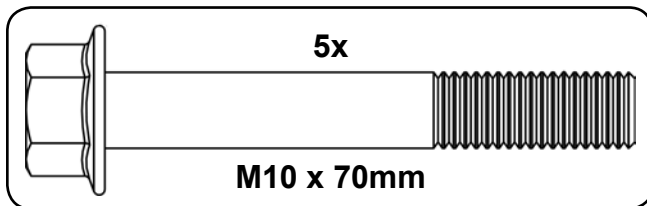

Rear Installation continued: *Do not tighten hardware completely until last step.*

- Install new Axles.
- **900 models:** Install Sway Bar (Q) and Bushings with stock hardware and components.
- Reinstall Calipers, Hubs, Knuckles, etc.
- Connect Sway Bar Links to Lower A-Arms (F)(H) and Sway Bar with stock hardware.
- Determine desired amount of lift and install Shocks with hardware shown.
- Install Brake Lines (P), **see following page.**

PARTS REFERENCE

Item	Description
E	Upper A-Arm, Passenger
F	Lower A-Arm, Passenger
G	Upper A-Arm, Driver
H	Lower A-Arm, Driver
Item	Description
K	Rear Shock Bracket Brace
L	Shock Bracket Base, Left
M	Shock Bracket Base, Right
N	Shock Brackets

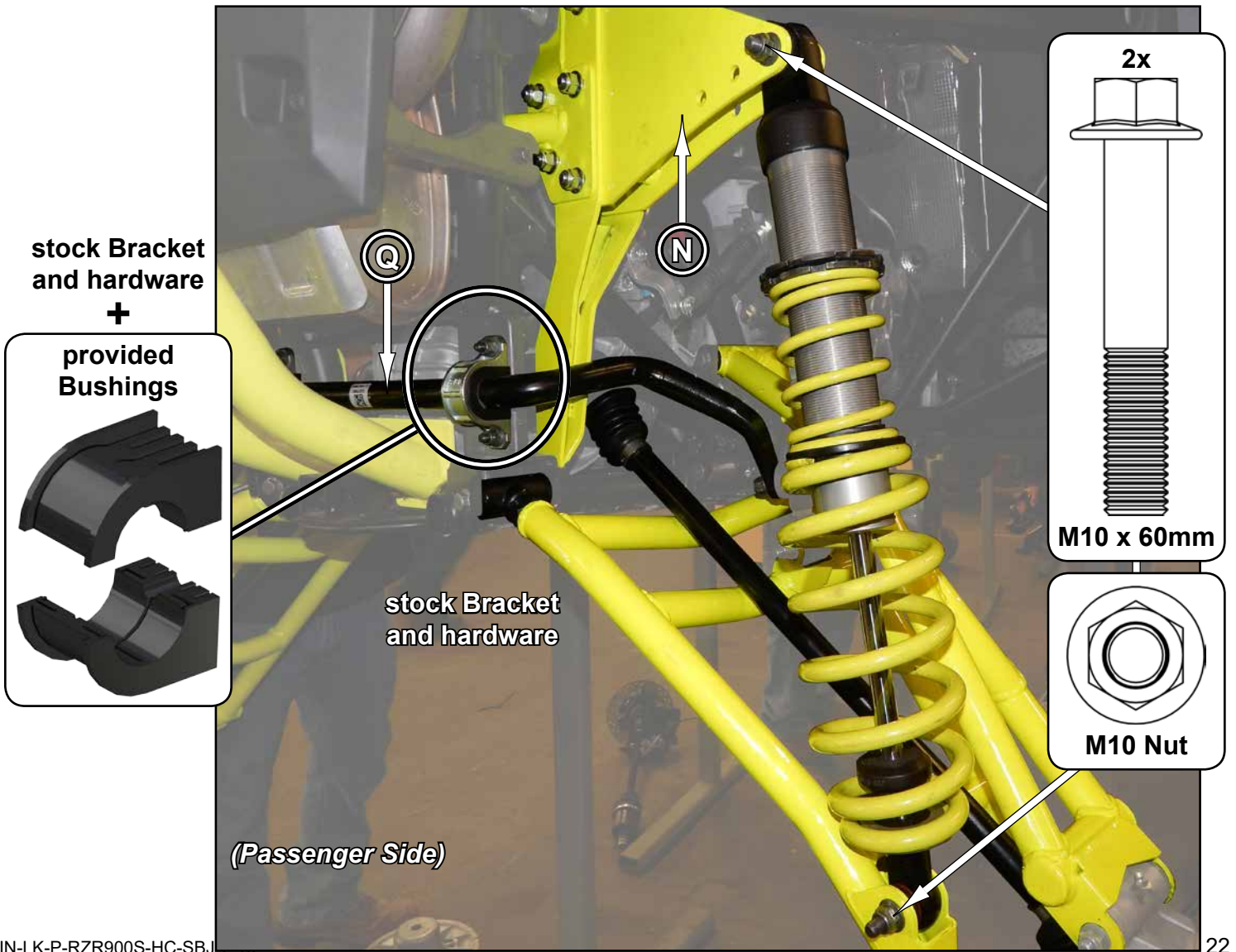
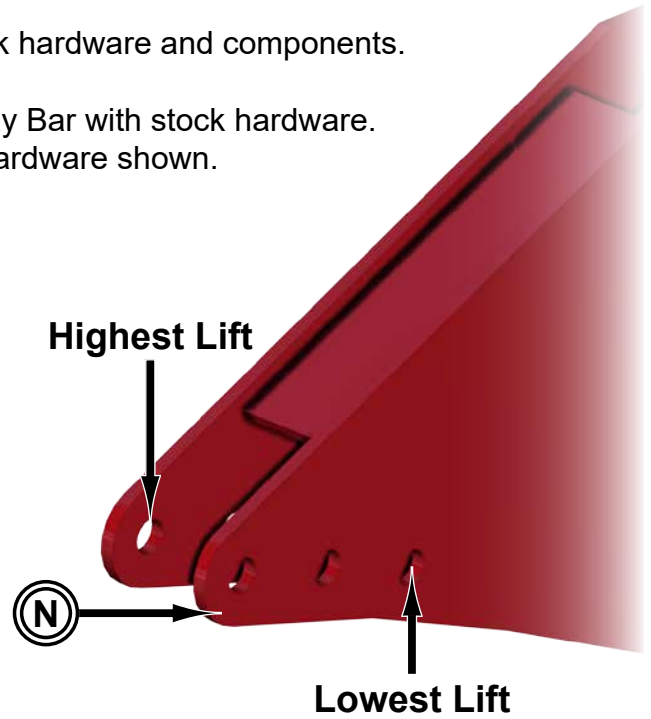

Rear Brake Line (P) Installation:

- Secure to A-Arms (E)(G) with Brake Line Clamps and hardware shown. Ensure no binding or interference can occur when in use.

secure Brake Lines to Upper A-Arms with (3) each

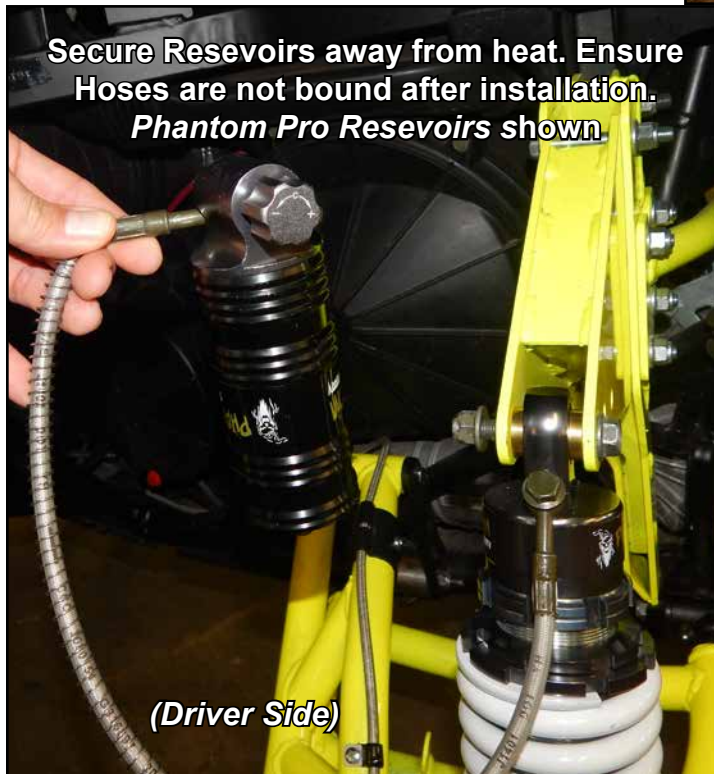
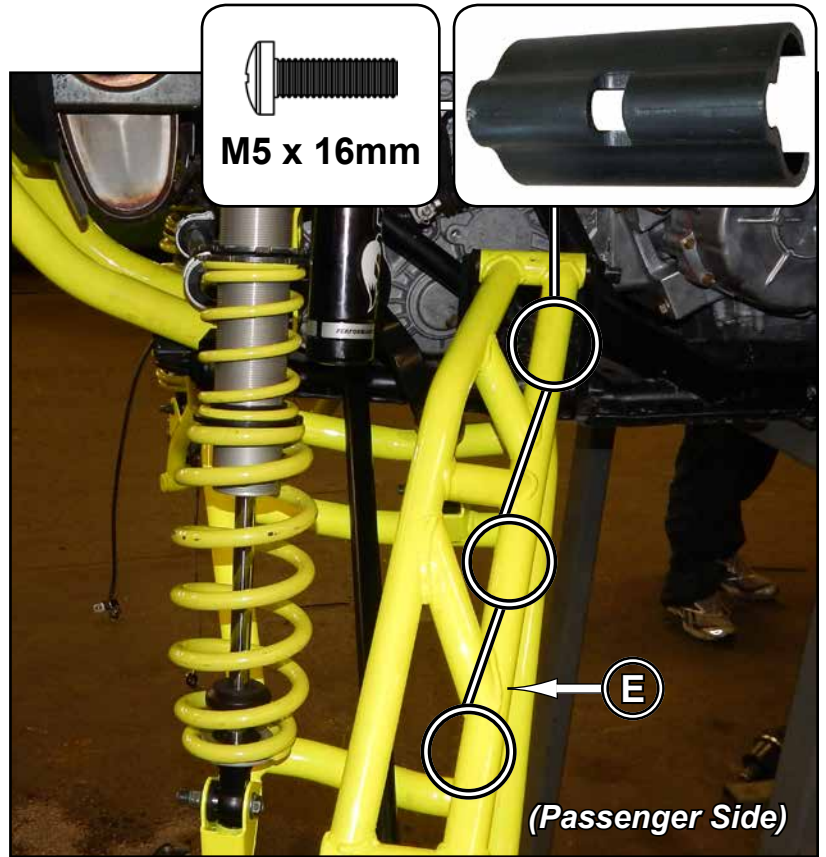

- Reinstall Tires and check Camber settings; see last page.
- Add Nuts to previously installed hardware and tighten completely. SuperATV recommends using Loc-Tite on Nuts.

CAMBER

- Tires must have equal air pressure before making adjustments.
- Adjustments to be made after all suspension components have been completely assembled.
- Tires must not be in contact with ground when making adjustments.
- Perform adjustments in small increments.



Adjusting Camber:

- Remove A-Arms from Frame and turn Pivot Blocks to adjust camber. Reinstall Arms.
- Lower machine and settle suspension components by rolling machine back and forth several feet at a time.
- Check settings and make small adjustments as needed.
- Each time an adjustment is made, machine must be rolled back and forth to settle suspension components.
- Once desired setting is achieved, tighten hardware completely. Loc-tite on Nuts is recommended.

A NEGATIVE CAMBER SETTING OF 1° to 2° IS RECOMMENDED.

LOWER:

Too much positive camber: adjust Pivot Blocks **OUT**.

Too much negative camber: adjust Pivot Blocks **IN**.

note: 2 full turns is 1°

UPPER A-ARMS:

Too much positive camber: adjust Pivot Blocks **IN**.

Too much negative camber: adjust Pivot Blocks **OUT**.

note: 2 full turns is 1°

