



INSTALLATION INSTRUCTIONS
2016 KAWASAKI TERYX / TERYX 4
FULL MULTIVENTS WINDSHIELD
PART # 77-8400

IMPORTANT NOTICES

READ AND UNDERSTAND THESE INSTRUCTIONS COMPLETELY BEFORE INSTALLATION TO AVOID INJURY TO YOURSELF, DAMAGE TO THE VEHICLE OR ACCESSORY.

- For proper installation, **TWO** people are required.
- Torque specifications must be followed when tightening bolts. Over-tightening any and/or all screws will cause cracks around mounting holes which is not covered by any warranty.
 - As specified on carton label, once protective film on shields is removed, product cannot be returned.
- As specified on carton label, damage caused by packaging staples is not covered by warranty. All staples must be removed prior to removing product from carton.
- Failure to follow these installation instructions completely may void any warrantable components and result in product damage or personal injury.
- Do not use Loctite or any other similar fastener adhesive. These types of products react to plastics and cause cracking. Not covered by any warranty.
- Our windshields are made from the highest quality material providing optimum transparency and clarity. Blurriness and/or extrusion marks may or may not appear when looking through windshield from a wide, side-angle. This is normal for all extruded clear plastic materials.
- The application of improper cleaners, abrasive and/or dirty cleaning towels can severely damage the product. Failure to follow cleaning recommendation (provided herewith) may void any warrantable components.

DEALER

These instructions contain important information for future reference and must be given to the customer at time of purchase or upon completion of installation.

Parts List (parts available with kit only and not available separately)

ITEM	PART NAME	DESCRIPTION	QTY
A	Windshield	CNC windshield cut-out made of 1/4" thick GE MR10 polycarbonate or equivalent	1
B	Co-extruded bulb seal	Includes: 54" Co-extruded bulb seal [end user to cut to exact length]	1
C	Upper vent grill	CNC vent grill cut-out made of 3/16" tinted polycarbonate	2
D	Lower vent grill	CNC vent grill cut-out made of 3/16" black polyethylene	2
INSTRUCTION BAG	E	Flop clamp set Includes: 2 flop clamps, 2 rubber strip pads 3/32", 2 rubber strip pads 3/16", 2 philips truss head screws M6 x 20 and 2 plastic shoulder washers M6	3
	F	Vent hardware Includes: 8 carriage bolts M6 x 30, 8 thin plastic washers, 16 plastic washers M6, 8 rubber washers M6 and 8 female thread knobs M6	1

1. Installation

- a) Find a clean flat area where you can safely lay down the windshield (Item A). Partially remove the protective film on both sides and apply the co-extruded bulb seal (Item B) to the lower edge using manual pressure to ensure good adhesion and cut any excess.

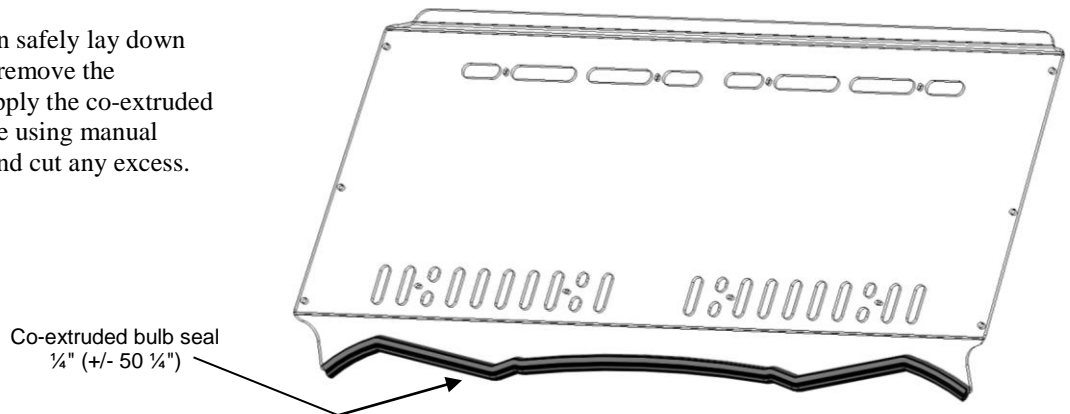

IMPORTANT NOTICES

Over-tightening any and/or all screws will cause cracks around mounting holes which is not covered by any warranty.

- b) Find a clean flat area where you can safely lay down the windshield. Partially remove the protective film on both sides and install the vent grills (Item C & D) using supplied hardware (Item F) as shown.

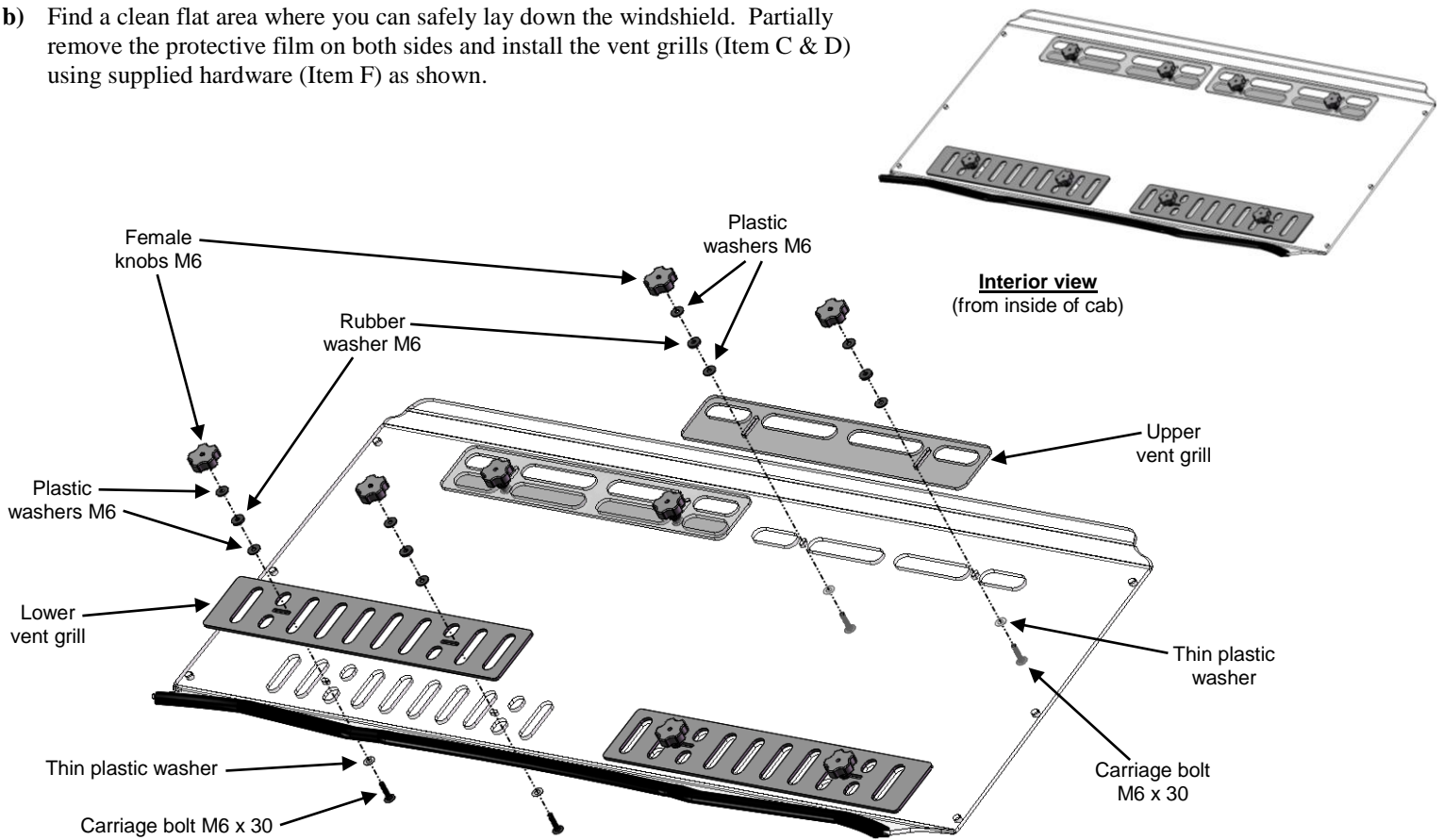

- c) **Verify "Rubber strip" chart.** If required, peel and stick the rubber strips to clamps (Items E) as shown below. Different thicknesses of rubber strips are supplied with the clamp kits in order to fit multiple tube sizes. Make sure that the proper one is used. See chart indicating which rubber strip to use for the different tube sizes. **The roll-cage tube size of your vehicle is 1 7/8".**

RUBBER STRIP SELECTOR CHART	
ROLL BAR / ROPS DIAMETER	RUBBER STRIPS TO INSTALL
2" (2.000")	Not applicable
1 7/8" (1.875")	3/32" (0.094")
1 3/4" (1.750")	3/16" (0.188")

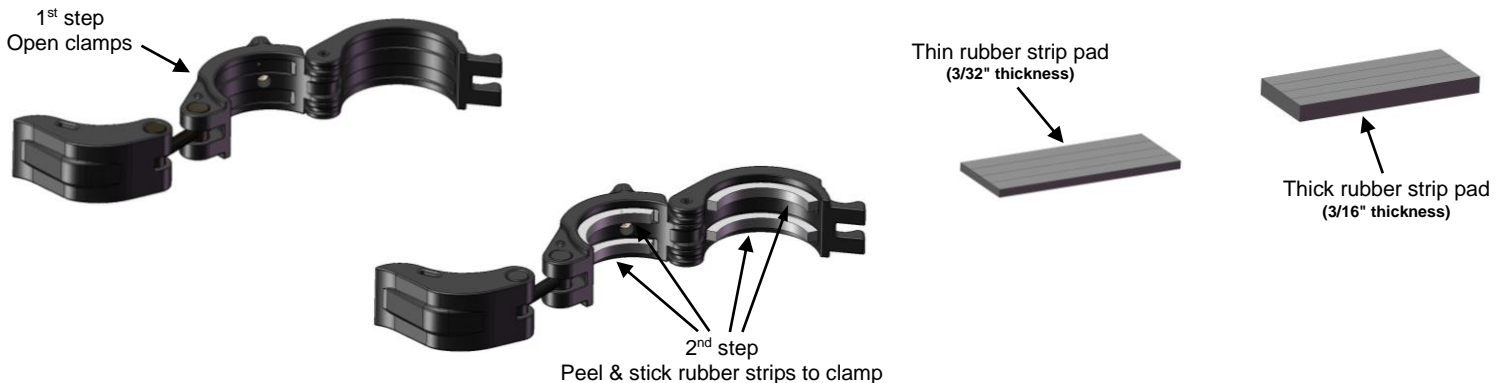

IMPORTANT NOTICES

Over-tightening any and/or all screws will cause cracks around mounting holes which is not covered by any warranty.

- d) Attach the clamps to the roll-cage as shown below and pre-adjust tightening tension of all clamps. **NOTE: Keep all clamp handles open as shown in step 3 below; this will allow you to move the clamps up or down when installing the windshield for the first time.**

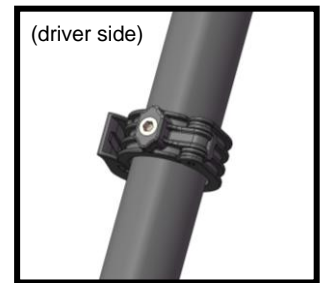
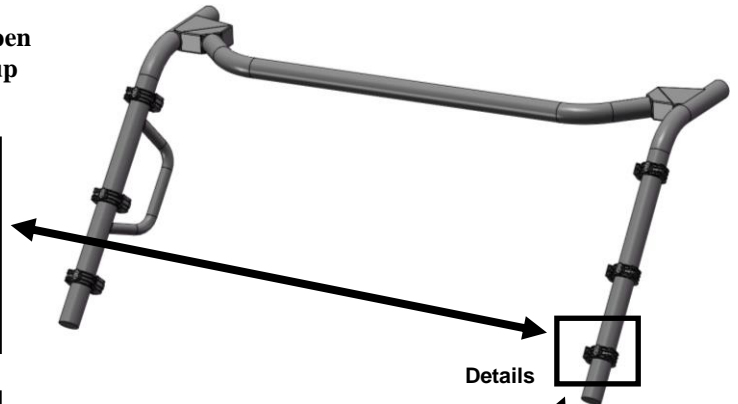
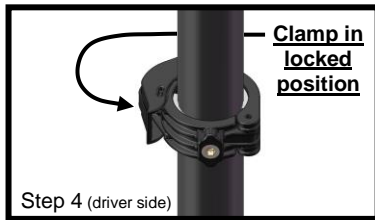
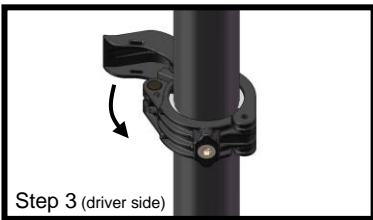
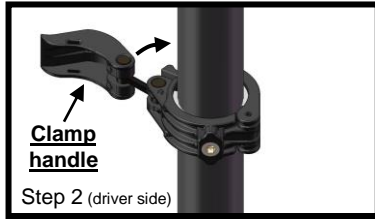
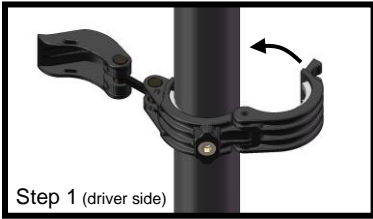

To apply more or less tension to the roll cage, simply rotate the clamp handle from the tension screw as shown below. Over tightening clamps to roll-cage could cause parts failures.

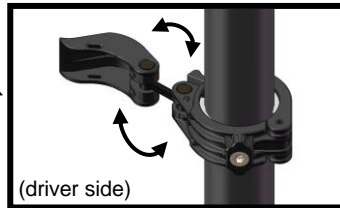

- e) Install windshield to the clamps using supplied screws and washers without applying final torque. Ensure that the windshield and all clamps are properly positioned. Secure all clamps in locking position [Ref: Step 4 - section d] and tighten all screws as shown below.

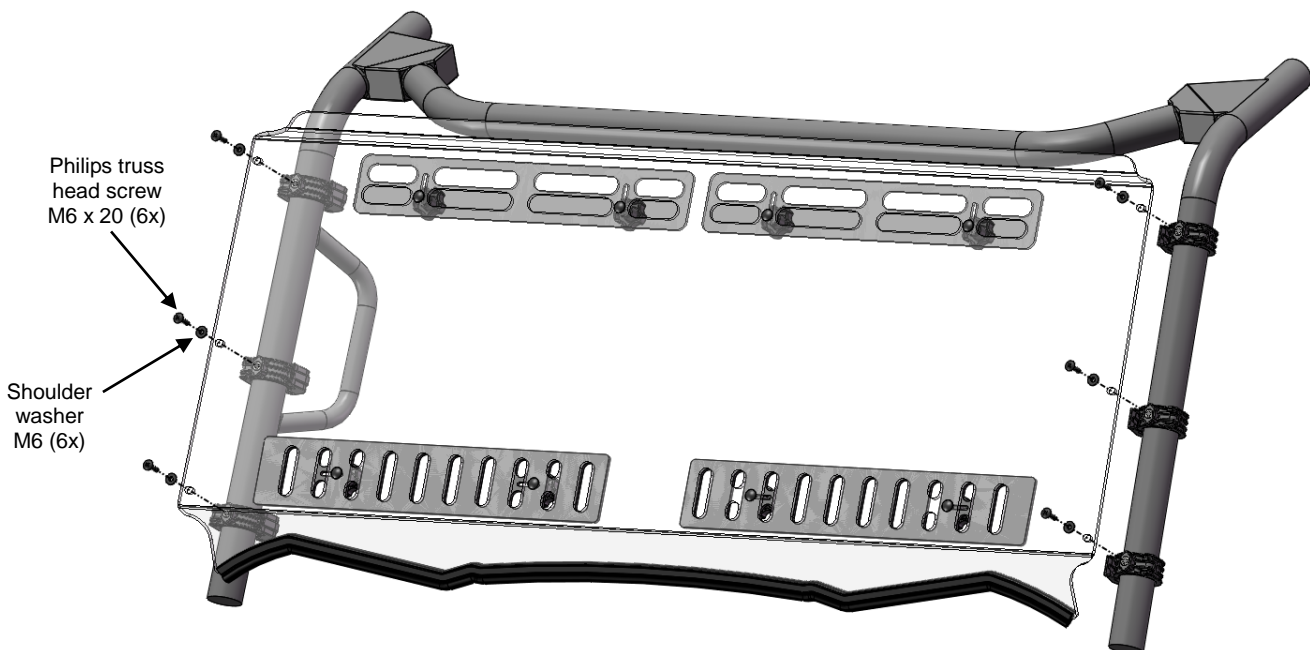

IMPORTANT NOTICES

Over-tightening any and/or all screws will cause cracks around mounting holes which is not covered by any warranty.

View of windshield
Assembled and installed



2. Maintenance and Care

Tighten all hardware after first use and periodically thereafter.

CLEANING:

- Rinse with lukewarm water; wash gently with mild soap or detergent and lukewarm water, using a soft cloth or sponge. **DO NOT SCRUB** or use brushes or squeegees.
 - Rinse again. Dry with soft cloth or moist cellulose sponge to prevent water spotting.
- To remove wet paint, glazing compound or grease, rub lightly with a good grade of VM&P naphtha or isopropyl alcohol, then wash and rinse. **DO NOT USE GASOLINE.**

NOTICE: Abusive cleaning procedures by hand washing or automated washing equipment will eventually result in visual hazing, loss of light transmission and coating delamination.

Compatible Cleaning Agents

- Aqueous Solution of Soaps and Detergents

Fantastik | Joy | Formula 409 | Mr. Clean | Top Job | VM&P grade Naphtha | Hexcel, F.O. 554 | Neleco-Placer