



INSTALLATION & OPERATIONS MANUAL FOR REAR VIEW MIRROR

**SPIKE REAR VIEW MIRROR
31003 - PRO-FIT CLAMP
31004 - DEFENDER CLAMP**

PARTS LIST:

- A. Mirror assembly
- B-1. Pro-Fit Clamp Bracket A
- B-2. Can Am Defender Clamp Bracket A
- C. Pro-Fit Clamp Bracket B
- D. Mirror Arm assembly
- E. M8 x 20mm button head bolt
- F. M8 x 25mm socket head bolt
- G. Color decal set (x6 colors)

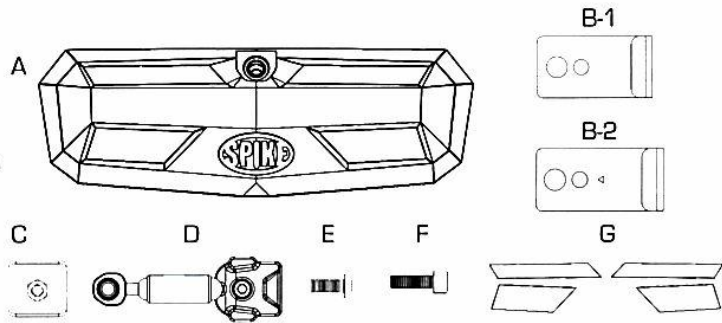

DECAL APPLICATION

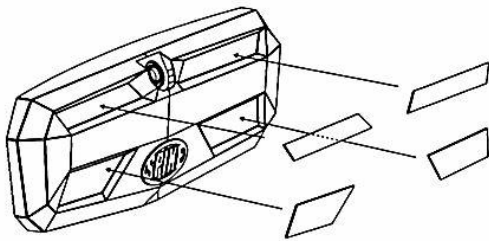

Choose preferred decal color. Detach the decal from backing. Apply them on the decal slots of mirror housing.

INSTALLATION: For Full & Mid-sized Rangers with Pro-Fit Roll Cage

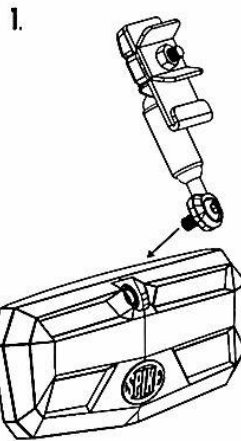

Screw Mirror Arm into Mirror using M8x20mm button head bolt.

2.

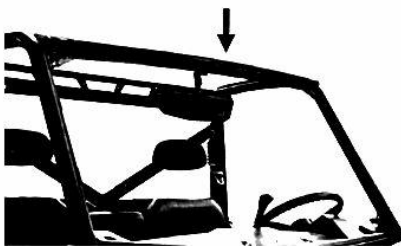

The Pro-Fit mirror clamp mounts to the middle of the bent sheet metal cross bar.

3. Front of Vehicle →

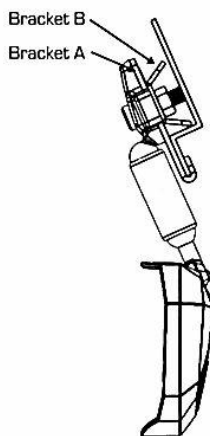

Place Pro-Fit clamp bracket A and B on the bent sheet metal middle cross bar as shown.

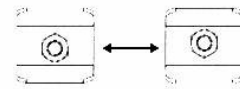

Clamp Bracket B has 2 mounting orientations. If not tight enough, flip bracket 180 degrees and tighten.

4.

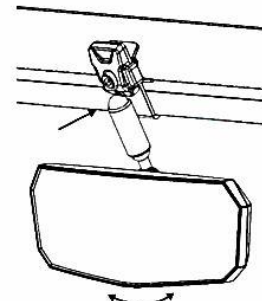

Line up the mirror with arm attached and install using M8 x 25mm socket head bolt. Adjust mirror as necessary.