

elluminate™

CONNEXT  
GARDEN LIGHTING SYSTEM

# HOW DOES YOUR GARDEN **GLOW?**

COMPLETE YOUR GARDEN  
LIGHTING IN **3 EASY STEPS**

[www.elluminatelighting.com.au](http://www.elluminatelighting.com.au)



IT IS AMAZING HOW STUNNING YOUR GARDEN CAN LOOK WITH THE ADDITION OF A FEW WELL PLACED LIGHTS.



elluminate™

CONNEXT  
GARDEN LIGHTING SYSTEM

THE GARDEN HAS BECOME SYNONYMOUS WITH RELAXATION AND SOCIALISING. THE OUTDOOR LIVING SPACE IS BECOMING AS IMPORTANT AS THE INDOOR LIVING ROOM.



**A great custom lighting system starts with great planning.**

Discover the elluminate range for a selection of garden and outdoor lighting.

Create your custom garden lighting design with our easy to install 'CONNEXT Plug n Play System'.

Make a statement in your garden by highlighting waterfeatures or statues. Deck lights define entertaining areas while providing both atmosphere and safety. Spotlights amongst greenery and bollard lights dotted along pathways create a welcoming ambiance and showcase your garden beautifully.

**KEY FEATURES**

- Safe 12V System
- Energy Efficient LED
- Replaceable Globes
- No Tools Required
- No Electrician Costs
- Simple 'Plug n Play' Setup
- Robust Cable & Connection
- All lights include Base & Spike

HOW DOES YOUR GARDEN **GLOW?**

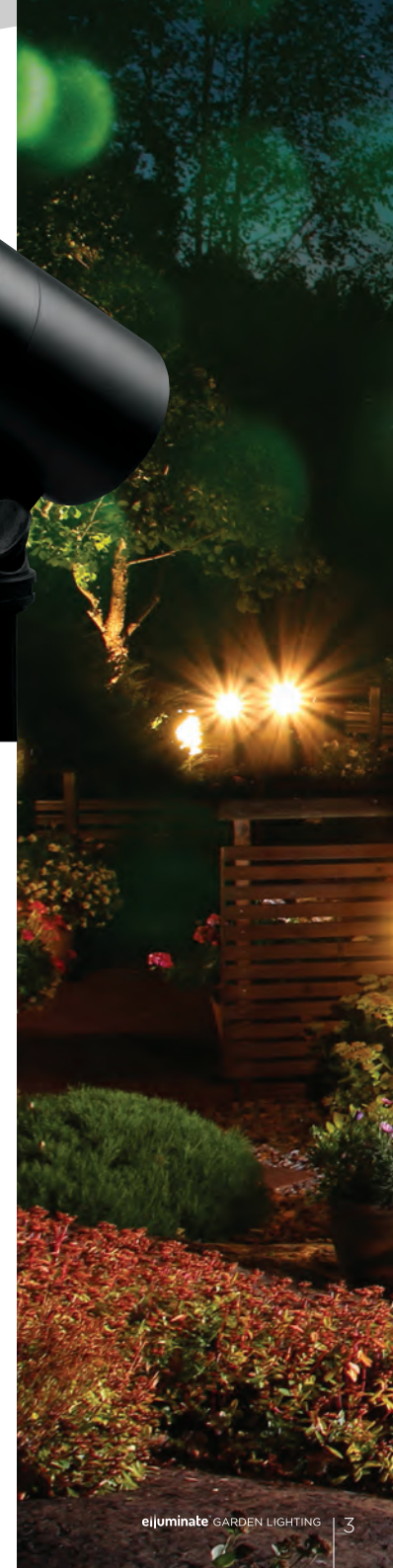



CONNEXT IS  
A PLUG N PLAY  
GARDEN LIGHTING  
SYSTEM THAT  
IS SO SIMPLE.

**CONNEXT**  
GARDEN LIGHTING SYSTEM

Whenever you see the CONNEXT logo you know this item will be compatible with your system.



### COMPLETE YOUR GARDEN LIGHTING IN 3 EASY STEPS



**SELECT YOUR LIGHTS**

Any style or size  
MAX 12 LIGHTS PER TRANSFORMER



**CHOOSE YOUR CONNECTORS & CABLES**

Various lengths  
MAX 50M PER TRANSFORMER



**GRAB A TRANSFORMER**

Plug in and enjoy  
IT'S THAT SIMPLE

elluminate removes the hard work, headache and installation costs from your garden lighting project.

Using our simple '3 Step Process' you can light your entire garden quickly and easily with no tools or specialist knowledge required; in fact your kids could even do it for you.

It is a completely safe low voltage system with easy 'Plug & Play' weatherproof connectors.

You will have impressive custom garden lighting that will last you for years. Better still, you can take it with you if you ever relocate.

HOW DOES YOUR GARDEN **GLOW?**





IDEAL FOR ILLUMINATING WATERFEATURES, PLANTS, SHRUBS, ORNAMENTS & TREES.

2W SMALL GARDEN SPOTLIGHT  
20EL062

3W LARGE GARDEN SPOTLIGHT  
20EL063



**STEP 1 - SELECT YOUR LIGHTS**

**GARDEN SPOTLIGHT**

WARM WHITE / 2W LED (SMALL) / 3W LED (LARGE)



	2W SPOTLIGHT	3W SPOTLIGHT
<b>Power</b>	2W	3W
<b>Nominal Voltage</b>	12V	12V
<b>Globe type</b>	LED MR11	LED MR16
<b>Lumens</b>	750 LUMENS	810 LUMENS
<b>Cable Length</b>	0.5m	0.5m
<b>Construction</b>	Black plastic housing	Black die-cast housing
<b>Package contents</b>	1 x Light fixture with base & plastic spike 1 x Globe	1 x Light fixture with base & plastic spike 1 x Globe
<b>Requires</b>	12V transformer <small>(not included in pack and sold separately)</small>	12V transformer <small>(not included in pack and sold separately)</small>
<b>Adjustable head</b>	Yes	Yes
<b>Product code</b>	20EL062	20EL063

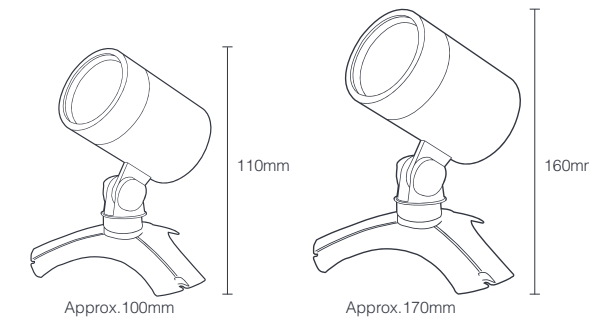

Available as a Starter Kit

Includes: 4 x Small Spotlights, 1 x Transformer, 1 x 10m Cable, 3 x 1m Cable, 3 x T-Piece Connectors

Product Code 20EL201





PERFECT FOR  
 ILLUMINATING  
 PATHWAYS, PLANTS  
 AND SHRUBS.

3W  
 BLACK  
 GARDEN  
 BOLLARD  
 20EL082

3W  
 S/STEEL  
 GARDEN  
 BOLLARD  
 20EL081



STEP 1 - SELECT YOUR LIGHTS

# GARDEN BOLLARD

WARM WHITE / BLACK / STAINLESS STEEL / 3W LED



	3W BOLLARD BLK	3W BOLLARD S/S
<b>Power</b>	3W	3W
<b>Nominal Voltage</b>	12V	12V
<b>Globe type</b>	LED MR16	LED MR16
<b>Lumens</b>	40 LUMENS	40 LUMENS
<b>Cable Length</b>	0.5m	0.5m
<b>Construction</b>	Black coated housing	Stainless Steel housing
<b>Package contents</b>	1 x Light fixture with base & metal spike 1 x Globe	1 x Light fixture with base & metal spike 1 x Globe
<b>Requires</b>	12V transformer <small>(not included in pack and sold separately)</small>	12V transformer <small>(not included in pack and sold separately)</small>
<b>Product code</b>	20EL082	20EL081

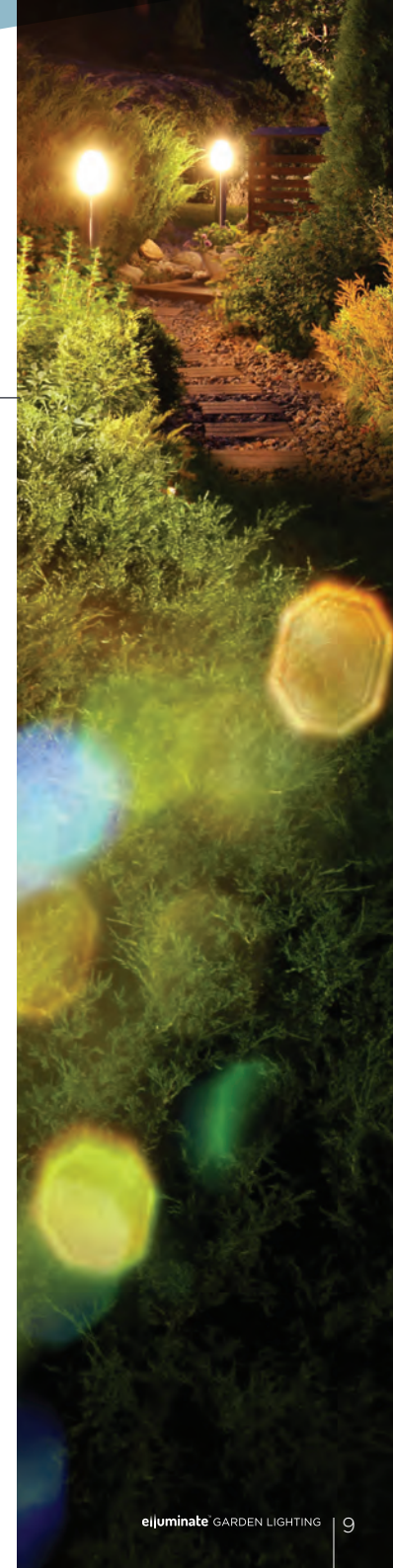
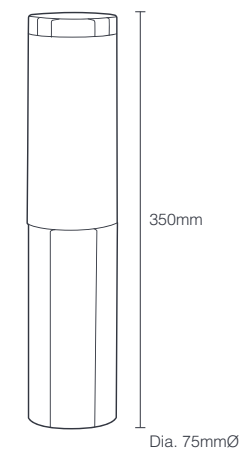
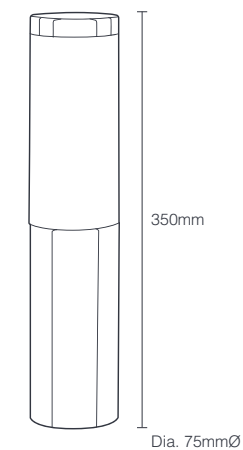





**STEP 1 - SELECT YOUR LIGHTS**

**DECK LIGHT**

WARM WHITE / 1W LED (PACK 4) / 2W LED (LARGE)



IDEAL FOR LIGHTING  
 DECK AREAS, PATIOS,  
 AND STEPS FOR  
 STYLE & SAFETY.  
 CAN BE MOUNTED  
 BOTH VERTICALLY &  
 HORIZONTALLY.

**2W  
 LARGE  
 DECK  
 LIGHT**  
 20EL092

**1W SMALL  
 PACK 4  
 DECK  
 LIGHTS**  
 20EL091

	<b>1W DECK LIGHT</b>	<b>2W DECK LIGHT</b>
<b>Power</b>	1W	2W
<b>Nominal Voltage</b>	12V	12V
<b>Globe type</b>	LED Non-replaceable	LED MR11
<b>Lumens</b>	420 LUMENS	840 LUMENS
<b>Cable Length</b>	0.2m	0.2m
<b>Construction</b>	Stainless Steel housing Heavy Duty Glass lens	Stainless Steel housing Heavy Duty Glass lens
<b>Package contents</b>	4 x Light fixture with base & plastic spike 4 x Globe	1 x Light fixture with base & plastic spike 1 x Globe
<b>Requires</b>	12V transformer <small>(not included in pack and sold separately)</small>	12V transformer <small>(not included in pack and sold separately)</small>
<b>Hole required</b>	28mm Ø	44mm Ø
<b>Product code</b>	20EL091	20EL092

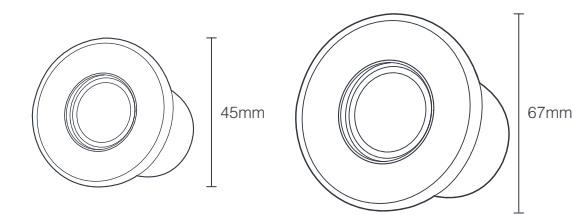

**Available as a  
 Starter Kit**

Includes: 4 x 1W Deck Lights, 1 x Transformer, 1 x 10m  
 Cable, 3 x 1m Cable, 3 x T-Piece Connectors

**Product Code** 20EL200





1M / 2M / 5M / 10M  
 EXTENSION CABLE  
 21EC001 / 21EC002 / 210EC005 / 21EC010



T-PIECE  
 CONNECTOR  
 21EC003



COMPLETE YOUR  
 CUSTOM GARDEN  
 LIGHTING DESIGN  
 WITH OUR EASY  
 TO INSTALL 'PLUG  
 N PLAY' WIRING &  
 CONNECTORS.



**STEP 2 - CHOOSE CONNECTORS & CABLES**

**CABLES & CONNECTORS**

1M / 2M / 5M / 10M CABLES / T-PIECE CONNECTOR



**EXTENSION CABLE**

Length	1m / 2m / 5m / 10m
UV Resistant	Yes
Material	PVC
Outdoor Use	Yes
Cable Diameter	1mm <sup>3</sup>
Product Code	1m - 21EC001
	2m - 21EC002
	5m - 21EC005
	10m - 21EC010

**T-PIECE CONNECTOR**

UV Resistant	Yes
Material	Plastic
Outdoor Use	Yes
Connections	1 Male / 2 Female
Product Code	21EC003

NOW COMES THE **EASY BIT.**





**STEP 3 - GRAB A TRANSFORMER**

# OUTDOOR TRANSFORMER

72W / 6000MA TRANSFORMER



### EXTENSION CABLE

<b>Power</b>	72W / 6000 mA
<b>Output Voltage</b>	12V
<b>Input Voltage</b>	240V
<b>UV Resistant</b>	Yes
<b>Material</b>	Black plastic housing
<b>Outdoor Use</b>	Yes
<b>Cable Diameter</b>	1mm <sup>3</sup>
<b>Product Code</b>	21ET072

### ADDITIONAL EXTRAS

AUTOMATICALLY TURN YOUR LIGHTS ON AT NIGHT.

### AUTOMATIC LIGHT SENSOR

<b>Max Power</b>	100W
<b>Nominal Voltage</b>	12V
<b>UV Resistant</b>	Yes
<b>Material</b>	Black plastic housing
<b>Outdoor Use</b>	Yes
<b>Availability</b>	2018/19



**72W OUTDOOR TRANSFORMER**  
21ET072

UNIQUE 2 PIN CONNECTOR COMPATIBLE ONLY WITH ELLUMINATE CABLES AND LIGHTS.

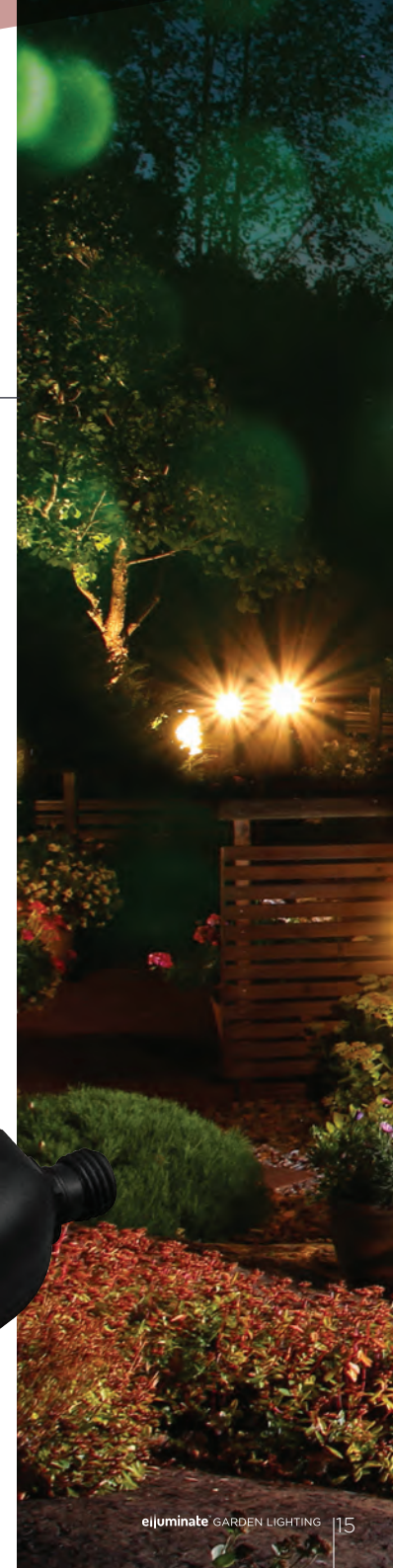





## WHERE DO I BEGIN?

**Walk your garden during the day and night to select key focal points and sketch a plan of the area.**

Add trees, shrubs, decks, and areas of any significance in the garden to your diagram.

**Don't forget to indicate where your power point is located.**

Think about what type of lights you would like to have in your garden. Choose from small spotlights to light up smaller plants or larger spotlights to highlight a beautiful tree. Bollard lights are a great addition to a driveway or path, and deck lights create a fantastic feature along the edges of decking or stairs.

Now you have your lights placed, it's time to work out your cables. Measure the distance between each light and back to your power source and write these measurements on your plan.

**You will need a T-Piece Connector for every light except the last light in your sequence. Indicate these on your plan.**

Now measure the distance from your power supply to the first light and mark this on your plan.

**Check the total length of all your cables does not exceed 50m.**

Once you're home, simply connect them all up, turn them on, sit back and enjoy. It's that simple.

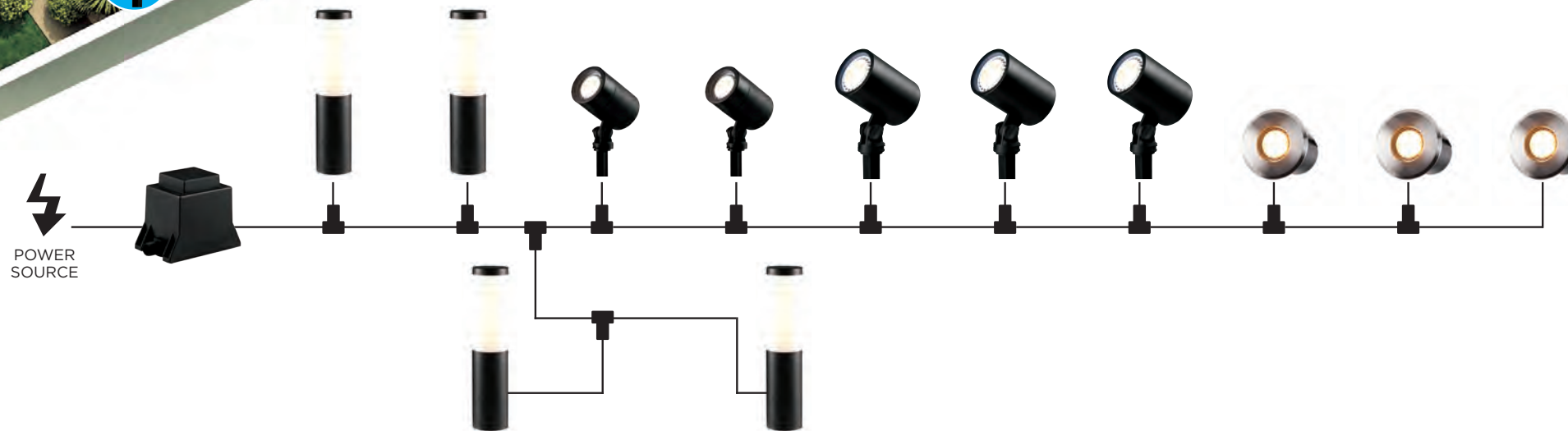

### WHAT WE USED

- Small Spot Light (x2)
- Large Spot Light (x3)
- Bollard Light (x4)
- Deck Light (x3)
- 1m Extension Cable (x7)
- 2m Extension Cable (x3)
- 5m Extension Cable (x2)
- 10m Extension Cable (x1)
- T-Piece Connectors (x11)
- 72W Transformer (x1)

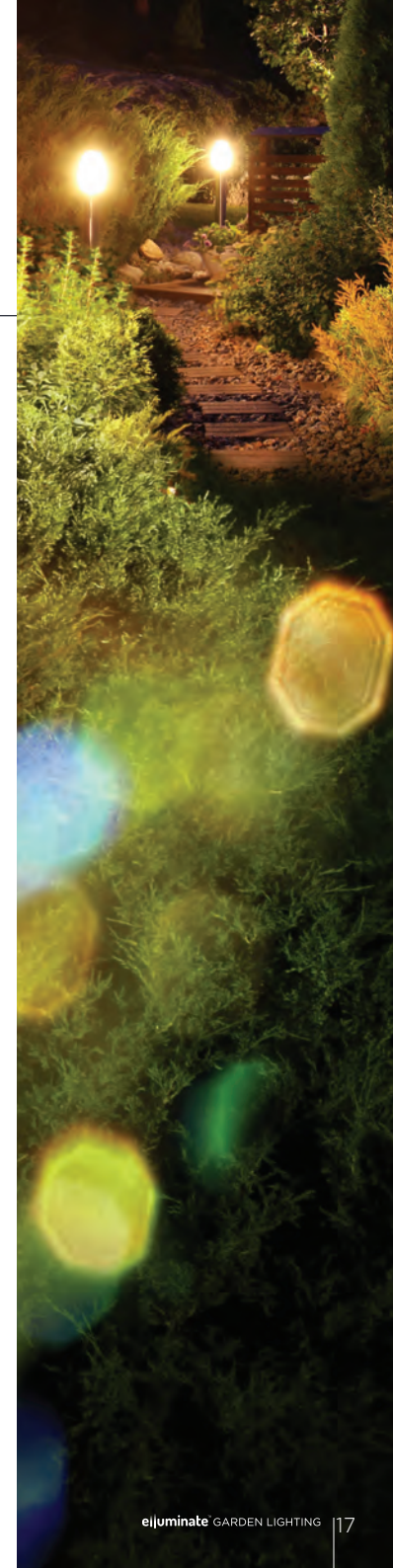





MAKE A START.

## PLAN YOUR PROJECT

COMPLETE YOUR GARDEN LIGHTING IN 3 EASY STEPS

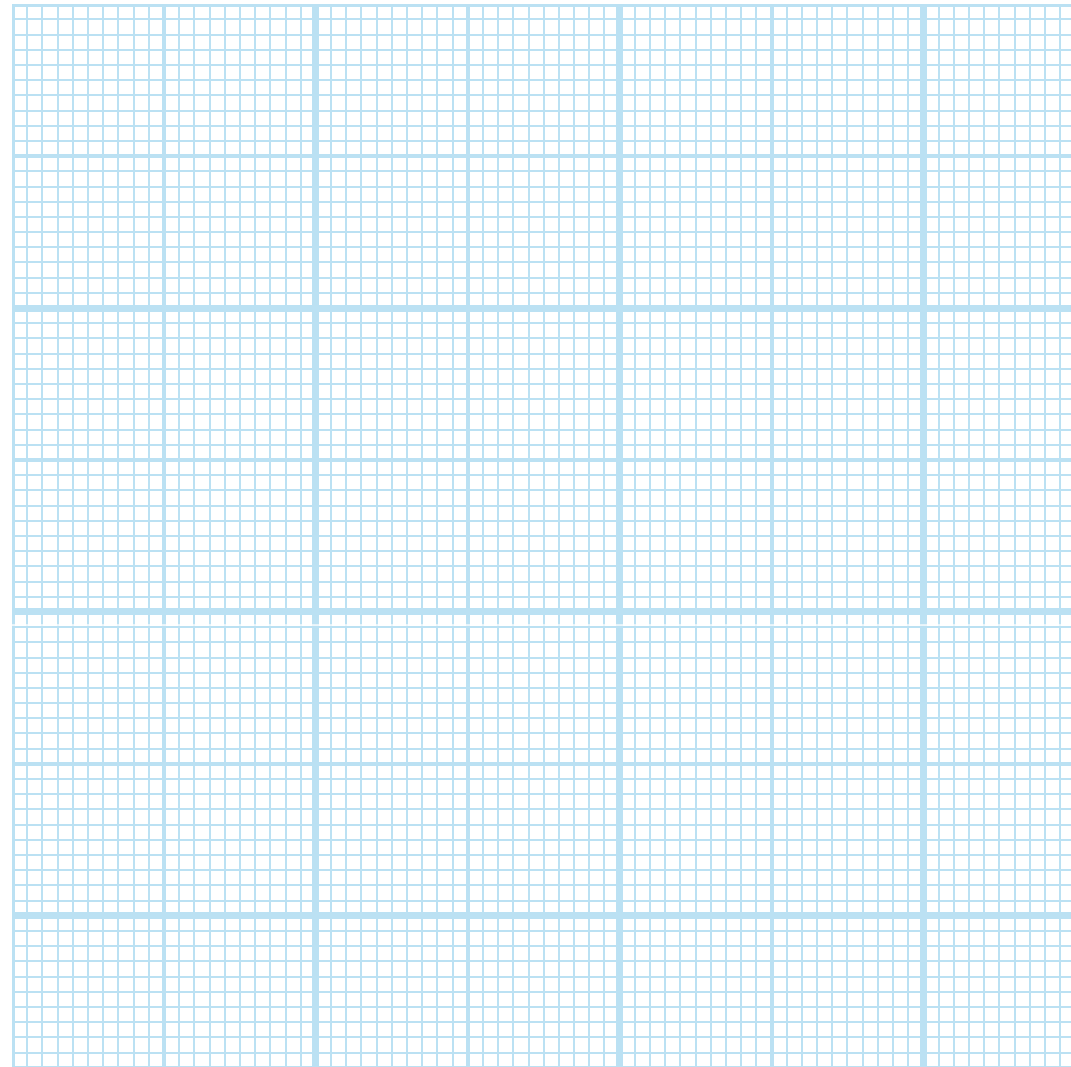

1CM = 2M

IT'S SO EASY.  
HOW DOES  
YOUR GARDEN  
GLOW?







elluminate™

HOW DOES YOUR GARDEN **GLOW**?

[WWW.ELUMINATELIGHTING.COM.AU](http://WWW.ELUMINATELIGHTING.COM.AU)

elluminate is a registered trademark of Aquatec Equipment  
37 Edison Circuit, Forrestdale WA 6112  
AUSTRALIAN OWNED COMPANY

Made in China exclusively for **elluminate**