

Arkal 3" Twin Lite Filter with a detachable spine

Catalog No. 014000-*****
Threaded BSPT
Threaded NPT
Victaulic
Arkal Flange

Features

- Inlet / Outlet options 3" - VIC, AR-Flange, Threaded
- Parts in contact with water are made of polypropylene
- Highly resistant to corrosion
- Detachable spine
- Pressure differential disc compression
- Available in various filtration grades
- Unique polymeric clamp
- Drain ball valve

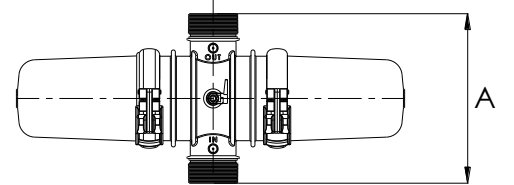
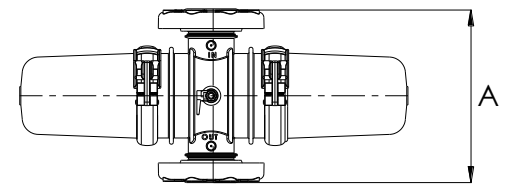
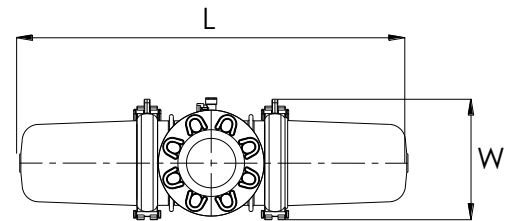

Technical Data

Inlet/Outlet diameter	3" Arkal Flange / Threaded / Grooved	
Max. Pressure	8 bar	116 psi
Max. Flow rate 400-100 micron	50 m ³ /h (13.9 l/sec)	220 gpm
70 micron	40 m ³ /h (11.1 l/sec)	176 gpm
55 micron	34 m ³ /h (8.9 l/sec)	150 gpm
20 micron	16 m ³ /h (4.4 l/sec)	70 gpm
Filtration area	1900 cm ²	294 in ²
Filtration volume	2450 cm ³	150 in ³
Filter width W	225 mm	8 27/32"
Filter length L	730 mm	28 3/4"
Distance between connections A	320 mm	12 19/32"
Weight (Victaulic, Threaded)	6.3 Kg	14 lbs
Weight (Flanged)	7.8 Kg	17 lbs
Maximum temperature	60° C	140° F
pH	2-13	

Filtration Grades

- 1 - Blue (400 micron / 40 mesh)
- 2 - Yellow (200 micron / 80 mesh)
- 3 - Red (130 micron / 120 mesh)
- 4 - Black (100 micron / 140 mesh)
- 5 - Brown (70 micron)
- 6 - Green (55 micron)
- 7 - Grey (20 micron)

Headloss Chart

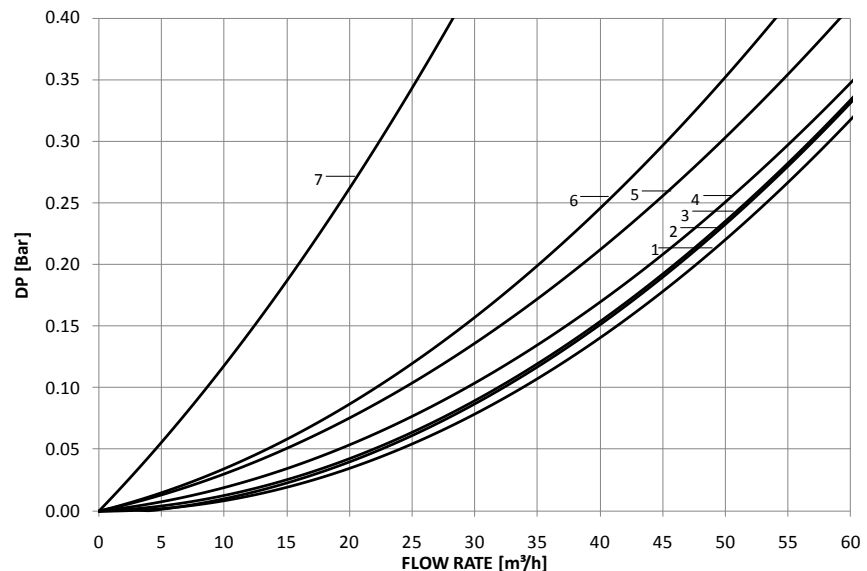

Installation Recommendations

FRONT VIEW

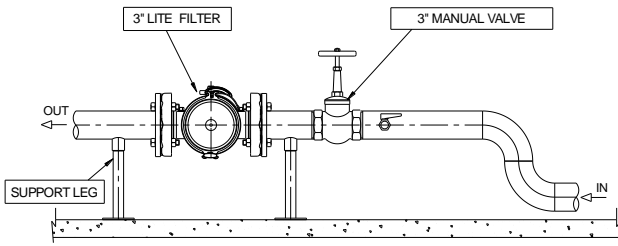

TOP VIEW

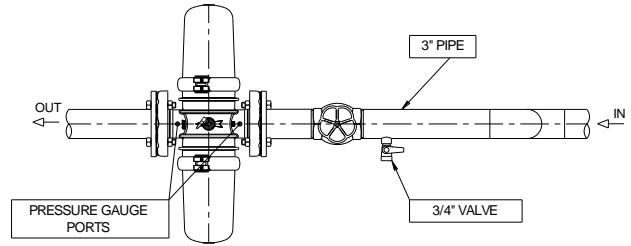

Dismantling

1. Turn off the water.
2. Release the pressure through the drainage ball valve.
3. Open the filter clamp and remove the cover.
4. Unscrew and remove the filter element.
5. Wash the filter element.
6. If the filter discs require acid treatment you may dip the complete filter element in acid according to our recommendation.

Assembly

1. Place the filter element, turn clockwise until secure. Verify that the filter element is tightened in place.
2. Place the cover and attach the clamp. Verify that the clamp is securely locked.

Winterization:

To prevent filter damage due to freezing water - drain all the water from the filter and leave the drain valve open.

Part List

No.	Cat. No.	Description	Materials
1	710101-000049	Filter cover	PP
2	770102-000048	O-ring 2-361(151.77x5.33)	EPDM
3	700190-000220	Clamp	RPA
4	700101-*****	Filter element *** Micron	PP
5	770104-000045	Gauge port seal	EPDM
6	710101-000148	Gauge port nut	RPP
7	730104-000217	1/2" ball valve	BRASS
8	700190-000114	Body + flanges Assembly	-
	700190-000108	Body grooved Assembly	-
	700190-000103	Body threaded BSPT Assembly	-
	700190-000104	Body threaded NPT Assembly	-
9	710101-000144	Ring flange 3"	RPA
10	710101-000135	Cone flange	POM
11	770104-000034	Gasket 3"	EPDM
12	700190-000223	Flange complete	-

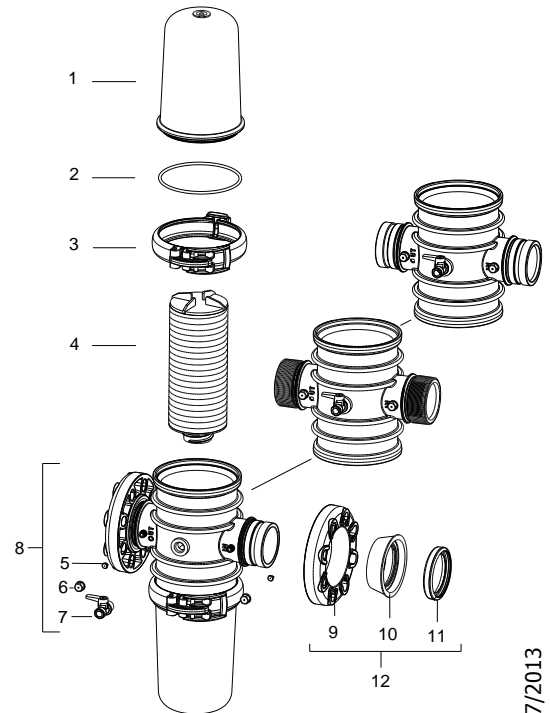

Materials

PP - POLYPROPYLENE

RPA - REINFORCED POLYAMIDE

RPP - REINFORCED POLYPROPYLENE

POM - ACETAL

Note:

- This filter is equipped with a pressure safety device. If pressure exceeds the maximum work pressure, the seal will act as a pressure release element. If such occurs, please open the clamp, place the seal on the cover and reassemble.
- Before opening the filter clamp, check that there is no pressure on the filter.

AMIAD LIMITED WARRANTY

This certificate applies to Amiad Products purchased by You from Amiad or an Amiad authorized Distributor (“**Distributor**”). This limited warranty extends only to the original purchaser, and is not transferable to anyone who subsequently purchases, leases, or otherwise obtains the Product from the original purchaser.

1. Amiad hereby warrants that the Products are and will be free from defects in material and workmanship under normal use and service. Amiad warrants that it will correct manufacturing defects in the Products, in accordance with the conditions set out in this warranty.
2. This warranty is enforceable for a period of 12 months after the date Bill of Lading or equivalent (the “**Warranty Period**”).
3. In the event that during the Warranty Period the Distributor discovers a defect in material and/or workmanship in any Product or part (the “**Defective Product**”), it shall submit a written complaint to Amiad using Amiad’s standard customer complaint form. For the receipt of the customer complaint form, the submission of the complaint or any questions please contact your customer service representative.
4. Upon written demand by Amiad the Distributor shall return the Defective Products – or a sample thereof – to Amiad, at Amiad’s cost. If the customer ships any such Product, Amiad suggests the customer package it securely and insure it for value, as Amiad assumes no liability for any loss or damage occurring during shipment. Provided however that in the event Amiad determines that the warranty does not apply to such Product, Distributor shall promptly reimburse Amiad for such cost (including freight and customs). Any returned Product or part must be accompanied by the warranty certificate and the purchase invoice. It is clarified that the Distributor may not return the Defective Product unless such return was coordinate and approved by Amiad in advance.
5. Amiad’s obligation under this warranty shall be limited to, at its option, the repair or exchange, free of charge, of the Product or any part which may prove defective under normal use and service during the Warranty Period. The provision of a repaired or replacement Product during the Warranty Period will result in an extension of the Warranty Period by an additional period of 12 months, provided that the total accumulated Warranty Period shall in any event be no more than 18 months from the original Bill of Lading.
6. This warranty is valid on the condition that the Products are installed according to Amiad’s instructions as expressed in Amiad’s instruction manuals and according to the technical limitations as stipulated in Amiad’s literature or as stated by a representative of Amiad.
7. This warranty will not apply to damaged or defective Products resulting from or related to:
 - (i) Fire, flood, power surges or failures or any other catastrophe/and or unforeseen occurrence, such as but not limited to those for which the customers are customarily insured;
 - (ii) Fault, abuse or negligence of the customer;
 - (iii) Customer’s responsibilities, including the failure of the intake water to meet the agreed standards, as set forth in a written document, approved by Amiad or improper storage.
 - (iv) Improper or unauthorized use of the Product or related parts by the customer, including the customer’s failure to operate the Product in conformity with the recommendations and instructions of Amiad, as set forth in Amiad’s manuals and other written materials, the operation of the Product other than by a trained and qualified operator, or improper installation of the Product by a third party not authorized by Amiad;
 - (v) Performance by the customer of maintenance and other services other than by a trained and qualified advanced operator, or other than in conformity with the recommendations and instructions of Amiad, or other than in accordance with procedures defined in the literature supplied for Products;
 - (vi) Any alteration, modification foreign attachment to or repair of the Products, other than by Amiad or its authorized technical representatives.
8. In no event shall Amiad be liable to the customer or any third party for any damages, including indirect, special, exemplary, punitive or consequential damages, or lost profits arising out of or in connection with this warranty, or arising out of or in connection with the Product’s performance or failure to perform, even if it has been advised of the possibility of such damages.
9. Amiad will be excused for failure to perform or for delay in performance hereunder if such failure or delay is due to causes beyond its reasonable control or force majeure preventing or hindering performance.
10. The limited warranty set forth herein is the only warranty given by Amiad and is provided in lieu of any other warranties created by any documentation, packaging or otherwise.
11. Amiad makes no warranty whatsoever in respect of accessories or parts not supplied by Amiad. In the event that Amiad is required to correct a defective Product or product not covered by this warranty, it will do so solely in consideration for additional fees.