

# 1999 Miata With Stock Or AGX

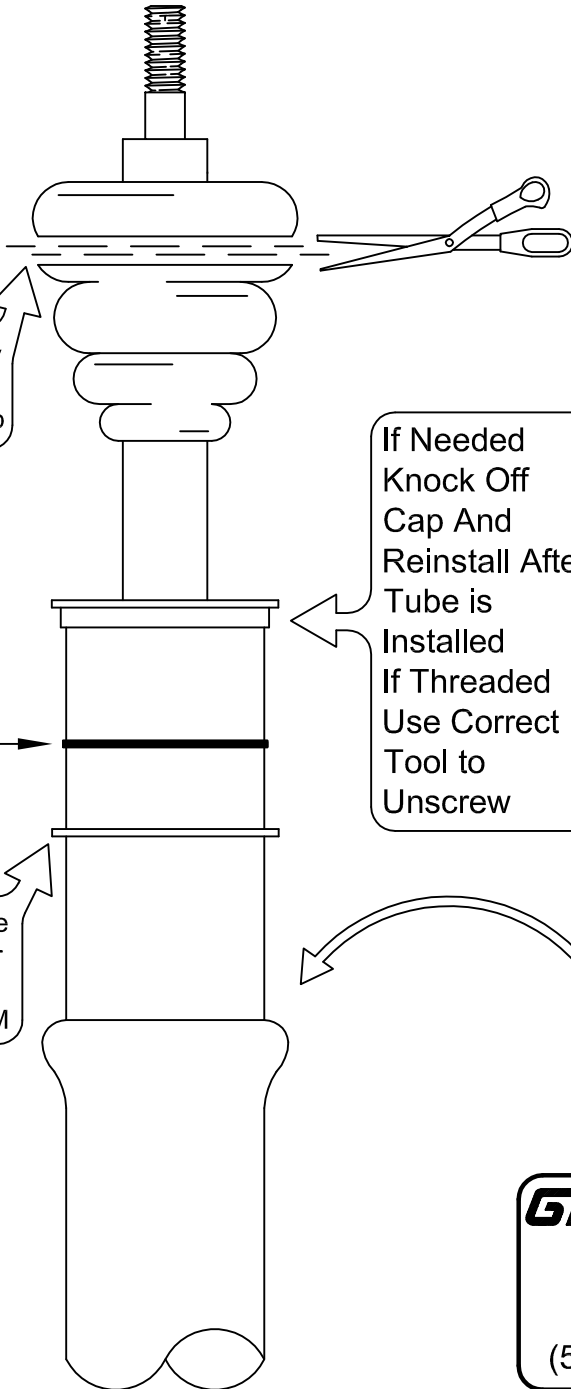
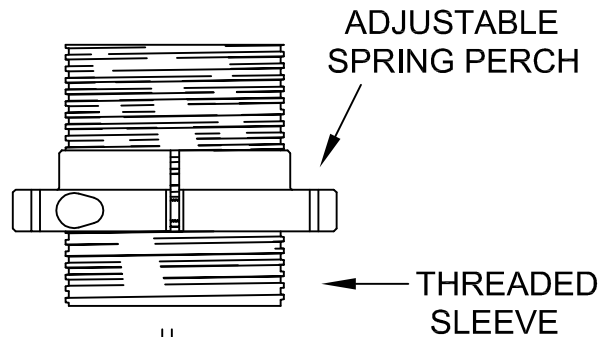
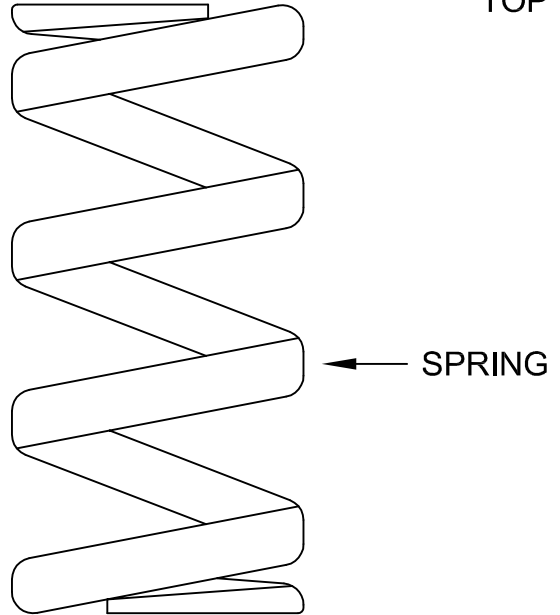
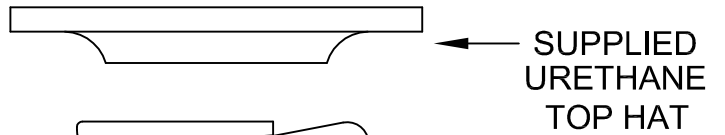
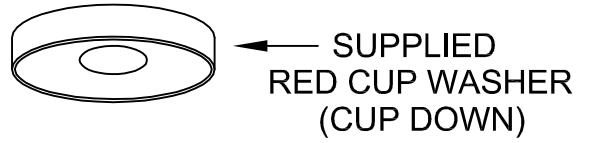
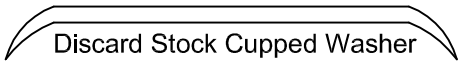
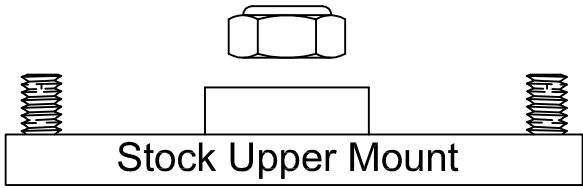

Cut Approximately 1/4" Off The Top Of The Bump Stop

If Needed Knock Off Cap And Reinstall After Tube is Installed If Threaded Use Correct Tool to Unscrew

O-Ring

Dust Boot Flange Must Be Filed Or Ground Down Slightly To 56MM

**GROUND CONTROL**  
[www.groundcontrolstore.com](http://www.groundcontrolstore.com)  
 3885 Dividend Drive  
 Shingle Springs, CA 95682  
 (530)677-8600 fax (530)677-9090