



makerspace electronics invention guide

TABLE OF CONTENTS

CIRCUIT BASICS —————○ P. 3

COMPONENTS —————■ P. 7

E- TEXTILES —————○ P. 18

PAPER BASED PROJECTS —————■ P. 48

MIXED MEDIA PROJECTS —————○ P. 75

DIGITAL FABRICATION PROJECTS —————■ P. 85

TROUBLESHOOTING —————○ P. 101

CIRCUIT BASICS

THINGS TO REMEMBER:

- A CIRCUIT IS ALWAYS A LOOP.
- ELECTRICITY FLOWS FROM POSITIVE TO NEGATIVE AROUND THE LOOP.
- EVERYTHING IN THE CIRCUIT MUST BE ORIENTED IN THE SAME DIRECTION FOR THE CIRCUIT TO WORK.
- ANYTIME A COMPONENT IS PUT INTO THE CIRCUIT BACKWARDS, IT CAUSES A BREAK IN THE CIRCUIT, MEANING IT BREAKS THE LOOP.

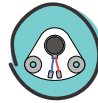

OUTPUT

This is the part that is powered in a circuit. The LEDs and buzzer are outputs in your kit.

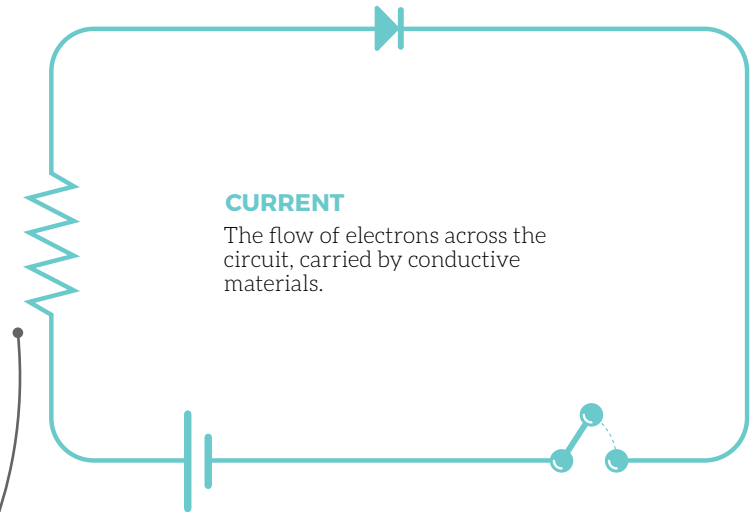

CURRENT

The flow of electrons across the circuit, carried by conductive materials.



RESISTANCE

Restricts the rate at which electrons flow through circuits. Conductive materials have different resistances.

POWER SOURCE

Provides power to the circuit. Yours is the coin cell battery.

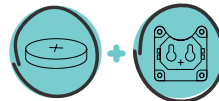

SWITCH

Closes and opens a break in the circuit.

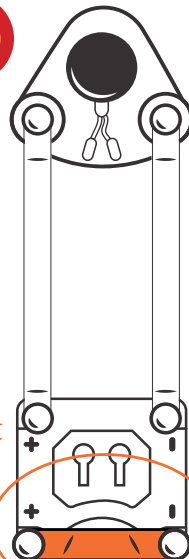
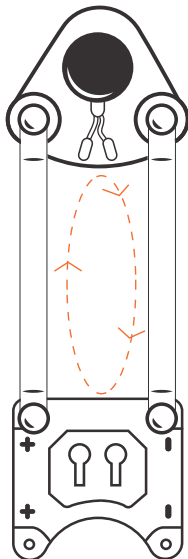
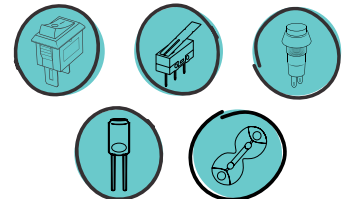

electricity

Short circuit

If you were to connect the circuit line in the diagram to the right, the current will flow through the shorter (orange) path and skip the path that connects to the LED.

This will result in a short circuit – a short circuit is basically equivalent to connecting from the positive end of the power source to the negative, without putting anything in between.

This will drain or “burn out” your battery very quickly. You should always make sure there are no short circuits in your design.

SERIES VS. PARALLEL

When you are connecting multiple outputs (in our case LEDs) in a circuit you can connect them in series or in parallel.

If two lights are connected in series, the circuit only has one loop and the same current flows through the lights. Here's an

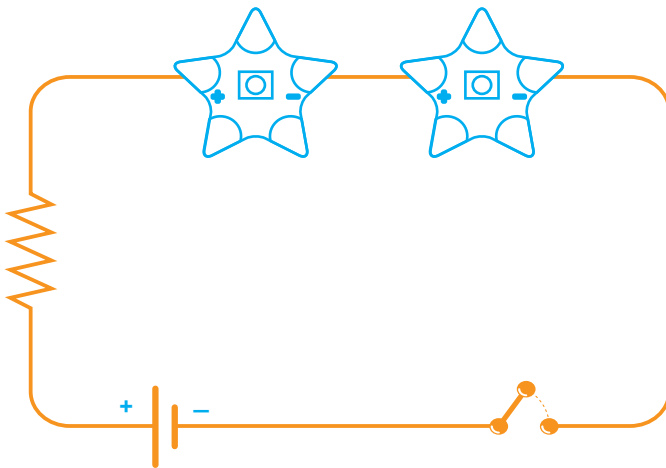

The current starts from the positive side of the battery, flows through both lights and then connects to the negative side of the battery. This also means that the same voltage is flowing through the circuit. This is where we encounter problems with our circuit. Each LED has a forward voltage of about 2.4 volts. This means that it needs 2.4 volts to turn on. The coin cell battery only supplies about 3 volts, so after the first LED there is only .6 volts left for the second LED. This is significantly less than the forward voltage on the LED, so the 2nd LED won't even turn on!

If we had a higher voltage battery, you could power more LEDs with a series circuit.

The alternative is to connect the components in parallel. This means that each LED has its own loop with the battery, as can be seen in the diagram below. In this case the current is split between the two (or more) loops.

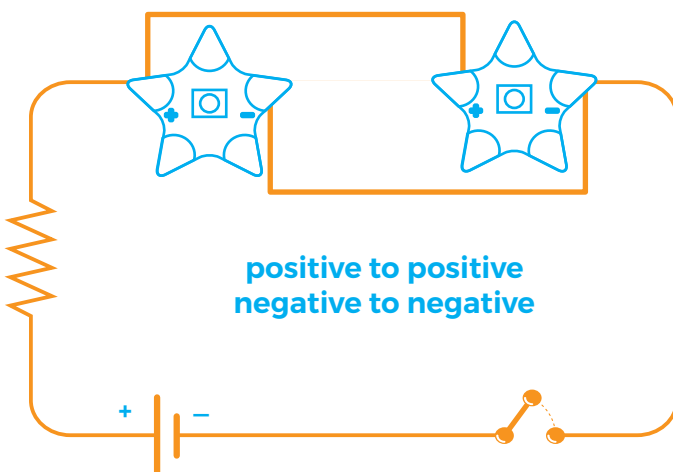

Though the LEDs are sharing the current, they are connected directly to the battery so they are not sharing the voltage. Your battery supplies about 60 mA of current, and each LED needs about 20 mA to turn on. This means that 3 volts is going to each LED and both LEDs will be able to turn on. You'll notice that some colors might be brighter than others. This is because different color LEDs have different forward voltages.

SEWING BASICS

HOW TO THREAD A NEEDLE

A. Cut about an arm's length of thread. Stick one end of your thread through the eye of the needle

B. Pull your thread until it is folded in half on the needle

C. Take the two ends of the thread and tie a knot

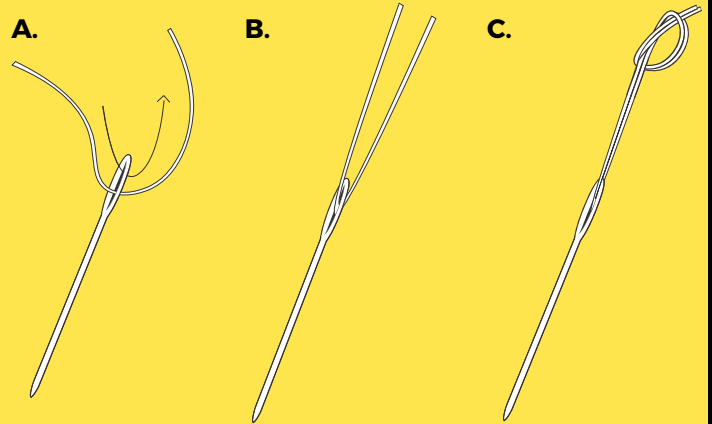

HOW TO SEW A CIRCUITBOARD

Take your **felt**, your **threaded (conductive thread) needle**, and a **Sewable LEDboard**.

First, place the LEDboard where you want to attach it to the cloth.

Then, take your threaded needle and starting from the back, push your needle through the cloth and the positive or negative pad of the LED. Loop the thread through the hole and cloth multiple times so the LED is secured tightly.

After looping a few times, push the needle down through the fabric next to the LED. Push the needle up through the fabric about 1/4 inch away and repeat up and down.

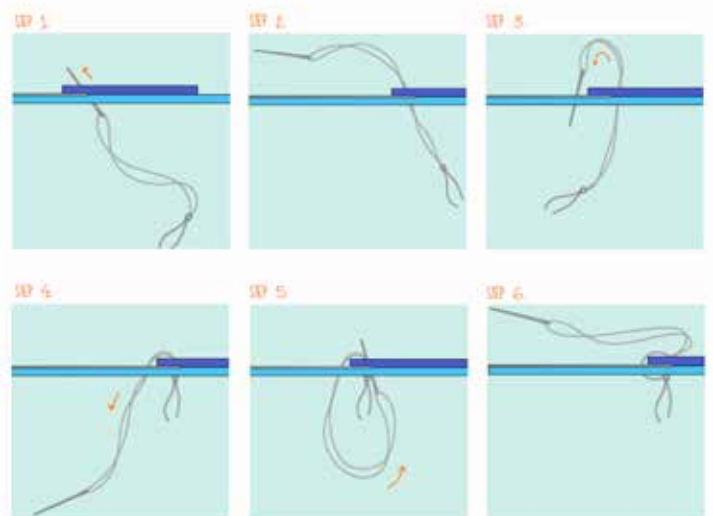

HOW TO SEW A CIRCUIT

Sew between the positive pad of the batteryboard and the positive pad of the .LED. It should light up

The red stitches indicate where the thread ends. Once you get to a red stitch or a hole on the board, tie a knot, cut the thread, and start with a new piece. When you are sewing around a conductive pad, make sure to loop around it a couple of times to make sure it is secure

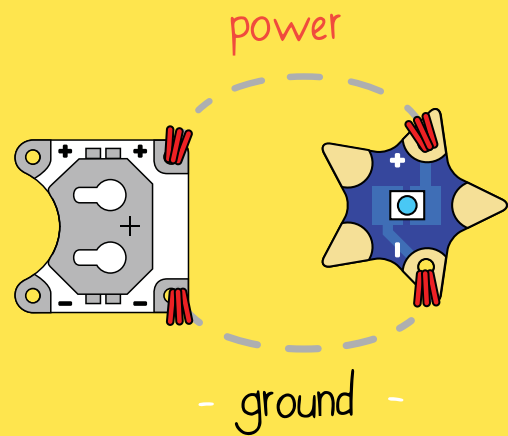

CONDUCTIVE PADS

Conductive pads are the silver or gold ends of the circuitboards that have holes in the middle. This is what you sew around when connecting a board to another part of the circuit or materials. You can also use alligator clips by clipping them to connect parts of a circuit together by clipping to the conductive pads

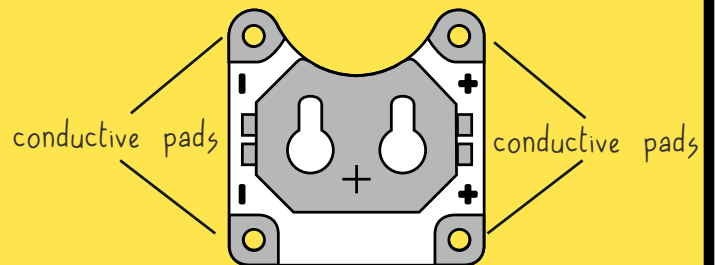

BEEPBOARD BUZZER

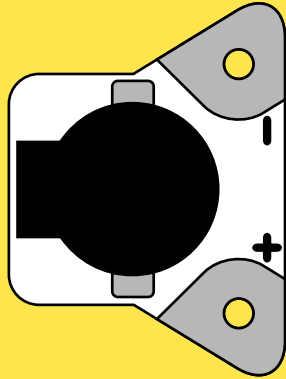

These mini buzzers create a beep noise, which is why we call them beepboards.

How they work

The buzzer in your kit contains a piezo element. When you put a voltage across a piezo, it vibrates and creates a tone. If you vary the power to your piezo you will hear this as a range of different tones.

How to connect

To connect the beepboards in a circuit it must connect to power. The gold pads are where you will connect the board to the circuit. Use the Teknikio Batteryboard and connect to “+” and “-” pads like in the diagram below using alligator clips or another connector.

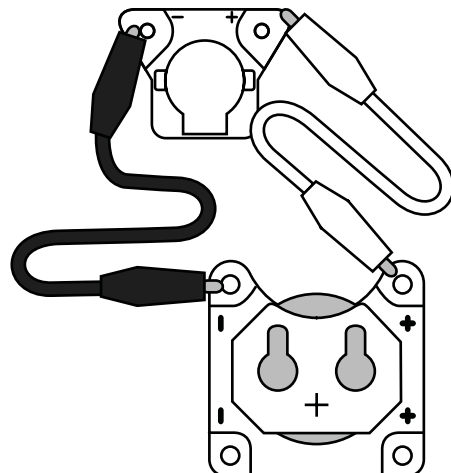

SEWABLE LEDBOARDS

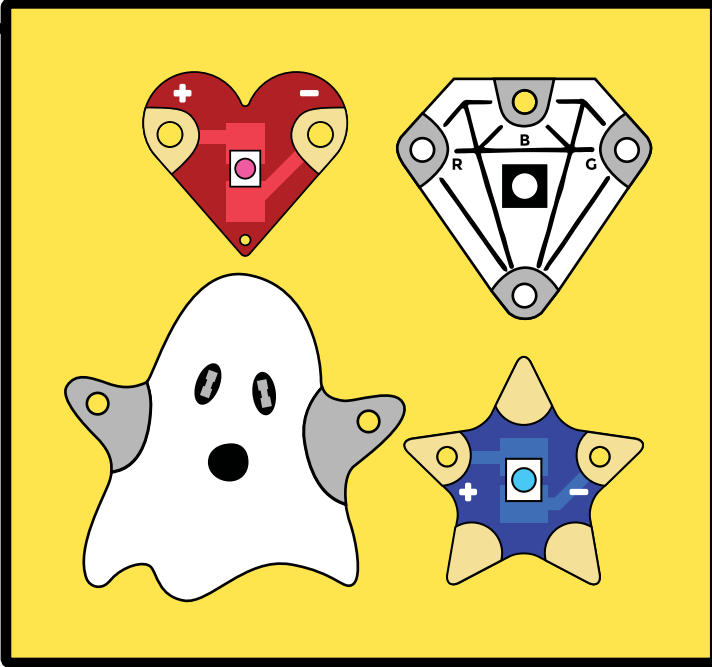

The LEDs in your kit are smaller surface mount LEDs.

You have 4 different LEDs in your kit:

The Star LED will emit blue light.
The Heart LED will emit pink light.
The Ghost LED will emit amber light.
The diamond RGB LEDs, the “+” pad is replaced by “R”, “G”, “B”. Each of these pads corresponds to a specific color: R for red, G for green and B for blue.

How they work

Each LED has a positive and negative pad. When electricity is flowing through them they turn “on” and produce light.

How to connect

To connect the LEDboards in a circuit connect them power. The positive and negative metal pads are where you will connect the board to the circuit.

Use the Teknikio Batteryboard and connect to “+” and “-” pads like in the diagram below using alligator clips or another conductor.

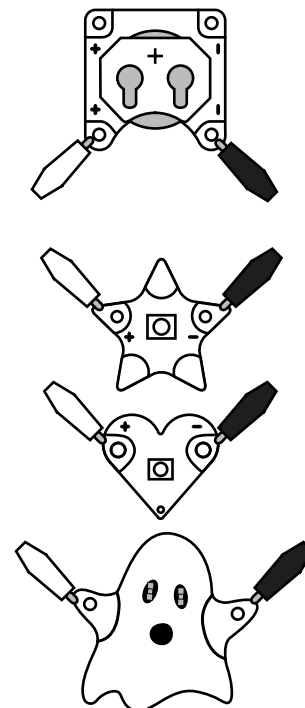

MOTIONBOARD

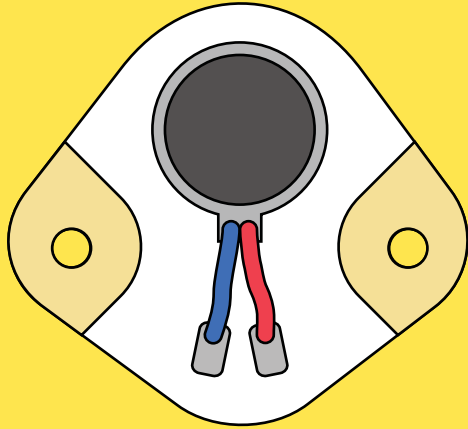

These mini motors are usually found in phones that have a “vibrate” feature.

How they work

The motors have an offset weight that makes them vibrate as the motor spins.

How to connect

To connect the motionboards in a circuit it must connect to power. The positive and negative metal pads are where you will connect the beepboard to the circuit.

Use the Teknikio Batteryboard and connect to “+” and “-” pads like in the diagram below using alligator clips or another conductor.

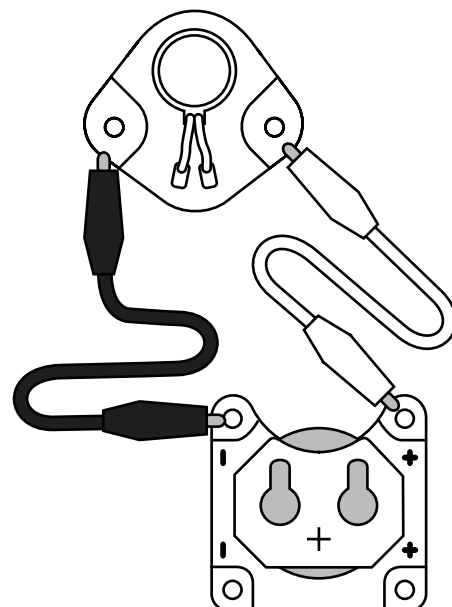

LIGHT SENSOR BOARD

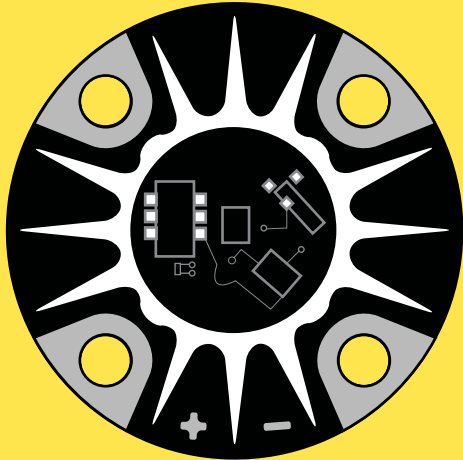

This sensor can measure light and trigger an output based on the lighting in the environment.

How they work

An ambient light sensor detects light, or brightness similar to the way a human eye perceives light levels. They are integrated into many different technologies such as TVs and phone screens to help save battery by adjusting the brightness of the screen based on ambient light.

How to connect

First the sensor needs power: connect “+” and “-” pads on the sensor to “+” and “-” pads on the batteryboard.

Let’s start with “Sense Light”. Connect the “Sense Light” pad to the “+” pad on the LEDboard. Then connect the “-” pad on the LEDboard to the “-” pad on the Batteryboard. Your LED should turn on! Now cover the middle of the sensor board with your finger, thus blocking light from the sensor, the LED should turn off!

Now connect the “Sense Dark” pad to the “+” pad on the LEDboard. Your LED should turn off! Now cover the middle of the sensor board with your finger, thus blocking light from the sensor, the LED should turn on!

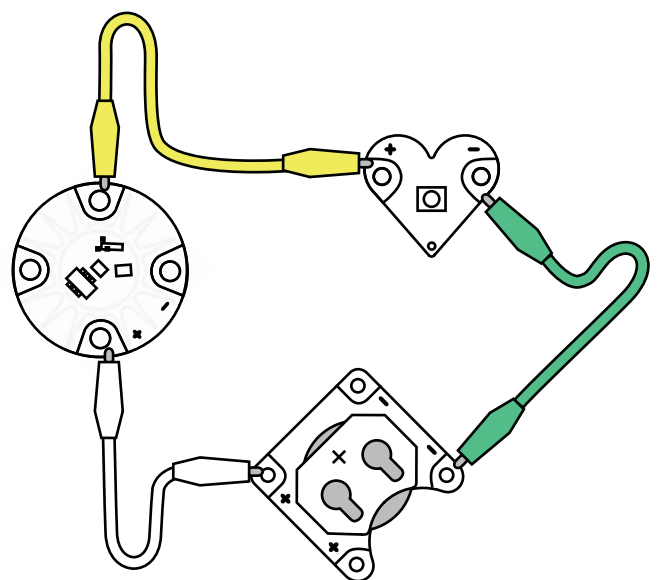

MAGNETIC REED SWITCH

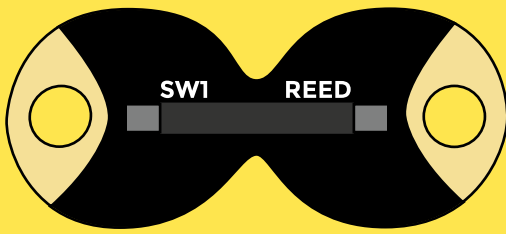

The reed switch is triggered by magnets. It can be used to measure distance.

How they work

From the outside the switch looks like a plastic box, but inside there are two pieces of metal sitting slightly apart.

When a magnet is near, the metal pieces make contact, closing the circuit. When the magnetic field is removed, the reeds separate and the switch opens.

How to connect

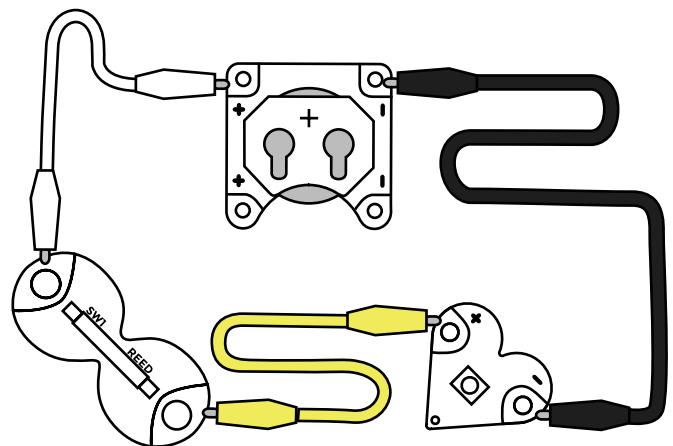

TEMPERATURE SENSOR

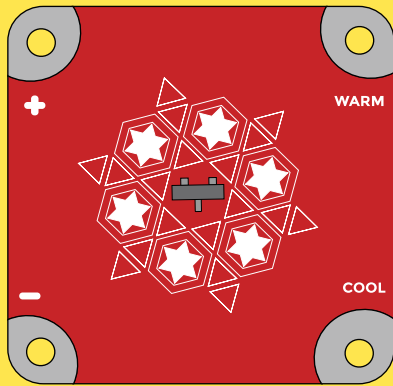

This switch has two modes: you can connect to turn something on with “sense cold” (below 70 °F) or “sense hot” (above 80 °F).

How they work

The temperature is built around a thermistor, which changes its resistance with temperature. On this board we are measuring the resistance when hot and cold and sending a signal when those points are reached.

How to connect

First the sensor needs power: connect “+” and “-” pads on the sensor to “+” and “-” pads on the batteryboard.

Let’s start with “Warm”. Connect the “Warm” pad to the “+” pad on the LEDboard. Then connect the “-” pad on the LEDboard to the “-” pad on the Batteryboard. Place the sensor in a hot place. Your LED should turn on! Now place the sensor in a cooler place and the LED should turn off!

Now connect the “Cool” pad to the “+” pad on the LEDboard. Place the sensor in a cold place- your LED should turn on! Now place the sensor in a warmer place and the LED should turn off!

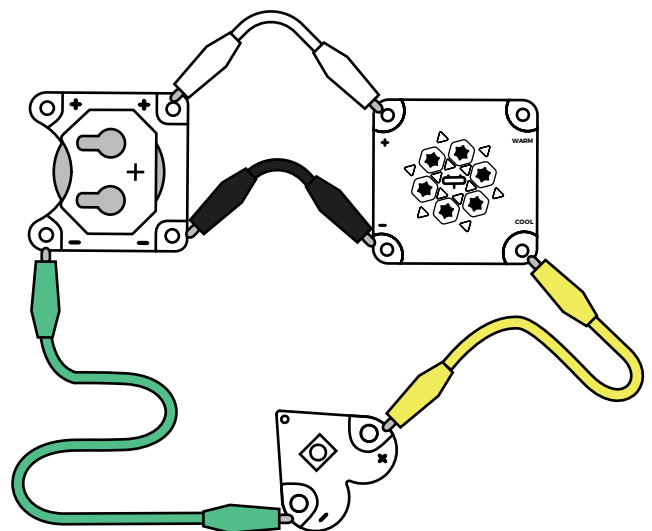

BATTERYBOARD

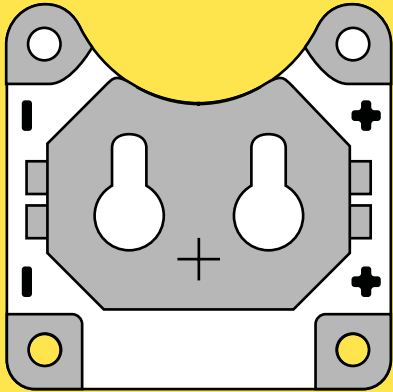

When inserting your battery in the board make sure the smooth side with the “+” is facing up.

How they work

The batteryboard has a metal clip that secures a coin cell battery in place.

How to connect

The Batteryboard has 4 metal pads, two negative pads and two positive pads. Connect these pads to other elements of a circuit to provide power to the circuit!

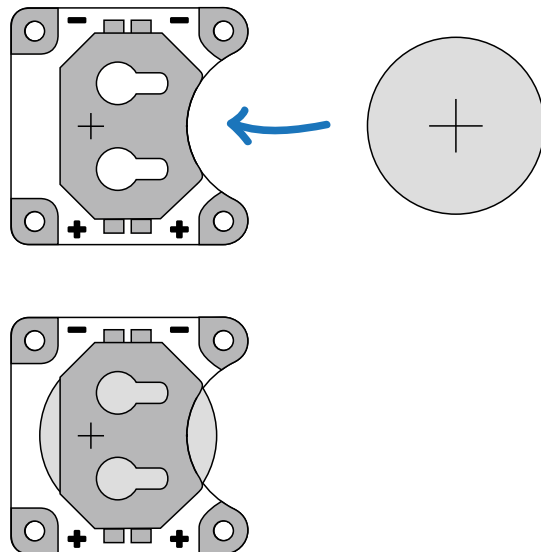

ALLIGATOR CLIPS

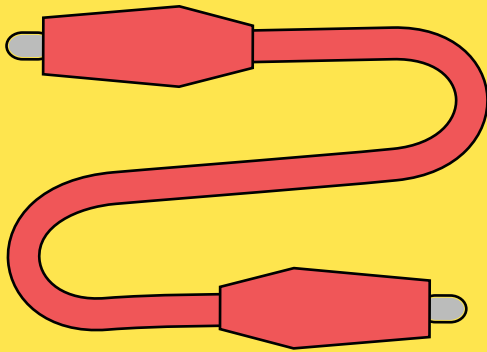

Use the alligator clips to attach parts without making a permanent connection.

How they work

The alligator clips have wire running between the metal clips. The wire is insulated by a coat of plastic, protecting the wire from crossing or shorting with other signals..

How to connect

Pinch the ends to open the claws and clip them on.

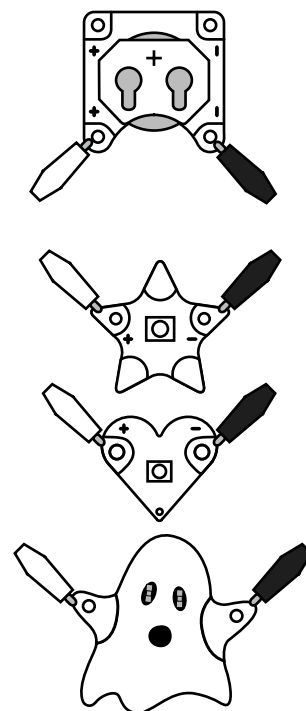

SPOOL OF CONDUCTIVE

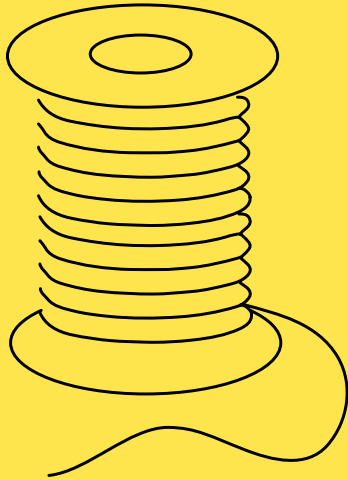

This thread has silver strands which are conductive.

How they work

The silver in the thread lets electrons pass through the thread and allows it to carry or transmit power and signals through a circuit. Steel is another metal commonly used to make conductive thread.

How to connect

Conductive thread can be sewn just like regular sewing thread. We recommend doubling the thread around your needle so that there is more surface area with each stitch.

CONDUCTIVE TAPE

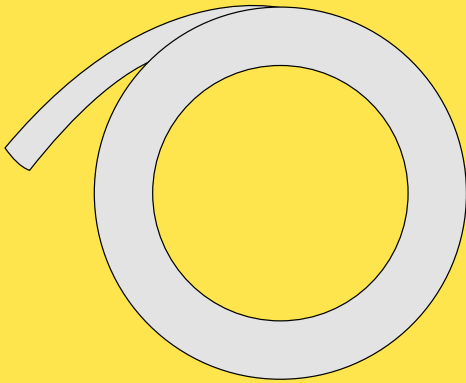

This tape is made woven silver strands, making it conductive.

How they work

The silver in the tape lets electrons pass through the thread and allows it to carry or transmit power and signals through a circuit. Copper is another metal commonly used to make conductive tape.

How to connect

To use the tape, peel off the paper back and place it between two components. The adhesive side of the tape is also conductive, so you can place the tape under or over components.

RECOMMENDED TOOLS AND MATERIALS

Your kit comes with an array of electronic parts and conductive materials needed to build the projects in this guide. However, there are no raw materials for crafting and no batteries included in your kit.

We have made a list of recommended supplies below, many of which you may be able to find at local reuse/recycle center.

We also have a list of tools that will help you build each project. Not every tool is necessary for every project.



Coin Cell
Batteries
CR2032



Felt
Pieces



Sewable
Metal Snaps



Cardboard



Glass Jar



Elastic
Band



Magnet



Paper



Paper
Fasteners



Electrical or
scotch Tape



Totebag



Dowel



Model
Magic



Beads



Sewing
needle +
regular thread

Scissors

Gluegun

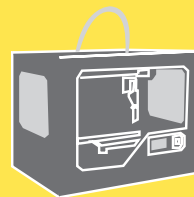

3D Printer



Lasercutter

Multimeter



Sewing



Superhero Facemask

Make your inner superhero come to life by making a mask that will teach you the skills of building how to sew a parallel circuit that will make LEDs turn on.



Duration
25 mins

Difficulty Level



Parts and Materials

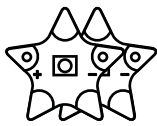

Star
LEDboard
x2

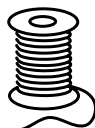

Conductive
Thread

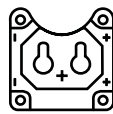

Battery
Board
x1



Coin Cell
Battery
x1

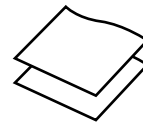

Felt
Pieces



Elastic
Band

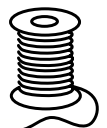

Sewing
Thread

From the kit

Additional

1 PREP

Trace and cut two face maske shapes out of felt or the fabric of your choice. The templates are in the templates folder of this guide.

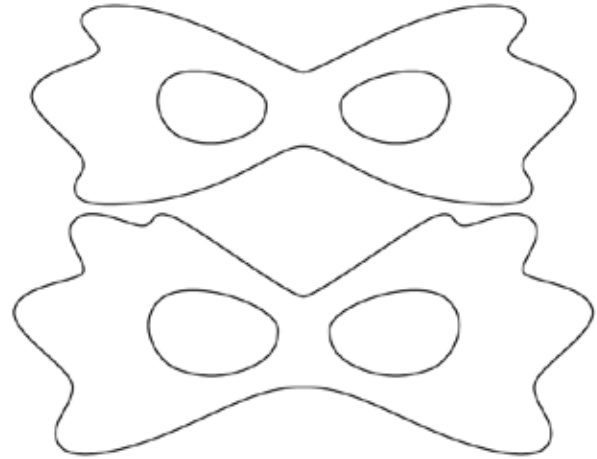

2 PLAN YOUR CIRCUIT

This circuit contains two LEDs, a battery, and a batteryboard. The snaps are made of conductive metal, meaning electricity can flow through them when they touch. In the circuit, the snaps act as a switch to turn the light off and on.

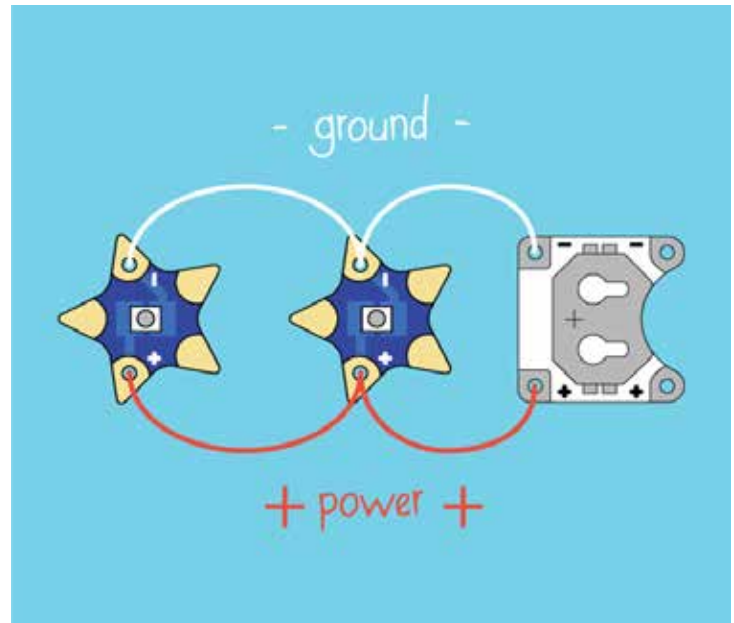

3 ATTACH THE LEDBOARD

Thread your needle with conductive thread. We recommend doubling the thread for a stronger electric connection.

Attach the LEDboard to the felt by holding it in place on the fabric and looping around the positive pad 3 - 5 times.

Use a running stitch to connect the positive pad on the second LEDboard. Sew around the second pad, secure with a knot, and trim the extra thread.

Repeat this process to connect the positive holes.



4

ATTACH THE BATTERYBOARD

Using conductive thread again, attach the batteryboard (without a battery) to the back of the mask. Make sure the “+” and “-” pads on the batteryboard are aligned with the LEDboards.

To make the components extra secure, you can sew the extra sew-holes to the felt with non-conductive thread.

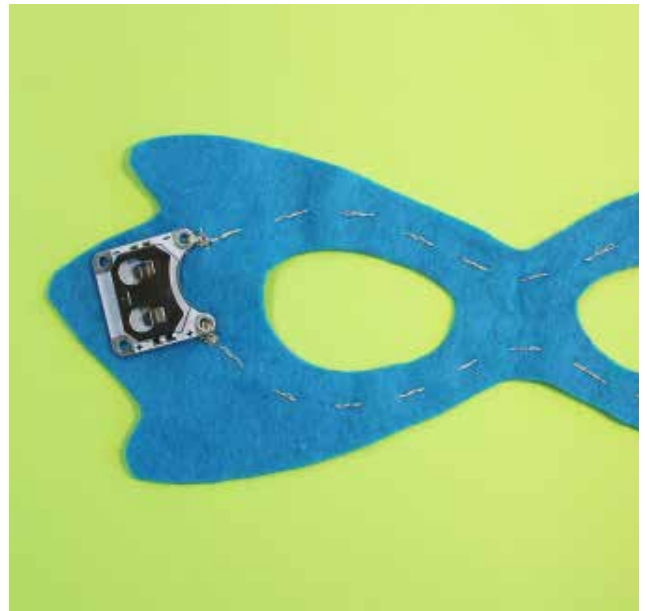

5

MAKE IT WEARABLE

Using glue, attach the second piece of felt to the back of the mask. Make sure you can still access the batteryboard to eventually remove or change out the battery.

Cut a small hole on each side of the facemask and tie the elastic in one end. Hold the mask to your face, bring the elastic around the back of your head, and mark the elastic where it meets the other hole. Loop the elastic through the second hole and tie a knot to secure it.



6

WEAR AND TEST

Insert the battery- the LEDs should light up!

Now try it on!



Sewing

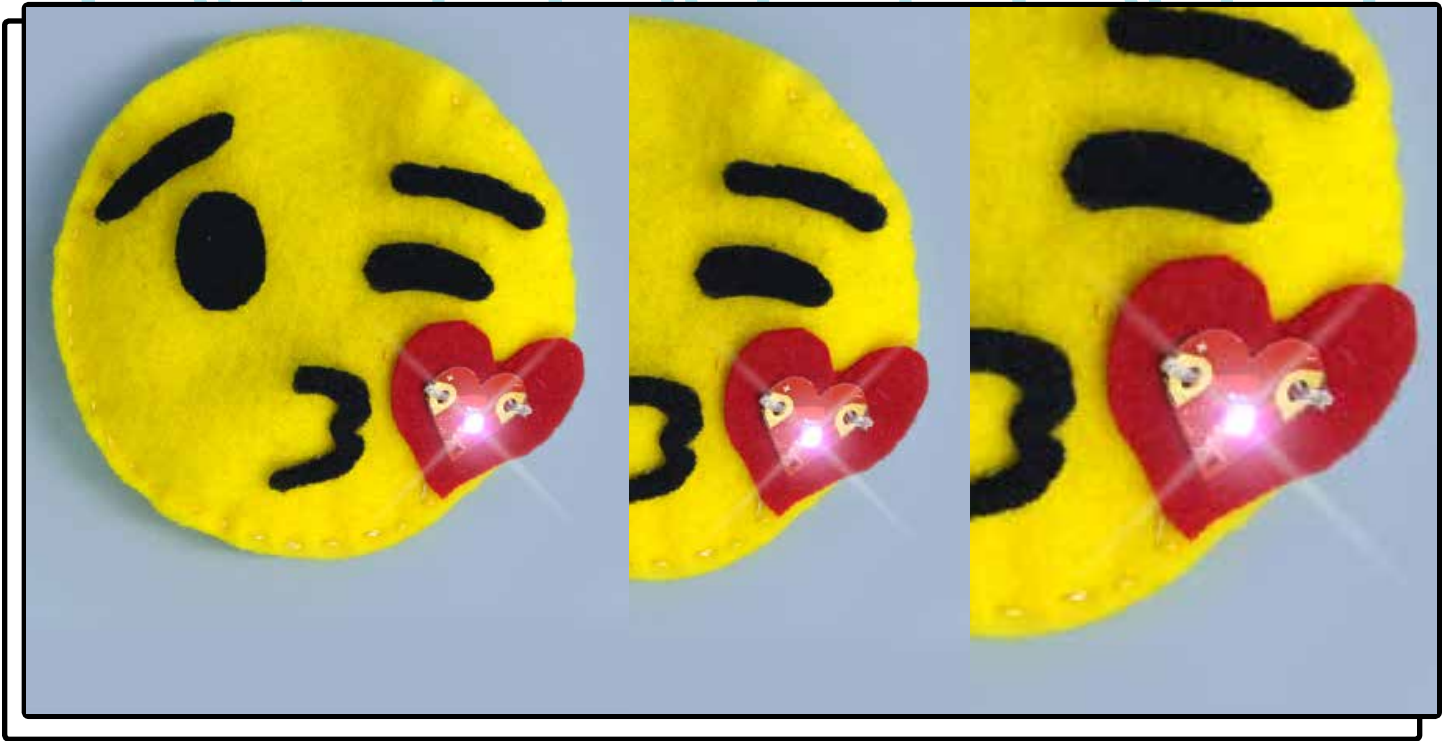

Secret Message Emoji

Make a dynamic Secret Message Emoji that will expand your knowledge on how build circuits with textile designs.



Duration
25 mins

Difficulty Level



Parts and Materials



Heart
LEDboard
x1

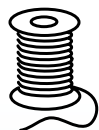

Conductive
Thread

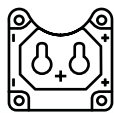

Battery
Board
x1



Coin Cell
Battery
x1

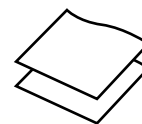

Felt
Pieces



Elastic
Band

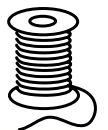

Sewing
Thread

From the kit

Additional

1 PREP

Using the template provided, pick which emoji you'd like to make. For this tutorial, you'll be making the Blowing Kiss emoji.

Cut out the shapes using the template. The heart for the Blowing Kiss emoji is optional. Using a running stitch, sew the two big circles along the edge. Don't sew all the way around. Leave a gap at the top so that it is big enough for you to put a secret message or gifts! Glue on the features of the emoji's face on.

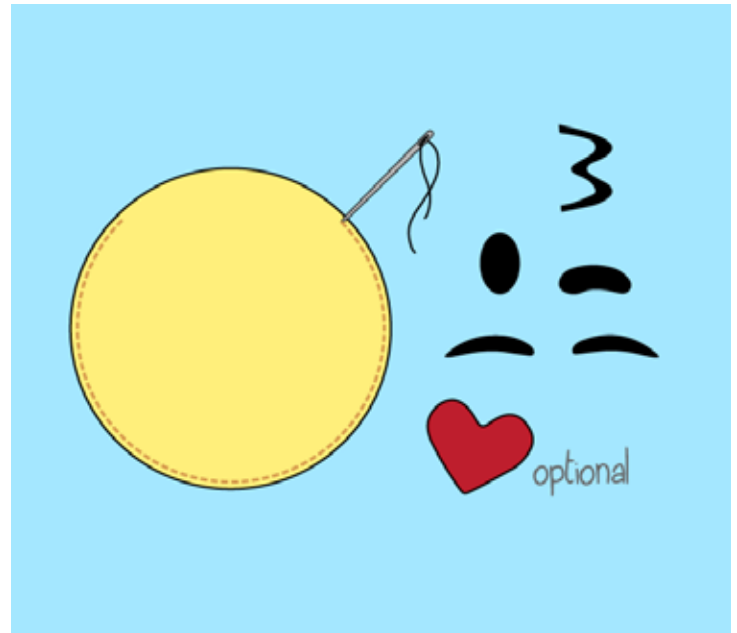

2 PLAN YOUR CIRCUIT

This circuit contains a LED, and a battery.

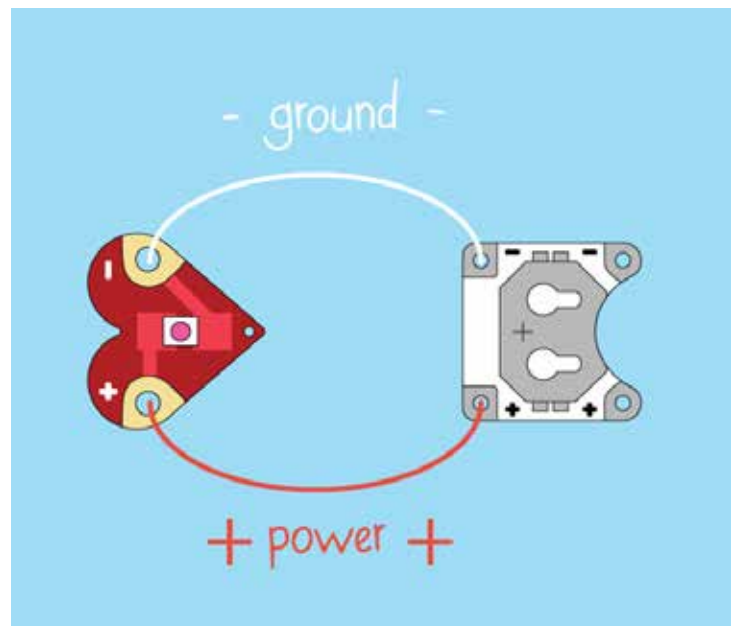

3 PLACE YOUR COMPONENT

Place your components on the emoji to see how to plan your circuit. The batteryboard should be placed on the back of the emoji. Place the Heart LED on the heart shaped felt on the front.

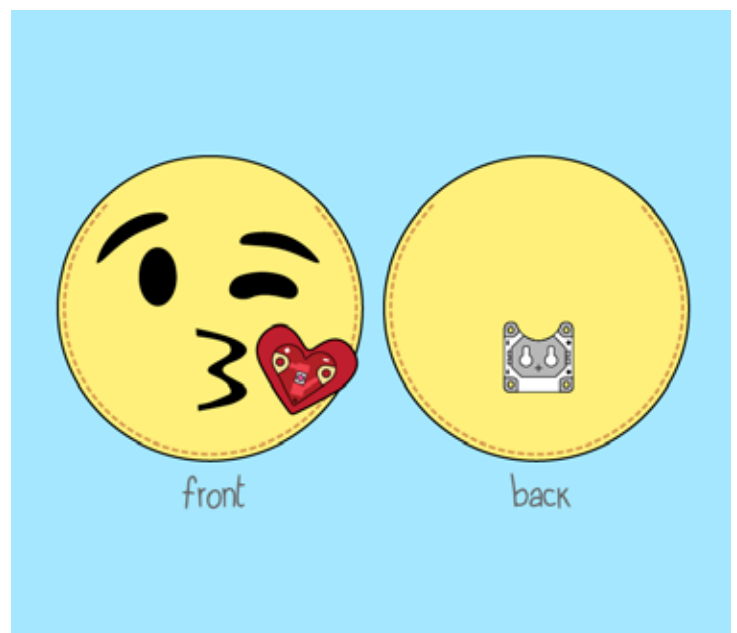

4 CONNECTING THE POSITIVES (+)

Start by attaching the positive pad on the batteryboard and make sure to loop around the pad 3 - 5 times.

Use a running stitch to sew around the emoji to the front and connect to the positive (+) pad of the heart LED. Loop around the positive (+) pad 3 - 5 times.

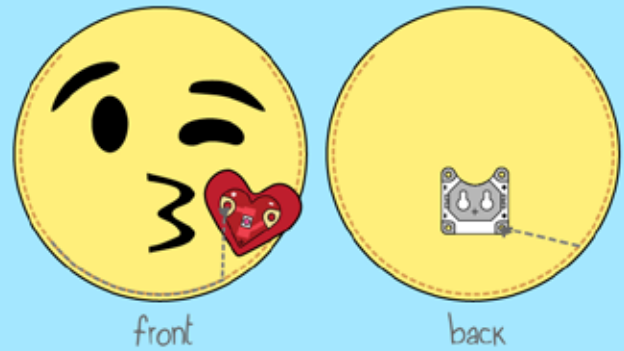

5 CONNECTING THE NEGATIVES (-)

Attach the negative pad on the batteryboard and make sure to loop around the pad 3 - 5 times.

Use a running stitch to sew around the emoji to the front and connect to the negative (-) hole of the heart LED. Loop around the negative (-) hole 3 - 5 times. At this point, your circuit should be complete.

To secure your batteryboard, you can use regular thread to sew the unused holes.

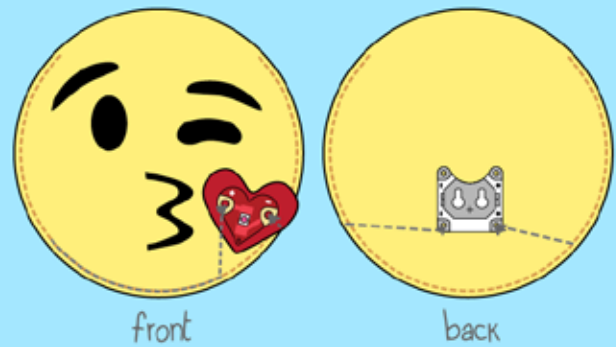

6 TEST YOUR CIRCUIT

At this point you can insert your battery into the batteryboard. Make sure the "+" faces up to match the "+" on the batteryboard. Your LED should light up!





Robot

Do we want a short description for this tutorial? Like oh this is perfect for people who are just starting to learn about STEM. Blah blah blah!

 Duration
25 mins

Difficulty Level

Parts and Materials

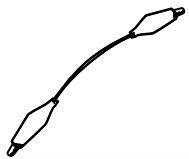

Alligator Clip
x3

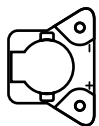

Beepboard
x1

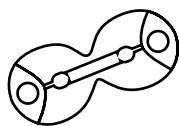

Magnetic
Reed Switch
x1

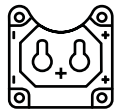

Battery
Board
x1



Coin Cell
Battery
x1



Magnet
x1



Cardboard

From the kit

Additional

1 PREP

Find a piece of cardboard around 8 inches long and 2-3 inches wide to make a two rectangular boxes.

Fold the cardboard into a cube shape and use glue or tape to hold the shape together.

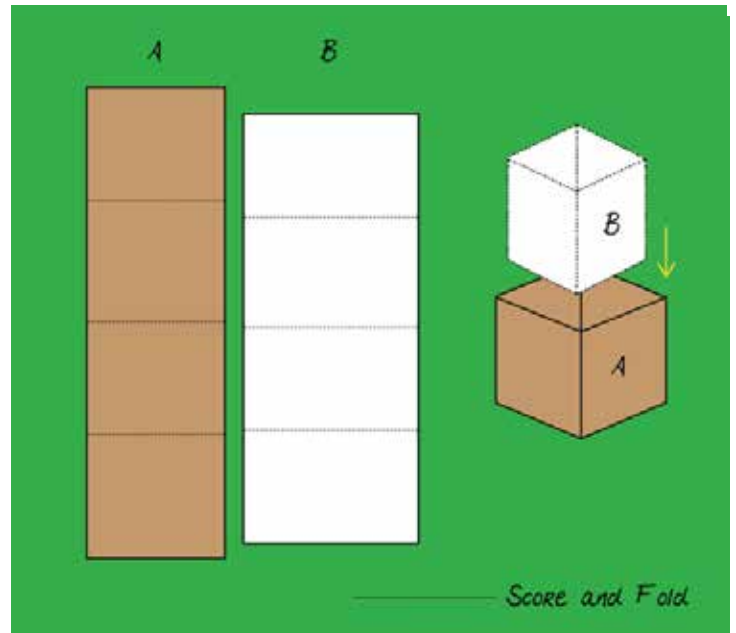

2 PLAN YOUR CIRCUIT

Place the coin cell battery into the battery holder.

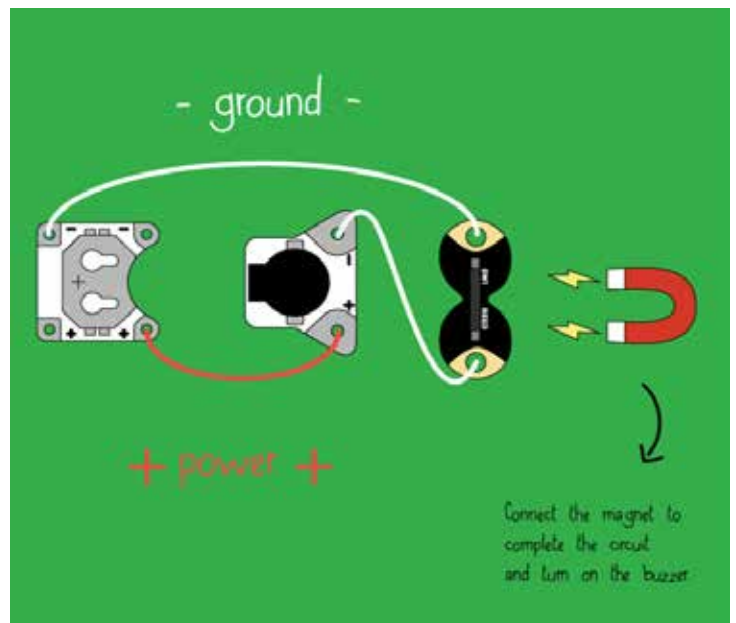

3 PLACE THE COMPONENTS

Tape the magnet reed switch and buzzer to the front of the robot box to hold them in place as you connect the components

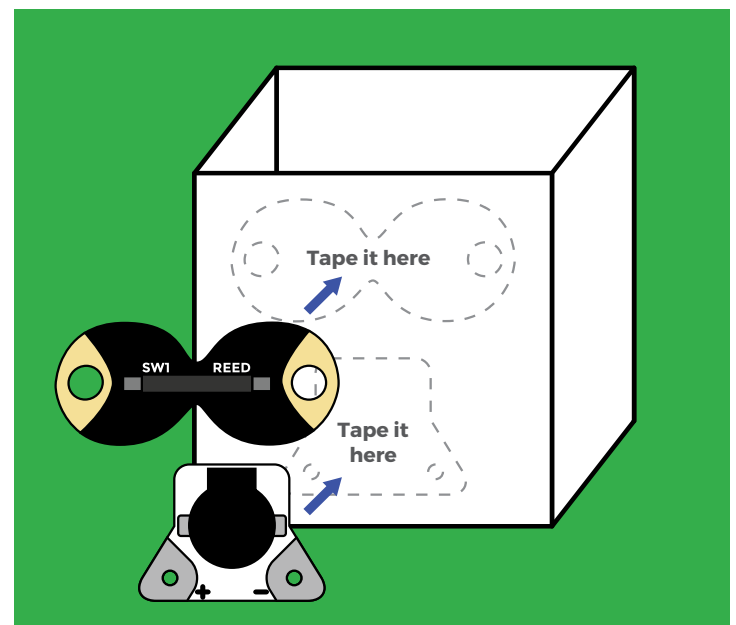

4 ADD THE BATTERYBOARD

Place the batteryboard with a battery inserted inside the cube. Connect one alligator clip connected to the negative (-) pad and another clip connected to the positive (+) pad.

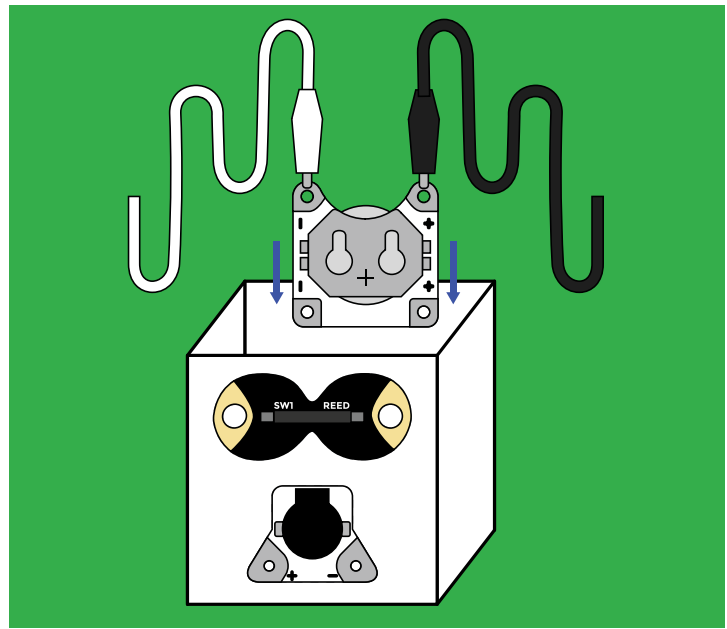

5 WRAP AND CONNECT

Connect another alligator clip to the positive (+) side of the coin cell battery and one side of the magnet sensor.

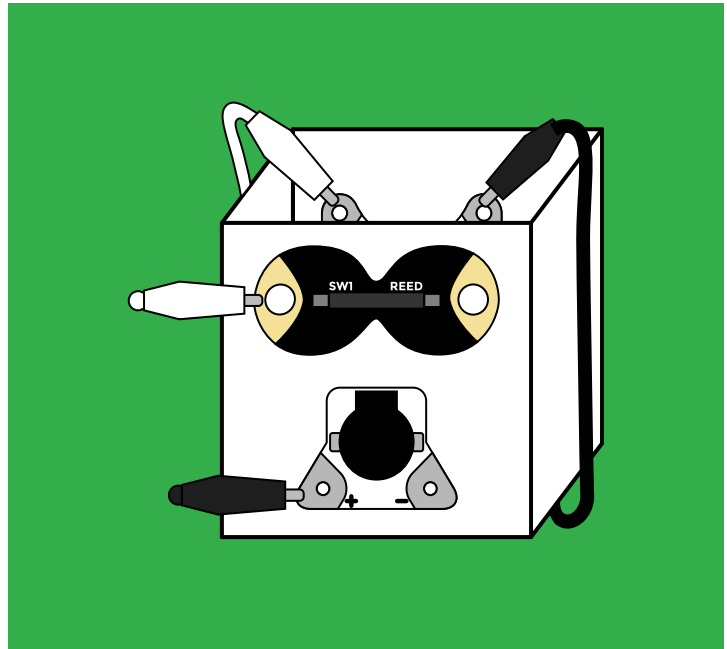

6 CLOSE THE CIRCUIT

Connect a third alligator clip to the negative (-) side of the buzzer and wrap it around the side of the cube. Attach the other side of the alligator to the other side of the magnet switch.

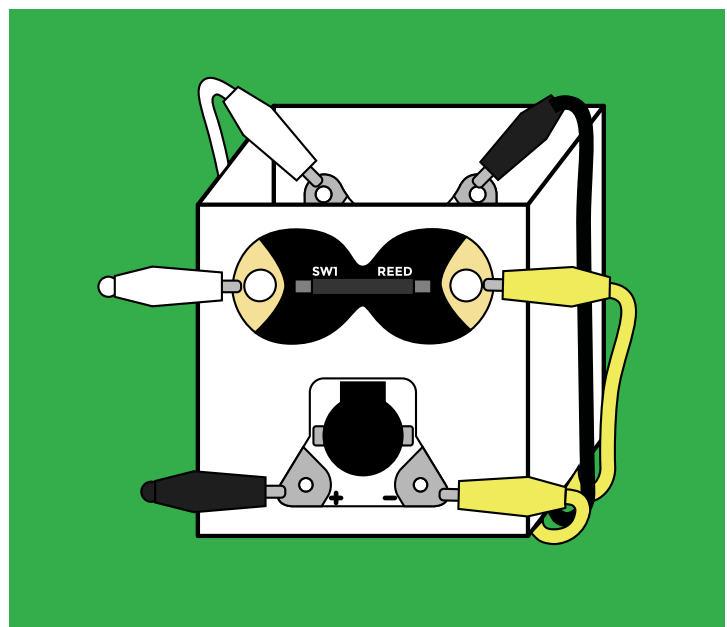

7 MAGNET EYES

Cut a small piece of cardboard that can fit over the reed magnet switch and draw or glue eyes onto the front.

Glue a magnet to the other side.

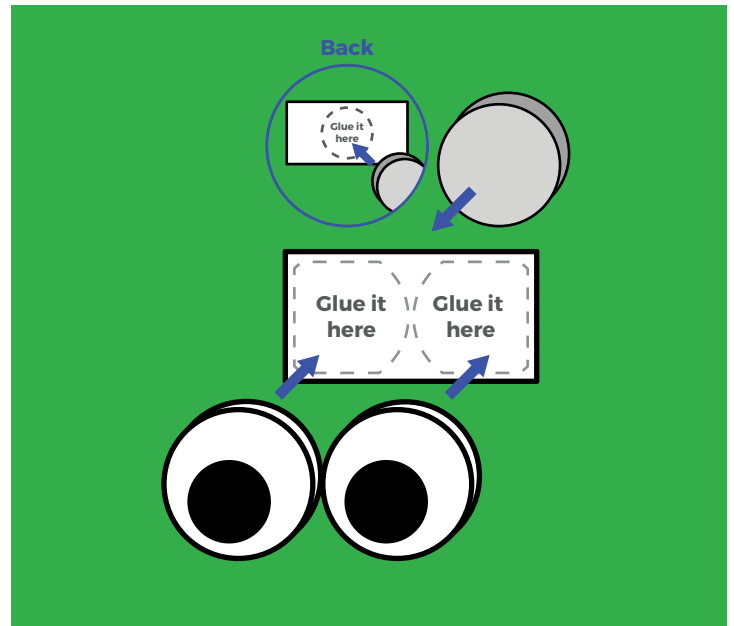

8 TEST

Place the eyes over the reed switch such that the magnet is over the switch. The buzzer should go off!

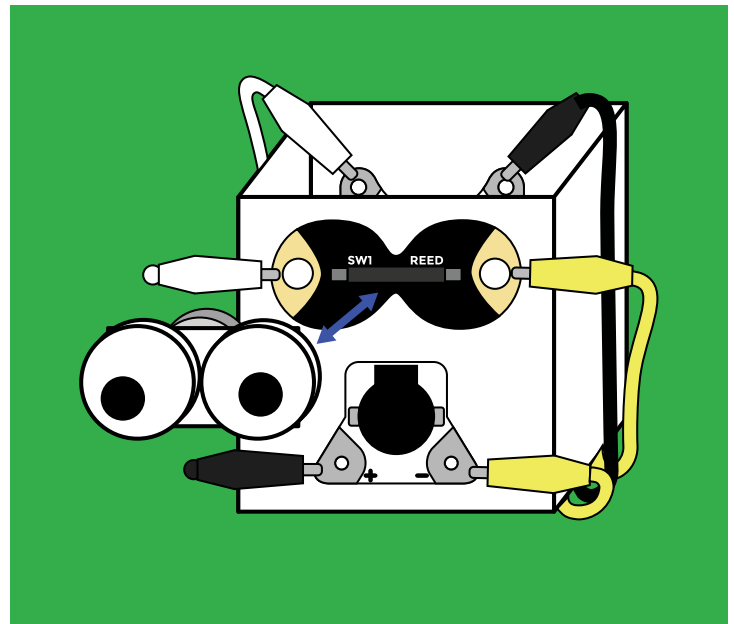



Paper



Spy Light

See what amazing messages you uncover using your light stick to light up your messages in the frame!



Duration
25 mins

Difficulty Level



Parts and Materials



Ghost
LEDboard

x1

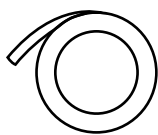

Conductive
Tape

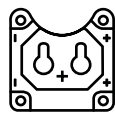

Battery
Board

x1



Coin Cell
Battery

x1

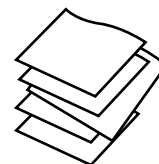

Paper

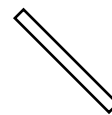

Popsicle
Stick

From the kit

Additional

1 CREATE THE FRAME

To make the frame, cut and score the cardboard according to the template in to your preferred size.

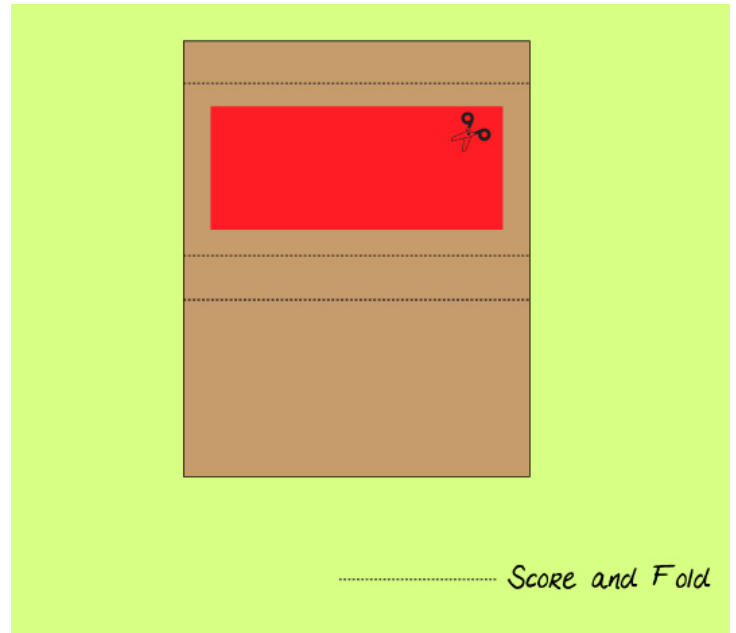

2 CREATE THE SCREEN

Cut a piece of copy paper just a little bit bigger than the opening on the frame, then fold in half and glue the long edge. Now you have a little envelope for your secret message.

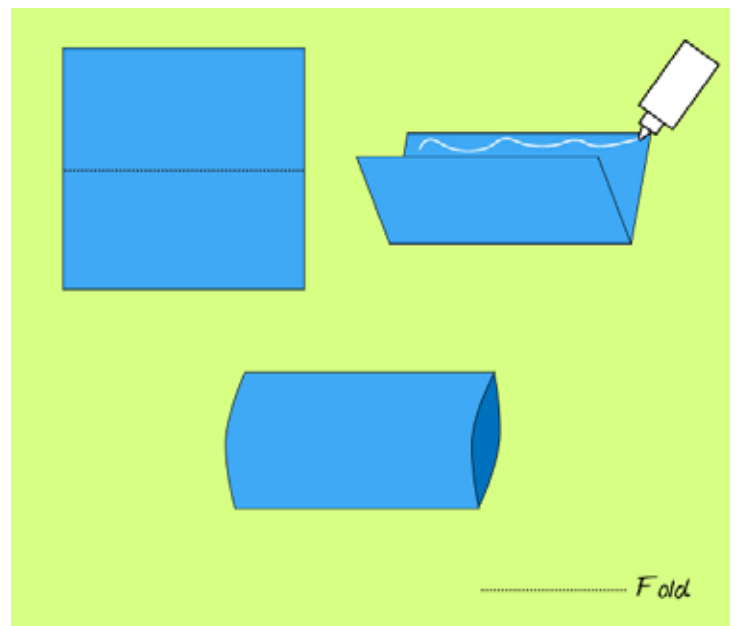

3 GLUE THE FRAME TOGETHER

Glue the envelope you just made onto the back of the frame, covering the opening you cut out off the cardboard frame at the beginning.

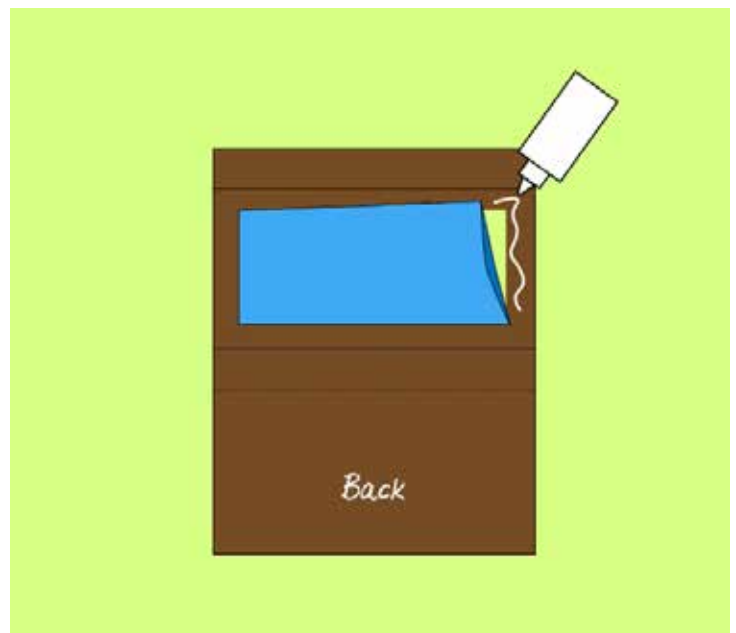

4 ASSEMBLE THE FRAME

Assemble the frame by folding and gluing the sides, creating a box.

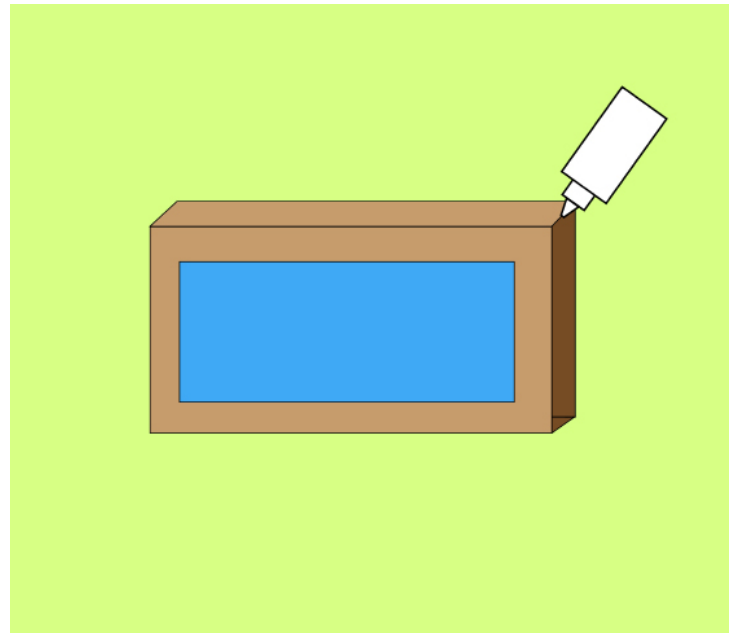

5 WRITE YOUR SECRET MESSAGE

Cut another piece of paper, such that it will fit inside the screen. Write your secret message, preferably with a bold pen/marker.

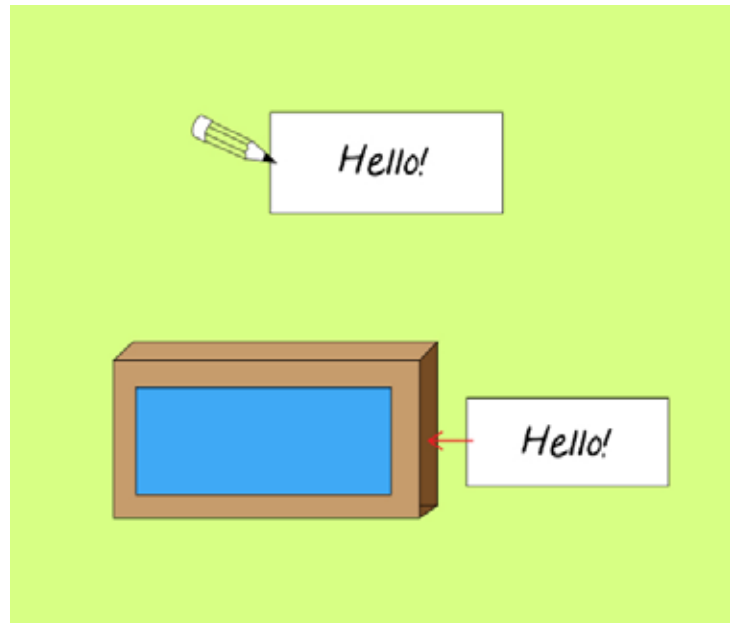

6 CREATE THE LIGHT STICK

Place the LED and battery on opposite sides of the popsicle stick.

Using conductive tape, connect the positive pad of the LED onto the positive side of the battery which is marked with a + and the negative pad to the negative side of the battery which is the embossed side.

Make sure that the 2 tape pieces don't touch each other. Now your light stick should light up!

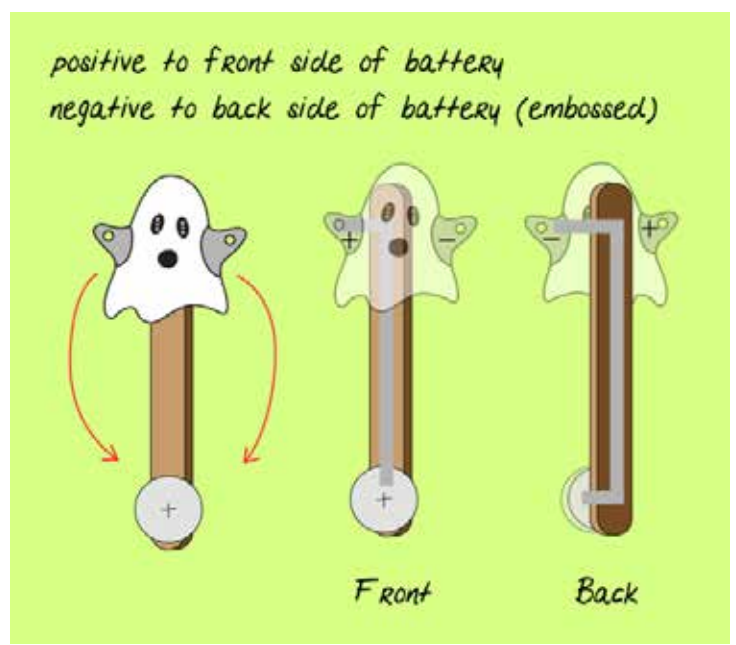

7 TEST IT OUT

Use the light stick you just created, you can now reveal the secret message you wrote earlier by guiding the light stick to light up certain area of the screen! Change the messages anytime you want.

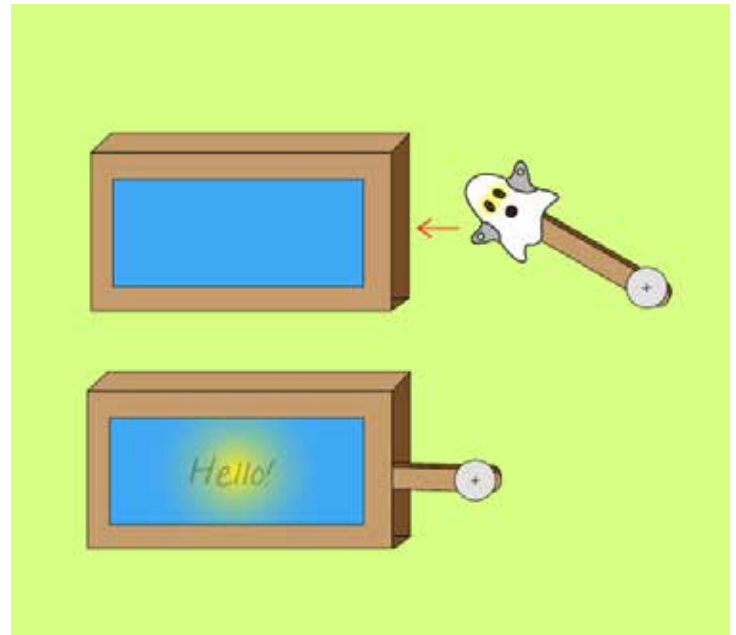



Paper



Electric Yurt

Learn how to build a circuit using conductive tape, cardboard, a batteryboard, LED, and magnetic switch! Observe your LED light up when you open the yurt's door!



Duration
25 mins

Difficulty Level



Parts and Materials

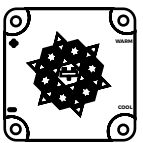

Temperature
Sensor
x1



Ghost
LEDboard
x1

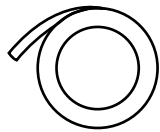

Conductive
Tape

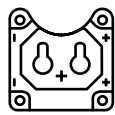

Battery
Board
x1



Coin Cell
Battery
x1



Cardboard



Paper
Fasteners

From the kit

Additional

4 PREP

Cut out the cardboard pieces for your yurt house based on the diagram. The scale is in inches.

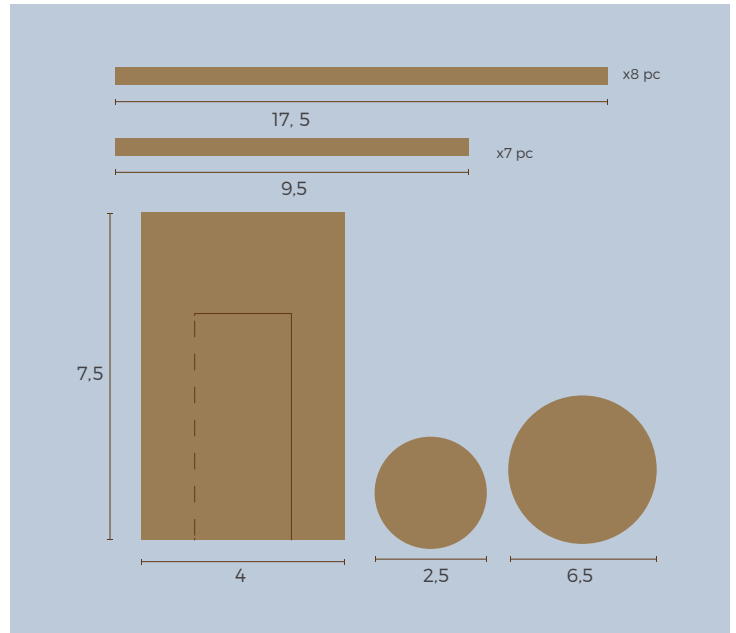

5 MARK THE HOLES

Measure and mark out the distances on the wall pieces of the yurt. These points mark the connections of the wall structure.

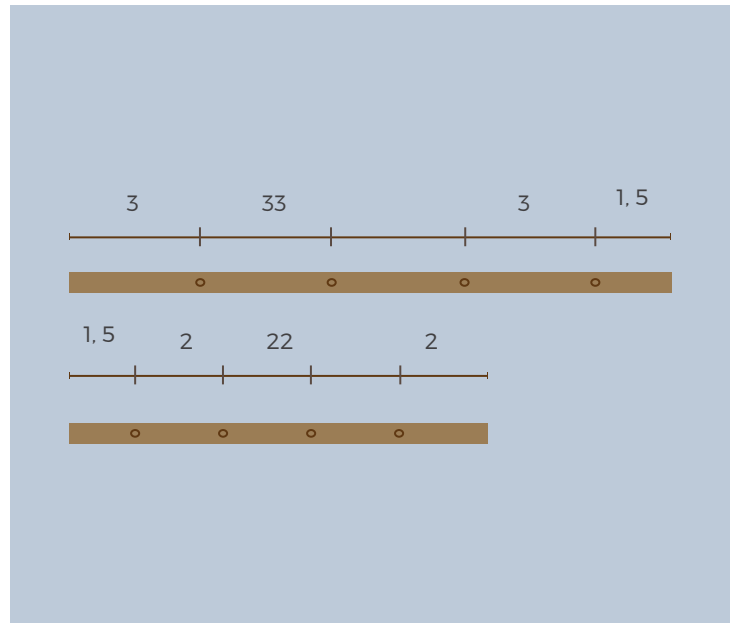

6 PLAN YOUR CIRCUIT

Connect the magnetic switch to the negative side of the batteryboard. Then connect the positive batteryboard to the heart LEDboard. Complete the circuit by connecting the negative side of the LEDboard to the magnetic switch.

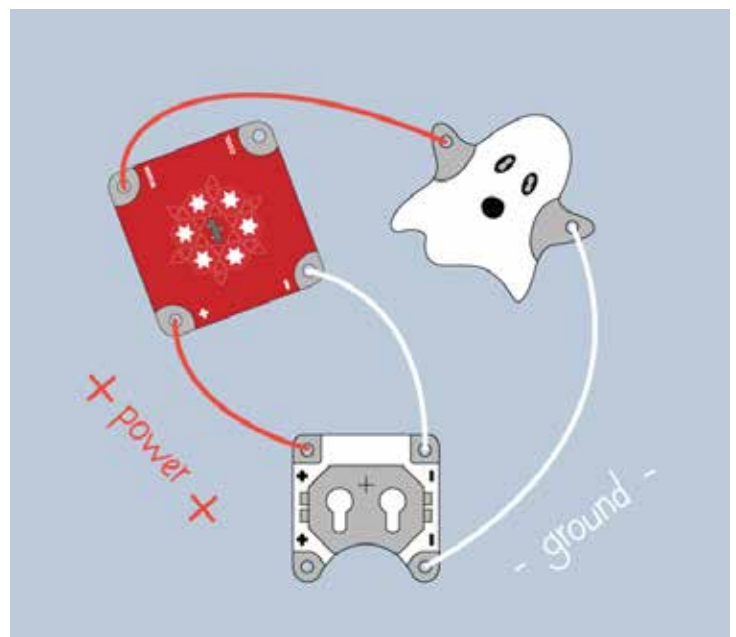

7 BUILD YOUR WALL

Use paper fasteners to pin together your wall pieces into a grid pattern. Adding connections will make your wall structure expandable.

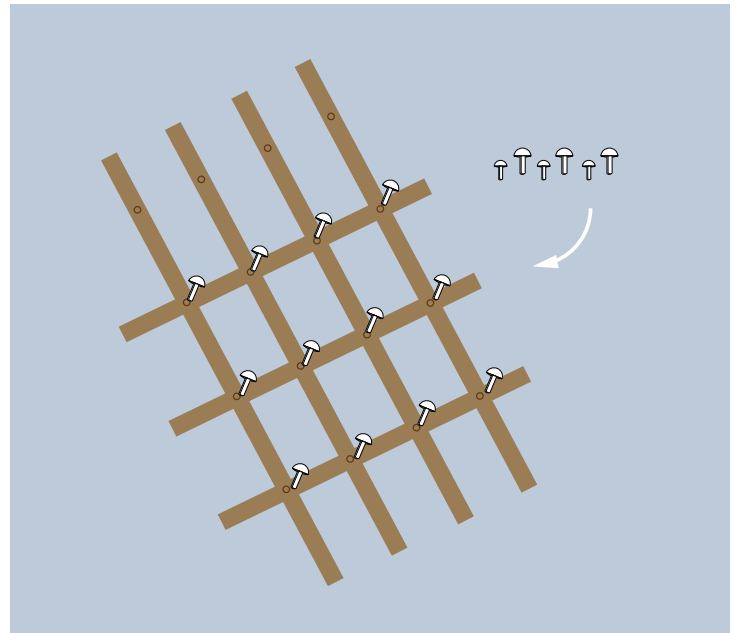

8 ASSEMBLE PIECES

Connect your door piece to the base and add the wall structure. You can use tape, pins or paper fasteners secure everything.

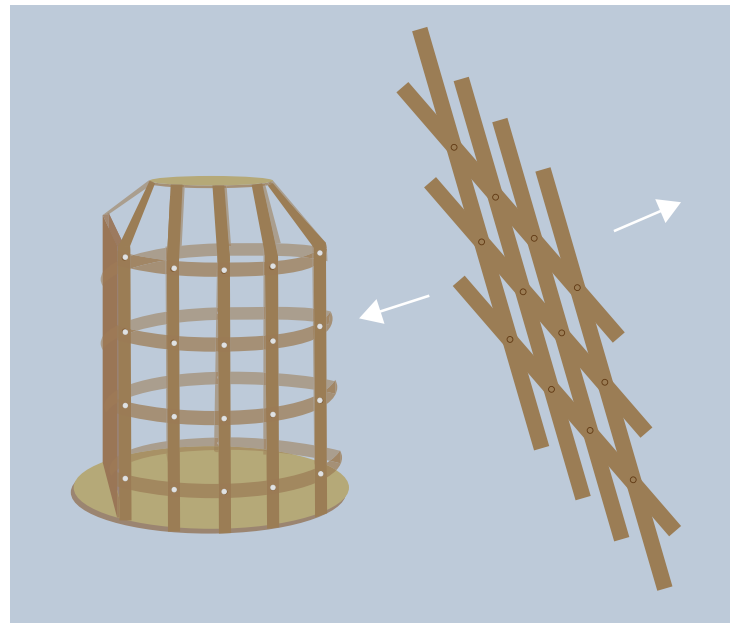

9 PLAN YOUR CIRCUIT

Attach the heart LEDboard to the ceiling piece, the batteryboard above the door and magnetic switch on the actual door piece. Connect them all with paper fasteners and conductive tape.



Paper



RGB Pictureframe

Watch as each panel of your artwork in the RGB Pictureframe lights up with the colors of red, blue and green.



Duration
25 mins

Difficulty Level



Parts and Materials

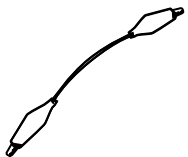

Alligator Clip
x1

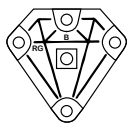

RGB
LEDboard
x1

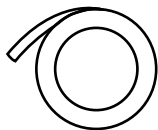

Conductive
Tape

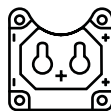

Battery
Board
x1



Coin Cell
Battery
x1

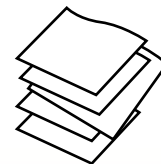

Paper



Cardboard

From the kit

Additional

1 MAKE THE FRAME

Split a piece of cardboard into 3 even panels, about 4 inches by 6 inches .

Cut out the middle of each panel to create a frame. Now fold those frames into triangle shape. Next, cut a triangle with glueable folds for the base of the frame.

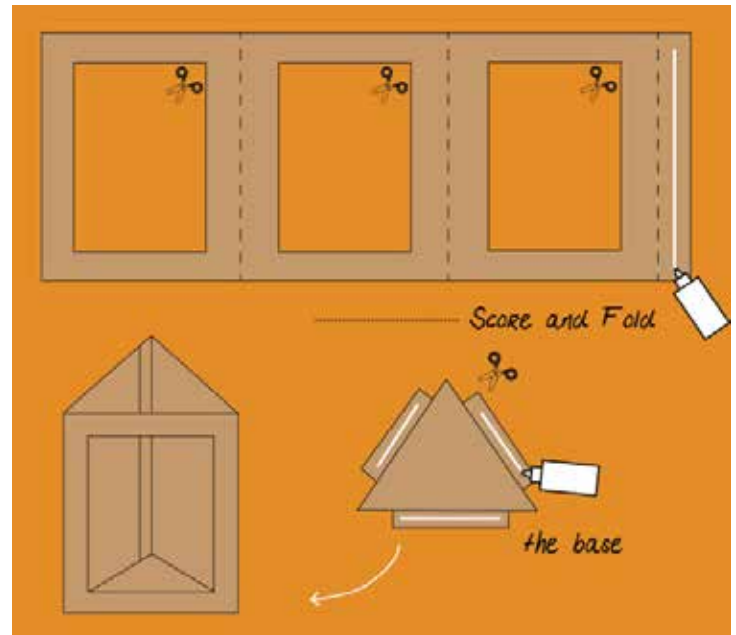

2 PLAN YOUR CIRCUIT

Position the LED and batteryboard on the base like on the image.

Then connect the negative pad of diamond LED with the negative pad on the batteryboard using conductive tape.

Next, connect each color on the LED to 3 different corners of the triangle. Make sure the tape pieces do not touch one another!

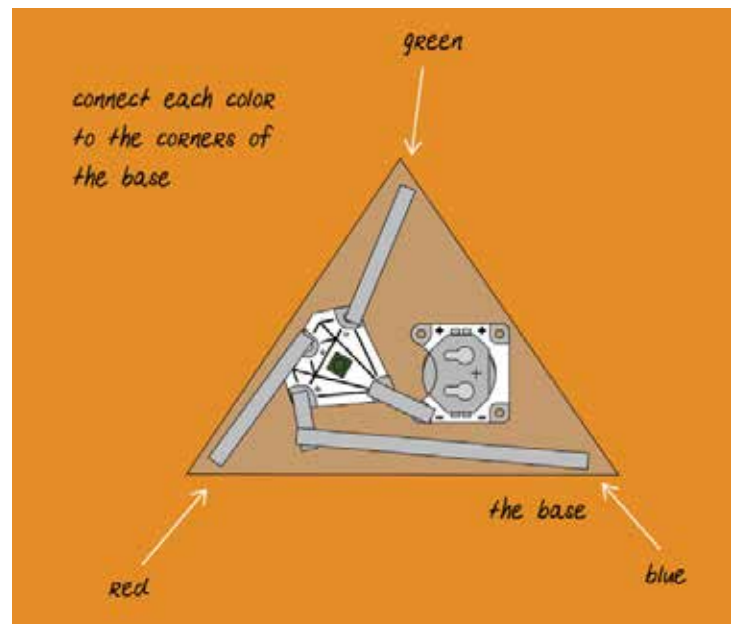

3 CONNECT RGB TO THE FRAME

Continue laying out tape from each corner, of the frame. Repeat it on all 3 frames. Now you have each panel connected to a different LED color.

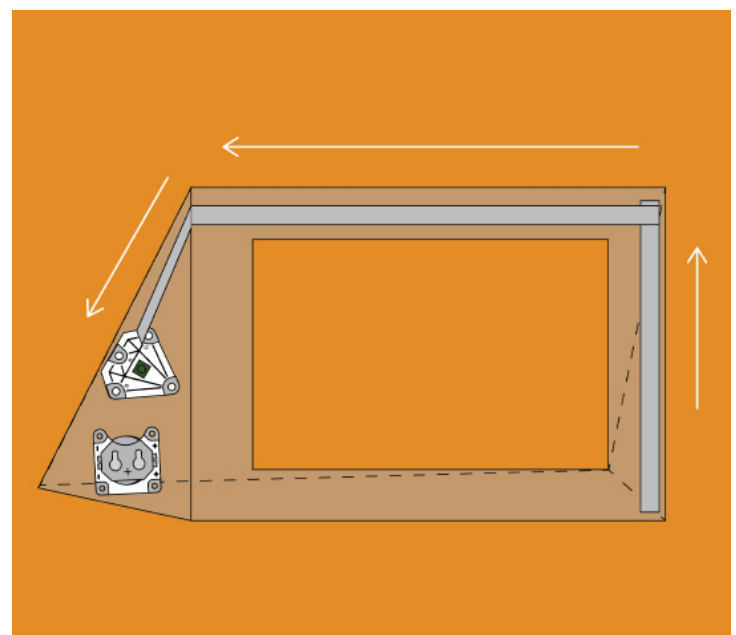

4 ADD ALLIGATOR CLIPS

Next, clip one end of the alligator clip to the positive side of the batteryboard. This will be your switch for the circuit.

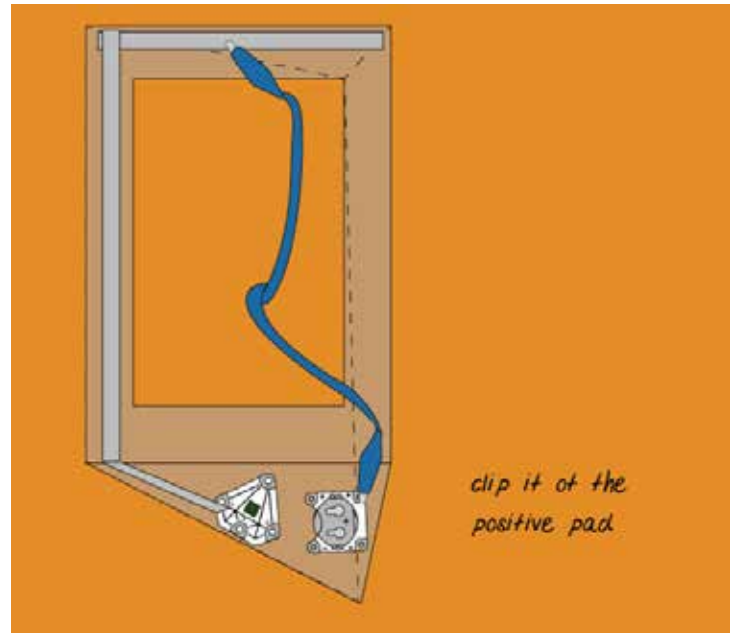

5 CREATE DRAWINGS TO FRAME

Cut the plain paper into a slightly bigger size from the frame. Then draw and decorate them anyway you like! You could also print pictures or photos.

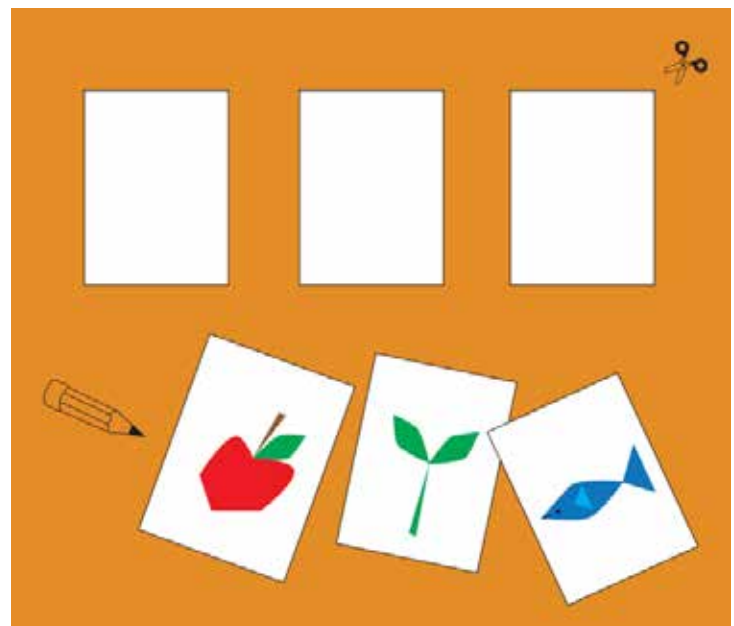

6 PLACE YOUR IMAGE

Place the images you just made into the 3 different panels. These can be changed anytime you want.

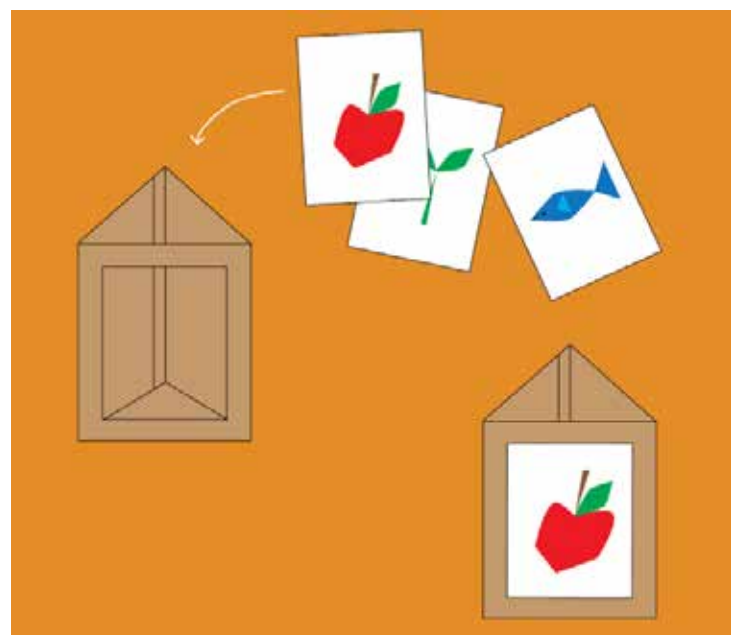

7 TEST YOUR CIRCUIT

Clip your Alligator clip on top of the frame, so that it is connected between two pieces of conductive tape. This will make the LED light up! Each frame will have a different colored light depending on which frame you clip! You can decorate your frame further. Be creative and have fun!



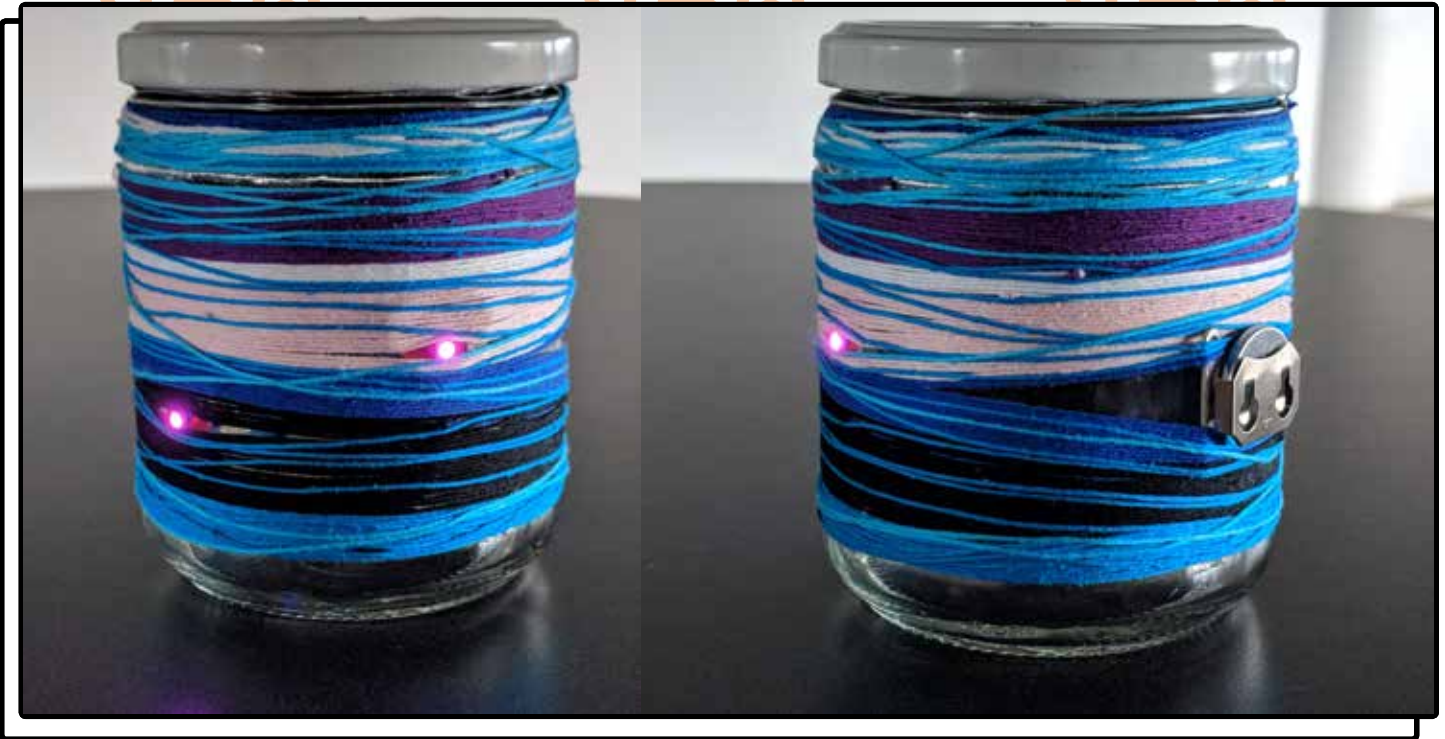

Embroidery Light Up Jar

Watch your jar come to life when putting the battery in the batteryboard for the LEDs to light up!



Duration
25 mins

Difficulty Level



Parts and Materials



Heart
LEDboard
x3

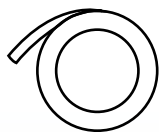

Conductive
Tape

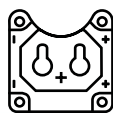

Battery
Board
x1



Coin Cell
Battery
x1



Glass Jar
x1

From the kit

Additional

4 PREP

Plan out your circuit. Make sure that all the positive pads will be connected and all the negative pads will be connected.

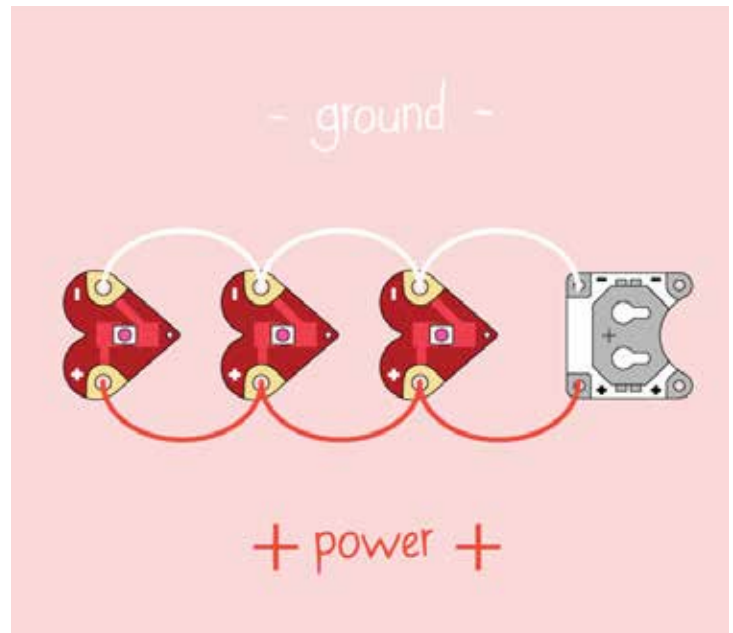

5 ADD CIRCUIT TO GLASS JAR

Place the circuit on the mason jar in the configuration you like (see "set up" for an example). Use conductive tape to connect the components.

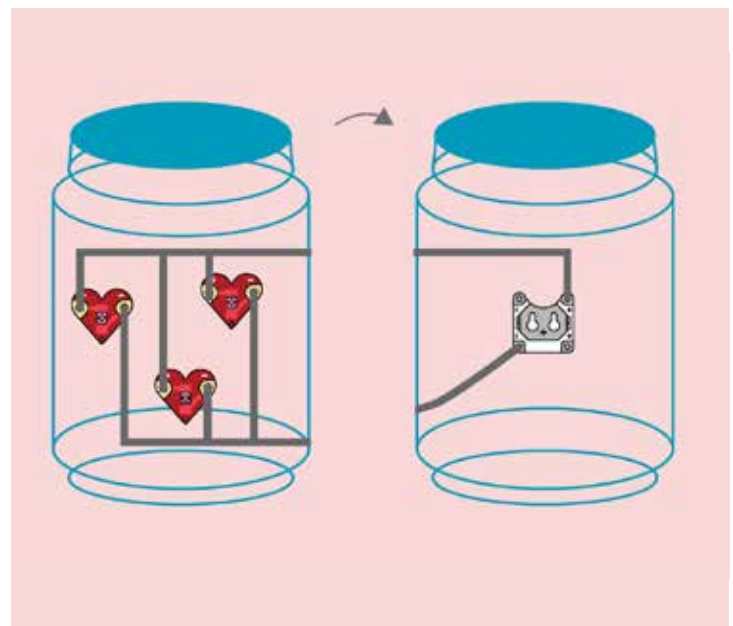

6 DECORATE YOUR JAR

Decorate the jar with embroidery floss by wrapping the embroidery floss around the jar or knitting a cozy around the jar.

Make sure to leave the lights and the battery slot exposed.



4 MAKE THE WRAPPING TIGHTER

Continue making embroidery floss tighter and as decorative as you wish.

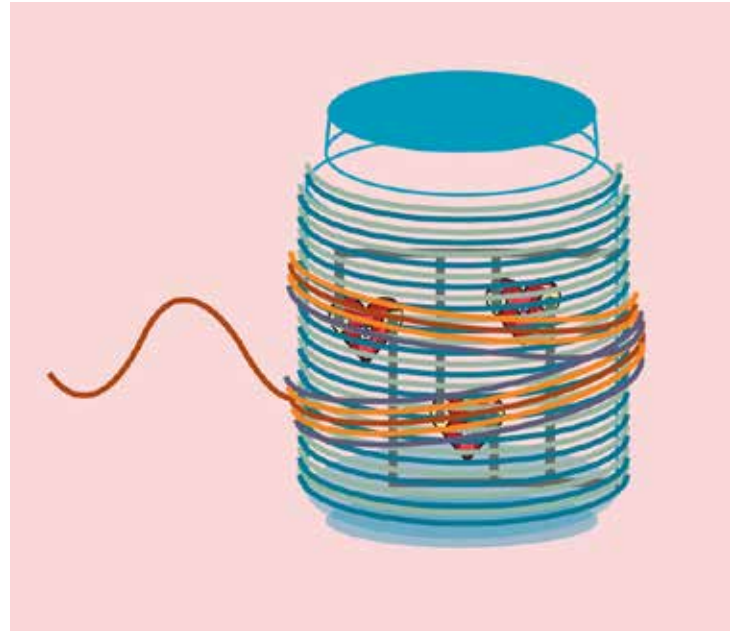

5 TEST OUT YOUR PROJECT

Insert the battery and see the jar light up!





Digital
Fabrication



Temperature Sensing Coaster

Put your drink on the Temperature Sensing Coaster, and watch the RGB LED turn red if the temperature sensor senses the object is hot and blue if the temperature sensor senses the object is cold!



Duration
25 mins

Difficulty Level



Parts and Materials

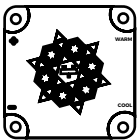

Temperature
Sensor
x1

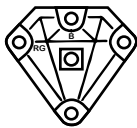

RGB
LEDboard
x1

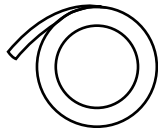

Conductive
Tape

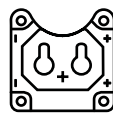

Battery
Board
x1



Coin Cell
Battery
x1

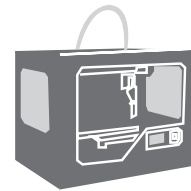

3D Printer

From the kit

Additional

1 PREP

Design and 3D print your coaster. Also don't forget to plan out and add designated places for the circuit elements.

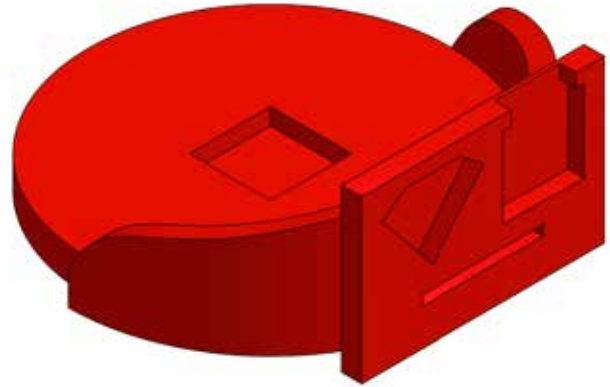

2 TEST YOUR CIRCUIT

Place the three main components into their respective compartments on the coaster. The components may need to be glued or taped into the compartments.

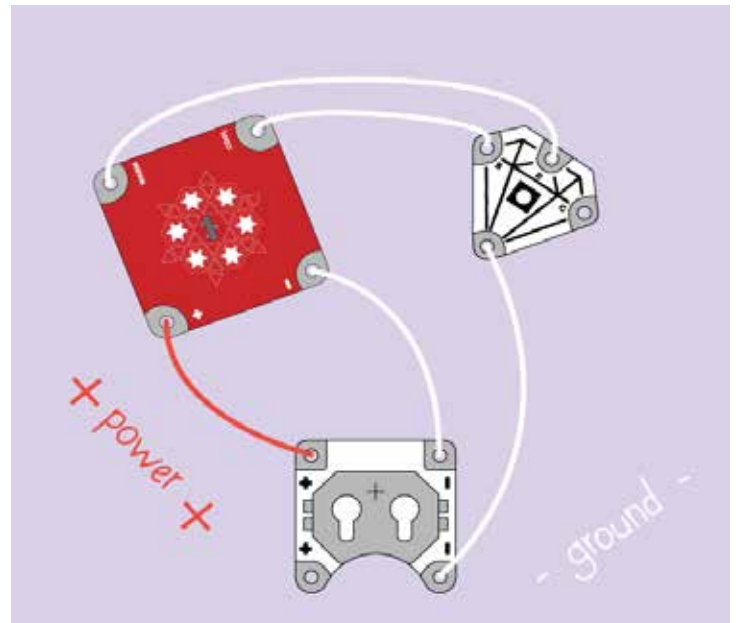

3 PLACE YOUR COMPONENTS

Connect the components using the conductive tape. Use the slit at the bottom of the coaster to connect the temperature sensor to the remaining components.

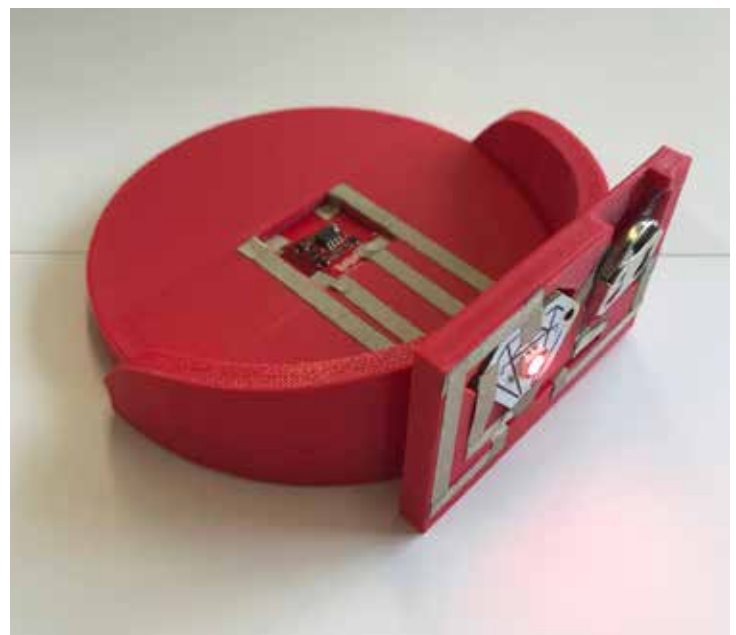

4 CONNECT EVERYTHING

Connect the components using the conductive tape. Use the slit at the bottom of the coaster to connect the temperature sensor to the remaining components.



5 TEST OUT YOUR PROJECT

Plug in a battery and place something warm on the coaster. You can use a mug with a hot drink like in the photo to the right. The temperature sensor reacts as a switch, which means if you cover the sensor, with something warm the diamond LED will light up red! But try out your sensor with something cold as well. In this case diamond LED will light up blue.





Wheel of Components

Upskill your circuitry and create a wheel that will come to life when it spins around a magnet!



Duration
25 mins

Difficulty Level



Magnetic
Reed Switch
x1



Motionboard
x1



Ghost
LEDboard
x1

Parts and Materials



Star
LEDboard
x1



Heart
LEDboard
x1



Conductive
Tape



Battery
Board
x1



Coin Cell
Battery
x1

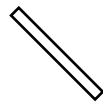

Dowel
x1



Magnet
x1



3D Printer

From the kit

Additional

1 PLAN YOUR CIRCUITS

Each component will be attached using a similar circuit:

Positive of batteryboard to positive of LED,
Negative of output to one magnet switch pad, negative of batteryboard to the other magnet switch pad.

The sides on magnetic switch are symmetric.

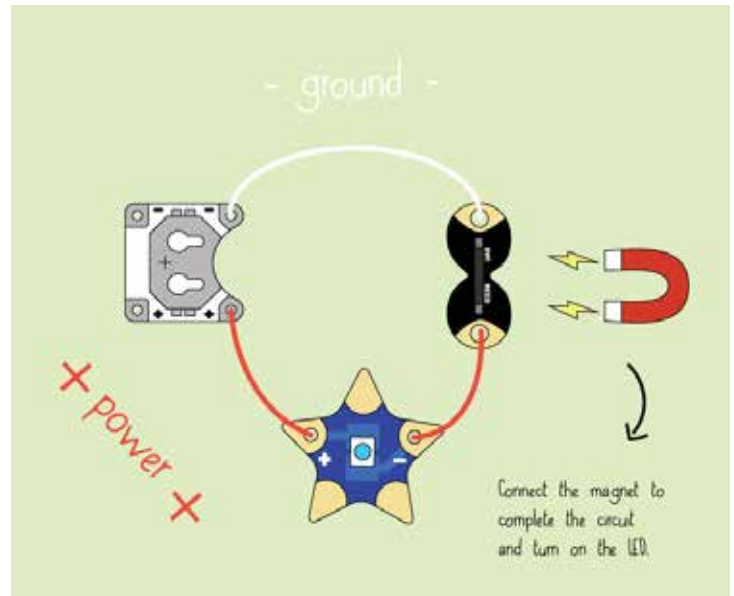

2 3D PRINT THE PARTS

3D print the arms of the wheel, which will fit into the center piece and hole each component. We designed an arm for each component. You will also print the center axle, with slots for each arm, spaces to hold the axle in place and base. You can find all of the 3D files here:

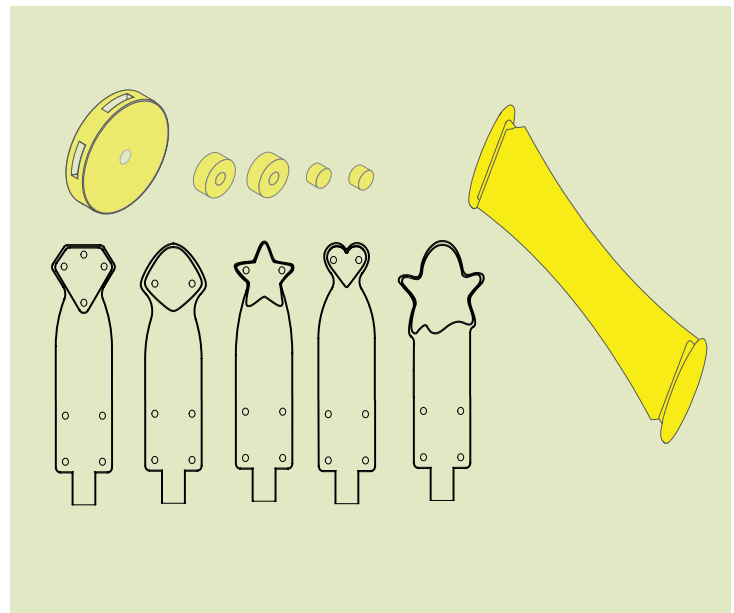

3 LASER CUT THE STAND

Laser cut the stand for the wheel. You can use plexiglass, stronger cardboard or plywood for that. You will find the files here:

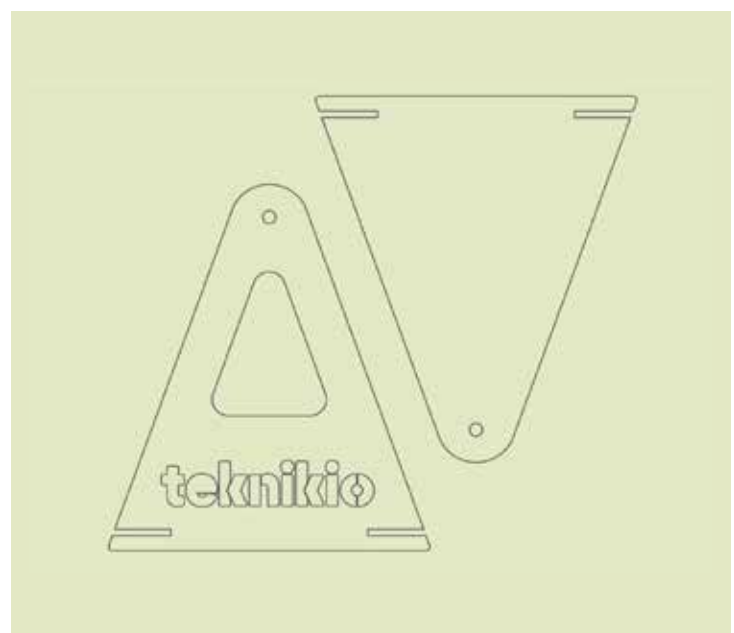

4 ATTACH THE CIRCUITS

Attach the boards to each holder and attach the circuits using conductive tape. Make sure to place the magnetic switches at the same spot on each arm.

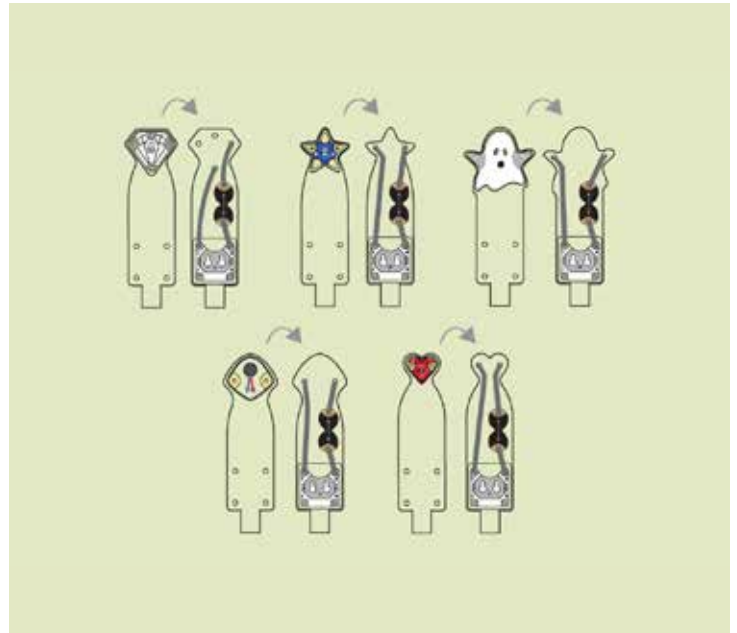

5 BUILD THE AXEL

Insert a dowel through the center of the wheel and put a spacer around each side.

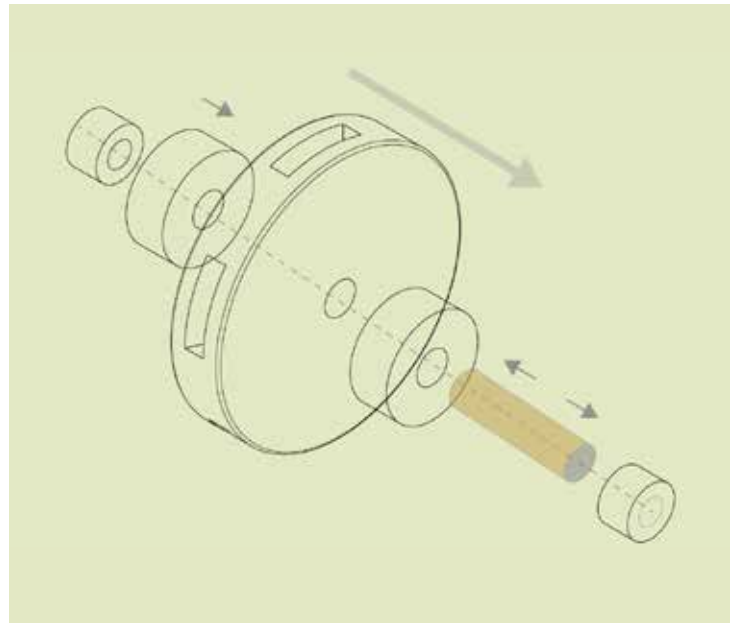

6 INSERT COMPONENT PIECES

Slot the arms with circuits to the center piece of the wheel.

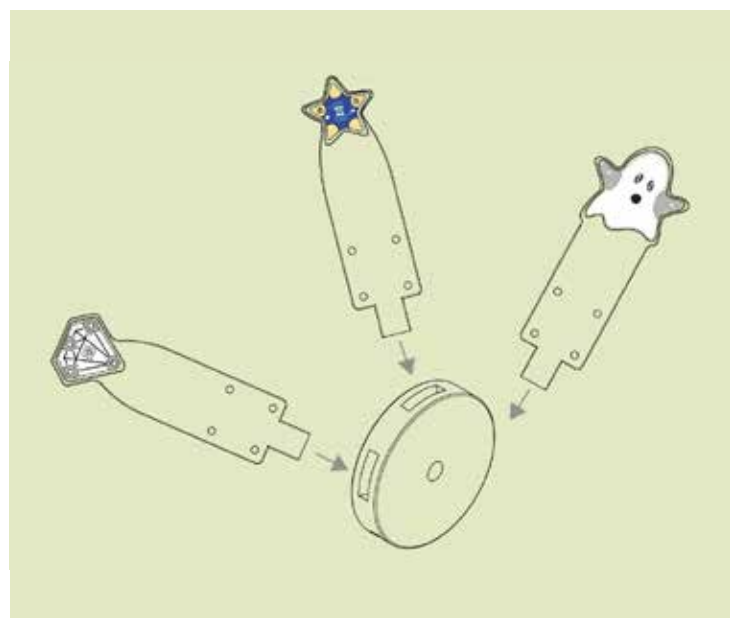

7 ASSEMBLE YOUR STAND

Place the 3D printed base parts in between the slots in the stand pieces, such the caps are holding them in place.

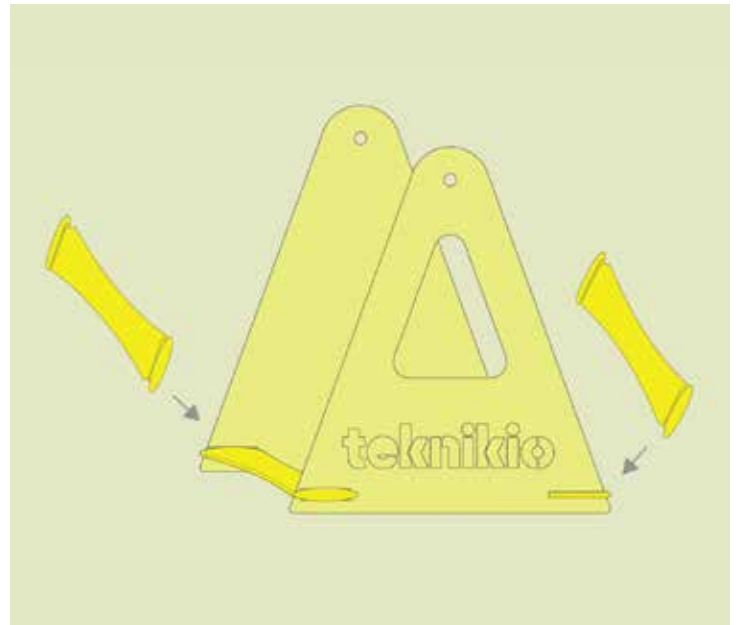

8 ATTACH WHEEL AND MAGNET

Place the dowel with the wheel through the holes on the top of the stand and put caps around the dowel to secure it in place. Attach the magnet to the middle of the back of the stand, in a position where the magnetic switch will pass it.

Now test out your project to make sure each component turns on as it passes by the magnet.

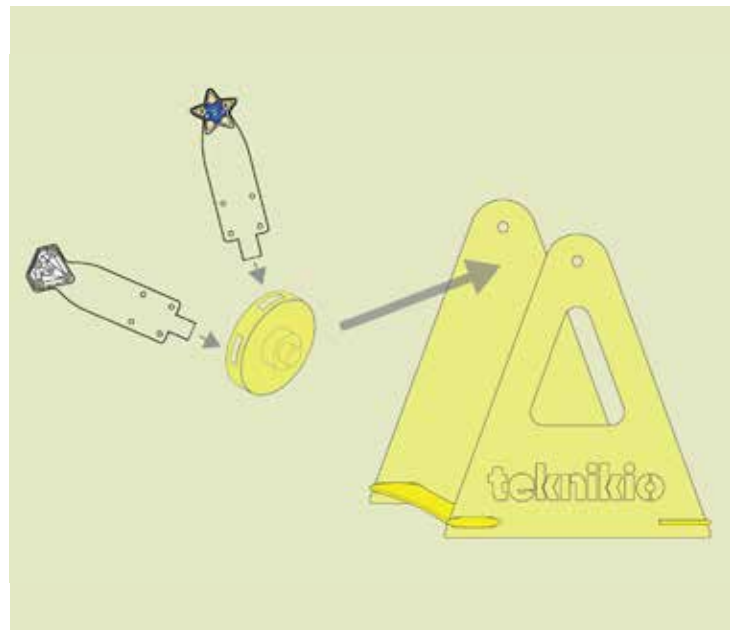

TROUBLESHOOTING

POWER

Check that your battery has enough charge to power the LED, buzzer or motor! If you have a voltmeter you can make sure the battery is above 2.5 volts. Check that your positive and negative connections do not cross or touch.

CONDUCTIVE THREAD

There are 2 common problems that can break the circuit. The first is that the positive and negative paths are crossing. Make sure none of your paths look like this:

The second common problem is a bad connection. This can happen anywhere your thread is connecting to a board or snap. Make sure all of these connections are tight and that the thread is making good contact with the silver surface on the boards and/or with the snaps.

You may need to take out and re-sew your connections. It may not be fun to re-sew your circuit, but it will be good practice.

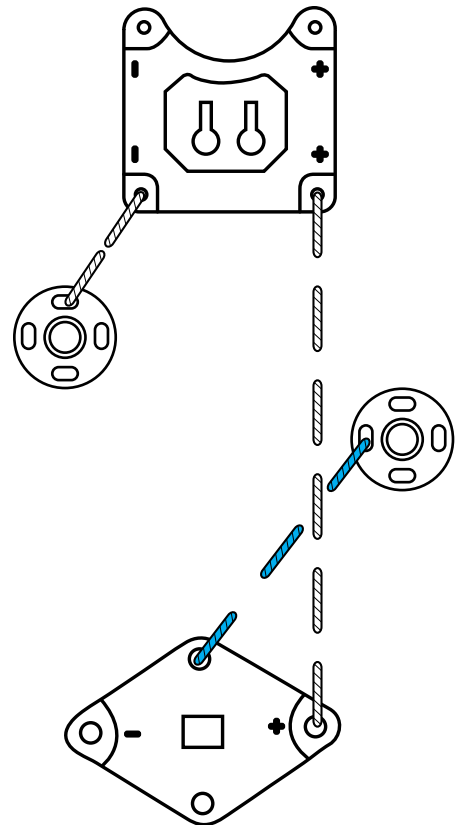

TROUBLESHOOTING

SHORT CIRCUITS

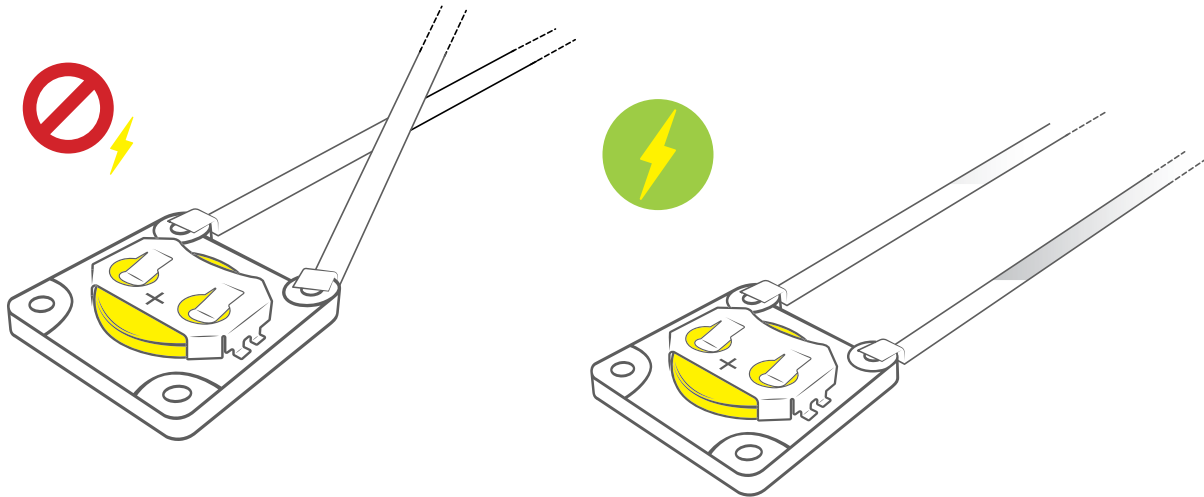

CONDUCTIVE TAPE

To make a corner pinch the tape at a 45 degree angle and turn the other side of the tape perpendicular like in the diagram above.

To "patch" 2 paths of tape you can take another piece of copper tape and place the non-sticky side across the gap you want to patch and then stick another piece over the top of it.

