

# *futura*

## **Aluminium Oil Radiator**

**FFR600-2    FFR900-2**

**FFR1500-2    FFR1800-2**

**User Manua**

Please read and  
retain for future  
reference



[www.futura direct.co.uk](http://www.futura-direct.co.uk)

This product is only suitable for well insulated spaces.

Search for  
*futura* *direct*

on You 

For in-depth  
user guides &  
tutorials

Follow Us @:





## Aluminium Oil Radiator

FFR600-2/ FFR900-2/ FFR1500-2/ FFR1800-2

Thank you for choosing our Futura Aluminium Oil radiator. Please be sure to read this users' manual carefully before using the unit. If you should encounter any problems, please contact a qualified service technician for help.

## CONTENTS

**Parts List**

**Technical Information**

**Safety Instructions**

**Using your Heater**

**Maintenance**

**Warranty**

## PARTS LIST

No.	Description	No.	Description
1	Left Plastic Panel	19	Power Supply PCB
2	Hex Nut	20	Screw
3	Left Fixed Panel	21	Power Switch
4	Left Connector	22	Protective Ring
5	Seal Ring	23	Screw
6	Aluminium Fins	24	Tension Disc
7	Right Connector	25	Power Cord
8	Right Fixed Panel	26	Screw
9	Screw	27	Sensor Fixed Part 1
10	Screw	28	Sensor Fixed Part 2
11	Self Reset Thermostat	29	Screw
12	Right Control Panel	30	Heating Element
13	Screw	31	Screw
14	Screen PCB	32	Top Bracket
15	Button	33	Screw
16	Button	34	Bottom Bracket
17	Transparency Sheet	35	Ground Ring
18	Board		

# futura

## Aluminium Oil Radiator

FFR600-2/ FFR900-2/ FFR1500-2/ FFR1800-2

### Exploded Assembly Diagram

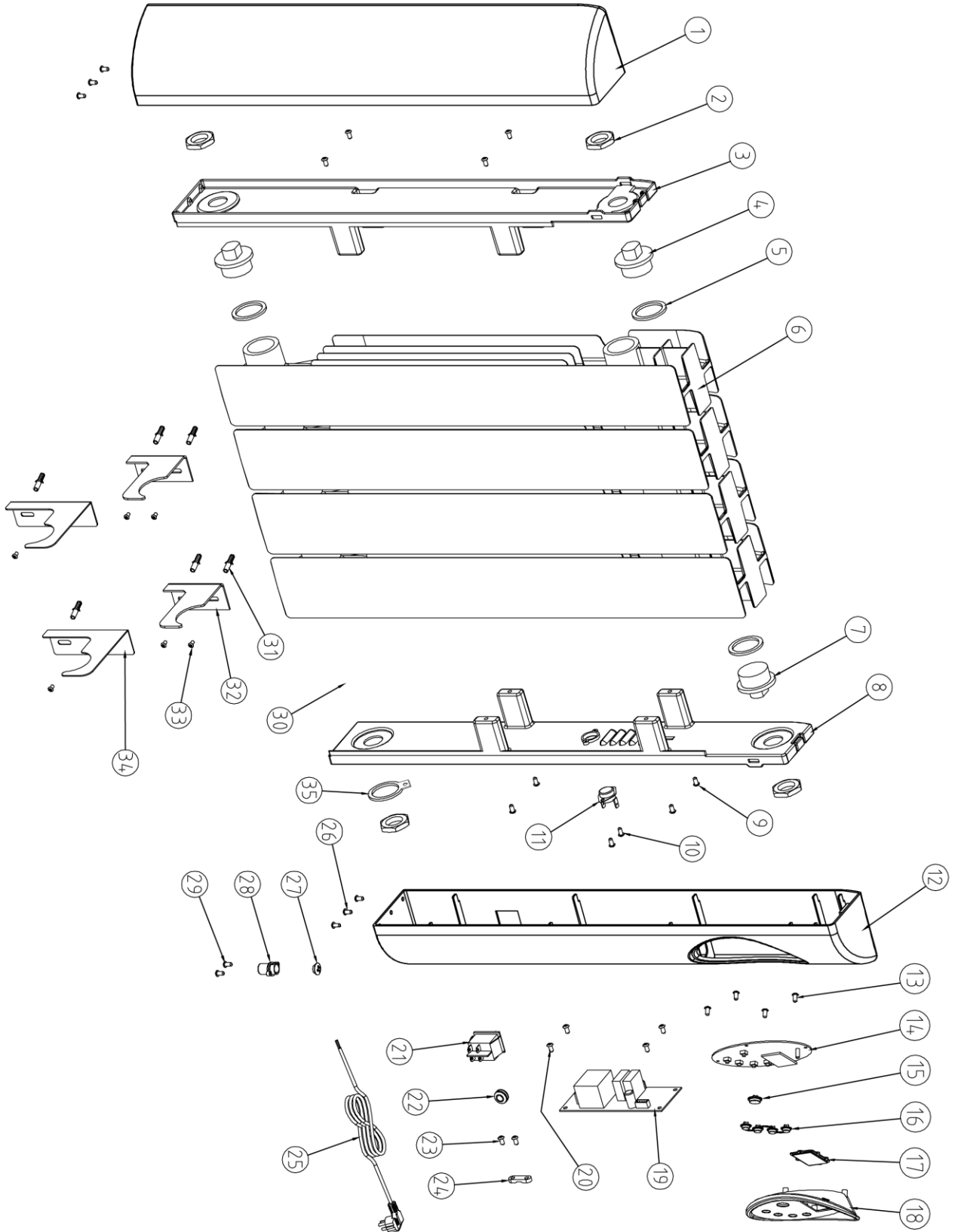

NOTICE: Actual product may vary from pictures shown.





## Aluminium Oil Radiator

FFR600-2/ FFR900-2/ FFR1500-2/ FFR1800-2

# TECHNICAL INFORMATION

### Aluminium Oil Radiator

**Model: FFR600-2**

Rated Voltage: 230V ~ 50Hz

Rated Power: 600W

Quantity of Fin: 4 fins

Machine Size (without feet): 490 x 590 x 80 mm (Length x Height x Width)

**Model: FFR900-2**

Rated Voltage: 230V ~ 50Hz

Rated Power: 900W

Quantity of Fin: 5 fins

Machine Size (without feet): 570 x 590 x 80 mm (Length x Height x Width)

**Model: FFR1500-2**

Rated Voltage: 230V ~ 50Hz

Rated Power: 1500W

Quantity of Fin: 8 fins

Machine Size (without feet): 810 x 590 x 80 mm (Length x Height x Width)

**Model: FFR1800-2**

Rated Voltage: 230V ~ 50Hz

Rated Power: 1800W

Quantity of Fin: 9 fins

Machine Size (without feet): 890 x 590 x 80 mm (Length x Height x Width)



**Read this entire manual before using this product. Failure to do so could result in serious injury. Save this manual for future reference.**

Copyright© 2019 by FUTURA Direct Ltd. All rights reserved. This manual or any artwork contained herein must not be reproduced in any shape or form without the express written consent of FUTURA Direct Ltd. Diagrams within this manual may not be drawn proportionally. Due to continuing improvements, actual product may differ slightly from the product described herein.



## Aluminium Oil Radiator

FFR600-2/ FFR900-2/ FFR1500-2/ FFR1800-2

# SAFETY INSTRUCTIONS

Read this owner's manual completely and make sure you understand all of its safety guidelines.

**WARNING!** To avoid electric shock or damage due to the heat, always make sure the plug is pulled out before the heater is moved or cleaned.

When using an electrical appliance, basic safety precautions should always be observed, including the following:

1. The product is for household and commercial use only.
2. Connect the appliance to single-phase AC supply of the voltage specified on the rating plate.
3. In order to avoid overheating do not cover the heater.
4. Caution is necessary when any heater is used by or near Children, invalids or elderly person and whenever the heater is left operating and unattended.
5. The heater must not be located immediately below an electrical Socket-outlet.
6. Do not run cord under carpeting and do not cover cord with throw rugs, runners or the like. Arrange cord away from any foot traffic area and place where it will not be tripped over.
7. Do not operate the heater with a damaged cord or plug, or after the heater malfunctions, has been dropped, or damaged in any manner.
8. If the supply cord is damaged, it must be replaced by the manufacturer, its service agent or a similarly qualified person in order to avoid a hazard.
9. Use the heater in a well-ventilated area. Do not insert or allow objects to enter any ventilation or exhaust opening. To prevent a possible fire, do not block air intakes or exhaust openings in any manner.
10. Do not use on soft surfaces, where openings may become blocked. Use the heater on flat, dry surfaces only.
11. Do not place this heater near flammable materials, surfaces or substances, as there may be a risk of fire. Keep the above flammable materials, surfaces or substances at least 1m from the front of the product and keep them away from the sides and rear.
12. Do not use the heater in any areas where petrol, paint or other flammable liquids are stored e.g. Garages or workshops as a hot, arcing or sparking parts inside the heater.
13. Don't use this heater in the immediate surroundings of a bath, a shower or a swimming pool (600mm clearance) with floor standing mode. Never locate the heater where it may fall into bathtub or other water container.
14. Never touch the heater with wet hand. The heater should be installed so that it can not be touched by a person using a bath or shower. (600mm clearance)
15. This heater is hot when in use. To avoid burns and personal injury, do not let bare skin touch hot surfaces.
16. Before moving the heater, please unplug it and let it cool down for 15 minutes. If provided, use handles when moving the product.
17. Please be aware that if other appliances are in use on the same electrical circuit as your product an overload can occur.
18. This appliance is not intended for use by persons (including children) with reduced physical, sensory or mental capabilities, or lack of experience and knowledge, unless they have been given supervision or instruction concerning use of the appliance by a person responsible for their safety.

19. Children should be supervised to ensure that they do not play with the appliance.

20. The radiator is equipped with ceramic heating element.

21. STORE THIS INSTRUCTION MANUAL FOR FUTURE USE!

### Unpacking

Carefully remove the product and any accessories from the box. Make sure that all items listed in the packing list are included.

### Packing List

A) Aluminium Oil Radiator

B) Manual

## USING YOUR HEATER

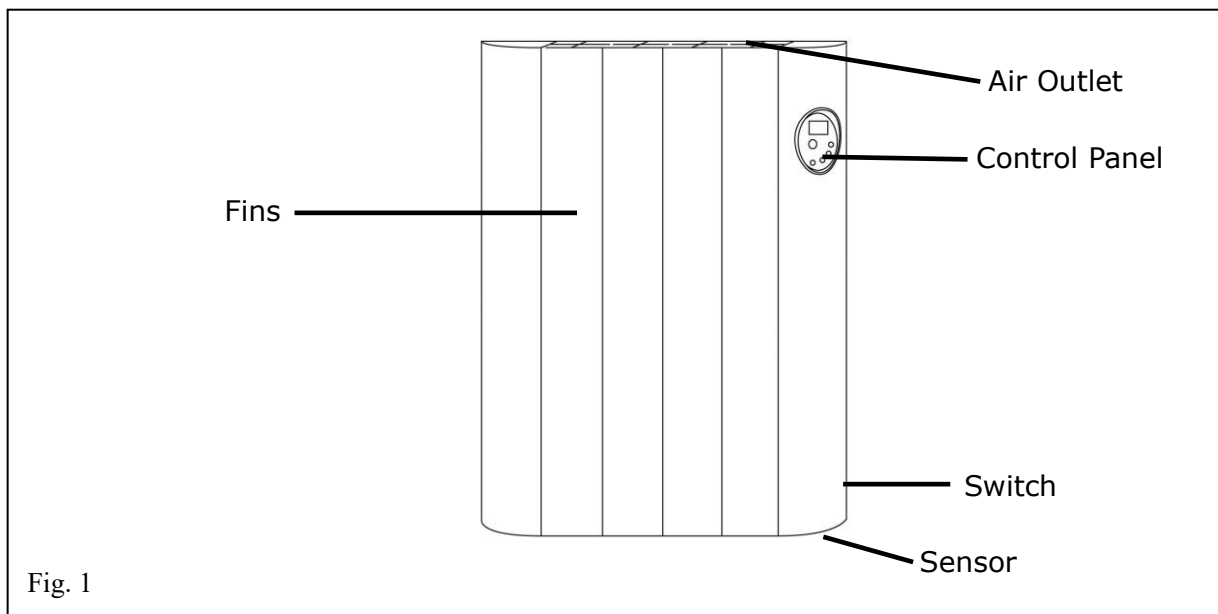

### OPERATION INSTRUCTION

**Please note: The screen has a backlight. It will stop lighting after 1 minute if you don't press any buttons. It will light up again once you press any button.**

**The unit has an auto button lock function. The buttons will be locked (🔒) after 1 minute if you don't press any buttons.**

**To open the lock: press  and  at same time.**

# futura

## Aluminium Oil Radiator

FFR600-2/ FFR900-2/ FFR1500-2/ FFR1800-2

### ASSEMBLY

#### For wall mounting

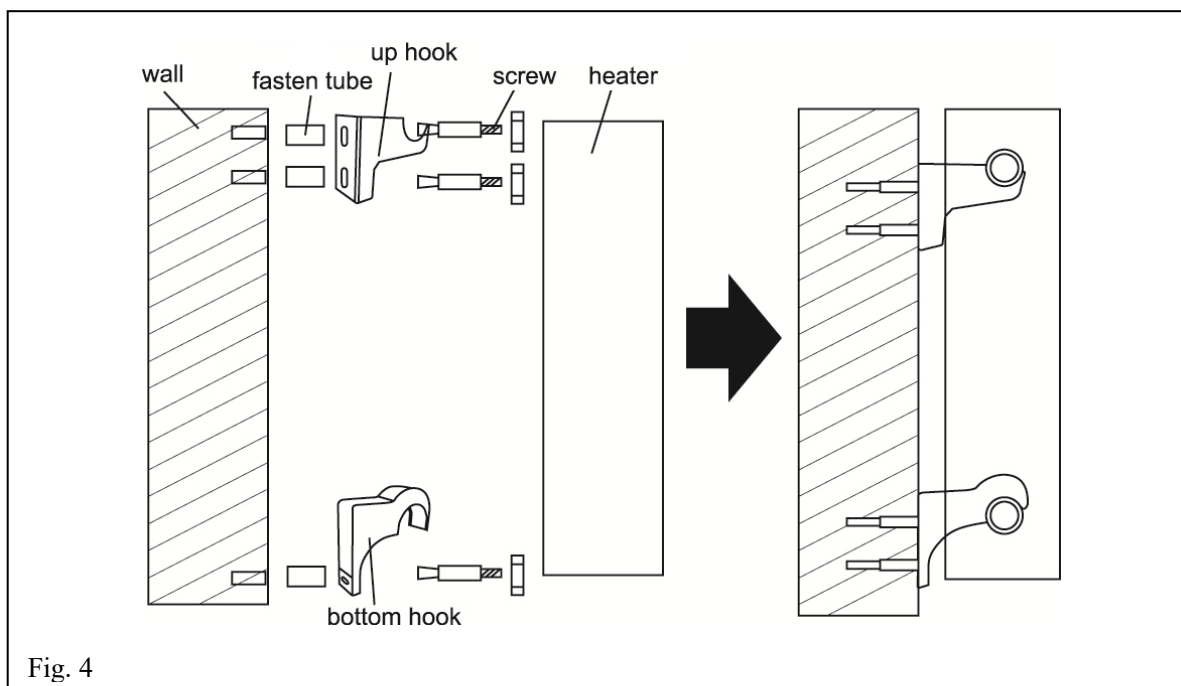
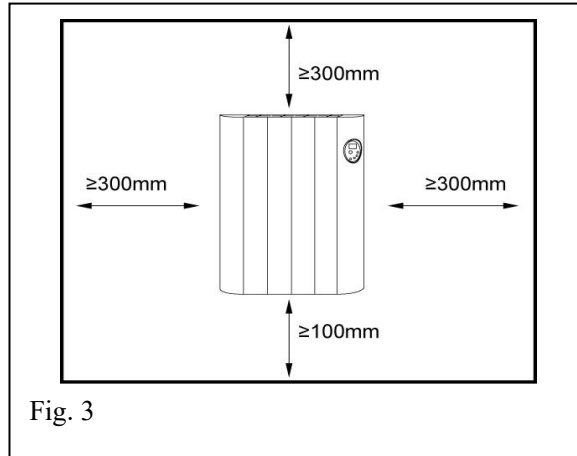
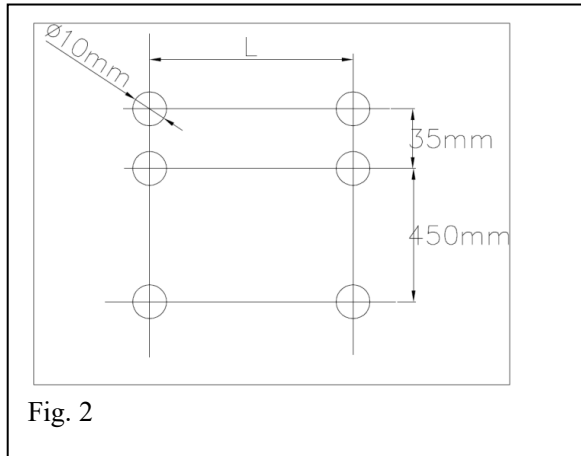

1. Drill holes on the wall according to the picture.

**Warning: Be sure to keep the distance between the heater and floor, wall and so on accordingly.**

2. Fit the fasten tube in the holes.
3. Fit the up-hook on the wall with screws.
4. Hang the unit on the up-hook.
5. Fit the bottom hook between 2 fins at the bottom of unit.
6. Fasten the bottom hook with screw.

The distance of hanging hole is as follows:





Model	FFR600-2	FFR900-2	FFR1500-2	FFR1800-2
L(mm)	160	240	480	560

**Warning:** Before using the heater make sure that it is mounted tightly on the wall. Damage may occur if it is placed on an incline or decline.

### Control panel and LCD screen

#### Control panel:

There are a total of 5 buttons on the control panel as follows:

-  --- Power standby switch
-  --- Date and time settings; Timer settings; Changes the working mode
-  --- Select running mode; Set program;
-  --- Increase
-  --- Decrease

#### Screen:

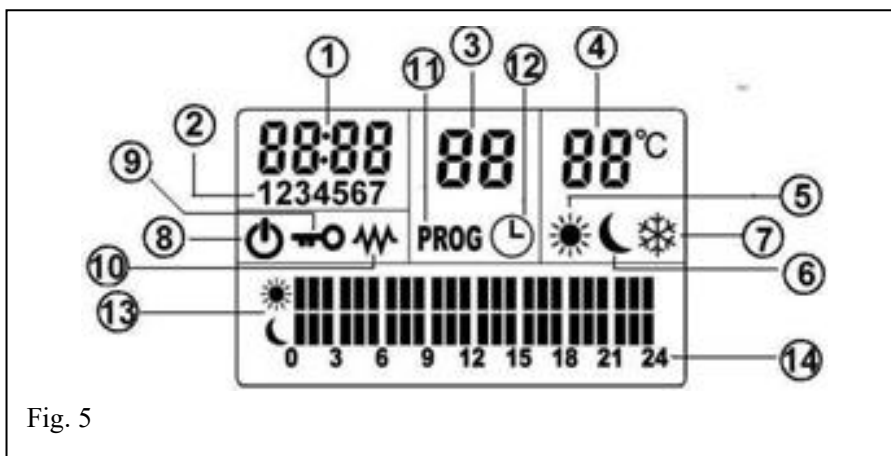

Fig. 5

- |                         |                     |
|-------------------------|---------------------|
| 1. Clock                | 8. Stand by         |
| 2. Date                 | 9. Buttons Lock     |
| 3. Program name/ number | 10. Heating symbol  |
| 4. Target temperature   | 11. Program setting |
| 5. Comfort              | 12. Timer           |
| 6. Economy              | 13. Day settings    |
| 7. Anti-frost           | 14. Hour of the day |

### Rationale

There are 3 running modes:

Free use/manual mode **Fr** , Daily program **P1 ~ P9** and weekly mode **RW**.

1. **Free use mode (Fr):** Includes normal mode and timer mode (⌚) ;

2. **Daily mode (P1 ~ P9):** There are a total of 9 daily programs.

Every program is a combination of the 3 working modes:

Comfort is represented by (☀ AND | ),

Economy is represented by (☾ AND | )

Anti-frost is represented by (❄ and empty).

Every day (24hours) is divided into 24 segments evenly. Each segment will be filled in with one block of either comfort, economy or anti frost temperature mode to combine and form a daily program.

All the settings for the daily program will be kept in the memory of the unit. If a daily program is selected, the unit will repeat this program every day.



3. **Weekly mode:**

Selecting one daily program (from the daily programs P1-P9) for every day in a week to combine and form a weekly program.

### Operation Instruction:

#### 1. Turning on

Plug in and switch on the unit. For the first time of use, the screen will show as per Fig.6.

Press  , then the  symbol will disappear and unit will go into free normal mode (note: units always go into free use normal mode from the stand-by mode).

#### 2. Operation

##### 2.1 Free program

For the first time of use, the screen will be shown as per Fig. 7.

##### 2.1.1 Time setting

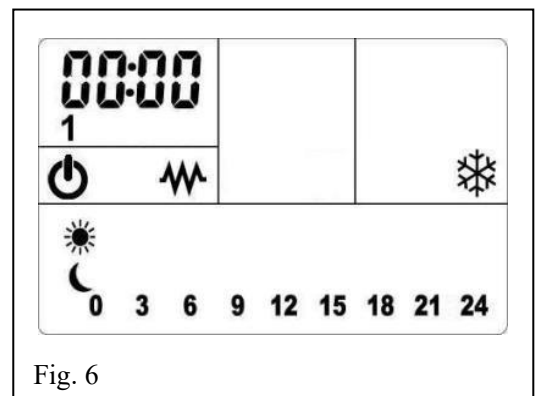

Fig. 6

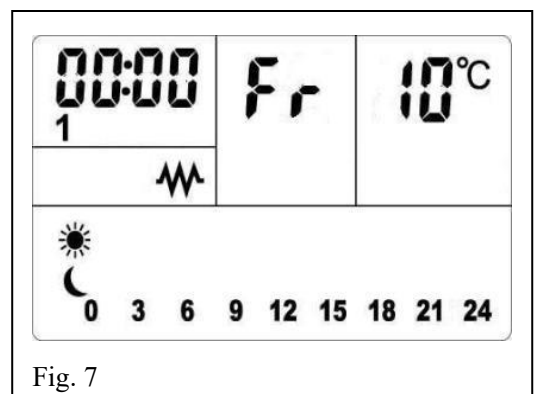









Fig. 7

Press  button and the hours will start to blink, then you can use  or  to select the required hour (0 ~ 23).

Press  again, and the minutes will start to blink.

Use  or  to select the minute (0 to 59);



Pressing  again, will make the date start to blink, then use  or  to select the date (1- Monday, 2- Tuesday, 3- Wednesday, 4- Thursday, 5- Friday, 6- Saturday, 7- Sunday);

Finally press  to confirm and finish the setting.

If there is no pressing, the blinking will stop after 5 seconds and the setting will be finished automatically.

### 2.1.2 Temperature setting

Press  or  to set the target temperature directly and at this point the temperature starts to blink.

Press  or  to set the target temperature.

Temperature range is from 10°C - 35°C.



If no buttons are pressed, the blinking will stop after 5 seconds and the setting will be finished automatically.

### 2.1.3 Timer setting (timer mode)

Hold  for 3 seconds until the  symbol is shown.

At the same time the clock will turn to 00:00 and start to blink.



This means the timer setting starts as per Fig. 8.

Press  or  to set the timer length, every button press will change half an hour (30 minutes).

The maximum timer length is 24 hours.

When the timer is over, the unit will enter into standby mode .

You can also set time and temperature the same as 2.1.1 and 2.1.2.

To quit from timer mode: hold the  button for 3 seconds until the  symbol has disappeared.

The unit will automatically return back to free normal mode afterward.

(Note: Once the machine exits free program (enter the day, week program, or standby), and then return to the free program, the unit always enters into the free normal mode first. The original timing mode will be automatically cancelled).

## 2.2 Running mode selecting

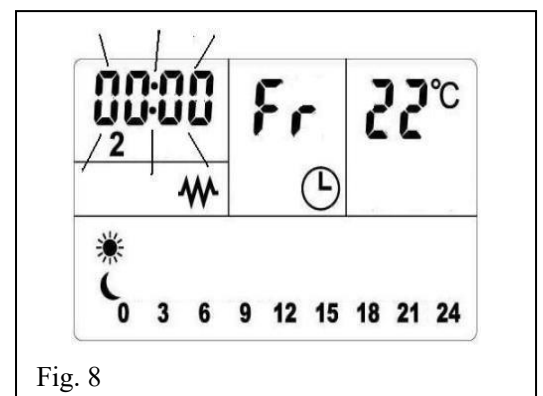

Fig. 8

Press the  button to get into program selecting (Program No. start to blink).



Press  or  to select running mode: *Fr*, *P1-P9*, *AU*.



Then press  to confirm it. The unit will run following the new selection program.

Note: During this period, if no buttons are pressed, the selection is automatically completed 5 seconds later.

### 2.3 Day program

Day program has three kinds of working modes:

Comfort mode : (  and program content displayed as  ), Adjustable range from 10 °C ~ 35 °C;

Economic mode: (  and program content displayed as  ), Adjustable range of 10 °C ~ 35 °C;

The temperature should be no higher than comfort temperature;

Anti-frost mode: (  and program content displayed empty), 7 °C is fixed.

If a daily program was chosen for the work program, the unit will repeat the program every day.

Different programs used for the first time as follows (Fig.9-17):

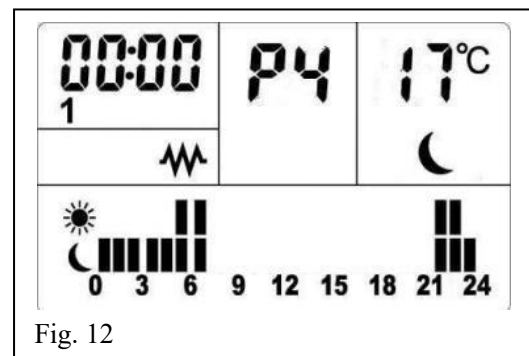
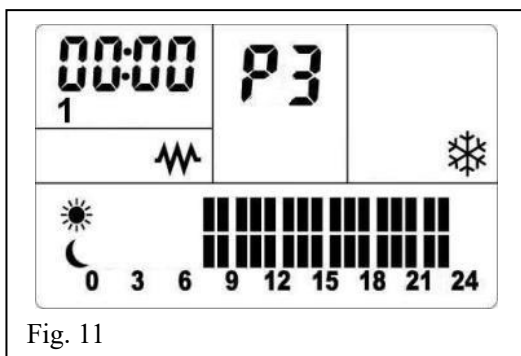
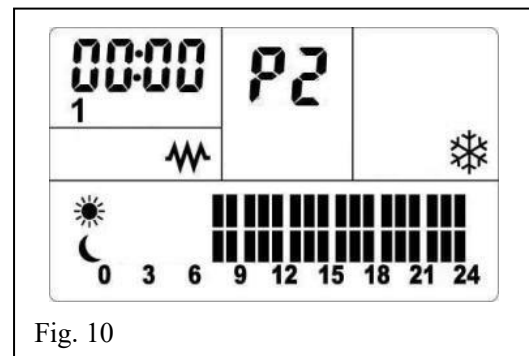
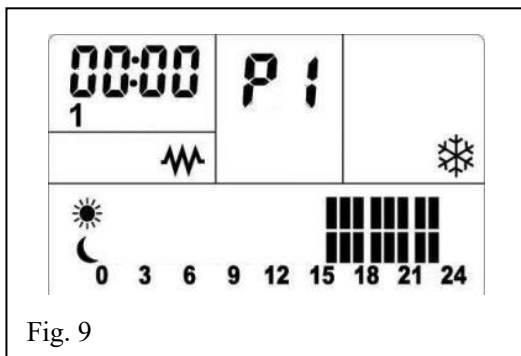



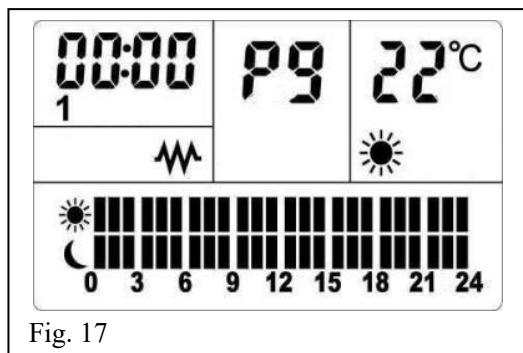
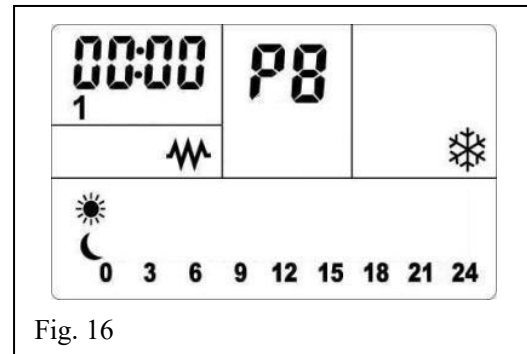
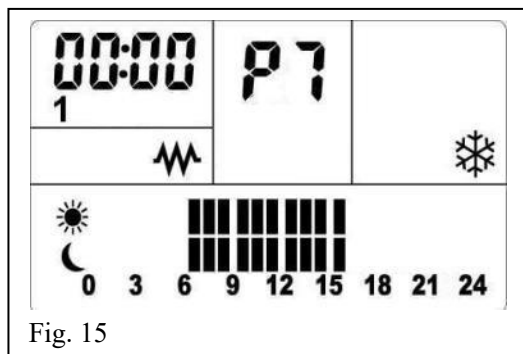
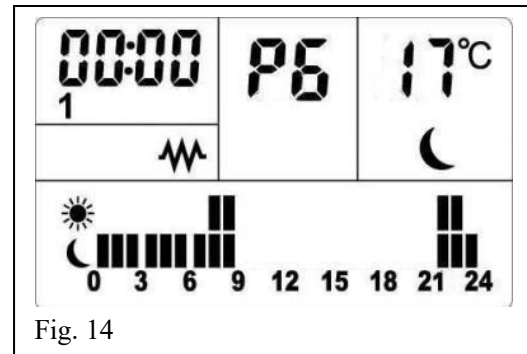
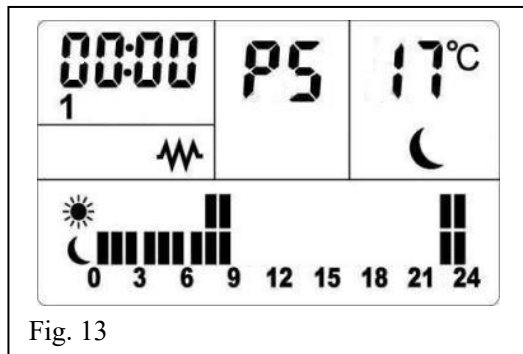

### 2.3.1 Time setting



Same as 2.1.1, then the unit will automatically adjust to the current time and running accordingly.

### 2.3.2 Temperature setting

Hold the  button for 3 seconds until the  symbol blinks, at the same time the original comfort temperature will start to blink.

Press  or  buttons to set the target comfort temperature.

Press  to confirm, and the  symbol will start to blink, the original economy temperature also starts to blink.

Press the  or  buttons to set the target economy temperature.

Use  to confirm, temperature setting is completed, the unit will come back to run under comfort mode.

The temperature will then be kept into the memory.

### 2.3.3 Setting Daily program

#### Amending a pre-set program to your set times

Press the  button to choose the program from **P1 ~ P9** that you want to set.

Then hold the  button for 3 seconds to enter the program setting and at this time **PROG** will be displayed on the screen.

**PROG** Will be shown until the setting is completed, and the heating will stop during the setting.

The date does not show and the time is 00:00.

The mark  starts to blink rapidly.

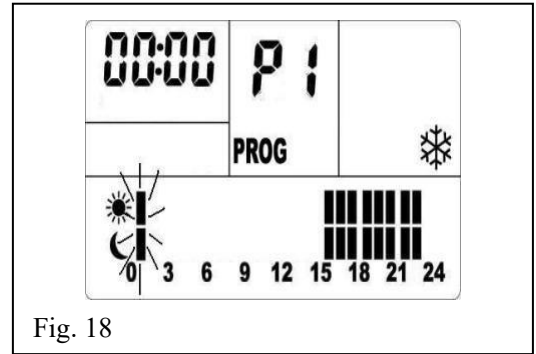

Fig. 18

First segment of selected program, such as Fig.18 (when the selected daily program is P1).

 starts the mode,   for comfort;  Economy;  empty for the anti-frost.

Then press  (forward), or  (back) to copy the mode into every segment.

Finally press  to confirm the program and exit program setting.

**PROG** Will disappear and the unit comes back to normal working mode.

The new program will be kept in the memory and replace the original program.

### 2.4 Weekly program

You may select week program according to 2.2.

The first use will be as per Fig. 19.

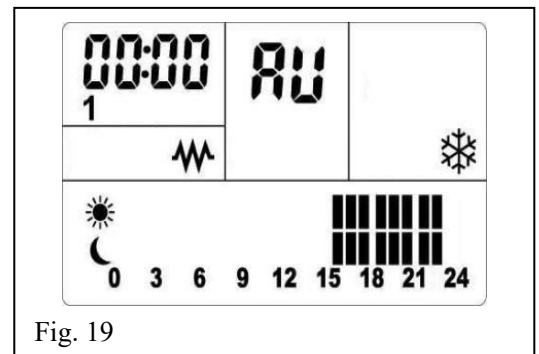

Fig. 19

#### 2.4.1 Time setting

Same as 2.1.1, then the unit will automatically adjust to the current time and run accordingly.

#### 2.4.2 Temperature setting

Same as 2.3.2.

#### 2.4.3 Setting weekly program

Hold  for 3 seconds to enter the weekly program setting, the time and working mode are no longer displayed, and **PROG** is shown.

**PROG** is displayed until the setting has finished, the unit stops heating during the setting.

The Monday marker will begin to blink, the program name of Monday will also blink (the corresponding program content also shows).

The screen shows as Fig. 20.

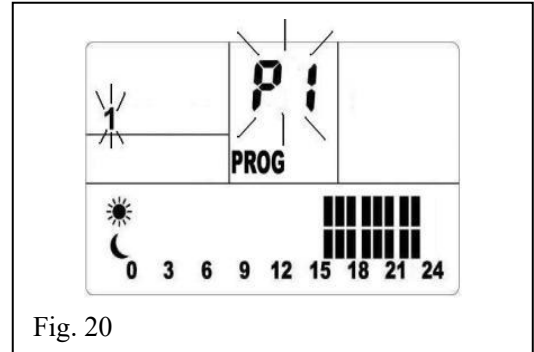

Fig. 20

Press either or to select the daily program from P1~P9 for Monday (1).

Press to confirm and automatically enter the Tuesday program (2).

**With same method you can select a daily program for every day in a week.**

Finally press to complete the week program settings.

Then the **PROG** symbol will disappear and the unit will run according to new weekly program.

Note: Settings can be terminated at any time during setting. The new content will be retained.

### 3. OPEN WINDOW Function:

Your radiator is equipped with the function fenestrata open. (open window mode)

When you open the windows for a length of time, in the part where the radiator is located, a sensor detects the sharp fall of the temperature. The radiator switches off automatically and the symbol **FO**, Flickers on your screen.

The radiator is restarted automatically after 10 minutes.

However you can manually restart the radiator before the 10 minutes end by pressing on the button of the radiator. The symbol "FO" disappears then of the screen.

#### 3.1 Starting of the function:

1. Press once. Using the keys and , choose **FO F1 P1~P9 AU FO** among

Then press once to confirm your choice.

2. Once in the program fenestrata open, See Fig. 21 the screen appears.

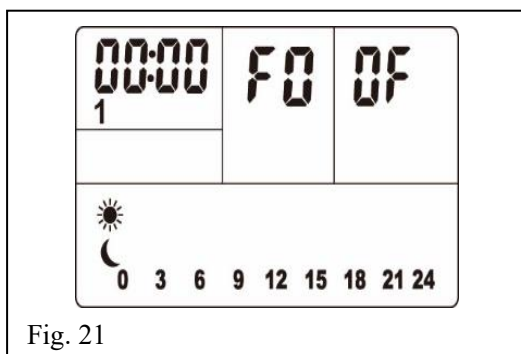

Fig. 21

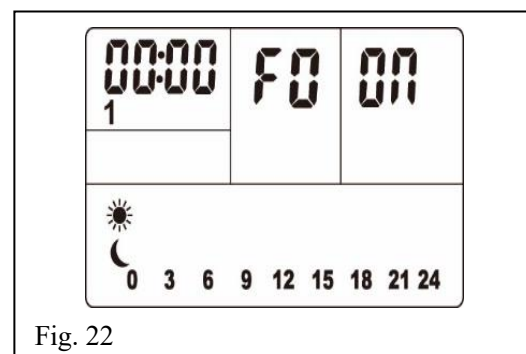

Fig. 22

OF meaning “function not in operation”

Using the keys  and , to change OF into ON, (ON meaning “function is in operation”) See

Fig. 22.

The function fenestrate open is then operational.

Press  once to validate your choice. Without pressing the touch button  during 5 seconds,

the function is validated automatically.

#### 4. Factory pre-sets

The unit has a factory pre-set as follows:

Date: 1 (Monday)

Clock: 00:00

Anti-frost: 7 °C

Free mode temperature: 10 °C

Comfort: 22 °C

Economy: 17 °C

Weekly Program:

1 ~ 5 (Mon-Fri): P1

6 (Saturday): P2

7 (Sunday): P3

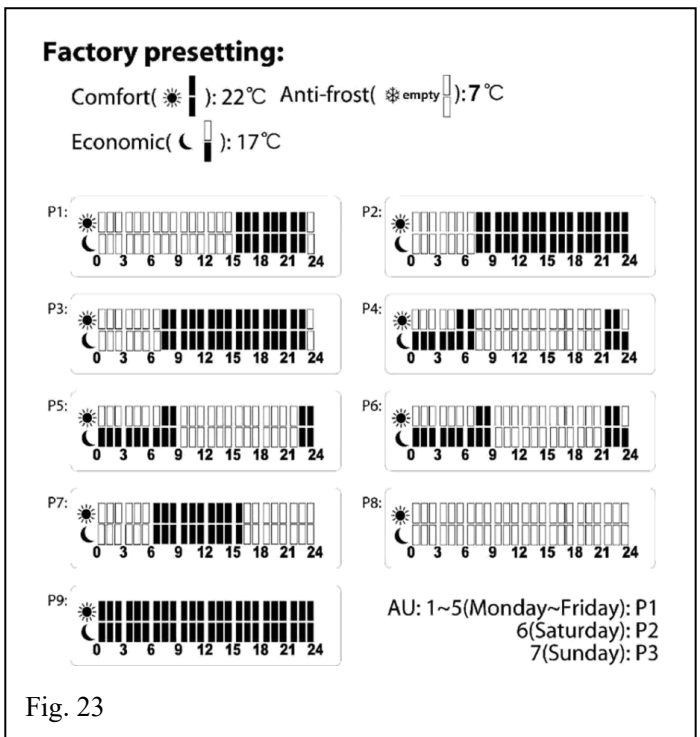



Fig. 23

Note: When pressing  to power on, the unit will come back on to the factory pre-sets.

#### 5. Other notes

1. The screen has a back light. It will turn off after 1 minute if you don't press any buttons. It will light up again if you press any button.

2. The unit has a button lock function. The buttons will be locked () after 1 minute if you don't press any buttons.

To open lock: press  and  at same time.

3. Time will be reset to **00:00** if you unplug the unit, or if there is a power cut.

4. This heater includes an overheat protection system that shuts off the heater when parts are getting excessively hot.

# futura

## Aluminium Oil Radiator

FFR600-2/ FFR900-2/ FFR1500-2/ FFR1800-2

5.  will only show when the unit is heating.
6. The unit will always go into free use mode from standby mode.
7. The unit will return to last running mode when powered off and on.

## MAINTENANCE

1. For cleaning, always unplug the heater and leave it to cool.  
Wipe the heater regularly with a damp cloth and dry the surface before turning on the heater again.
3. The heater must be cleaned at least once a month during the heating season.
4. Dust etc. should be removed with a soft cloth.
5. The heater can be stored in a dry and clean place.

**CAUTION! The heater should never be immersed in water.**

**Avoid using detergents to clean the heater.**

**Never let any water get inside the heater; this can be hazardous.**

### Disposal

Power tools, accessories and packaging should be sorted for environmentally-friendly recycling.

**Only for EC countries:**



Do not dispose of power tools into household waste!

According to the European Directive 2002/96/EC on waste electrical and electronic equipment and its incorporation into national right, products that are no longer suitable for use must be separately collected and sent for recovery in an environmentally-friendly manner.



## Aluminium Oil Radiator

FFR600-2/ FFR900-2/ FFR1500-2/ FFR1800-2

# DECLARATION OF CONFORMITY

The declaration is to certify that it conforms to CE, EMC, LVD and RoHS directives:

EN55014-1: 2017

EN55014-2: 2015

EN61000-3-2: 2014

EN61000-3-3: 2013

All provisions of Annex 1 of Council Directive 2014/30/EU – EMC directive

EN60335-1: 2012 + A11: 2014 + A13: 2017

EN60335-2-30: 2009 + A11: 2012

EN62233: 2008

All provisions of Annex 1 of Council Directive 2014/35/EU – the Low Voltage Directive

RoHS 2011/65/EU



Mr. Paul Kaye, UK QA Manager

**Please read the following carefully**

FUTURA Direct Ltd. and/or its distributor have provided the parts list and assembly diagram as a reference tool only.

Neither FUTURA Direct Ltd. or its distributor makes any

representation or warranty of any kind to the buyer that he or she is qualified to do any repairs or replace any parts of this product. FUTURA Direct Ltd. and its distributor expressly state that all repairs or parts replacement should be done by certified or licensed technicians. The buyer assumes all risk and liability arising out of his or her repairs or parts replacement to the original product.

## 24 MONTHS LIMITED WARRANTY

If within 24 months from the date of purchase you experience any problems with your product, please return the product to its distributor/dealer for repair or replacement. This warranty DOES NOT COVER normal wear, or any damage as a result of accidents, misuse, abuse or negligence.



## Aluminium Oil Radiator

FFR600-2/ FFR900-2/ FFR1500-2/ FFR1800-2

### Form 1: Information requirement for the electric local space heaters

Model identifier(s): NDH988CK-4 (FFR600-2)					
Item	Symbol	Value	Unit	Item	Unit
<b>Heat Output</b>				<b>Type of heat input, for electric storage local space heaters only (select one)</b>	
Nominal heat output	$P_{nom}$	0.60	kW	manual heat charge control, with integrated thermostat	No
Minimum heat output (indicative)	$P_{min}$	0.60	kW	manual heat charge control with room and/or outdoor temperature feedback	No
Maximum continuous heat output	$P_{max,c}$	0.60	kW	electronic heat charge control with room and/or outdoor temperature feedback	No
<b>Auxiliary electricity consumption</b>				fan assisted heat output	
At nominal heat output	$e_{l_{max}}$	N/A	kW	<b>Type of heat output/room temperature control (select one)</b>	
At minimum heat output	$e_{l_{min}}$	N/A	kW	single stage heat output and no room temperature control	No
In standby mode	$e_{l_{SB}}$	N/A	kW	Two or more manual stages, no room temperature control	No
				with mechanic thermostat room temperature control	No
				with electronic room temperature control	No
				electronic room temperature control plus day timer	No
				electronic room temperature control plus week timer	Yes
				<b>Other control options (multiple selections possible)</b>	
				room temperature control, with presence detection	No
				room temperature control, with open window detection	Yes
				with distance control option	No
				with adaptive start control	No
				with working time limitation	No
				with black bulb sensor	No
Contact details	Applicant Name: IMPORTED BY FUTURA DIRECT LTD. Address: DONCASTER,ENGLAND,DN6 7AY				



## Aluminium Oil Radiator

FFR600-2/ FFR900-2/ FFR1500-2/ FFR1800-2

### Form 2: Information requirement for the electric local space heaters

Model identifier(s): NDH988CK-5 (FFR900-2))					
Item	Symbol	Value	Unit	Item	Unit
<b>Heat Output</b>				<b>Type of heat input, for electric storage local space heaters only (select one)</b>	
Nominal heat output	$P_{nom}$	0.9	kW	manual heat charge control, with integrated thermostat	No
Minimum heat output (indicative)	$P_{min}$	0.9	kW	manual heat charge control with room and/or outdoor temperature feedback	No
Maximum continuous heat output	$P_{max,c}$	0.9	kW	electronic heat charge control with room and/or outdoor temperature feedback	No
<b>Auxiliary electricity consumption</b>				fan assisted heat output	
At nominal heat output	$e_{lmax}$	N/A	kW	<b>Type of heat output/room temperature control (select one)</b>	
At minimum heat output	$e_{lmin}$	N/A	kW	single stage heat output and no room temperature control	No
In standby mode	$e_{lsb}$	N/A	kW	Two or more manual stages, no room temperature control	No
				with mechanic thermostat room temperature control	No
				with electronic room temperature control	No
				electronic room temperature control plus day timer	No
				electronic room temperature control plus week timer	Yes
				<b>Other control options (multiple selections possible)</b>	
				room temperature control, with presence detection	No
				room temperature control, with open window detection	Yes
				with distance control option	No
				with adaptive start control	No
				with working time limitation	No
				with black bulb sensor	No
Contact details	Applicant Name: IMPORTED BY FUTURA DIRECT LTD. Address: DONCASTER,ENGLAND,DN6 7AY				





## Aluminium Oil Radiator

FFR600-2/ FFR900-2/ FFR1500-2/ FFR1800-2

### Form 3: Information requirement for the electric local space heaters

Model identifier(s): NDH988CK-9 (FFR1500-2)					
Item	Symbol	Value	Unit	Item	Unit
<b>Heat Output</b>				<b>Type of heat input, for electric storage local space heaters only (select one)</b>	
Nominal heat output	$P_{nom}$	1.5	kW	manual heat charge control, with integrated thermostat	No
Minimum heat output (indicative)	$P_{min}$	1.5	kW	manual heat charge control with room and/or outdoor temperature feedback	No
Maximum continuous heat output	$P_{max,c}$	1.5	kW	electronic heat charge control with room and/or outdoor temperature feedback	No
<b>Auxiliary electricity consumption</b>				fan assisted heat output	
At nominal heat output	$e_{l_{max}}$	N/A	kW	<b>Type of heat output/room temperature control (select one)</b>	
At minimum heat output	$e_{l_{min}}$	N/A	kW	single stage heat output and no room temperature control	No
In standby mode	$e_{l_{SB}}$	N/A	kW	Two or more manual stages, no room temperature control	No
				with mechanic thermostat room temperature control	No
				with electronic room temperature control	No
				electronic room temperature control plus day timer	No
				electronic room temperature control plus week timer	Yes
				<b>Other control options (multiple selections possible)</b>	
				room temperature control, with presence detection	No
				room temperature control, with open window detection	Yes
				with distance control option	No
				with adaptive start control	No
				with working time limitation	No
				with black bulb sensor	No
Contact details	Applicant Name: IMPORTED BY FUTURA DIRECT LTD. Address: DONCASTER,ENGLAND,DN6 7AY				



## Aluminium Oil Radiator

FFR600-2/ FFR900-2/ FFR1500-2/ FFR1800-2

### Form 4: Information requirement for the electric local space heaters

Model identifier(s): NDH988CK-10 (FFR1800-2)					
Item	Symbol	Value	Unit	Item	Unit
<b>Heat Output</b>				<b>Type of heat input, for electric storage local space heaters only (select one)</b>	
Nominal heat output	$P_{nom}$	1.8	kW	manual heat charge control, with integrated thermostat	No
Minimum heat output (indicative)	$P_{min}$	1.8	kW	manual heat charge control with room and/or outdoor temperature feedback	No
Maximum continuous heat output	$P_{max,c}$	1.8	kW	electronic heat charge control with room and/or outdoor temperature feedback	No
<b>Auxiliary electricity consumption</b>				fan assisted heat output	
At nominal heat output	$e_{lmax}$	N/A	kW	<b>Type of heat output/room temperature control (select one)</b>	
At minimum heat output	$e_{lmin}$	N/A	kW	single stage heat output and no room temperature control	No
In standby mode	$e_{lsb}$	N/A	kW	Two or more manual stages, no room temperature control	No
				with mechanic thermostat room temperature control	No
				with electronic room temperature control	No
				electronic room temperature control plus day timer	No
				electronic room temperature control plus week timer	Yes
				<b>Other control options (multiple selections possible)</b>	
				room temperature control, with presence detection	No
				room temperature control, with open window detection	Yes
				with distance control option	No
				with adaptive start control	No
				with working time limitation	No
				with black bulb sensor	No
Contact details	Applicant Name: IMPORTED BY FUTURA DIRECT LTD. Address: DONCASTER,ENGLAND, DN6 7AY				

[www.futura direct.co.uk](http://www.futura-direct.co.uk)

We FUTURA Direct Ltd, England DN6 7AY declare that the Aluminium Oil Radiator is exclusively manufactured for FUTURA Direct Ltd and has been manufactured according to our fully quality assurance procedures.