



## LED Digital Panel Heater

GPH1B

GPH15B

GPH2B

WGPH1

WGPH15

WGPH2

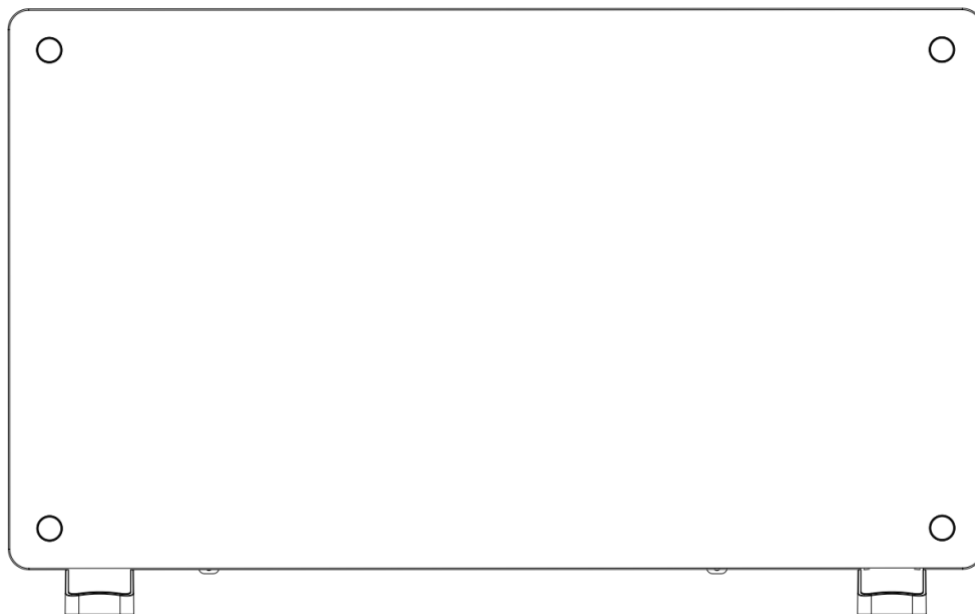

**REGISTER YOUR GUARANTEE**

[www.futura-direct.co.uk/guarantee](http://www.futura-direct.co.uk/guarantee)

## Important!

- **NEVER TOUCH YOUR HEATER OR ITS CASING WITH WET HANDS!**
- **DO NOT COVER THE HEATER!**

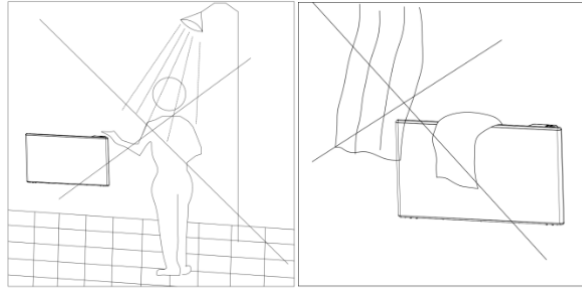

- When using any electrical device, be sure to follow basic safety precautions in this instruction manual.

## General safety instructions





- **PLEASE READ THE FOLLOWING INSTRUCTIONS CAREFULLY BEFORE USING THE APPLIANCE.**
- Check that the mains voltage corresponds to that of the device.
- Do not use the appliance if the cable is damaged.
- Keep this unit and its cord away from sources of heat, sharp objects, or anything that could damage it.
- If the supply cord is damaged, it must be replaced by the manufacturer, its service agent or similarly qualified persons in order to avoid a hazard.
- Before connecting the unit to the power supply, make sure that the switch is “Off”.
- Turn off the power and isolate it from the power supply before cleaning .
- Always place the unit on a stable, level surface and use it in an upright position.
- Do not operate the unit in areas where gasoline, paint or other flammable liquids may be used or stored.
- For indoor use only.
- To prevent a fire, do not block the air inlet and outlet in any way.

- Do not touch hot surfaces.
- Do not insert or allow foreign objects to enter any ventilation or exhaust opening as this will cause electric shock or fire and damage the unit.
- Always make sure your hands are dry before adjusting any switch or touching the unit.
- This appliance can be used by children aged from 8 years and above and persons with reduced physical, sensory or mental capabilities or lack of experience and knowledge if they have been given supervision or instruction concerning use of the appliance in a safe way and understand the hazards involved. Children shall not play with the appliance. Cleaning and user maintenance shall not be made by children without supervision.
- Children of less than 3 years should be kept away unless continuously supervised.
- **CAUTION — Some parts of this product can become very hot and cause burns. Particular attention has to be given where children and vulnerable people are present.**
- The main cause of overheating is due to dust deposits or residues in the unit. Make sure these foreign bodies are removed regularly. Isolate the unit from the power supply and clean it by vacuuming the air inlet and the grilles.
- The heater must not be located immediately below a socket-outlet.
- When the product is used as fixed heater: The heater is to be installed so that switches and other controls cannot be reached by a person in a bath or shower.
- When the product is used as portable heater:
  - Do not use this heater in the immediate surroundings of a bath, a shower or a swimming pool;
  - Do not use this heater if it has been dropped;

- Do not use if there are visible signs of damage to the heater;
- Use this heater on a horizontal and stable surface, or fix it to the wall, as applicable.
- **WARNING:** Do not use this heater in small rooms when they are occupied by persons not capable of leaving the room on their own, unless constant supervision is provided.
- **WARNING:** To reduce the risk of fire, keep textiles, curtains, or any other flammable material a minimum distance of 1 m from the air outlet.



- **WARNING: In order to avoid overheating, do not cover the heater.**
- For the information of installation and maintenance, refer to the “INSTALLATION” section and “MAINTENANCE” section.
- Do not use the unit with a separate timer, separate remote-control system, or any other device that automatically turns on the unit, as there is a risk of fire if the unit is covered or placed incorrectly.
- **WARNING!** In order to avoid any danger due to the accidental reset of the thermal circuit breaker, the device must not be powered via an external switch, such as a timer, or be connected to a circuit which is regularly switched on and off by the electricity supplier.
- The appliance must not be disposed of with household waste; it must be brought to a local center for the recovery and recycling of electrical appliances.
- When installing the radiator, you must ensure that the electrical cable does not come into contact with the metal casing of the heater.

	Complies with European regulations applying to the product.
	<b>WARNING:</b> In order to avoid overheating, do not cover the heater.
 	Electrical products should not be disposed of with household waste. Please recycle them at the collection points provided for this purpose. Contact the local authorities or your dealer for recycling advice.

## Description of the heater

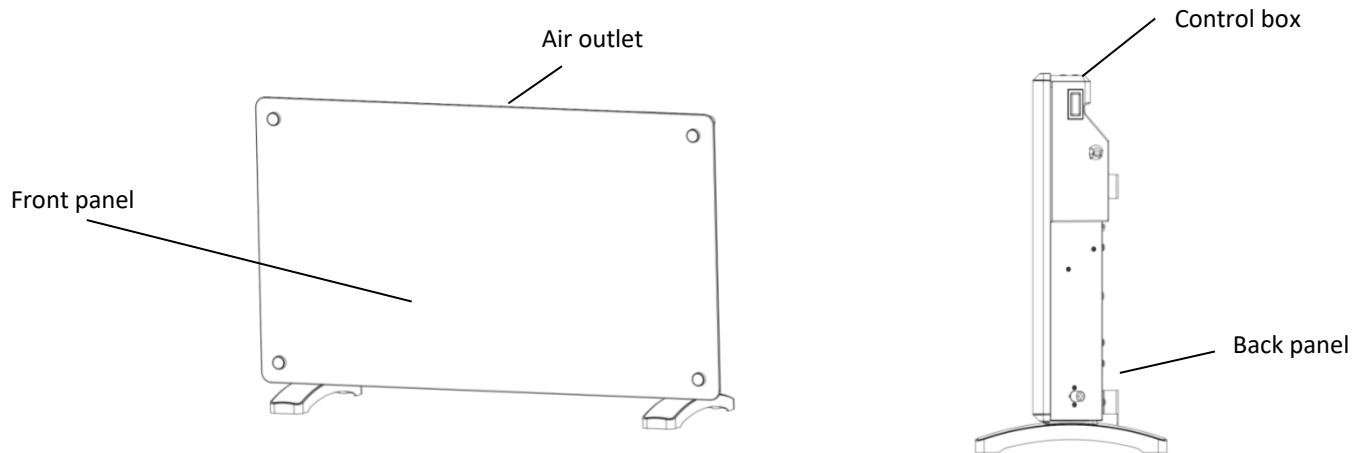

## Technical characteristics

- Digital LED display
- Temperature setting: 5 ~35°C
- 24 hours timer
- 7 days weekly programs
- Open window function
- Anti-frost function: Maintain the temperature at 7°C

Model	Color	Voltage	Power	IP rating
GPH1B	Black	230 V / 50 Hz	1000W	IP24
GPH15B	Black	230 V / 50 Hz	1500W	IP24
GPH2B	Black	230 V / 50 Hz	2000W	IP24
WGPH1	White	230 V / 50 Hz	1000W	IP24
WGPH15	White	230 V / 50 Hz	1500W	IP24
WGPH2	White	230 V / 50 Hz	2000W	IP24

# Installation

## • Use as standing

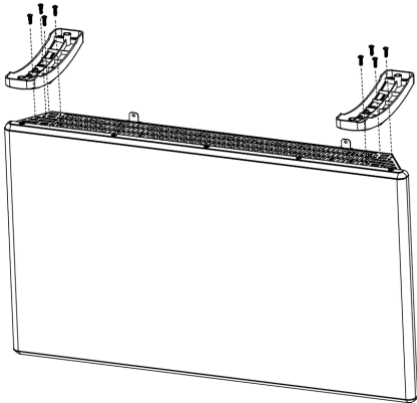

- 1 – Fit the feet onto the bottom of the body.
- 2 – Fasten the feet with 4 screws provided.

## • Wall Mounted

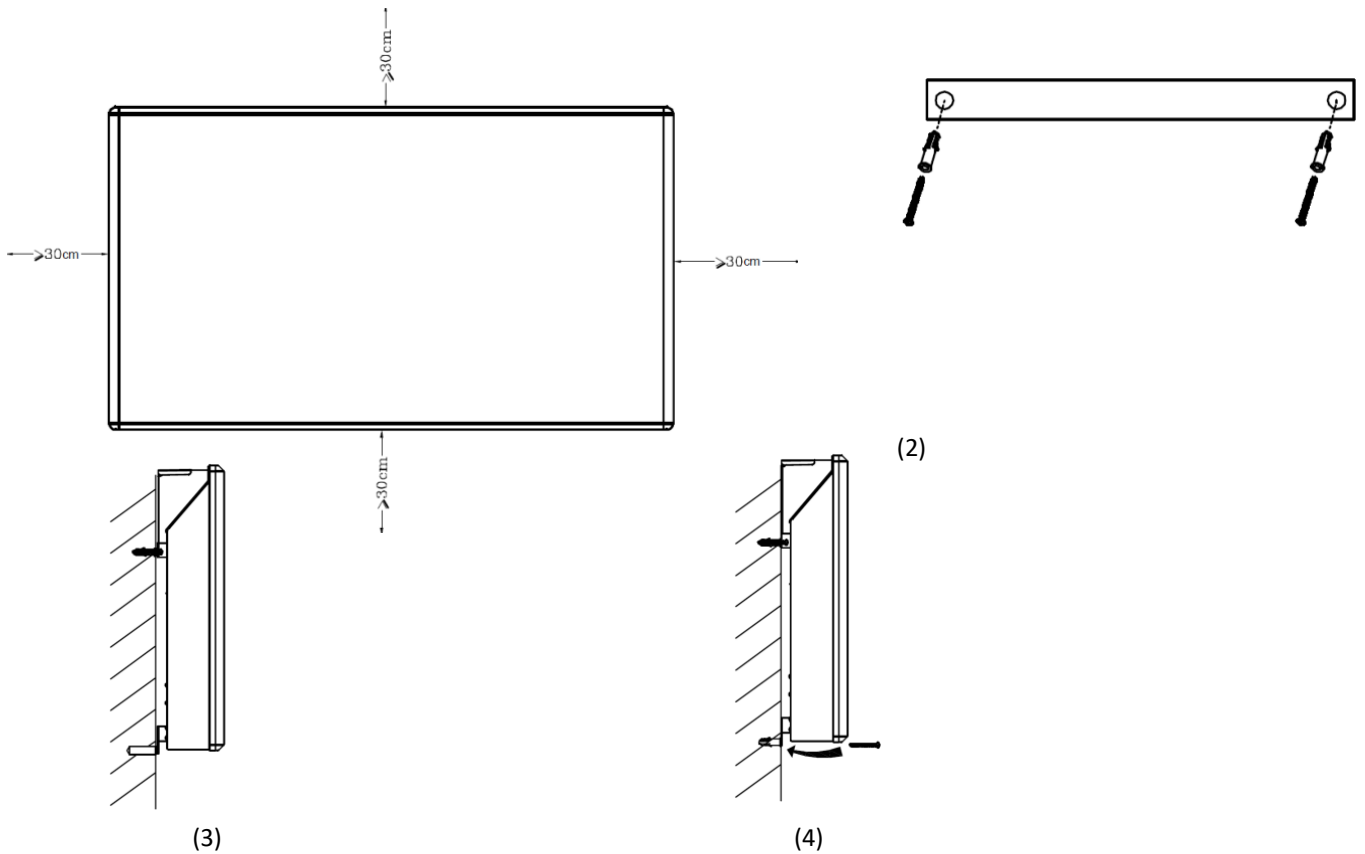

1. Be sure to keep the distance between the heater and floor, wall and so on at least 30cm as picture (1).
2. Use drill dimension paper to drill top two holes( $\Phi 8$ ) on the wall and put the expansion screws in the holes as picture (2).
3. The hook racks are pre-assembled on the back of the heater, hang the top two hook racks on the screws as picture (3). Mark the two bottom hook racks' position on the wall and take away the heater, then drill bottom two holes( $\Phi 8$ ) on the wall and put expansion screw's plastic cover in the holes as picture (3).
4. Hang the heater on the wall and put the expansion screws in the bottom two holes as picture (4).

**WARNING! Before starting the product, make sure that it is properly fixed to the wall. If the product is not level, problems may occur.**

# Using

## • Control panel

1	Display
2	Heating indicator light
3	Timer indicator light
4	Mode indicator light
5	Increase button
6	Decrease button
7	Mode button
8	Timer button
9	On / Standby button

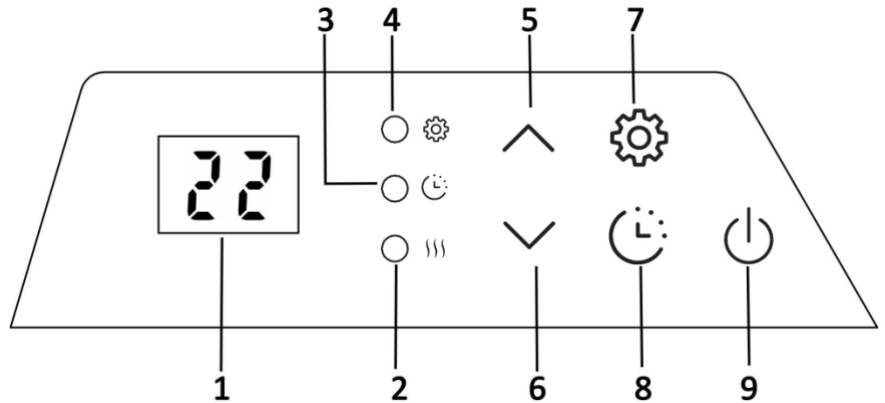

## • Start using

- Turn on the power switch, the heater enter into standby mode, and show **OF** on display.

- Press  button to turn on the heater, and the heater will enter into factory default state as the first use.











- The heating indicator light   is on if the heater is heating.

- Factory default state:





- Free mode, temperature setting 22°C
- Day: 1(Monday); Time: 00:00(hour : minute)
- Open window function: Off
- Timer: Off

## • Week and time setting

- Please note you must set week and time at the first using. Please follow below steps to set:

1. Press and hold  button 3 seconds, display show  and flash.
2. Press  or  button, display show  (Monday) and flash.
3. Press  or  button to select from 1 to 7(Monday to Sunday)
4. Press  to confirm day setting and enter time setting, display show  and flash.
5. Press  or  button to set hour.



6. Press  to confirm hour setting and enter minute setting, display show  and flash.
7. Press  or  button to set minute.
8. Press  button to confirm all settings.

**Remarks: the week and time will be reset to factory default setting if the power supply cuts off. The other settings will keep the same as last settings before power supply cutting. So, in order to keep your heater running correctly, please reset the week and time if power supply cuts off.**

## • Heating mode

- 4 modes: Free mode (Fr), Weekly program(P1), Weekly program(P2), Anti-frost mode (AF)

- Press  button to select running mode: Fr→P1→P2→AF→Fr

- **Free mode:** Temperature set 5 ~35°C by pressing  or  button.

- **Weekly program:**



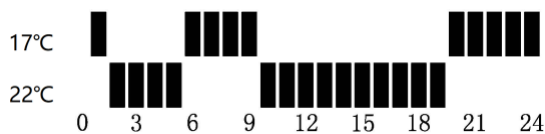









- Please note if week and time setting are not finished, when the first time enter P1/P2 mode, it is requested to set week and time first.
- **P1:** The program can't be modified. If enter P1 mode, every day will run default setting as below.



- **P2:** The program can be modified. Default setting as below.

















**Setting:**

1. In P2 mode, press and hold  button 3 seconds, display show .
2. Press  button to select from d1 to d7(Monday to Sunday).
3. Press  button to confirm day setting, display  ( °C ) flash, press  or  button to set temperature from 5°C to 35°C; Press  button again to confirm temperature setting, display  flash, press  or  button to set running hours(from 0 to 24, means 00:00 to 24:00); Press  button again to set temperature and hour until you set to 24:00; Press  button to set d2(Tuesday), and repeat the operations until all 7 days are set.

### For better understanding, please see below example:

- Tuesday
- 00:00 to 07:00, desired temperature 20°C
- 07:00 to 17:00, desired temperature 10°C
- 17:00 to 24:00, desired temperature 25°C

Setting as below:

- In P2 mode, press and hold  3 seconds → Press  and select 2 → Press  → Press   
and select 20 → Press  → Press  and select 7 (00:00 to 07:00, 20°C)
- Continue press  → Press  and select 10 → Press  → Press  and select 17 (07:00 to 17:00, 10°C)
- Continue press  → Press  and select 25 → Press  → Press  and select 24 (17:00 to 24:00, 25°C), d2(Tuesday) setting finished → Press  to set d3(Wednesday)





- **Anti-frost mode:** Maintain the temperature at 7°C. Please note no matter in which mode, if room temperature is lower than 7°C, the anti-frost mode will start running.

### • 24 hours timer

- Press  button to set timer from 0 to 24 hours.
- In any modes, if set timer, when time is up, the heater will turn off.

### • Open window function

- The heater has an open window function.
- Default setting of open window function is closed.

- In standby mode, press and hold  button for 5 seconds, display show **FO**, then press  button to set open window function on, display show **ON**, and press  button to set open window function off, display show **OF**, then press  button to save setting, or wait 15 seconds to save automatically.

- Open window function description:

1. If you open a window widely in the space where the heater is located and the temperature drop  $2\text{ }^{\circ}\text{C}$  or more than  $2\text{ }^{\circ}\text{C}$  in two minutes, a sensor will detect the sharp drop in temperature. The heater will switch out automatically and show **F0** in display.
2. The heater will come back to the previous mode after 10 minutes. However, you can manually restart the heater by pressing  button, and the heater will come back to the previous mode. The icon **F0** disappears on display.

- **Resetting the heater to factory default**

- Turn off the heater's main switch.

- Press and hold  while you turn on the heater's main switch.

## Maintenance

- ALWAYS isolate the unit from the power supply and let it cool before any maintenance.
- Clean the unit at least once a year with a vacuum cleaner to remove any dust from the heap.
- Clean the outside of the device by wiping with a damp cloth and drying with a dry cloth. Never immerse the appliance in water and never allow water to enter the unit.

## Recycling

Processing of electric and electronic equipment at the end of their service life (applicable in member countries of the European Union and other European countries operating a selective waste collection system). This symbol, affixed to the product or its packaging, indicates that the product must not be processed with household waste. It must be brought to an electric and electronic waste collection point for recycling and disposal. By ensuring the appropriate disposal of this product you also help in preventing potentially negative consequences for the environment and human health. The recycling of materials helps preserve our natural resources. For further information regarding the recycling of this product, please contact your municipality, local waste disposal centre or the store where the product



was purchased. 

Information requirements for electric local space heaters					
Model identifier(s): GPH1B , WGP1					
Item	Symbol	Value	Unit	Item	Unit
<b>Heat output</b>			<b>Type of heat input, for electric storage local space heaters only (select one)</b>		
Nominal heat output	$P_{nom}$	1,0	kW	manual heat charge control, with integrated thermostat	[no]
Minimum heat output (indicative)	$P_{min}$	1,0	kW	manual heat charge control with room and/or outdoor temperature feedback	[no]
Maximum continuous heat output	$P_{max,c}$	1,0	kW	electronic heat charge control with room and/or outdoor temperature feedback	[no]
<b>Auxiliary electricity consumption</b>			fan assisted heat output		
At nominal heat output	$el_{max}$	N.A.	kW	<b>Type of heat output/room temperature control (select one)</b>	
At minimum heat output	$el_{min}$	N.A.	kW	single stage heat output and no room temperature control	[no]
In standby mode	$el_{SB}$	N.A.	W	Two or more manual stages, no room temperature control	[no]
			with mechanic thermostat room temperature control		
			with electronic room temperature control		
			electronic room temperature control plus day timer		
			electronic room temperature control plus week timer		
			<b>Other control options (multiple selections possible)</b>		
			room temperature control, with presence detection		
			room temperature control, with open window detection		
			with distance control option		
			with adaptive start control		
			with working time limitation		
			with black bulb sensor		
Contact details	Applicant Name: IMPORTED BY FUTURA DIRECT LTD. Address: DONCASTER,ENGLAND,DN6 7AY				

Information requirements for electric local space heaters					
Model identifier(s): GPH15B, WGPH15					
Item	Symbol	Value	Unit	Item	Unit
<b>Heat output</b>			<b>Type of heat input, for electric storage local space heaters only (select one)</b>		
Nominal heat output	$P_{nom}$	1,5	kW	manual heat charge control, with integrated thermostat	[no]
Minimum heat output (indicative)	$P_{min}$	1,5	kW	manual heat charge control with room and/or outdoor temperature feedback	[no]
Maximum continuous heat output	$P_{max,c}$	1,5	kW	electronic heat charge control with room and/or outdoor temperature feedback	[no]
<b>Auxiliary electricity consumption</b>			fan assisted heat output		
At nominal heat output	$el_{max}$	N.A.	kW	<b>Type of heat output/room temperature control (select one)</b>	
At minimum heat output	$el_{min}$	N.A.	kW	single stage heat output and no room temperature control	[no]
In standby mode	$el_{SB}$	0,31	W	Two or more manual stages, no room temperature control	[no]
				with mechanic thermostat room temperature control	[no]
				with electronic room temperature control	[no]
				electronic room temperature control plus day timer	[no]
				electronic room temperature control plus week timer	[yes]
			<b>Other control options (multiple selections possible)</b>		
				room temperature control, with presence detection	[no]
				room temperature control, with open window detection	[yes]
				with distance control option	[no]
				with adaptive start control	[no]
				with working time limitation	[no]
				with black bulb sensor	[no]
Contact details	Applicant Name: IMPORTED BY FUTURA DIRECT LTD. Address: DONCASTER,ENGLAND,DN6 7AY				

Information requirements for electric local space heaters					
Model identifier(s): GPH2B, WGPH2					
Item	Symbol	Value	Unit	Item	Unit
<b>Heat output</b>			<b>Type of heat input, for electric storage local space heaters only (select one)</b>		
Nominal heat output	$P_{nom}$	2,0	kW	manual heat charge control, with integrated thermostat	[no]
Minimum heat output (indicative)	$P_{min}$	2,0	kW	manual heat charge control with room and/or outdoor temperature feedback	[no]
Maximum continuous heat output	$P_{max,c}$	2,0	kW	electronic heat charge control with room and/or outdoor temperature feedback	[no]
<b>Auxiliary electricity consumption</b>			fan assisted heat output		
At nominal heat output	$el_{max}$	N.A.	kW	<b>Type of heat output/room temperature control (select one)</b>	
At minimum heat output	$el_{min}$	N.A.	kW	single stage heat output and no room temperature control	[no]
In standby mode	$el_{SB}$	N.A.	W	Two or more manual stages, no room temperature control	[no]
			with mechanic thermostat room temperature control		
			with electronic room temperature control		
			electronic room temperature control plus day timer		
			electronic room temperature control plus week timer		
			<b>Other control options (multiple selections possible)</b>		
			room temperature control, with presence detection		
			room temperature control, with open window detection		
			with distance control option		
			with adaptive start control		
			with working time limitation		
			with black bulb sensor		
Contact details	Applicant Name: IMPORTED BY FUTURA DIRECT LTD. Address: DONCASTER,ENGLAND,DN6 7AY				