

KYOTA®

The World's Most
Advanced Massage Chairs®

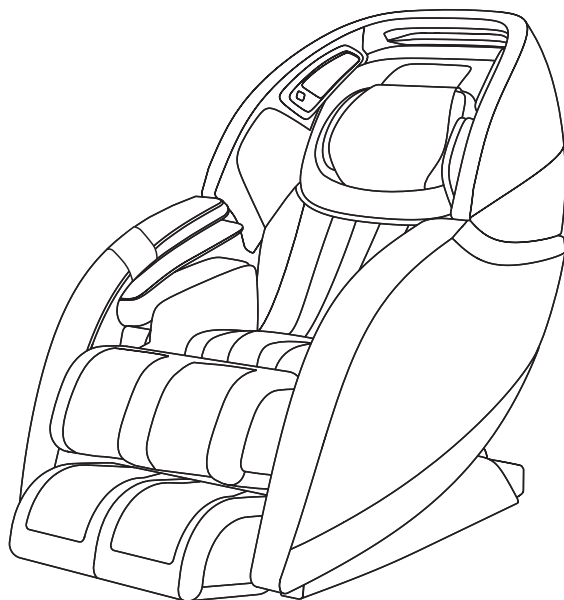

User Manual

**Kansha M878 4D
Massage Chair**

Your Chair

External Structure

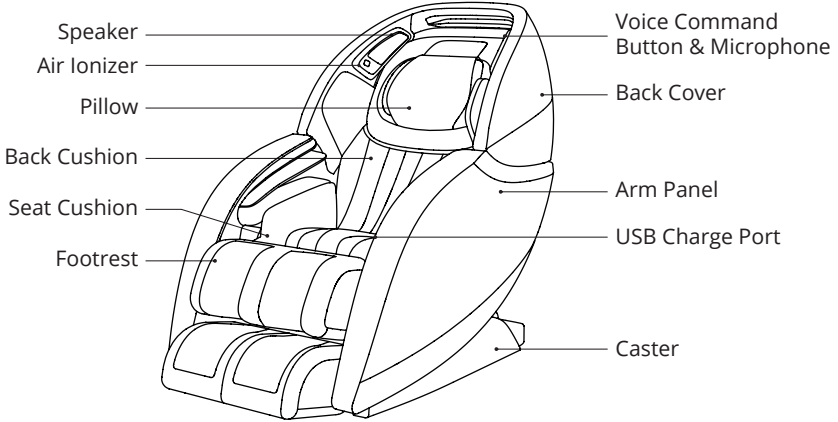

Remote Control

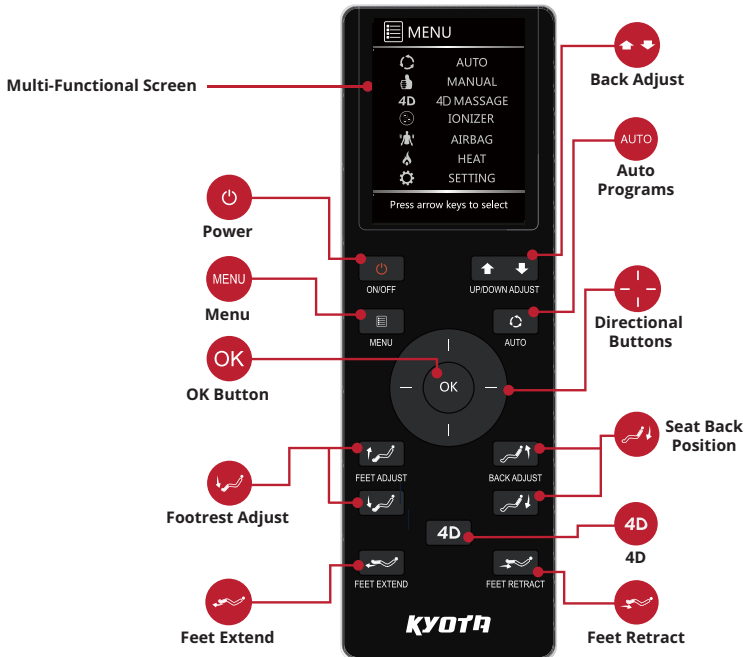

Welcome to

KYOTA®

Thank you, and congratulations on purchasing your very own Kyota Massage Chair product - you've made a great buying decision. Welcome to the Kyota family.

Please review the entire manual, including all safety information, before assembling or using your chair. If you are assembling the chair yourself, please see the Assembly Guide next and reference the online assembly video.

For convenience, we've also created a Quick Start Guide. Use it as a tool to get to know all the features of your new chair.

Sit back, relax, and enjoy your new Kyota massage chair!

Warranty Registration

Register your product at www.kyotamassagechairs.com/warranty/registration to ensure it is in our system. This will simplify the warranty process should you ever need it.

Alternatively, **scan the QR code** to go directly to the URL above.



SCAN CODE

Assembly Video

Before assembling your chair, watch an assembly video at: www.kyotamassagechairs.com/assembly-tutorials

Alternatively, **scan the QR code** to go directly to the URL above.



SCAN CODE

Chair Features

Air Ionizer

4D Massage Technology

Intelligent Voice Command + Control

Complete Calf™ Rollers and Oscillation

Automatic Footrest Extension

USB Charging Station

49" L-Track

Weightless Zero Gravity Recline

Bluetooth Technology

Zero Wall Fit™ Space-saving Technology

Total Sole Foot Reflexology Rollers

MyMassage™ Memory Programs

Lumbar Heat

Truefit™ Body Scanning

Apple/Android Application

Airbag Compression Therapy

Table of Contents

Preparation

Installation Site	6
Clearance Space for the Chair	6
Floor Protection	6
Move Methods	7
Connect to Power	7

Chair Setup

Main Power Switch	8
Adjust Pillow	8
Reduce the Intensity of your Massage - Manually	8
Truefit™ Body Scanning	9
Getting out of the Chair	9
Legrest Extend/Retract	9
Getting out of the Chair	9
Chair Entry and Exit Hazards	10
USB Charging Port	11

Getting Started

Auto Programs	12
4D Massage Programs	12
MyMassage™ Memory Programs	12
Auto Program Descriptions	13

Personalize Experience

Airbag Massage	14
Airbag Region	14
Airbag Intensity	14
Back Heat	14
Total Sole Foot Reflexology Rollers	15
Air Ionizer	15
Bluetooth Audio	15
Intelligent Voice Control + Command	16
Turn Off Listening	16
App Download & Installation	17

Settings

Timer	18
Language	18
Bluetooth	18
Voice	19
Remote Control Screen Idle	19

Create a Massage

Manual Programs	20
Massage Mode	20
Massage Part (Region)	20
Massage Width	20
Massage Speed	21
Total Sole Foot Reflexology Rollers	21
Weightless Zero Gravity Recline	21

Staying Safe

22

Fixing Issues

Troubleshooting	25
Specifications	25
Frequently Asked Questions	26

Preparation

Installation Site

Clearance Space for the Chair

- 4" clearance for the recline of the backrest; 24" clearance for the extension of footrest and sliding forward of the chair.
- Keep it 3 feet away from the TV, radio or other audio & video appliance to avoid signal interference.

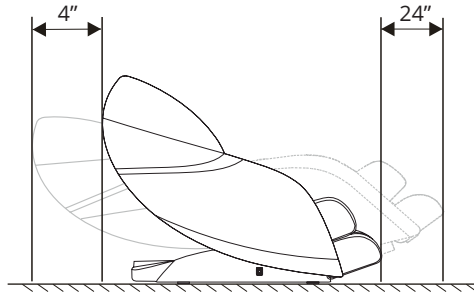

- Keep the distance between the power socket and power switch within 60" to avoid damage of power cord while massage chair sliding forward.
- Straighten the power cord while in use to avoid tangle or damage.



- To avoid serious injury or death, before sliding chair forward or backward check to make sure area is clear of children, pets, or obstacles.

Floor Protection

We recommend to place a piece of thin carpet or soft mat underneath it to avoid damaging the floor.

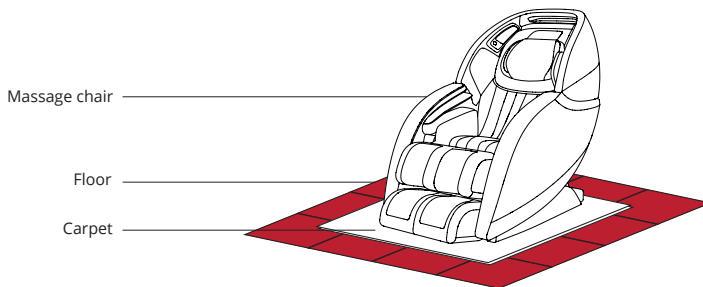

- Do not use the massage chair in high moisture environment such as near a swimming pool or bathroom to prevent electric shock accident.
- Please keep the massage chair away from heated surfaces to prevent fire hazard or damage to the product.

Move Methods

Apply pressure to the back of the massage chair from behind to pivot on the Castors. Have a second person up front to guide the Footrest until in the correct position. Maintain clearances as mentioned above. Gently lower into place. Do not pull on the side arms.

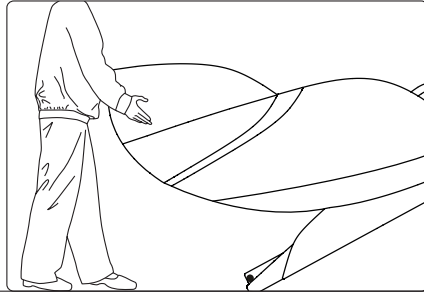

- Do not move the chair when there is user inside.

- Chair is heavy. Use caution and get assistance when lifting to avoid injury. Do NOT lift chair by footrest or armrests to avoid damage to product.

Connect to Power

Plug into a 110V grounded outlet.



WARNING

Grounding Instructions

To avoid risk of electrical shock, turn power switch off before plugging unit into electrical outlet. Use only with properly grounded outlet (3 prong). Do not plug into ungrounded outlet.

WARNING – Improper connection of the equipment-grounding conductor can result in a risk of electric shock. Check with a qualified electrician or serviceman if you are in doubt as to whether the product is properly grounded. Do not modify the plug provided with the product – if it will not fit the outlet, have a proper outlet installed by a qualified electrician.

This product is for use on a nominal 120-V circuit and has a grounding plug that looks like the plug illustrated. Make sure that the product is connected to an outlet having the same configuration as the plug. No adapter should be used with this product.

Earthing

This massage chair is a Class 1 electrical appliance. Make sure to use a grounded outlet to the grounded power supply circuit and a properly installed earth grounding rod with ground connection, to avoid electric shock.

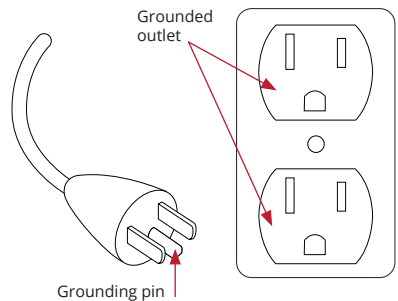

Chair Setup

Getting Comfortable

Main Power Switch

To power up the chair, flick the main power switch located on the side of the base of the chair to **ON**. Make sure the Power cord is plugged into the power cord port.

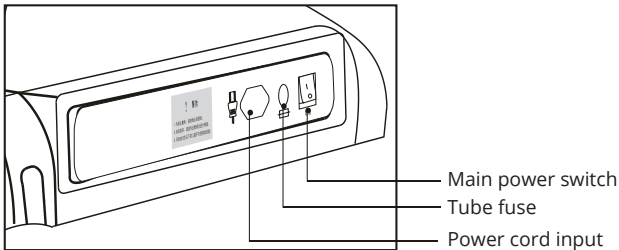

- To avoid possible damage to product or injury to unsupervised children, always turn off power switch and unplug massage chair from electrical outlet immediately after use.
- When not in use for a long period of time, we recommend that the chair be covered, the power cord be coiled and that the unit be placed in an environment free of dust and moisture.

Adjust Pillow

Take a seat in the chair and take note of where the neck pillow rests on your neck. Adjust the pillow so that it rests comfortably in the arch of your neck. Do this by removing it from the velcro, aligning it, and then reattaching to the velcro once it is in the desired position.

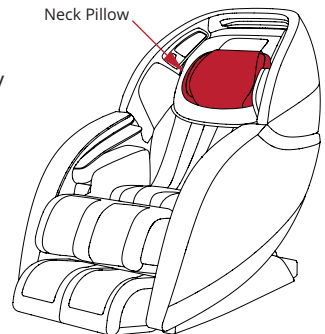

Reduce the Intensity of your Massage - Manually

To make the massage less intense, you can **add the back pad** to the seat back of your chair, or you can also **fold down the neck rest** to provide more cushioning between you and the massage mechanism in the seat back. To make the foot rollers less intense, insert the foot pads that came with your chair into the foot bed of the footrest.

TrueFit™ Body Scanning

Select any auto program and press the **OK** button. The chair will automatically begin scanning your body, mapping your back, shoulders, and neck. During this process it is important to remain seated back into the chair without lifting your head.

The scan can be viewed on the remote control screen. If fine tuning is needed just after your body scan, wait for the **shoulder adjust prompt** to appear and then use the **Back Adjustment** buttons to move the massage rollers up or down for the perfect shoulder kneading position.

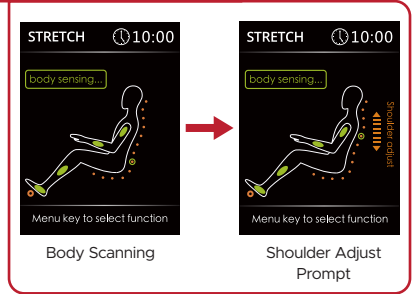

Legrest Extend/Retract

Your chair will automatically set the leg length, however, if you need to adjust, the legrest can be extended or retracted manually. To adjust the legrest, press the **feet extend** or **feet retract** button.

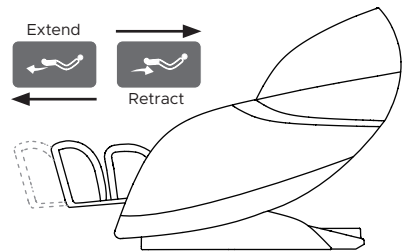

Getting out of the Chair

To easily exit the chair at any time, press the **ON/OFF** power button on the remote control to restore the chair to the upright position.

WARNING! Check to make sure children and pets are clear of chair **before** pressing on/off button to return chair to upright position. See next page for detailed hazard warnings.



Chair Setup

Chair Entry and Exit Hazards

WARNING! The areas under the footrest and behind the back rest are potentially dangerous for a child or pet. The chair back is heavy and reclines with force. A small child or pet located behind the chair could be crushed as chair is reclined resulting in serious injury or death. When chair is reclined, small children or pets who have crawled under the leg rest may not be visible to the user and could be crushed when leg rest is lowered or when chair is returned to upright position. **To avoid serious injury or death, check these areas carefully before reclining, lowering leg rest, or returning chair to upright position.**

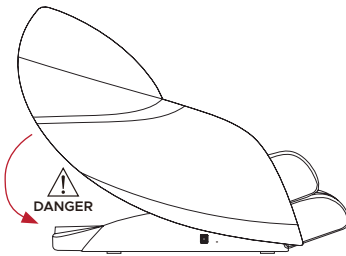

Make sure to check for children or pets **between the chair back and the base of the chair** before entering zero gravity recline.

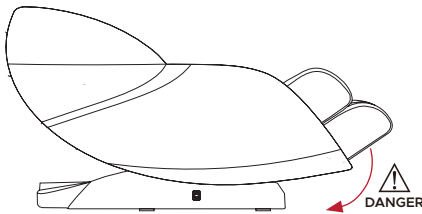

Make sure to check for children or pets **underneath the footwell** before exiting zero gravity recline and returning to upright position.

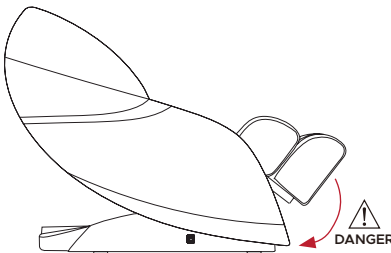

Make sure to check for children or pets **between the footrest and the chair body** before lowering the legrest.

USB Charging Port

Your massage chair includes a USB-A port to charge your phone or tablet while using the chair. This feature is especially helpful when using the app to control the chair.

The port is located on the **left hip side of the chair behind the thigh airbag**. To access, locate the thigh airbag and pull it back, away from the chair to reveal the USB port.

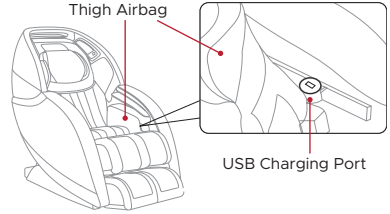

Getting Started

Auto Programs

When massage chair is operating, press the **AUTO** button on the remote control to enter Auto Program Menu. Choose from **Recover, Stretch, Back Relief, Night, Upper Body, Lower Body, MyMessage 1,** or **MyMessage 2**. Press **OK** to enter the program you desire. Selected program will show on the home screen.

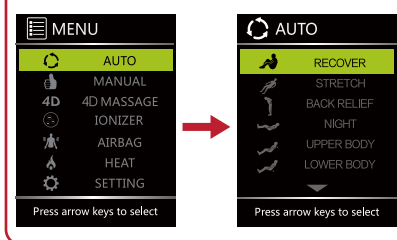

4D Massage Programs

As well as the programs in the AUTO section, there are 3 additional 4D Massage programs. To access, select **4D MASSAGE** from Home display, navigate to **MODE** and then choose from **Yoga, Deep Kneading, or Stress Relief**. Press **OK** to enter the program you desire. Selected program will show on the home screen.

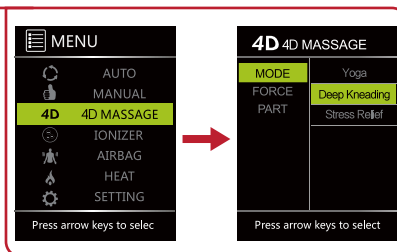

To adjust the intensity or region of your 4D Massage, press up or down button to navigate among: **FORCE** and **PART**.

MyMessage™ Memory Programs

Your chair has the ability to save your favorite customized massage programs to memory. To do this, **create a manual massage program** (see page 18 for instructions) with all of your desired air, heat, speed, and intensity settings.

Storing a memory program:

After creating your custom massage in manual mode, select **AUTO** from the Home display and scroll to the bottom of the page. Here you will see **MyMessage 1** and **MyMessage 2**. Press **OK** button to select either 1 or 2 then select **"Save"**. If you save over the top of an existing memory program, the existing program will be erased and replaced by the most recent save.

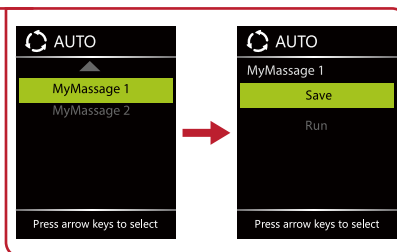

Loading a memory program

Select **AUTO** from Home display and scroll to the bottom of the page. Select **MyMessage 1** or **MyMessage 2** and then select **"Run"**. The chair will now run the program you created.

Programs	What for?	Description
Recover	Soothe muscles after sports activities and exercise.	Relaxes muscles and speeds up recovery time after intense exercise by promoting circulation.
Stretch	This program is the best choice to relax tired muscles and increase physical vigor.	Inspired by Thai massage. The strong kneading and stretching functions effectively decompress the entire body.
Back Relief	Try this program as you prepare your body to rest for the night.	Kneads the entire body with a gradual lightening of intensity massage to relieve tired muscles.
Night	This is a great program for people who work at a desk or travel a lot.	Performs a strong massage to ease muscles and recuperate the body.
Upper Body	Soothing pain and tension in the neck and shoulders.	A sequence of neck, shoulder, and upper back massage techniques.
Lower Body	Helps to relax and recover the main back muscles along your spine.	Focuses on the lumbar vertebra with targeted massage to relieve tension in this area.

4D Massage

Yoga	Reduce built up tension carried in the body from everyday stress.	Designed for morning or midday relaxing, it helps to boost the viability of muscles.
Deep Kneading	This program is recommended to relieve lower back pain.	Deep shiatsu on the back for 10 minutes.
Stress Relief	Designed for morning or midday relaxing.	Rhythmic five-minute massage to aid with deep breathing.

MyMemory

MyMassage 1	Saving custom built massage programs.	
MyMassage 2	Saving custom built massage programs.	

Personalize Experience

Airbag Massage

Select **AIRBAG** from Home display, press up or down button to navigate among: **PART** and **FORCE**. Select by pressing **OK**.

PART allows you to select which airbags to use. Select Full for all airbags. Otherwise pick and choose amongst the other Parts to turn them on or off. You may select more than one Part. To turn off all Airbags, select any lit parts and hit **OK** to turn off. When no Parts are lit, all airbags are off.

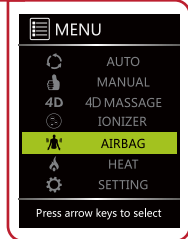

Airbag Region

Navigate to **PART**, press right button, then use the up or down button to select your desired airbag region: Full, Arm & Shoulder, Back & Waist, Leg & Foot, Buttock. Press **OK** button to select the airbag region.

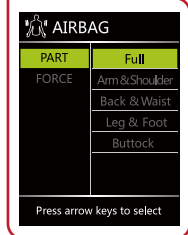

Airbag Intensity

Navigate to **FORCE**, press right button, then use the up or down button to select your desired intensity: 1 = light, 5 = firm, or Off. Press **OK** button to select the airbag intensity.

While the in-use screen is displayed during a massage program, press the **left** or **right directional button** to adjust the airbag intensity (this feature works in both Auto and Manual programs).

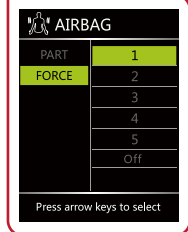

Back Heat

Select **HEAT** from Home display, press right button, then press up or down button to navigate to desired heat setting: On, or Off. Press **OK** button to select the heat setting.

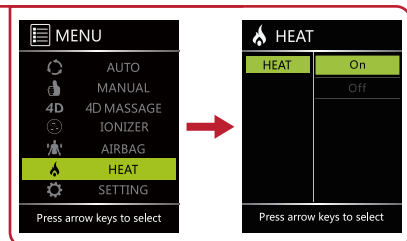

Total Sole Foot Reflexology Rollers

Select **MANUAL** from Home display, then press up or down button to navigate to **ROLLER**. Press right button, then use the up and down buttons to select your desired foot roller speed: 1 = slow, 2, 3 = fast, or Off (deactivate foot roller). Press **OK** button to select the foot roller setting.

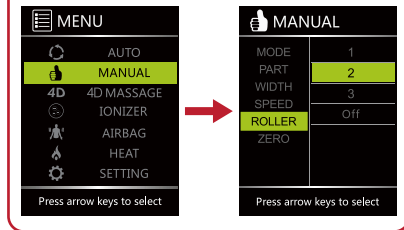

Air Ionizer

Select **AIR IONIZER** from Home display, press right button, then press up or down button to select your desired air ionizer setting: On, or Off. Press **OK** button to select the setting.

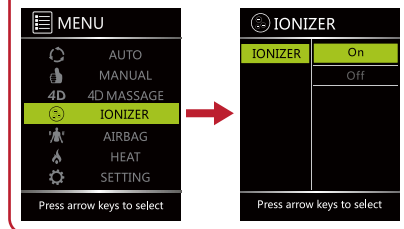

Bluetooth® Audio

Your massage chair includes Bluetooth® compatibility so you can play and enjoy your favorite music. To turn on your chair's Bluetooth®, select **SETTING** from Home display, then press up or down button to navigate to **BLUETOOTH**. Press right button, then press up or down button to select your desired Bluetooth® setting: On or Off. Press **OK** to select setting.

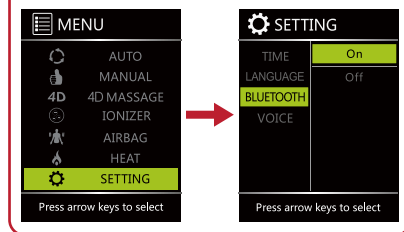

Open Bluetooth from audio device and pair with **Kansha M878** to play music.

Personalize Experience

Intelligent Voice Control

Your chair comes with built in intelligent voice control. This feature allows you to control your chair and massage experience completely hands-free by using one of the many voice commands.

To activate the intelligent voice control function, simply touch the button on the left speaker, or say **'Switch to Voice Mode'**. You may now give your chair any of the commands to the right **within 5 seconds**. Alternatively, you can touch the voice command pad on the left speaker to activate, and then speak your command within 5 seconds. Make sure to speak clearly and slowly. After 5 seconds the Intelligent Voice Command function will turn off automatically and must be awakened again.

Commands

Power On
Switch Off
Activate Massage
Recover
Stretch
Back Relief
Night
Upper Body
Lower Body
Yoga
Deep Kneading
Stress Relief
Zero Gravity
Start Heat
Heat Off

Turn Off Listening

You can turn off intelligent voice control listening by using the remote control. Select **SETTING** from Home display, press up or down button to navigate to **VOICE**, press right button, then press up or down button to select **Off**. Press **OK** button to select the setting. Intelligent voice control will now no longer activate until turned back on.

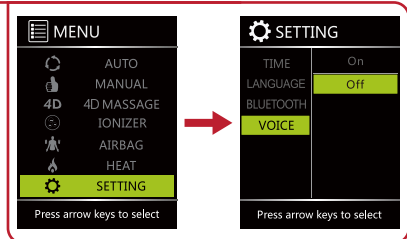

App Download & Installation

Android System Software (Android System V2.2 or later)

- Open the Google play store. In the search bar, search for '**Kyoto Massage Chair Kansha M878**'. Click on the Kansha M878 app tile.
- Click "Install" to download and install the Kansha M878 **APK**, then press Settings button on your computer or Android device > press Wireless and Web Setting > Bluetooth > Scan Bluetooth device > Kansha M878, then pair.
- Start the Kansha M878 APK, press Settings menu > Bluetooth > and pair with the Kansha M878 to link the APK

Apple iOS: (iPhone or iPad devices)

- Open the App Store. In the search bar, search for '**Kansha M878 by Kyoto**' to find the app. Click "Get" at the top right corner to download and install the software.
- In your device settings, open Bluetooth and connect it to the massage chair.

Please note: Only Apple equipment compatible with Bluetooth 4.0 can connect to the chair's Bluetooth.

Settings

Setting

Select **SETTING** from Home display, then use the up or down button to toggle between **TIME**, **LANGUAGE**, **BLUETOOTH**, or **VOICE**. Press **OK** button to enter the setting you desire to control.

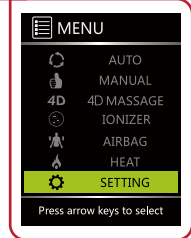

Timer

Navigate to **TIME**, press right button, then use the up or down button to select your desired timer: 10mins, 20mins, or 30 mins. Press **OK** button to select timer.

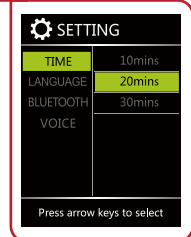

Language

Navigate to **LANGUAGE**, press right button, then use the up or down button to select your desired language: **CHINESE** or **ENGLISH**. Press **OK** button to select language.

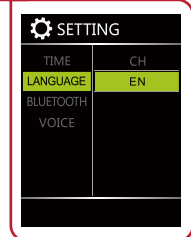

Bluetooth

To connect your Android or Apple device, press **SETTING** from Home display, then press up or down button to navigate to **BLUETOOTH**. Press right button, then press up or down button to select your desired Bluetooth setting: On or Off. Press **OK** to select Bluetooth setting.

In order to use the chair app or to play music from your Bluetooth enabled audio device, Bluetooth must first be turned on in settings. Open Bluetooth from audio device and pair with **Kansha M878** to play music.

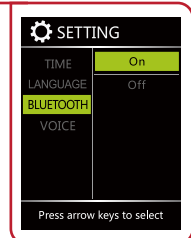

Voice

Navigate to **VOICE**, press right button, then press up or down button to select your desired voice control setting: On, or Off. Press **OK** button to select the setting.

To activate voice control function without going into settings, touch the button on the left speaker or say **"Switch to voice mode"**.



Remote Control Screen Idle

While running an Auto Program or Manual mode, the remote control screen will return to the in-use screen (as shown below) **after 10 seconds of being idle**.

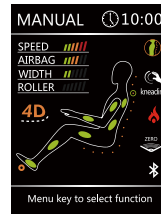

Manual
In-use screen

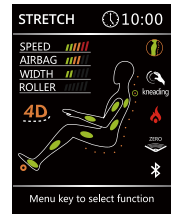

Auto Program
In-use screen



- Do not spill liquids on Remote Control and avoid placing heavy objects on Remote Control or power cord to avoid damage or malfunction.

Create a Message

Manual Programs

In Manual mode you can operate components of your massage chair individually or combine them to create unique massage scenarios.

If you create a manual massage you love, you can save it to memory and go back to it whenever you want. See **'MyMessage Memory'** on page 10 for instructions on how to do this.

Press **MANUAL** from Home display, press up or down button to navigate among: **MODE, PART, WIDTH, SPEED, ROLLER, and ZEROG.**

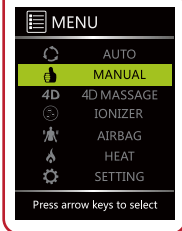

Massage Mode

Navigate to **MODE**, press right button, then use the up or down button to select your desired mode: Kneading, Tapping, Knocking, Shiatsu, or Sync. Press **OK** button to select mode.

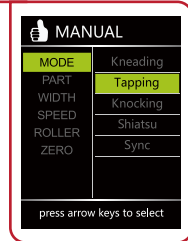

Massage Part (Region)

Navigate to **PART**, press right button, then use the up or down button to select your desired region: Whole, Partial, and Point massage. Press **OK** button to select region.

Whole travels the entire length of the track, **Partial** travels a short distance and reverses direction for focused relief, **Point** stops on the track for targeted relief. Partial and Point location can be fine tuned using the arrow up or arrow down buttons.

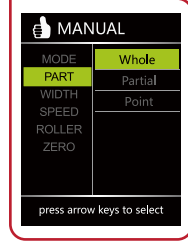

Massage Width

Navigate to **WIDTH**, press right button, then use the up or down button to select your desired width: Wide, Medium, and Narrow roller width. Press **OK** button to select mode. (Massage Width can't be adjusted when in Kneading, or Sync Manual modes).

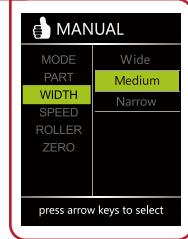

Massage Speed

Navigate to **SPEED**, press right button, then use the up or down button to select your desired speed: 1 = slow, 6 = fast. Press **OK** button to select the speed. (Massage Speed can't be adjusted when in Shiatsu).

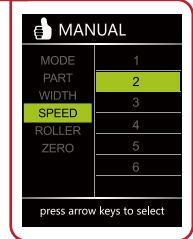

Total Sole Foot Reflexology Rollers

Navigate to **ROLLER**, press right button, then use the up or down button to select your desired foot roller speed: 1 = slow, 2, 3 = fast, or Off (deactivate foot roller). Press **OK** button to select the setting.

Your current foot roller speed is displayed in the in-use screen in the top left corner.

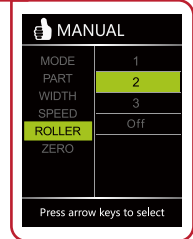

Weightless Zero Gravity Recline

Navigate to **ZERO**, press right button, then use the up or down button to select your desired zero gravity setting: On, or Off. Press **OK** button to select the setting.

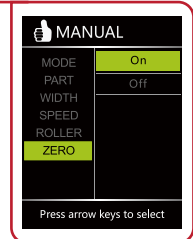

Staying Safe

Safety Information

To ensure safe use of the massage chair and avoid injury or unsafe conditions, please read and follow all instructions before using product.

WARNING

USE NOT RECOMMENDED FOR CERTAIN PERSONS

Use of massage chair may not be safe or suitable for persons with certain medical conditions and could cause serious injury or death in some circumstances. If you have any of the following conditions, please consult a physician before using the massage chair:

- Use of implanted electronic medical devices (such as a cardiac pacemaker)
- Pregnancy
- Cancer, malignant tumors, or other growths
- Osteoporosis or spinal fracture
- Other fractures or musculoskeletal injuries
- Loss of or reduced sensitivity to heat
- Implanted medical fixation devices such as rods, pins, etc.
- Recent surgery or sutures
- Skin diseases or skin injury
- High fever
- Certain pulmonary or breathing conditions
- Impaired circulation

WARNING

To avoid possible death or serious injury to user or others, please read and follow these instructions:

- **The areas under the footrest and behind the back rest are potentially dangerous for a child or pet. The chair back is heavy and reclines with force. A small child or pet located behind the chair could be crushed as chair is reclined resulting in serious injury or death. When chair is reclined, small children or pets who have crawled under the leg rest may not be visible to the user and could be crushed when leg rest is lowered or when chair is returned to upright position. To avoid serious injury or death, check these areas carefully before reclining, lowering leg rest, or returning chair to upright position.**
 - **Chair should not be used by children under age 14.** Small children could be trapped or injured by airbags, heating mechanism, or moving parts. When chair is not in use, unplug unit and secure chair so that children cannot accidentally power on and operate chair.
- Children over age 14, persons with reduced physical, sensory, or mental capabilities, and elderly or frail persons should exercise caution and use massage chair only when supervised or assisted by a person over 16 years of age.
- Chair has a heated surface and could cause burns, particularly in persons with reduced sensitivity to heat. Such persons should use the chair only after consulting with a physician and should use extreme caution during any physician-approved use.

CAUTION

To avoid the risk of minor injury or discomfort, or damage to the massage chair or other property, please read and follow these instructions for safe use of massage chair:

- Do not stand or stack heavy objects on footrest.
- Do not operate heating features of chair while under a blanket or pillow. Excessive heating can occur and cause fire, electric shock, or injury to persons.
- To avoid pinching or crushing, please do not place body parts, especially fingers and toes, between parts of chair and keep clear of moving parts.
- To avoid overheating, injury or discomfort from overuse, do not fall asleep while using massage chair and do not use for extended periods of time (longer than 20 minutes).
- Avoid use while under the influence of alcohol, medications or other substances that may cause drowsiness, disorientation, or impairment of judgment or motor skills.
- Do not use the massage chair right after a meal, as it may cause discomfort.
- If you feel any abnormal discomfort during the operation of the massage chair, turn off the power immediately and discontinue use.
- Do not use this appliance when ambient temperature is over 40 C (104 F).
- Do not use this appliance in humid or dusty environment, or when any part of the body is in contact with plumbing or any similar ground.
- Never operate the appliance with the air openings blocked. Keep the air openings free of lint, hair, dust and the like.
- Do not use outdoors.
- Do not operate where aerosol (spray) products are being used or where oxygen is being administered.
- Place the product on a flat, level floor to reduce risk of tipping or overturning.
- Do not use or store near heat or open flame.
- Intended only for users who weigh below 300 lbs.
- Use this product only for its intended use as described in this manual. Do not use attachments not recommended by the manufacturer.
- Massage chair intended only for use by one person. Do not use by two or more persons at the same time to avoid damage to the product.
- Do not allow children to stand, jump, or play on or around massage chair, even when it is not powered on or in use.
- Remove personal accessories from arms and empty pockets while using the massage features of the chair.
- Check the upholstery under the cushions and other spots for damage or loose objects that may cause injury or damage chair while operating. If any damage is present, do not use the massage chair and refer to a qualified service professional for servicing.
- To avoid damage to chair, walls, or other objects, make sure there are no obstacles behind the chair and there is enough clearance before adjusting the backrest or leg rest angle.
- Please be seated properly while using the product.

Staying Safe

- To avoid damage to chair or floors, do not drag or push the chair or roll its casters on wood floor or carpet. See instructions on p.6 for safely moving chair.
- If massage chair is not working properly, has been dropped or damaged, or has been dropped into water or exposed to flooding, return the appliance to a service center for examination and repair before attempting to use.
- Do not drop or insert any object into any openings in chair.

WARNING

Read and follow these instructions concerning safe use of the power cord and power unit to avoid possible electric shock, fire hazard, use of chair by and injury to unattended children, or damage to chair or other property.

- To avoid risk of electric shock, connect this unit to a properly grounded outlet only. See Grounding Instructions on pg. 7.
- Always unplug massage chair from the electrical outlet immediately after use and before cleaning. An appliance should never be left unattended when plugged in. To disconnect, turn all controls to the off position, then remove plug from outlet.
- Do not use massage chair and unplug from outlet during thunder or lightning storms, and before putting on or taking off parts.
- To ensure safe operation, power must be supplied only at standard 110 voltage, to the specifications of the appliance. Confirm that the power voltage stated on the rating label corresponds to your local electricity supply.
- The massage chair should be used only with the power supply unit provided. Do not use with any other power source
- Do not use a wet or damp hand to unplug the cord to avoid electric shock.
- Do not pull on the power cord to unplug. Grip by plastic end nearest outlet to unplug power cord.
- Do not squeeze, over bend, pull hard, or twist the power cord. - Keep the power cord away from heated surfaces.
- Do not carry or drag the chair by power cord or use cord as a handle.
- If there is any smoke or unusual smell while using massage chair, stop using immediately and unplug the power cord.
- Never operate the chair if it has a damaged power cord or plug. If the power cord is damaged, it must be replaced by the manufacturer or its service agent or a similarly qualified person to avoid a hazard.

Do not disassemble, dismantle or attempt to repair massage chair. Such actions, as well as misuse of product, may cause damage to or failure of massage chair and may void the manufacturer's warranty. For repairs, please contact an authorized dealer or repair agent at 603-910-5000. For additional details concerning terms, conditions and limitations of warranty, see <https://infinitymassagechairs.com/warranty-info>.

Fixing Issues

Trouble Shooting

Symptoms	Possible Causes	Possible Solution
Noise is heard while in use	These noises are normal and arise from friction between the massage rollers and the leather cover	No need to take any measures
Massage Chair does not start	The power cord is not secured into the socket	Insert the power plug properly into the power socket
	Not switched ON	Turn on the switch found on chair side. Then push power button on remote
	The fuse is blown	Replace only with a fuse of same type and rating
No music comes from the speaker	The volume is turned to the lowest setting	Adjust the speaker volume from the mobile device. Make sure Bluetooth setting on chair and phone are both ON
Backrest or footrest can not raise or recline	Excessive load has been pressed on the backrest or legrest	Replace the load and try again
Airbag malfunction	The air hose is blocked	Straighten the air hose and clear out the blockage

Specifications

Model	Kansha M878 4D
Dimension of Main Body (in)	66 x 35 x 48 (L x W X H)
Necessary Clearance to Wall (in)	4"
Net Weight (lbs)	328
Shipping Weight (lbs)	404
Max. User Weight (lbs)	300
Voltage	110-120V~
Rated Current	1.4A
Power Consumption	150W

Fixing Issues

Frequently Asked Questions

Q: I find the chair is too intense to be comfortable. What can I do?

A: Your body needs to become acclimated to therapeutic massage. To be effective, the massage techniques must compress the tissue in your body. We recommend the following steps to help get started. Then over time as your body acclimates you can increase the intensity by reducing the layers between you and the chair.

1. Use the Pillow and Pillow pad to reduce upper body intensity.
2. Use the back pad that came with your chair to reduce back intensity.
3. Use the foot bed pads that came with your chair.
4. Select **AIRBAG** from the Home display, scroll down to **FORCE**, select air intensity setting 1
- If a specific airbag is too intense, scroll down to **PART**, turn off Full and turn on only the airbags you want.
5. Select **MANUAL** from the Home display, select **ROLLERS**, and turn the foot rollers off.
6. Adjust the recline on the remote. More upright will be less intense. Zero Gravity will be more intense.

Q: I'm not a foot massage person, what should I do?

A: Turn off foot rollers: Select **MANUAL** from Home display, then press up or down button to navigate to **ROLLER**. Press right button, then use the up or down button to select **Off**. Press **OK** button to select the setting. You may also want to turn off the Leg & Foot airbags or reduce the air intensity to level 1.

Q: My chair is not performing as expected. What should I do?

A: Your Kyota massage chair is an amazing combination of programming and robotics. On occasion the chair just may need to be rebooted. To do this power down the chair and unplug from the wall for 5 minutes then plug back in and power back up to see if it self-healed. If you are still having an issue, give Kyota a call at 800-242-0761.



KYOTA[®] | **The World's Most
Advanced Massage Chairs[®]**

72 Stard Road, Seabrook, NH 03874

Toll Free #: (800) 242-0761

www.kyotamassagechairs.com

Version 1.2