

Infinity Massage Chairs  
72 Stard Road  
Seabrook, NH03874  
603-910-5000  
[www.infinitymassagechairs.com](http://www.infinitymassagechairs.com)

**INFINITY DELUXE  
MESSAGE CHAIR**

**GENESIS SE  
USER MANUAL**

Thank you for your purchase of this product. Before using, please read this USER MANUAL carefully, and pay special attention to the safety precaution to ensure proper operation and use.

Please keep this USER MANUAL properly for further reference.

## ▶ CONTENTS

SAFETY PRECAUTIONS .....	1
NAME AND FUNCTION OF EACH COMPONENT .....	3
External Structure .....	3
Internal Structure .....	3
Controller .....	4
Controller Instructions .....	5
Display Screen Menu Instructions .....	6
FUNCTIONS AND FEATURES .....	12
APP DOWNLOAD AND INSTALLATION .....	13
PREPARATION BEFORE USING .....	14
Installation Method .....	14
Position & Placement for Installation .....	18
Floor Protection .....	18
Surrounding Environment .....	18
Power Supply .....	18
Moving the Massage Chair .....	19
Turn On Power Supply .....	19
Initial Massage Chair Setup .....	20
Before Sitting in the Chair .....	20
Legrest Extend and Retract .....	21
After Using .....	21
PRODUCT STORAGE AND MAINTENANCE .....	22
TROUBLESHOOTING .....	23
TECHNICAL SPECIFICATIONS .....	24

## ▶ IMPORTANT SAFETY INSTRUCTIONS

Read all instructions before using (this appliance).

**DANGER** – To reduce the risk of electric shock:

1) Always unplug this appliance from the electrical outlet immediately after using and before cleaning.

**WARNING** – To reduce the risk of burns, fire, electric shock, or injury to persons:

1) An appliance should never be left unattended when plugged in. Unplug from outlet when not in use, and before putting on or taking off parts.

2) Do not operate under blanket or pillow. Excessive heating can occur and cause fire, electric shock, or injury to persons.

3) Close supervision is necessary when this appliance is used by, on, or near children, invalids, or disabled persons.

4) Use this appliance only for its intended use as described in this manual. Do not use attachments not recommended by the manufacturer.

5) Never operate this appliance if it has a damaged cord or plug, if it is not working properly, if it has been dropped or damaged, or dropped into water. Return the appliance to a service center for examination and repair.

6) Do not carry this appliance by supply cord or use cord as a handle.

7) Keep the cord away from heated surfaces.

8) Never operate the appliance with the air openings blocked. Keep the air openings free of lint, hair, and the like.

9) Never drop or insert any object into any opening.

10) Do not use outdoors.

11) Do not operate where aerosol (spray) products are being used or where oxygen is being administered.

12) To disconnect, turn all controls to the off position, then remove plug from outlet.

SAVE THESE INSTRUCTIONS

## ▶ TECHNICAL SPECIFICATIONS

Name: Infinity Deluxe Massage Chair

Model: Infinity Genesis SE

Rated voltage: 110-120V~

Rated frequency: 60 Hz

Rated current: 1.4A

## ▶ GROUNDING INSTRUCTIONS

This product must be grounded. If it should malfunction or breakdown, grounding provides a path of least resistance for electric current to reduce the risk of electric shock. This product is equipped with a cord having an equipment-grounding conductor and a grounding plug. The plug must be plugged into an appropriate outlet that is properly installed and grounded in accordance with all local codes and ordinances.

**DANGER** – Improper connection of the equipment-grounding conductor can result in a risk of electric shock. Check with a qualified electrician or serviceman if you are in doubt as to whether the product is properly grounded. Do not modify the plug provided with the product – if it will not fit the outlet, have a proper outlet installed by a qualified electrician.

This product is for use on a nominal 120 V circuit and has a grounding plug that looks like the plug illustrated in sketch A in following figure. Make sure that the product is connected to an outlet having the same configuration as the plug. No adapter should be used with this product.

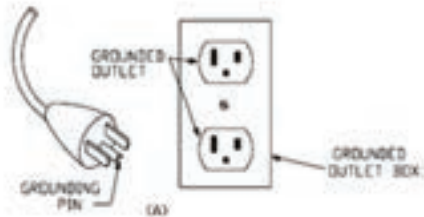

### Earthing

This massage chair belongs to Level One electrical appliance, make sure to use three-core power supply socket and to guarantee the ground wire connected to the power supply socket has obtained good ground connection to avoid electric leakage, electric shock and some other negative effect during use.

## ▶ SAFETY PRECAUTIONS

### Safety Precautions

▶ Before using, please read the SAFETY PRECAUTIONS carefully to ensure correct operation of the massage chair.



	<b>WARNING</b>	Incorrect operation may cause user injury.
	<b>CAUTION</b>	Incorrect operation may cause user injury or product damage.
		Prohibited. Specific instruction will be indicated in the diagram drawings.(e.g.: Icon on the left means do not disassemble.)
		Compulsory. Specific instruction will be indicated in the diagram drawings.(e.g.: Icon on the left means disconnect the power plug.)

### **WARNING**

	<b>COMPULSORY</b>	People with any of the following conditions should consult a doctor before using: <ol style="list-style-type: none"> <li>1. Those who are using electronic medical instrument imbedded in the body, such as a cardiac pacemaker etc.</li> <li>2. Those that are being treated by doctors for specific medical reasons</li> <li>3. Cancer patients, heart disease patients, and acute care patients</li> <li>4. Pregnant women</li> <li>5. Those with osteoporosis, spinal injuries, or back problems</li> <li>6. Those with skin disease or skin injuries</li> </ol>
		<b>PROHIBITED</b>
<b>NO DISASSEMBLY</b>		No one except maintenance personnel specified by our company should disassemble, maintain, or remodel this massage chair.

## SAFETY PRECAUTIONS

### CAUTION

 <b>COMPULSORY</b>	<ul style="list-style-type: none"> <li>◆ We advise that new users not use the massage chair for more than 20 minutes at a time.</li> <li>◆ Place the massage chair on a level surface.</li> <li>◆ When adjusting the legrest or backrest, do not use excessive force on it. Ensure children and pets are clear of the chair during use.</li> <li>◆ When unplugging the chair, hold the plug. Do not pull the power cord. Do not use a power supply that is beyond the specified electric voltage.</li> <li>◆ Before first use, uncover the back cushion to ensure the backrest and back cushion are intact. If either is damaged, stop use and contact the manufacturer for repair immediately.</li> <li>◆ Please do not operate the controller or massage chair with wet or damp hands, and do not put heavy objects on controller.</li> <li>◆ People over 260 lbs should not use this massage chair.</li> <li>◆ Please do not use other therapeutic equipment in combination with this massage chair.</li> <li>◆ During use, if you feel any pain or discomfort, stop use immediately and consult your doctor.</li> <li>◆ This massage chair is designed and intended for non-commercial household use only. Do not rely on the massage chair as medical treatment.</li> <li>◆ The massage chair is equipped with a heating function, so people with sensitivity to heat should use with caution.</li> <li>◆ Always turn off the power and remove the plug from the outlet immediately after use and before cleaning.</li> <li>◆ To avoid discomfort, do not use the massage chair immediately after meals.</li> </ul>
 <b>PROHIBITED</b>	<ul style="list-style-type: none"> <li>◆ If any surface or component of the massage chair is damaged, stop use and contact the manufacturer for assistance.</li> <li>◆ Do not fall asleep on the massage chair while it is operating.</li> <li>◆ Do not use the massage chair when you are intoxicated or ill.</li> <li>◆ If the upholstery becomes dirty, use only known good quality leather cleaner. Do not use chemical cleaners, petrol detergents, or pesticide.</li> <li>◆ Do not sit on backrest, legrest, or armrest as this could cause personal injury or damage to the massage chair.</li> <li>◆ Do not smoke while using the massage chair.</li> </ul>
 <b>REMOVE PLUG</b>	<ul style="list-style-type: none"> <li>◆ Unplug the massage chair before maintenance. Do not handle the power cord or plug with damp hands, in order to avoid electric shock.</li> <li>◆ When the massage chair is not in use, turn off the power and remove the plug from the outlet.</li> </ul>

## TROUBLESHOOTING

No.	Problem	Possible Cause	Solution
1	Sounds coming from the massage mechanism.	It is normal for sound to be made by the motors, or the massage rollers rubbing on the backrest area.	This is normal and there is no need for treatment.
2	The chair will not start or turn on.	The power cord is not plugged in.	Plug the power cord into the outlet again.
		The power switch is not turned on.	Turn on the switch
		The fuse blew out.	Replace with a new fuse.
3	No sound from the speakers	The volume is turned to lowest.	Turn the volume up
4	Backrest or legrest will not extend or retract.	Too much pressure is placed on backrest or legrest.	Reduce the pressure on backrest or legrest.
5	The seat or legrest airbag is not working.	Check whether there is an air tube blockage.	Clear the air tube.

If the massage chair is still operating abnormally after above measures have been taken, please contact local distributor for repair and maintenance.

**Note:** Do not dismantle the product by yourself. Infinity Massage Chairs will shoulder no responsibility to the damage of the product or the injury of people caused by improper use! Thanks for your cooperation.

## ▶ PRODUCT STORAGE AND MAINTENANCE

### Maintenance

- ▶ Dampen a soft cloth in neutral detergent and wipe down the chair's back cover, hand rest, legrest, air tube and plastic components, then dry them with a dry cotton cloth.
- ▶ Use dry cloth to wipe the controller and power supply box.
- ▶ Dampen a soft cloth in a neutral detergent to wipe the back cushion and pillow, then wipe again with a wet cloth, and finally place them in a well-ventilated place for natural drying.

### ⚠ Caution

- ▶ Make sure to unplug the power cord before maintenance.  
Do not handle the plug with wet or damp hands, in order to avoid electric shock. When cleaning the back cover, be cautious of detergent leaking into the power supply box.
- ▶ Do not iron the upholstery.

### Storage Method

- ▶ Wipe off dust and dirt from the product after use. If the product is not to be used for a long period of time, cover the product with a dust cover (self provided).

### ⚠ Caution

- ▶ Do not store the product under direct sunlight or in places of high temperature. This may cause the color of the upholstery to fade.

### Reminder

During daily use, please note if the following symptoms exist:

- ▶ Any unusual smells
- ▶ Power issues
- ▶ The power supply cord is hot.
- ▶ Other abnormal symptoms

### ⚠ Caution

- ▶ If any of the above issues occur, stop use of the massage chair to avoid breakdowns and accidents.
- ▶ Turn off the power supply switch and unplug power supply, and then contact the manufacturer or technician for repair and maintenance.
- ▶ Except all the normal operation and maintenance mentioned above, any other repair and maintenance should only be performed by our authorized dealer or service agent.

## ▶ NAME AND FUNCTION OF EACH COMPONENT

### External Structure

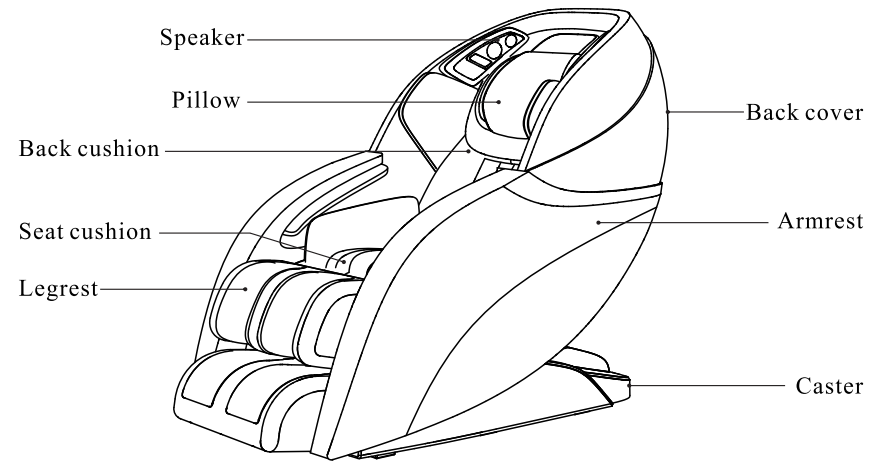

### Internal Structure

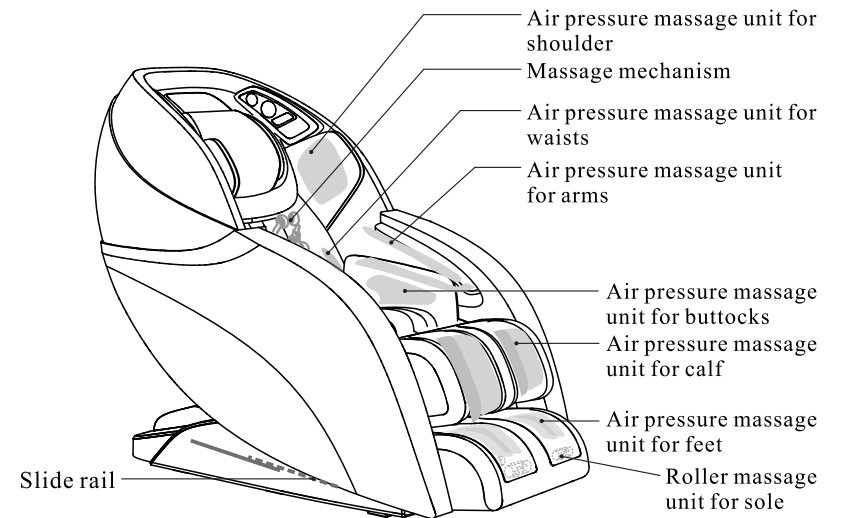

## ▶ NAME AND FUNCTION OF EACH COMPONENT

### Controller

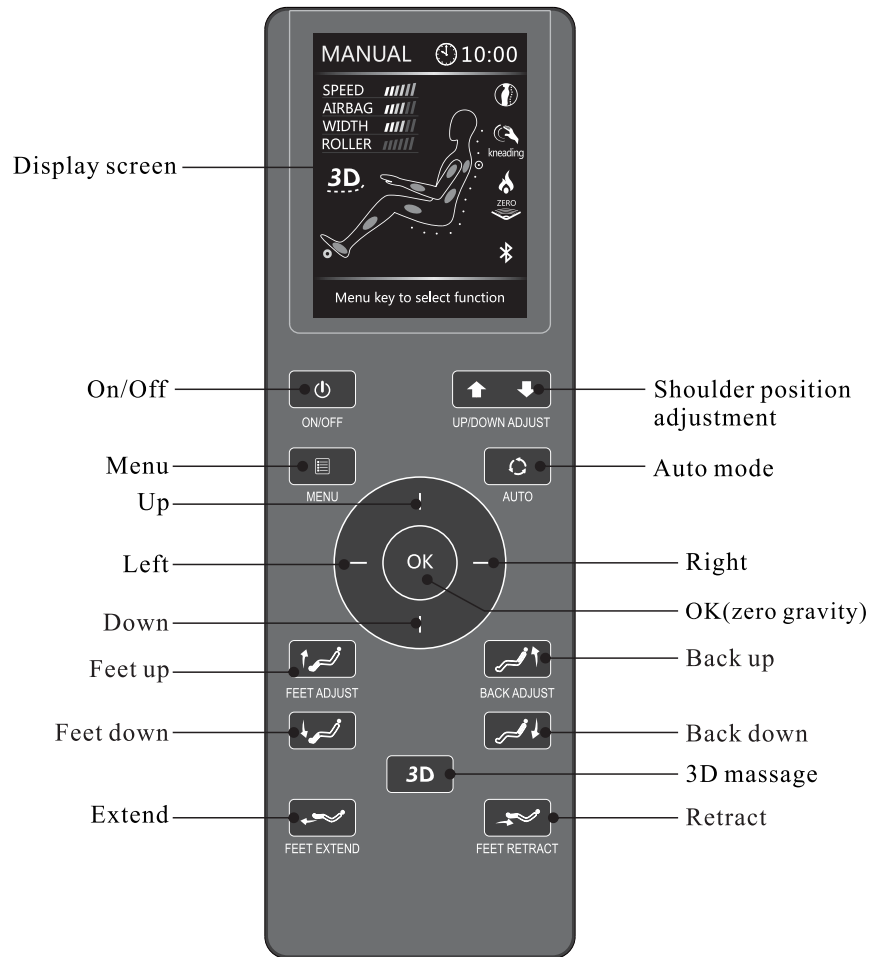

## ▶ PREPARATION BEFORE USING

### Legrest Operation

- ▶ To adjust the legrest, press  or  to extend or retract the legrest manually while it is static in order to get the best massage.

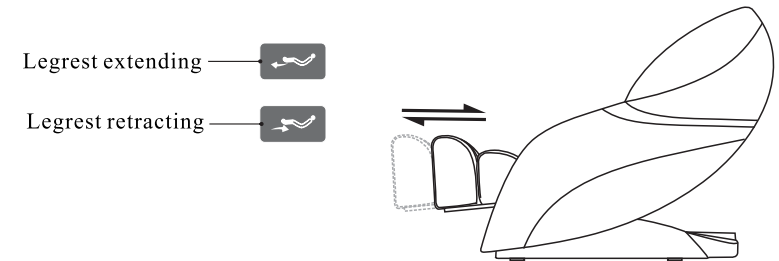

- ▶ Legrest can be extended or retracted automatically or manually according to different position and height because of the massage chair's body scan sensor.

### WARNING

- ▶ Only use the chair as intended. Sit in the chair in a normal position.
- ▶ Before adjusting the angle between calf and backrest parts, make sure there are no obstacles around.
- ▶ Do not insert leg, foot or other body parts or objects into chair's gaps while the legrest extends or resets.
- ▶ Wait for the chair to reset completely before exiting.

### After Using

- ▶ Turn off the chair and unplug the power cord from the outlet after use.
- ▶ Place the controller in the pocket.
- ▶ Turn off the chair and unplug the power cord from the outlet while it is not in use so that children cannot start the chair accidentally.
- ▶ Cover the chair if it will not be in use for a long time.

## ▶ PREPARATION BEFORE USING

### Initial Massage Chair Setup

- ▶ Before setting up the massage chair, make sure it has plenty of clearance. Then use the controller to recline the chair backrest, raise the legrest, and fully extend the massage chair.
- ▶ Test all functions to ensure they are working normally, then power off the chair and return to its original position.
- ▶ To learn more about selecting a program, please refer to Controller Instructions and Display Screen Menu Instructions.

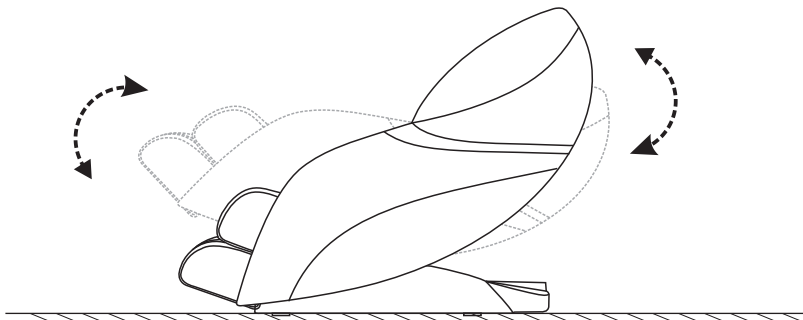

### Before Sitting in the Chair









- ▶ Make sure the legrest is installed correctly.
- ▶ Make sure the chair is in its original position. If any part is not in the initial position, power on/off again to revert the whole chair back to its original position.

#### **Caution**

- ▶ Do not try to sit in the chair if the legrest is moving.
- ▶ Do not put any heavy load on the legrest when it is moving.

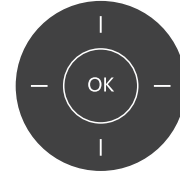
## ▶ NAME AND FUNCTION OF EACH COMPONENT

### Instruction of Controller

-  **On/Off**
  - ▶ When power is on, press this button. The display screen will light up. Click up/down button to choose Auto Mode, Manual Mode, 3D Massage, Air Pressure Massage, Heat, and Setting Menu.
  - ▶ Click this button again to turn off all functions. The default working time is 20 minutes.
-  **Menu**
  - ▶ Click this button to choose Auto Mode, Manual Mode, 3D Massage, Air Pressure Massage, Heat, and Setting Menu.
-  **Shoulder Position Adjustment** (Moves mechanism up and down)
  - ▶ Under Manual Point Mode, press the up or down buttons to set the massage on a specific area.
  - ▶ Under Auto Mode Body Sensor, press these buttons to adjust shoulder position after body scan.
-  **Auto Programs**
  - ▶ When massage chair is operating, press AUTO button to enter Auto Program Menu. Choose from Sports Refresh, Extension, Rest & Sleep, Working Relief, Neck & Shoulder or Waist & Spine (3D massage excluded). (See the LCD menu for detail.)
-  **Direction Adjustment**
  - ▶ Under Menu and Auto Mode, press this button to adjust direction. When program is selected, press the middle OK button to confirm it and enjoy the chosen massage.
  - ▶ During the massage, press OK button to switch to zero gravity. Press up or down button to adjust mechanism speed. Press left or right button to adjust airbag intensity.
-  **3D Massage**
  - ▶ Under Auto or Manual Mode, press 3D button to adjust the 3D intensity.
-  **Feet Up**
  - ▶ Press this button to extend the legrest. Release to stop.
-  **Feet Down**
  - ▶ Press this button to lower the legrest. Release to stop.

## ▶ NAME AND FUNCTION OF EACH COMPONENT



### Back up

▶ Press this button to raise the backrest. Release button to stop.



### Back down

▶ Press this button to lower the backrest. Release button to stop.



### Legrest extend

▶ Press this button to extend the legrest. Release to stop.



### Legrest retract

▶ Press this button to retract the legrest. Release button to stop.



### WARNING

▶ Press power button after use to reset. Press any remote button to stop reset. Press the power button again to continue the operation or to begin massage.

## Display Screen Menu Instructions

### ▶ Auto Mode

Once the massage chair is plugged in, press power button and the remote's LCD screen will turn on. Press AUTO to enter the Auto Program menu. Choose from Sports Refresh, Extension, Rest & Sleep, Working Relief, Neck & Shoulder, or Waist & Spine.

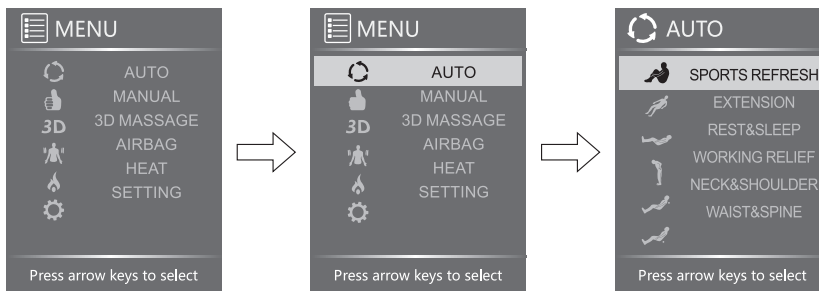

**Sports Refresh:** This is designed to soothe muscles after sports activities and exercise. It can relax muscles and speed up recovery time after intense exercise by promoting circulation.

**Extension:** This program is inspired by Thai massage. The strong kneading and stretching functions effectively decompresses the entire body. This program is the best choice to relax tired muscles and increase physical vigor.

## ▶ PREPARATION BEFORE USING

### Moving the Massage Chair

- ▶ There are moving rollers at the bottom of the chair.
- ▶ Raise the back to the highest point.
- ▶ Turn off and unplug the chair.
- ▶ Lift the front part of the chair as shown below. One person should raise the front part by holding the moving handle, while another person holds the top of the chair from behind and pushes.

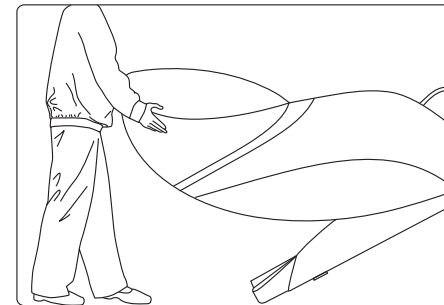

### Caution

- ▶ Do not move the massage chair while it is in use.
- ▶ Do not use the armrest to move the chair. Only hold the moving handle in the back and front.

### Turn On Power Supply

- ▶ Plug the power cord into three-prong grounded outlet.
- ▶ Turn on the chair by pressing the button at the lower part of the exterior of the right armrest.



### Caution

- ▶ Before turning on the chair, make sure there is no damage to the power cord or other exposed wires.
- ▶ Make sure the power switch is turned off before plugging in the chair.



## ▶ PREPARATION BEFORE USING

### Position & Placement for Installation

Safe placement for the massage chair:

- ▶ Ensure there is adequate space for installing the chair.
  - Back: Minimum 4 in. from the wall and any objects or obstacles.
  - Front: Minimum 24 in. from any objects or obstacles.

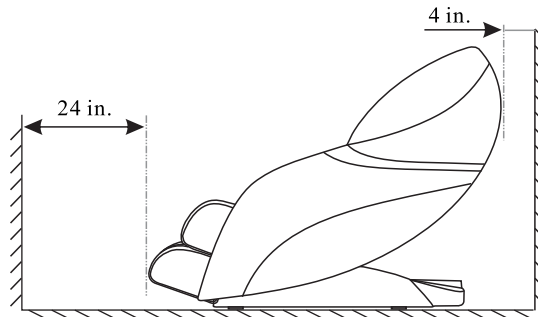

### Floor Protection

- ▶ Place the massage chair on a carpeted or other padded surface in order to avoid scratching or damaging the floor.

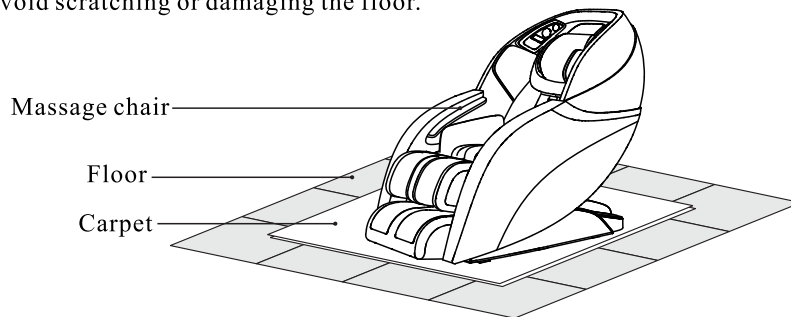

### Surrounding Environment



Keep the massage chair away from moisture and damp places (e.g.: bathroom) to avoid electrical hazards.



Keep the massage chair away from high temperature sources (e.g.: stove) to avoid fire hazards or damage to leather material.

### Power Supply

Be sure to connect the massage chair to a three-prong grounded outlet.

## ▶ NAME AND FUNCTION OF EACH COMPONENT

**Rest & Sleep:** This mild massage is great for your lunch break or before sleeping. It kneads the entire body with heavy and light intensity massage to relieve tired muscles gradually.

**Working Relief:** This is a great program for people who work at a desk or travel a lot. It performs a strong massage to ease muscles and recuperate the body.

**Neck & Shoulder:** This program relieves neck and shoulder pain, as 80% of the massage time focuses on the neck and shoulders. The curved design of the chair backrest allows the massage rollers to completely touch the shoulder and neck. This function effectively relieves fatigue in these areas.

**Waist & Spine:** To relieve the pain of the lower back, 80% of this massage focuses on the lumbar vertebra and the rollers will conduct targeted massage to relieve tension in this area.

### ▶ Manual Programs:

Press Menu button, choose Manual, and press OK to enter Manual Programs. Press up or down button to choose mode, part, width, speed, roller or zero gravity.

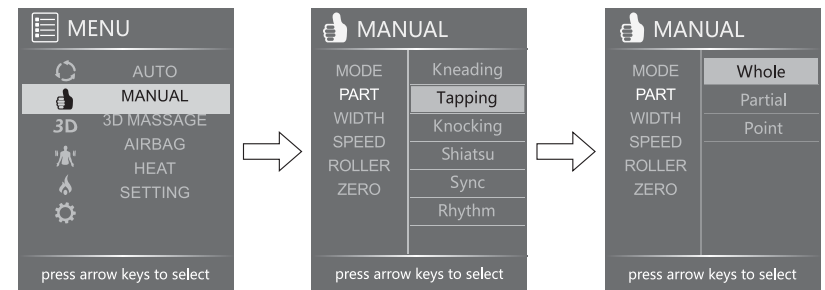

**Mode:** Under Mode function, press right button, then press up or down button to select massage style. Choose from kneading, tapping, knocking, shiatsu, sync, or rhythm.

**Part:** Under Part function, press right button first, then press up or down button to select whole, partial or point.

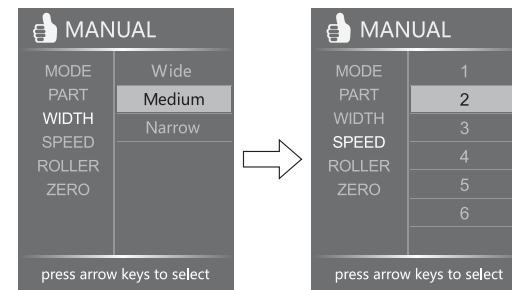

**WIDTH:** Under Width function, press right button, then press up or down button to choose Wide, Medium or Narrow.

**SPEED:** Under Speed function, press right button, then press up or down button to choose speed between 1 and 6.

## ▶ NAME AND FUNCTION OF EACH COMPONENT

**ROLLERS:** Press MENU button first, then choose ROLLER. Adjust the roller speed from 1 to 3, or stop the rollers by pressing up or down button.

**ZERO GRAVITY:** Zero gravity creates a completely relaxing, naturally comfortable massage position. This design places the back, buttocks, and legs in the same angle that astronauts experience in space. Zero gravity provides a sense of weightlessness and promotes circulation and a steady heart rate.

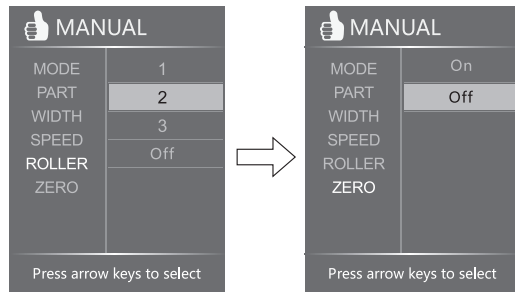

### ▶ 3D MESSAGE

Press MENU button first, then choose 3D. Adjust the 3D MODE by choosing from Deep Shiatsu, Healthy Breath, and Massage Extend. You can also adjust massage force and part.

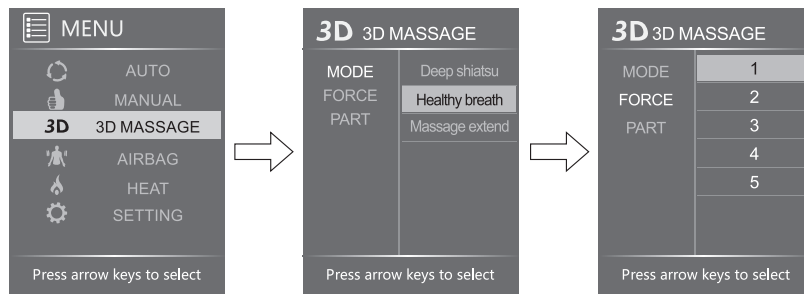

**Deep Shiatsu:** Deep shiatsu on the back for 10 minutes

**Healthy Breath:** 5 minutes of healthy breath massage with rhythm for breathing in and out

**Massage Extend:** 5 minutes of massage and extension

**FORCE:** Under FORCE function, 3D massage intensity offers levels 1 to 5.

**PART:** Under PART function, press right button, then press up or down button to choose whole, partial or point.



## ▶ PREPARATION BEFORE USING

### Step 5: Remote Control Installation

- ▶ Connect the data line of the controller to the port on the inside of right armrest (pay attention to the convex-concave between connector and port); then fix the screw cap. (See the figure below.)

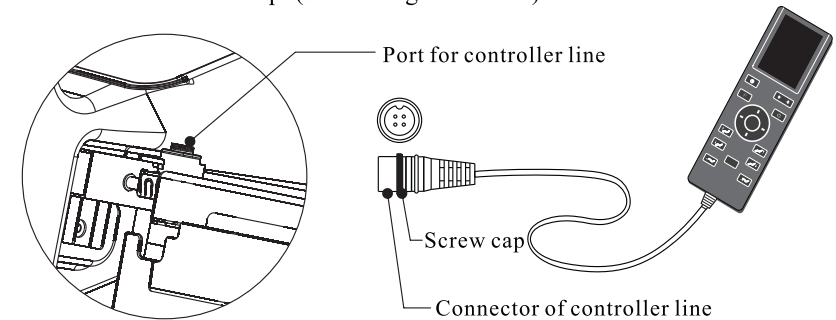

### Step 6: Other Accessories

- ▶ Connect the power wire connector to the port on the outside of right armrest.
- ▶ Turn on the chair, and use the controller to raise the backframe to normal position.

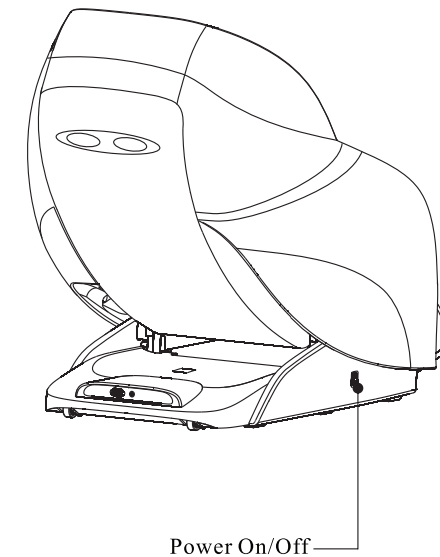

## ► PREPARATION BEFORE USING

- After the calf is connected to the axle, fasten it with the lock on the left and right side. (See the figure below)

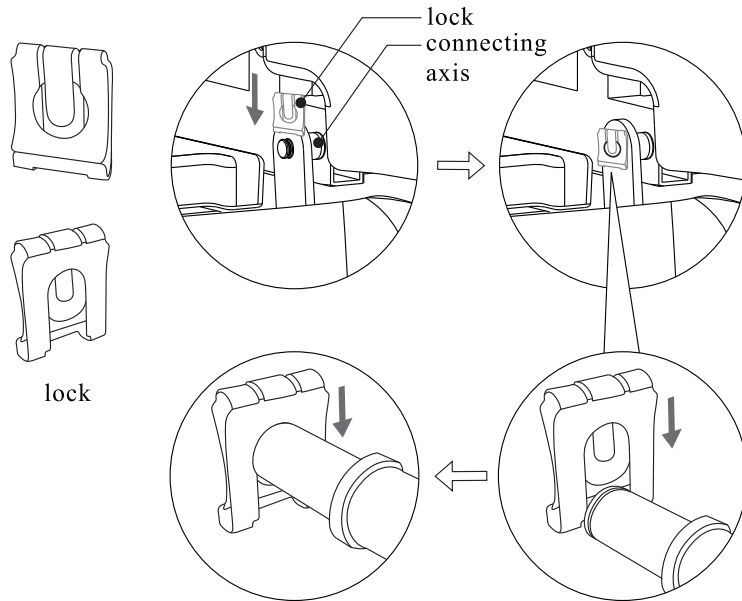

- Lift the calf massager unit, connect the airtube and air valve plug unit into the ports on the seat base, and make sure they are fastened.

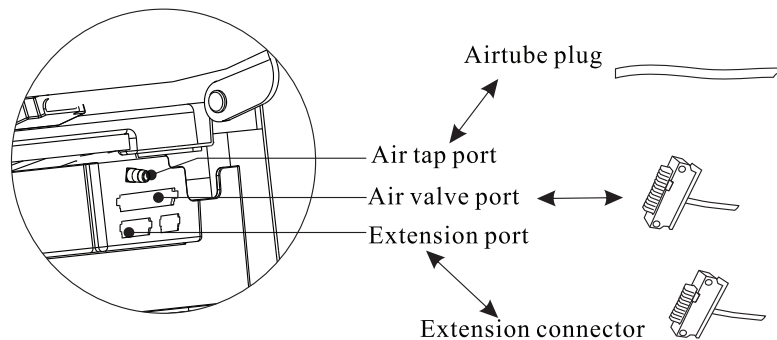

## ► NAME AND FUNCTION OF EACH COMPONENT

### ► AIRBAG

Press MENU button first, then choose AIRBAG, press up or down button to choose airbag place and force.

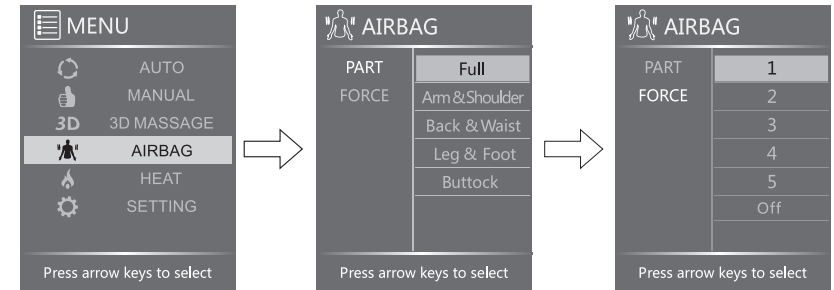

### PART:

Under AIRBAG PART function, press right button, then press up or down button to choose Full, Arm & Shoulder, Back & Waist, Leg & Foot, or Buttock.

### FORCE:

Under AIRBAG FORCE function, press right button, then press up or down button to choose airbag force from levels 1 to 5 or to stop the airbag.

### ► HEAT

Click MENU, choose HEAT, then click right to turn on or off.

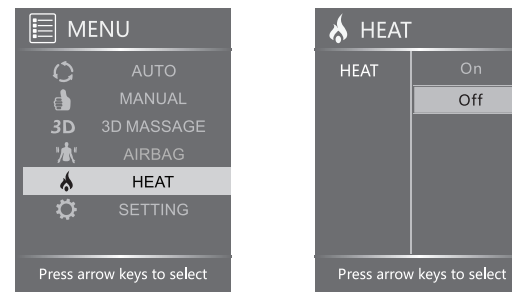

## ▶ NAME AND FUNCTION OF EACH COMPONENT

### ▶ SETTING

Press MENU button, choose SETTING, then press up or down button to set time, language, or Bluetooth.

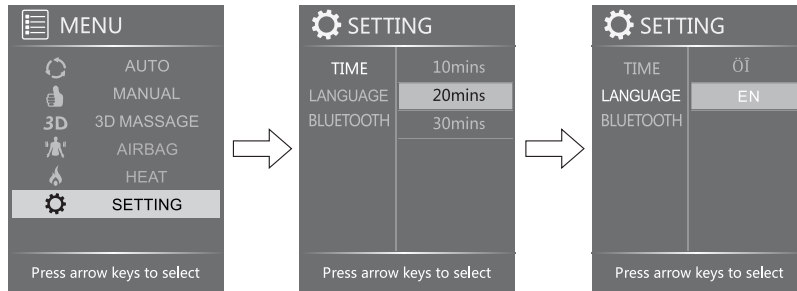

**TIME:** Under SETTING TIME function, press right button, then press up or down button to choose 10 minutes, 20 minutes or 30 minutes. The default setting is 20 minutes.

**LANGUAGE:** Under SETTING LANGUAGE function, press right button, then press up or down button to set CHINESE or ENGLISH menu.

**BLUETOOTH:** Under SETTING BLUETOOTH function, press up or down button to START or STOP Bluetooth.

**MEMO:** All the above settings are saved even when the machine is cut off suddenly.

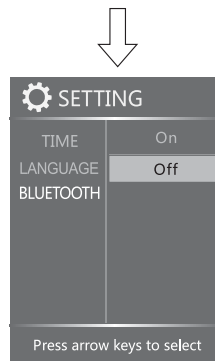

## ▶ USB CHARGING PORT

### How To Use

The Genesis SE includes a 1 amp charger. Allows you to charge your phone/tablet while using the chair. Especially great when using the App/APK to control the chair. Uses a Type A USB.

Port is located on left thigh area behind the thigh airbag.

## ▶ PREPARATION BEFORE USING

### Step 3: Legrest Installation

▶ Lift the legrest and connect the hook on the legrest to the coupling shaft on the seat frame. Repeat on the other side.

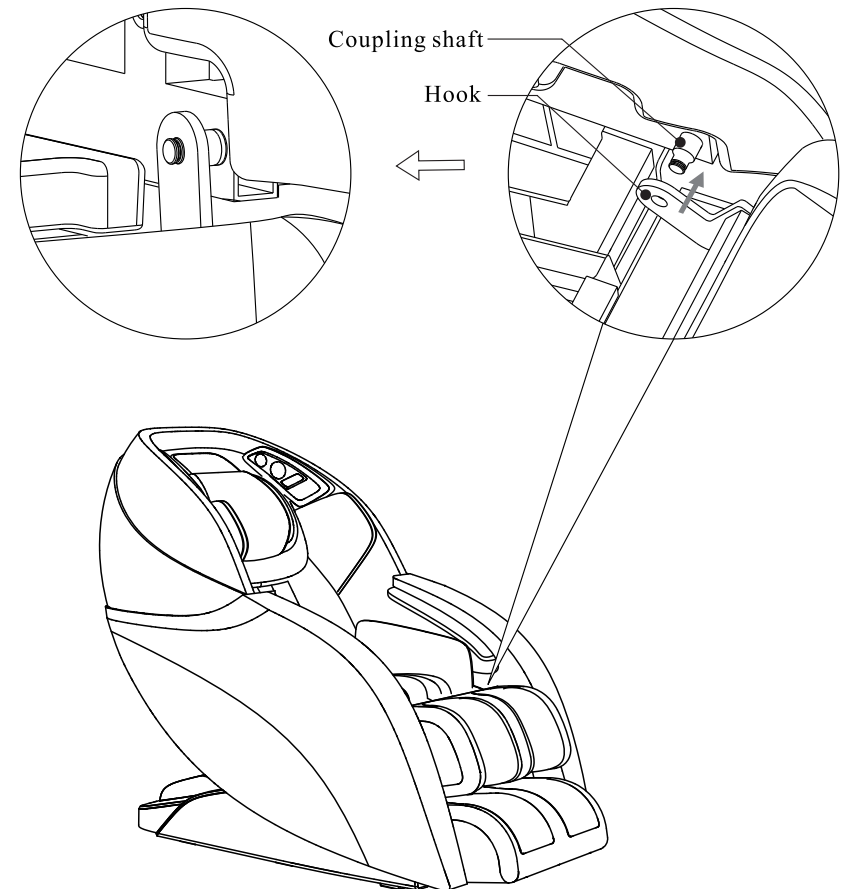

## ► PREPARATION BEFORE USING

### Installation Method

#### Step 1: Unpack the massage chair

- Unpack the cartons, carefully taking out pads and cushions, accessories box, and unit pieces.
- Check all accessories with packing list.

#### Step 2: Installation of Armrest Units

- First, connect the seat's air tube plug to the armrest's air tap port.
- Hang the hook of the armrest unit to the connecting rod of the backrest, and then connect the armrest to the side of seat frame. Push the armrest down to secure it in place.
- Fasten the armrest to the seat frame with one screw. Repeat steps above for opposite armrest.

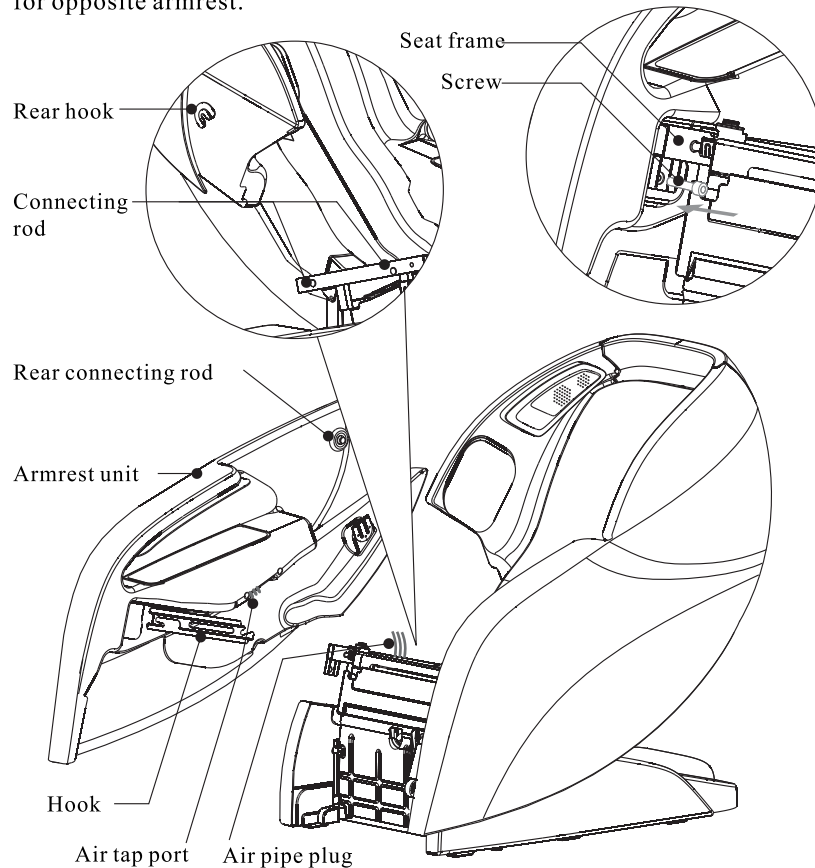

## ► NAME AND FUNCTION OF EACH COMPONENT

### Note:

1. Under both Auto Mode and Manual Mode, the remote will return to home page as shown below if it remains idle for 10 seconds.

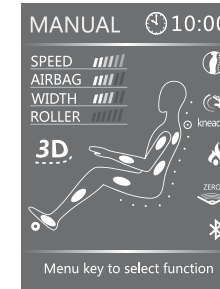

Home page in Manual Mode

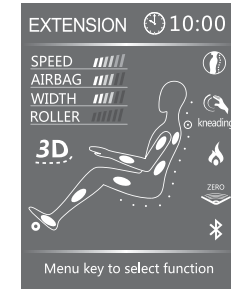

Home page in Auto Mode

### ⚠ Caution

- During use, press MENU twice to return to the home page immediately.
- On the home page, under either Manual Mode or Auto Mode, press the left and right button to adjust air pressure intensity. Under Manual Mode, press up and down to adjust massage roller speed.
- Press AUTO to choose Auto Program directly.

### ⚠ Caution

- Please do not disassemble the massage chair for any reason.
- Please do not spill water or other liquids on the controller in order to avoid key malfunctions and error codes.
- Please do not place heavy objects on the controller or power cord.

## FUNCTIONS AND FEATURES

### 1: SPACE-SAVING FUNCTION

The Genesis SE massage chair has the ability to move forward before performing a massage. This allows it to be placed closer to the wall than a standard massage chair. Keep this in mind when positioning the chair.

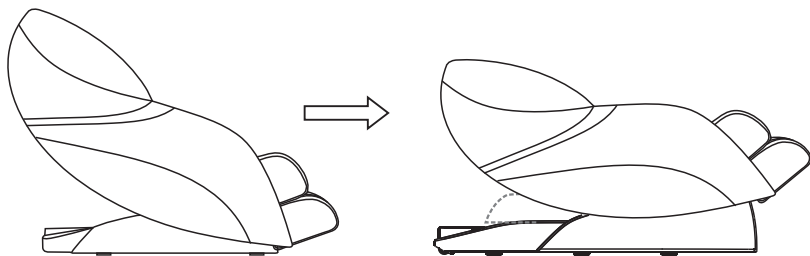

### 2: ZERO GRAVITY

Zero gravity creates a completely relaxing, naturally comfortable massage position. This design places the back, buttocks, and legs in the same angle that astronauts experience in space. Zero gravity provides a sense of weightlessness and promotes circulation and a steady heart rate.

### 3: 3D MESSAGE MECHANISM

New design of 3D mechanism and movement allow all users to adjust their massage intensity.

### 4: AUTO/MANUAL LEGREST EXTENSION

Legrest can extend 3 in. to accommodate different heights in both Auto and Manual Modes.

### 5: AIRBAG MASSAGE

Airbags are located throughout the chair in order to massage the arm, back, waist, shoulder, buttocks, leg and feet.

### 6: FOOT MESSAGE ROLLERS

Three massage rollers in each foot unit conduct an all-around shiatsu massage on the sole.

### 7: DIVERSIFIED MESSAGE TECHNIQUES

Massage techniques include: knocking, kneading, tapping, kneading/knocking combination, shiatsu, and kneading on the leg, which imitates a professional massage therapist.

### 8: BLUETOOTH AUDIO

The massage chair includes Bluetooth compatibility. Easily play music by connecting your Android or Apple device.

### 9: L-SHAPED MESSAGE TRACK

## APP DOWNLOAD AND INSTALLATION

### Bluetooth Connection Method

Installation and connection are different for Apple iOS vs. Android, please see the details below:

#### Apple iOS: (iPhone or iPad devices)

1. Open the App Store . At the top right corner, search for keywords like “Infinity massage chair, GENESIS SE, or massage chair” to find the Apple app. Click “GET” at the top right corner to download and install the software.
2. In your device Settings, open Bluetooth and connect it to the massage chair. Please note: Only Apple equipment compatible with Bluetooth 4.0 can connect to the chair's Bluetooth.

#### Bluetooth-enabled Audio Devices

- ▶ This product has Bluetooth compatibility to connect with audio devices. Open Bluetooth from audio devices and pair with GENESIS SE to play music.

### Android System Software

- ▶ Please contact Infinity Massage Chairs for Android software, then install on your computer or mobile device.
- ▶ Install GENESIS SE APK, then press Settings button on your computer or Android device > press Wireless and Web Settings > Bluetooth > Scan Bluetooth device > GENESIS SE, then pair.
- ▶ Start the APK, press Settings menu > Bluetooth > and pair with the GENESIS SE to link to the APK.

### Caution

- ▶ When connecting your Bluetooth-enabled device, please make sure the chair is turned on, otherwise it will not find the chair.

### Equipment Requirements

- ▶ Smart PC or mobile devices with Bluetooth capability
- ▶ Android System V2.2 or later