

CAUTION

IMPORTANT SAFETY INSTRUCTIONS

Read all instructions before using this massage chair.

DANGER - To reduce the risk of electric shock, injury or damage please follow the instructions below.:

1) Always unplug the massage chair from the electrical outlet immediately after using and before cleaning.

WARNING- To reduce the risk of burns, fire, electric shock, or injury to the user:

1) Never operate the chair unattended. If not in use please unplug the power cord from the outlet.

2) Do not use this chair with any blankets or loose material. Excessive heating can occur and cause fire, electric shock, or injury to persons.

3) Close supervision is necessary if there are children or pets near the massage chair. It is advised that there is at least a 10 feet distance from children and pets.

4) Use this massage chair only for its intended use as described in this manual.

Do not use attachments not recommended by the manufacturer.

5) Never operate this massage chair if it has a damaged cord or plug, if it is not working properly, if it has been dropped or damaged, or has significant contact with liquids. Contact your service center for examination and repair.

6) Do not grab the chair by the power cord or any other cable when moving the massage chair.

7) Keep the cord away from heated surfaces.

8) Never operate the massage chair with the air vents blocked. Keep the air openings/vents free of lint, hair, and other obstructions.

9) Never drop or insert any object into any opening.

10) Do not use outdoors.

11) Do not operate where aerosol (spray) products are being used or where oxygen is being administered.

12) To disconnect, turn all controls to the off position, then unplug from the outlet.

13) Do not use massager in close proximity to loose clothing or jewelry.

14) Keep long hair away from massager while in use.

15) Use heated surfaces carefully. May cause serious burns. Do not use over insentive skin areas or in the presence of poor circulation. The unattended use of heat by children or incapacitated persons may be dangerous.

SAVE THESE INSTRUCTIONS

For use household only

Osaki

OS-4D Pro Ekon+

INSTRUCTION MANUAL

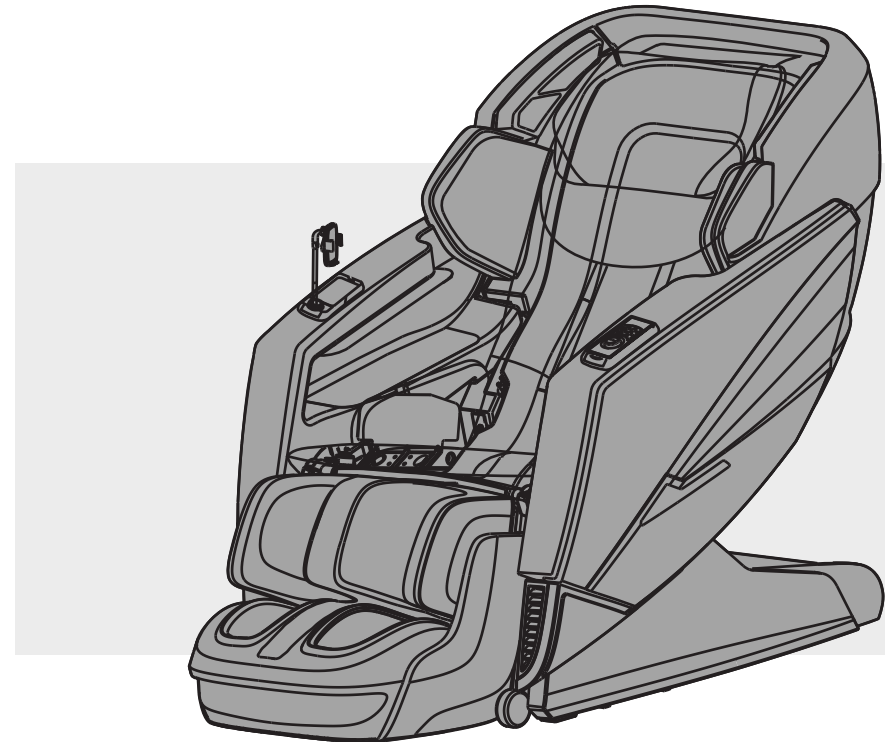

Please read all instructions carefully before using.

Thank you for purchasing this product.
Please read this user manual carefully before using to ensure proper operation.
Please keep this USER MANUAL properly for future reference.

CONTENTS





SAFETY PRECAUTIONS	1
NAME AND FUNCTION OF EACH COMPONENT.....	3
External Structure	3
Internal Structure	3
Controller	4
Instructions of Controller.....	5
Display Screen Instructions	6
Armrest Control Panel	12
Instructions of Armrest Control Panel.....	12
FUNCTIONS AND FEATURES.....	14
Mobile Phone Holder.....	15
PREPARATION BEFORE USING.....	16
Installation Site.....	16
Floor Protection.....	17
Surrounding Environment.....	17
Grounding.....	17
Installation Methods	18
Moving the Massage Chair.....	22
Connecting to Power.....	22
Commissioning.....	23
Before Sitting in the Chair.....	23
Footrest Extends/Retracts.....	24
Audio Function.....	24
After Use	24
APP DOWNLOAD AND INSTALLATION	25
Android/Apple iOS System.....	25
Prerequisites	25
CARE AND MAINTENANCE	26
TROUBLE SHOOTING	27
PRODUCT SPECIFICATIONS	28

▶ PRODUCT SPECIFICATIONS

Product name: Deluxe Multi-function Massage Chair
 Model number: OS-4D Pro Ekon+
 Rated voltage: 110-120V~
 Rated frequency: 60Hz
 Rated current: 1.6A

▶ SAFETY PRECAUTIONS

- ▶ Precautions listed below will help to ensure proper use of this appliance.
- ▶ The hazard that may cause by incorrect use are classified into “WARNING” and “CAUTION”, please ensure that you read all instructions before using the massage chair.

 WARNING	Improper operation may cause severe personal injury or substantial property damage.		
 CAUTION	Improper operation may cause personal injury or product damage.		
	Prohibited		Do not Disassemble

Not Suitable For Below Persons

We recommend that those with any of the following conditions should consult your physician before using.

 WARNING	<ul style="list-style-type: none"> ◆ Those who are using electronic medical instrument embedded in the body, such as cardiac pacemaker. ◆ Those undergoing treatment, especially those who are not feeling well. ◆ Those with malignant tumors or malignant abscesses.(Need to be supervised) ◆ Those with osteoporosis or fracture spine. ◆ Those with skin disease or those whose skins are injured. ◆ Those with high fever. ◆ Close supervision is necessary when this product is used by, on, or near children, invalids, or disabled persons ◆ The appliance has a heated surface. Persons insensitive to heat must be careful when using the appliance. ◆ This appliance can be used by children aged from 8 years and above and persons with reduced physical, sensory or mental capabilities or lack of experience and knowledge if they have been given supervision or instruction concerning use of the appliance in a safe way and understand the hazards involved. ◆ Children shall not play with the appliance. ◆ Cleaning and user maintenance shall not be made by children without supervision.
---	---

Controller Precautions

 CAUTION	<ul style="list-style-type: none"> ◆ Do not operate the controller or pull the controller cable with damp hand. ◆ Do not spill water or other liquid onto the controller to avoid fault. ◆ Do not lay heavy objects on the controller.
---	---

Cautions Regarding the Adapters and Cord



 CAUTION	<ul style="list-style-type: none"> ◆ Always unplug this appliance from the electrical outlet immediately after using and before cleaning. ◆ An appliance should never be left unattended when plugged in. Unplug from outlet when not in use. ◆ Unplug from outlet during thunder or lightening storms, and before putting on or taking off parts. ◆ Never operate this appliance if it has a damaged cord or plug, if it is not working properly, if it has been dropped or damaged, or dropped into water. Return the appliance to a service center for examination and repair. ◆ Check that the power voltage stated on the rating label corresponds to your local electricity supply. ◆ Do not use a damp hand to unplug the cord to avoid electric shock. ◆ Do not drag the cord, reach to the front plastic end to unplug it. ◆ Do not squeeze, over bend, pull hard, twist the cord. ◆ Keep the cord away from heated surfaces. ◆ Do not carry this appliance by supply cord or use cord as a handle. ◆ To disconnect, turn all controls to the off position, then remove plug from outlet. ◆ The appliance is only to be used with the power supply unit provided with the appliance. ◆ It must only be supplied at safety extra low voltage corresponding to the marking on the appliance. ◆ If the supply cord is damaged, it must be replaced by the manufacturer or its service agent or a similarly qualified person in order to avoid a hazard.
---	---

SAFETY PRECAUTIONS

Best Circumstances

 CAUTION	<ul style="list-style-type: none"> ◆ Do not operate under blanket or pillow. Excessive heating can occur and cause fire, electric shock, or injury to persons. ◆ Do not use this appliance where temperature is over 40 C. ◆ Do not use this appliance in humid or dusty environment, or when any part of the body is in contact with plumbing or any similar ground. ◆ Never operate the appliance with the air openings blocked. Keep the air openings free of lint, hair, and the like. ◆ Do not use outdoors. ◆ Please place the product on the flat level floor. ◆ Do not store near heat or open flame. ◆ Connect this unit to a properly grounded outlet only. See Grounding Instructions.
---	---

Best Practices For Safe Use

 CAUTION	<ul style="list-style-type: none"> ◆ Only for users weighs below 120kg. ◆ Use this product only for its intended use as described in this manual. Do not use attachments not recommended by the manufacturer. ◆ Do not use the product for therapeutic treatment purpose. ◆ Appliance should only be used by one person, do not use by two or more persons at the same time to avoid damage to the products. ◆ Do not use the product right after meal, it may cause discomfort. ◆ Remove the accessories from the arms and empty the pockets while use the massage services. ◆ Check the upholstery under the cushions and other spots, if any damages are present, do not use it and refer to a qualified service professional for servicing. ◆ If you feel any abnormal discomfort during the operation of this product, turn off the power immediately and do not use the product. ◆ Use the appliance for 20 minutes each time is highly recommended ◆ Make sure there is no obstacles behind the chair and there is enough clearance before adjusting the backrest or legrest angle. ◆ Make sure no other excessive load pressed on the backrest or legrest besides the user. ◆ Make sure there is no children, pets or other objects under the backrest or legrest. ◆ Please be seated properly while using the appliance. ◆ Do not drag or push the chair or roll on its caster on wood floor or carpet to avoid damage.
 PROHIBITED	<ul style="list-style-type: none"> ◆ Do not stand on or stack heavy objects on the footrest. ◆ Do not fall into sleep while the product is operating. ◆ Avoid using the product under the influence of alcohol. ◆ Never drop or insert any object into any openings. ◆ If there is any smoke or unusual smell while using, stop using immediately, unplug the power cord.
 NO DISASSEMBLY	<ul style="list-style-type: none"> ◆ Do not disassemble this product yourself to avoid failure. ◆ Do not dismantle, fix or modify the yourself, please contact authorized dealer or service agent.

TROUBLE SHOOTING

No.	Symptoms	Possible Causes	Possible Solutions
1	Noise is heard while in use	This sound is normal and comes from the motor or massager rubbing against the cloth cover	No need to take any measures
2	Appliance does not start	The power cord is not secured into the socket	Insert the power plug properly into the power socket
		Power switch is off	Turn on the switch
		The fuse is blown	Replace only with a fuse of same type and rating
3	Airbag malfunction	The air hose is blocked	Straight the air hose and clear out the blockage
4	No music comes from the speaker	The volume is turned to the lowest	Bluetooth didn't connect with music device
		Adjust the speaker volume from the mobile devices	Reconnect Bluetooth
5	Backrest or footrest can not raise or recline	Excessive load has been pressed on the backrest or legrest	Reduce the load and try again

If problem remains, please contact the dealer for maintenance.

Important: Do not attempt to repair this product yourself, our company shall not be liable for the injury or damage caused by any servicing without authorization.

Thank you for your cooperation.

CARE AND MAINTENANCE

Care and Maintenance Instructions

- ▶ To treat stains on back panel, armrest, footrest, plastic parts or air hose, spot clean with mild detergent foam, then wipe it with a dry cleaning cloth.
- ▶ To treat stains on controller, power box, spot clean with a dry cleaning cloth.
- ▶ To treat stains on back cushion or pillows, use a water-based upholstery cleaner only, wipe it with moist cloth, then air dry.
- ▶ To clean the foot/calf unit covers, remove it from the chair, hand wash with a mild detergent, then line dry.

CAUTION

- ▶ Pull out the power cord from the power strips before care and maintenance. To avoid electrical shock or injury, do not touch the power cord with wet hands. Make sure no detergent enter into the power box while cleaning.
- ▶ Do not use benzene, thinner or other solvents on your product, it may cause fading or damage to the product.
- ▶ Do not iron the upholstery.

Storage Methods

- ▶ Keep the product free from dust. Cover the product with a dust-free cloth to prevent collection of dust if not in use of a long period of time.

CAUTION

- ▶ Do not leave this product exposed to direct sunlight for long periods of time. This may cause fading or damage.

Warm Tips

During daily use, please check for the following symptoms:

- ▶ Burnt smell.
- ▶ The product experiences unusual power ON/OFF when touching the power cord.
- ▶ Hot power cord.
- ▶ Other abnormal symptoms.

CAUTION

- ▶ Please stop using the product to avoid breakdowns or accidents if any above symptom spotted.
- ▶ Switch off the power button and disconnect the plug, contact the local distributors or supplier for repair.
- ▶ All other servicing except above care and maintenance should be serviced by an authorized dealer or service center.

WARNING

Pull out the power cord from the power strips before care and maintenance. To avoid electrical shock or injury, do not handle the power cord with wet hands. Do not try to dismantle or repair the product yourself, please send your massage chair to the authorized service center.

NAME AND FUNCTION OF EACH COMPONENT

External Structure

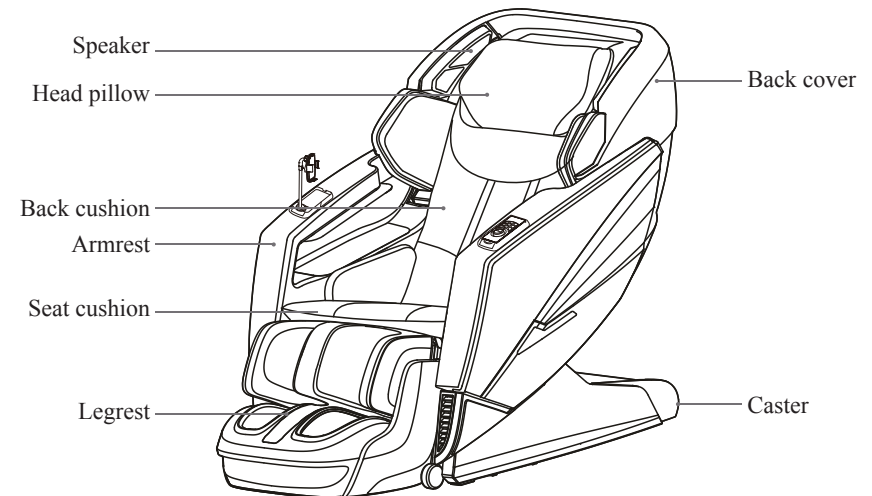

Internal Structure

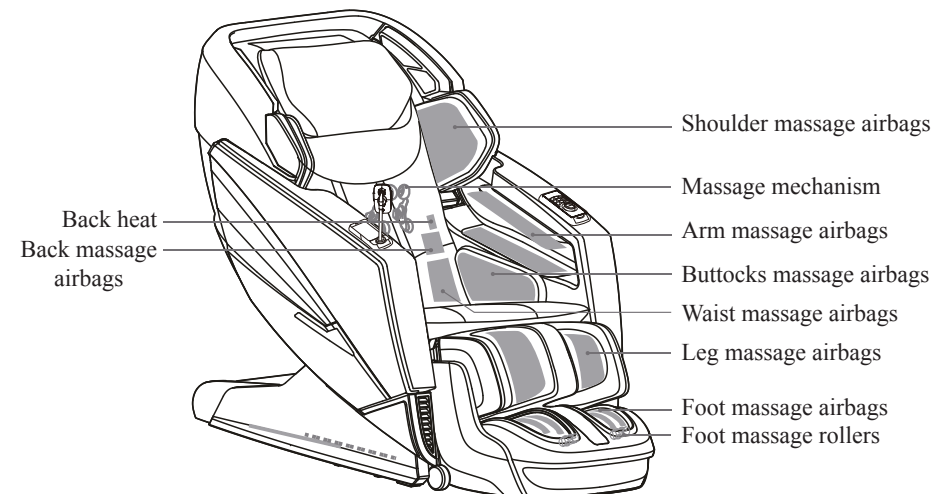

▶ NAME AND FUNCTION OF EACH COMPONENT

Controller

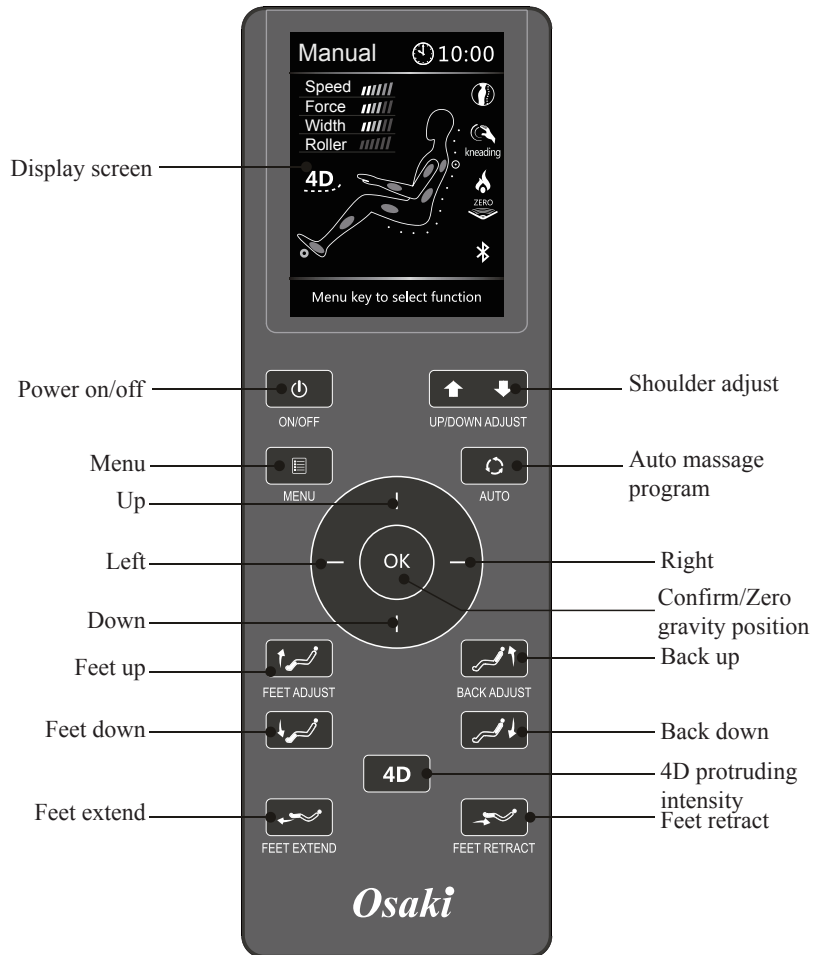

▶ APP DOWNLOAD AND INSTALLATION

Android/Apple iOS System

- ▶ Supplier will email the app to customer, download it to your device and have it set up. while setup completed, open it and switch the Bluetooth to "ON", pair it with the massage chair. (Note: Version of Android/Apple iOS System device need to be with Bluetooth function)

⚠ CAUTION



- ▶ The massage chair power and the Bluetooth need to set to On while pairing.
- ▶ If the pairing failed, try to connect again.

Prerequisites

- ▶ Tablet PC and Smart phone must have Bluetooth function.
- ▶ Android system version need to be above 2.2
- ▶ Apple iOS System need to be a 10 or later version.

► PREPARATION BEFORE USING

Footrest Extends/Retracts

- ▶ Press and hold “” “” button on the Armrest Control Panel to extend or retract the footrest to the length you desire for better massage experience, release the button to fix the position.

Footrest Extended 

Footrest Retracted 

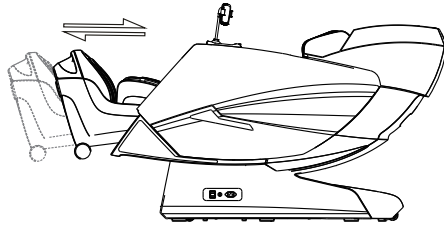

- ▶ A footrest sensor is set at the bottom of footrest, the footrest will adjust the length automatically once the chair started.

WARNING

- ▶ Do not play on the massage chair or operate it improperly.
- ▶ Ensure there is no obstruction when raising or reclining the backrest and footrest.
- ▶ Do not place foot, fingers or any other objects in the space between the seat and the backrest/footrest when it is in the reclining or raising motion.
- ▶ Ensure massage chair is restored back to its original position before getting off the massage chair.

Audio Function

To play sound, turn on Bluetooth on your Android/Apple iOS device and place the massage chair in discovery mode to pair.

After Use

- ▶ Turn off the power switch and unplug the massage chair from the electrical outlet while not in use to avoid children power on the massage chair accidentally.
- ▶ When not in use for a long period of time, we recommend that the chair be covered, the power cord be coiled and that the unit be placed in an environment free of dust and moisture.

► NAME AND FUNCTION OF EACH COMPONENT

Instructions of Controller

Power: Press this button to power on/off the controller.

- ▶ Press this button while connected to power to show the menu display, the LCD Screen is lit up, use the UP/DOWN/LEFT/RIGHT buttons to navigate the screen, press OK to select.
- ▶ Press this button again to turn off the product.

Menu

- ▶ Display the Auto Program, Manual Program, 4D Massage, Airbags, Heat and Settings. (Check the Display Menu for detailed information)

Shoulder Position Adjustment (slightly adjust mechanism up/down the shoulder)

- ▶ Press and hold Position UP/DOWN button to adjust the rollers to the desired position while in Manual Point massage mode.
- ▶ Press and hold Position UP/DOWN button to adjust the rollers to the desired position while in the body scan procedure.

Auto Program

- ▶ Press to display the auto mode menu. when an auto program is running, press this button to toggle among the auto programs. the active program displays at the top of the status screen.

Navigation



- ▶ Use the UP/DOWN/LEFT/RIGHT arrow buttons to navigate the screen, press OK to select.
- ▶ While massage program is running, press OK button to turn ON/OFF Zero Gravity position, press UP/DOWN button to change the Mechanism massage speed; press LEFT/RIGHT button to change the Airbag massage intensity.

4D Protruding Intensity

- ▶ While manual massage program is running, press this button to change the 4D protruding intensity.

Feet Up

- ▶ Press and hold to raise the footrest, release the button to stop.

Feet Down

- ▶ Press and hold to lower the footrest, release the button to stop.

▶ NAME AND FUNCTION OF EACH COMPONENT



Back Up

- ▶ Press and hold to raise the backrest, release the button to stop.



Back Down

- ▶ Press and hold to lower the backrest, release the button to stop.



Footrest Extends

- ▶ Press and hold to extend the footrest, release the button to stop. (Make sure there is no obstruction in advance)



Footrest Retracts

- ▶ Press and hold to retract the footrest, release the button to stop

⚠ WARNING

- ▶ After using, press Power button to restore the chair, press any button on the controller to stop the restoration, press Power button again for further operation.

Display Screen Instructions

▶ Auto Massage Program

Press to display the Auto Program menu, press this button to toggle among 12 Auto Programs: Chair Yoga, Gentle Yoga, Power Yoga, Royal Treatment, Stress Relief, Gentle Care, Neck & Shoulder, Back & Spine, Waist & Hip, Morning Buzz, Refreshing Nap and Sweet Dreams. Press OK to enter the program you desire. Selected program will show on the home screen. (Check below display photo for reference)

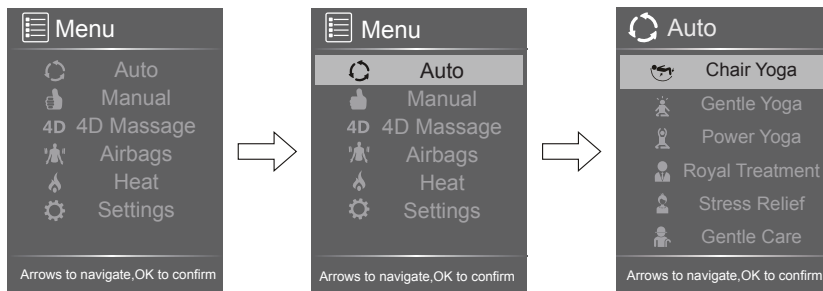

Chair Yoga: Designed for muscles relaxation after sports activity and exercise, it helps to ease muscles tension, promote body circulation and facilitate sports recovery.

Gentle Yoga: Inspired by Thai style massage, featured in extension and stretching, this program uses strong kneading and stretching technique to relax tired muscles and keep them flexible.

Power Yoga: Designed for improving nap and sleep quality, this program adopts gentle massage techniques to relieve body fatigue.

▶ PREPARATION BEFORE USING

Commissioning

- ▶ Use the controller to recline the backrest to its lowest position, raise and extend the footrest to its top position, make sure there is enough clearance before commissioning.
- ▶ Return the backrest and footrest back to its default position after commissioning and turn off the power switch. To choose the massage program, please check the Instructions of Controller and Instructions of Display Screen for reference.

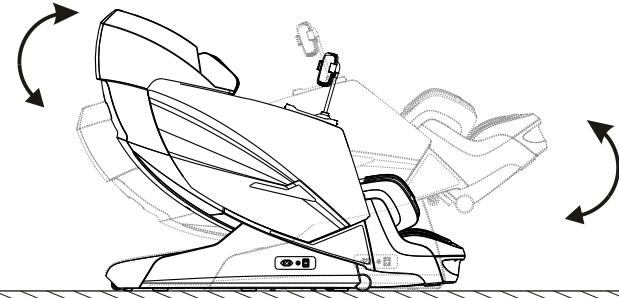

Before Sitting in the Chair

- ▶ Ensure the footrest is well assembled before sitting on the massage chair.
- ▶ Ensure the massage chair is returned to its original position before sitting on it. If there is any part not in default position, please turn off the massage chair to allow it to restore.

⚠ CAUTION

- ▶ Do not take seat while the footrest is lifted.
- ▶ Do not put excessive load on the footrest to avoid damage.

⚠ DANGER

- ▶ Improper connection of the equipment grounding conductor can result in a risk of electric shock. Check with a qualified electrician or serviceman if you are in doubt as to whether the product is properly grounded. Do not modify the plug provided with the product – if it will not fit the outlet, have a proper outlet installed by a qualified electrician.

⚠ Grounding

- ▶ This massage chair belongs to Level One electrical appliance, make sure to use three-core power supply socket and to guarantee the ground wire connected to the power supply socket has obtained good ground connection to avoid electric leakage, electric shock and some other negative effect during use.

► PREPARATION BEFORE USING

Move Method

- ▶ Roll the chair on its casters to the desired location.
- ▶ Incline the backrest to upright position.
- ▶ Turn off the power switch and unplug the appliance from the electrical outlet.
- ▶ Using two people, push down on the backrest and lift up on the front side by grabbing the moving Holder located to the front bottom of the armrest, roll the chair on its casters to the desired location (check the sketch for reference).

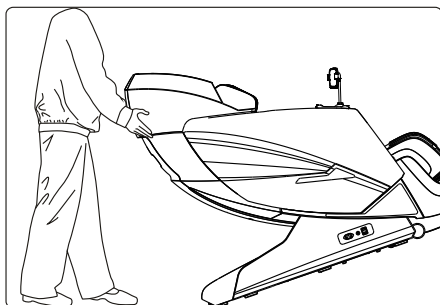

⚠ CAUTION

- ▶ Do not move the chair when there is user inside.
- ▶ To carry this product, do not lift by the footrest or armrest, hold the chassis and steady the backrest (have 4 or more people to carry the product).

Connect to Power

- ▶ Connect this appliance to a 3-wire properly grounded outlet.
- ▶ Turn on the main power switch by the right hand side of the massage chair.

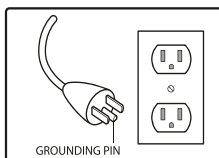

⚠ CAUTION

- ▶ Please verify that there is no damage to the supply cord before switching on the massage chair.
- ▶ Please verify that the main power switch is turned off before connecting to power.

► NAME AND FUNCTION OF EACH COMPONENT

Royal Treatment: Designed for the ordinary working persons, this program helps to rejuvenate both physically and emotionally.

Stress Relief: Designed to help to ease the pain and stiffness in neck and shoulders, combined with curvature design of the backrest, this program targets the rollers at the deep tissue of neck and shoulders.

Gentle Care: Focusing the massage on the lumbar vertebra, this program helps to soothe the tension and keep the vitality of muscles.

Neck & Shoulder: Combination of deep tissue massage techniques; focuses on muscles in the neck, shoulders, and upper back.

Back & Spine: Combination of deep tissue massage techniques; focuses on muscles along the spine, upper and lower back and lumbar.

Waist & Hip: Combination of deep tissue massage techniques; focuses on muscles on the lumbar, waist, thighs, and around the hip joints.

Morning Buzz: Stimulating all-over massage using various techniques; energizes and encourages a bright attitude.

Refreshing Nap: Soothing all-over massage using various techniques; soothes tension and refreshes the body.

Sweet Dreams: Gentle, calming all-over massage using various techniques; encourages relaxation in preparation for a restful sleep.

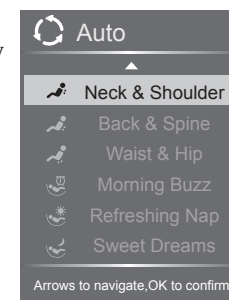

► Manual Massage Programs

Press Manual from Menu display, press UP or DOWN button to navigate among: Mode, Part, Width, Speed, Roller and ZeroG.

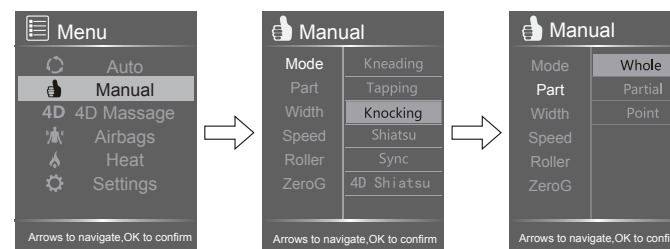

▶ NAME AND FUNCTION OF EACH COMPONENT

Massage Mode: Press Mode from Manual display, press RIGHT button then press UP or DOWN button to navigate among: Kneading, Tapping, Knocking, Shiatsu, Sync and 4D Shiatsu. Press OK button to enter the setting you desire. Selected mode will show on the home screen.

Massage Part: While Manual massage program is running, press this button to navigate among: Whole, Partial and Point massage regions.

Back Mechanism Massage

Width: Press Width from Manual display, press RIGHT button then press UP or DOWN button to navigate among: Wide, Medium and Narrow mechanism roller width. Press OK button to enter the setting you desire. Selected width will show on the home screen.

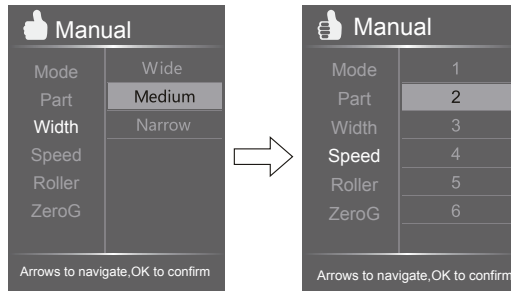

Back Mechanism Massage Speed: Press Speed from Manual display, press RIGHT button then press UP or DOWN button to navigate among: level 1, 2, 3, 4, 5, 6 Mechanism massage speed. Press OK button to enter the speed level you desire.

Underfoot Roller Speed: Press ROLLER from MANUAL display, press RIGHT button then press UP or DOWN button to navigate among: foot roller speed level 1, 2, 3, or OFF (deactivate foot roller). Press OK button to enter the speed level you desire.

Zero Gravity: Press ZeroG from MANUAL display, press RIGHT button then press UP or DOWN button to activate or deactivate Zero Gravity Position. Press OK button to enter the setting you desire.

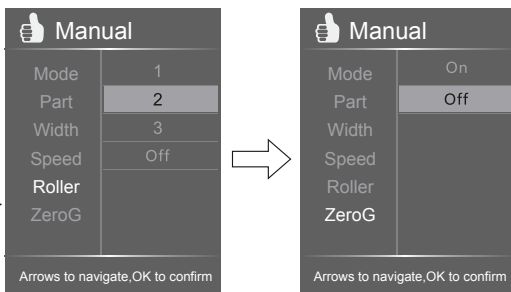

▶ PREPARATION BEFORE USING

- ▶ Insert the lower end of mobile phone holder into the socket, turn the locknut clockwise to secure the holder into place (make sure the cradle face to the chair side).
- ▶ Connect the clamp arm power cord with the cradle charging port.

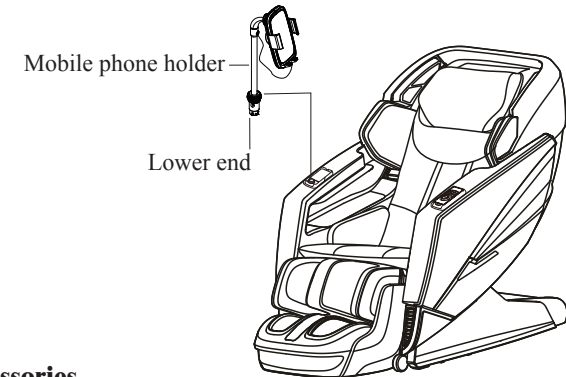

Step 6: Other Accessories

- ▶ Connect the power cable to the product power socket located at the bottom of right armrest.
- ▶ Switch ON the power located at the bottom of right armrest, raise the backrest of the product to fully upright position.

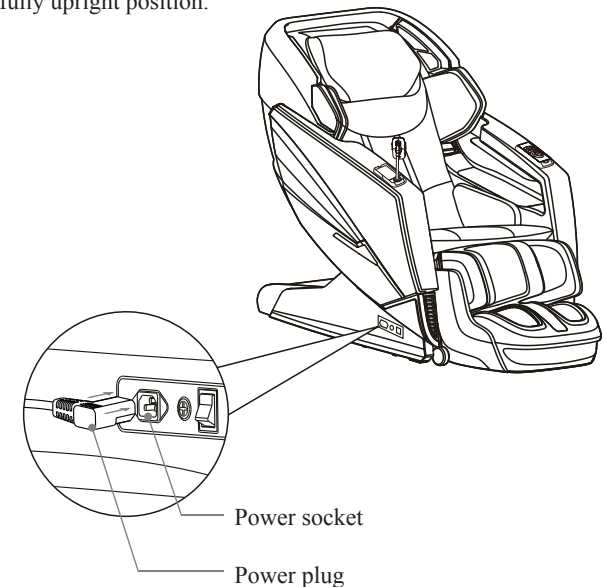

► PREPARATION BEFORE USING

- Raise the legrest unit, thread the air hose into the air nozzle, and fit legrest drive wire connector into the drive wire port, make sure they are well secured. (Check below illustration for reference)
- Zip up the cover and cushion.

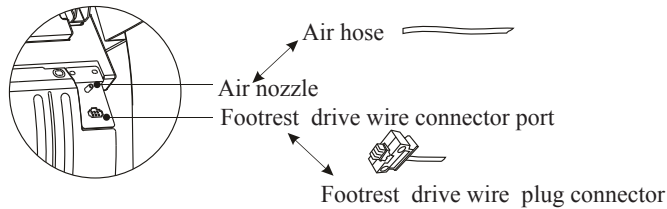

Step 4: Install the controller unit

- Connect the remote control cable to the massage chair's port, then tighten the screw cap clockwise to secure the connector in place. (Check below illustration for reference)

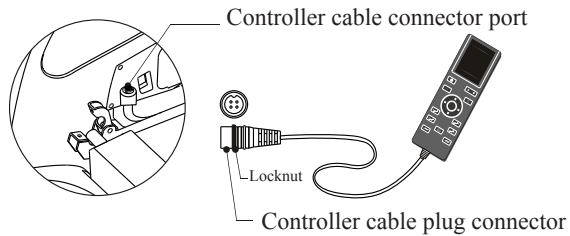

Step 5: Install mobile phone holder

- Unpack the cartons: take out the mobile phone holder assembly parts out of the cartons. Unscrew the locknut and thread it onto the clamp arm, put the ball joint into the cradle threaded hole, then tighten the screw.

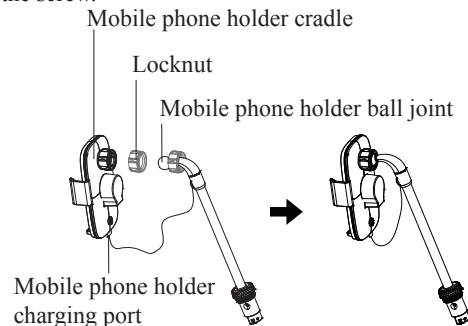

► NAME AND FUNCTION OF EACH COMPONENT

► 4D Massage

Press 4D MASSAGE from MENU display to enter 4D Massage Force display.

Force-4D protruding intensity:

While Manual 4D massage program is running, press this button to navigate among level 0, 1, 2, 3, 4, 5 to change the 4D protruding intensity.

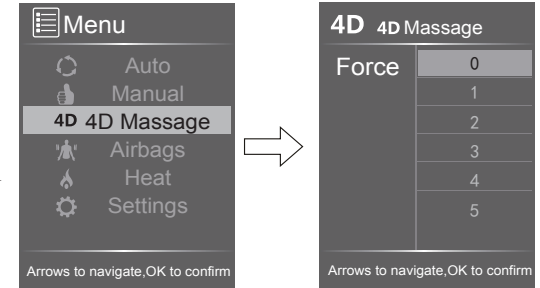

► Airbags

Press AIRBAGS from MENU display to show the AIRBAGS display, press RIGHT button then press UP or DOWN button to navigate between: PART-Air pressure region and FORCE-Air pressure intensity. Press OK button to enter the setting you desire.

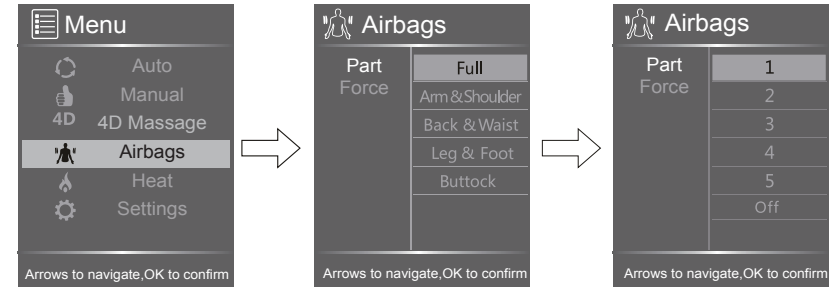

Part-Air pressure region: Press PART from AIRBAGS display, press RIGHT button then press UP or DOWN button to navigate among: Full, Arm&Shoulder, Back&Waist, Leg&Foot, Buttock airbag positions. Press OK button to enter the airbag position you desire.

Force-Air pressure intensity: Press FORCE from AIRBAGS display, press RIGHT button then press UP or DOWN button to navigate among: level 1, 2, 3, 4, 5 airbag intensity, or Off (deactivate airbag intensity function). Press OK button to enter the airbag setting you desire.

► Back Heat

Press HEAT from MENU display to show the HEAT display, press RIGHT button then press UP or DOWN button to navigate among: 1, 2, 3 heat level, or OFF (deactivate heat function). Press OK button to enter the heat setting you desire.

▶ NAME AND FUNCTION OF EACH COMPONENT

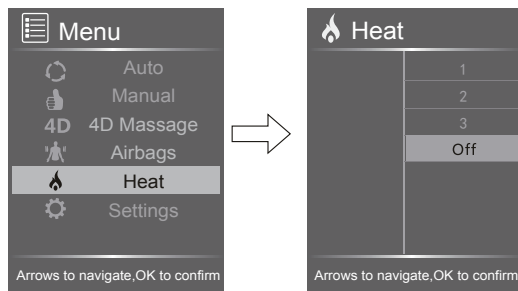

▶ Settings

Press **SETTINGS** from **MENU** display, press **OK** button to enter **Settings** display, then press **UP** or **DOWN** button to navigate among: **Time**, **Language**, **Bluetooth**, and **Charging**.

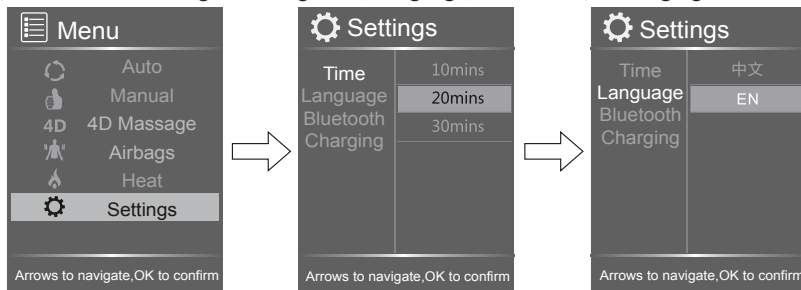

Time: Press **TIME** from **SETTINGS** to show available timer: 10mins, 20mins, 30mins. press **RIGHT** button then press **UP** or **DOWN** button to navigate, press **OK** button to enter the timer you desire, 20mins is the default setting.

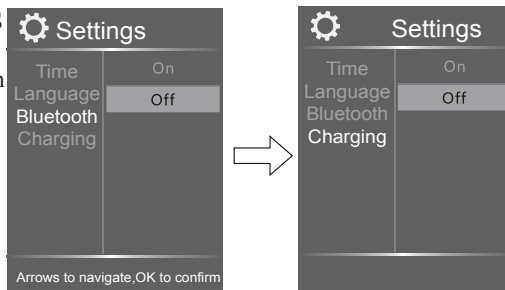

Language: Press **LANGUAGE** from **SETTINGS** to show available languages: 中文, EN. press **RIGHT** button then press **UP** or **DOWN** button to navigate, press **OK** button to enter the Language you desire.

Bluetooth: From **BLUETOOTH**, press **RIGHT** button then press **UP** or **DOWN** button to activate or deactivate Bluetooth function. press **OK** button to enter the setting you desire.

Charging: From **CHARGING**, press **RIGHT** button then press **UP** or **DOWN** button to activate or deactivate Charging function. press **OK** button to enter the setting you desire.

Notes: All Settings listed above will be memorized when you turn off the massage chair.

▶ PREPARATION BEFORE USING

Step 3: Install the Footrest Unit

▶ Thread the inner&outer bushing onto the footrest connection pin.

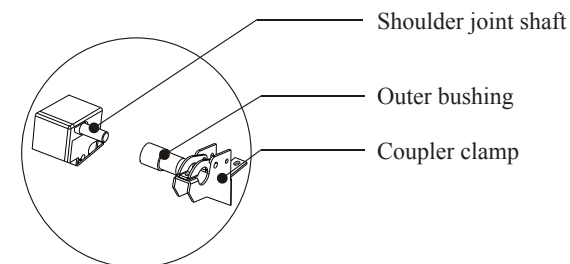

▶ Remove the screw off the coupler clamp, latch upwards to unlock it, fit the footrest joint shaft to the coupler hook and latch downwards to lock it, tighten the screw. (Check below illustration for reference)

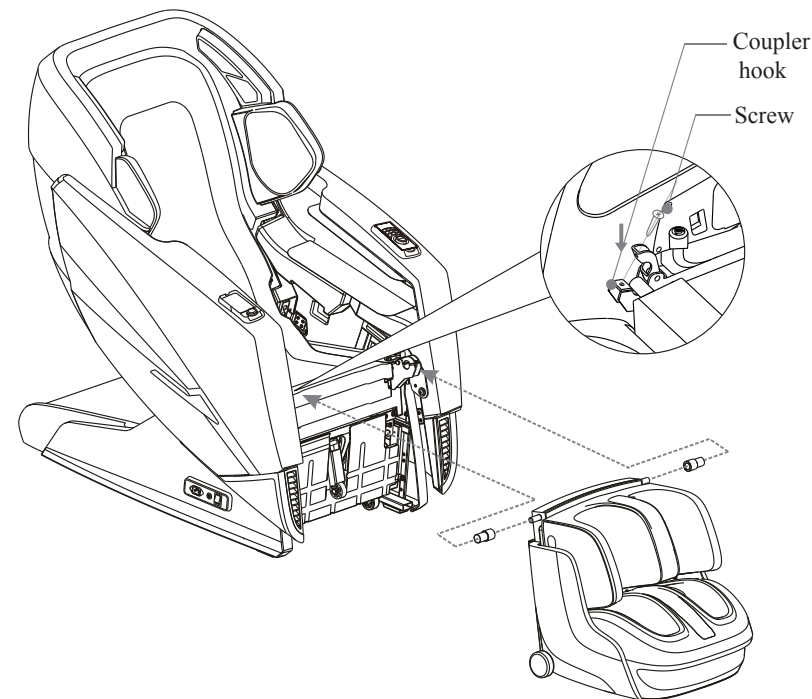

PREPARATION BEFORE USING

Installation Methods

Step 1: Take all massage chair units out of the cartons

- ▶ Unpack the cartons:take out all upholsteries and accessories out of the cartons.
- ▶ Before beginning installation,please verify that all components are included(check with the packing list carefully)

Step 2: Install Armrest Unit

- ▶ Connect the numbered air hoses to the matching numbered nozzles on the armrest, and fit the colored wire plug into the matching Port .
- ▶ Attach the armrest mounting bracket onto the chair body pin,line up the armrest with the backrest unit,press the armrest unit to connect in place.
- ▶ Fit the shim and tighten the screw to secure the armrest into place.
(Same installation method with the other side).

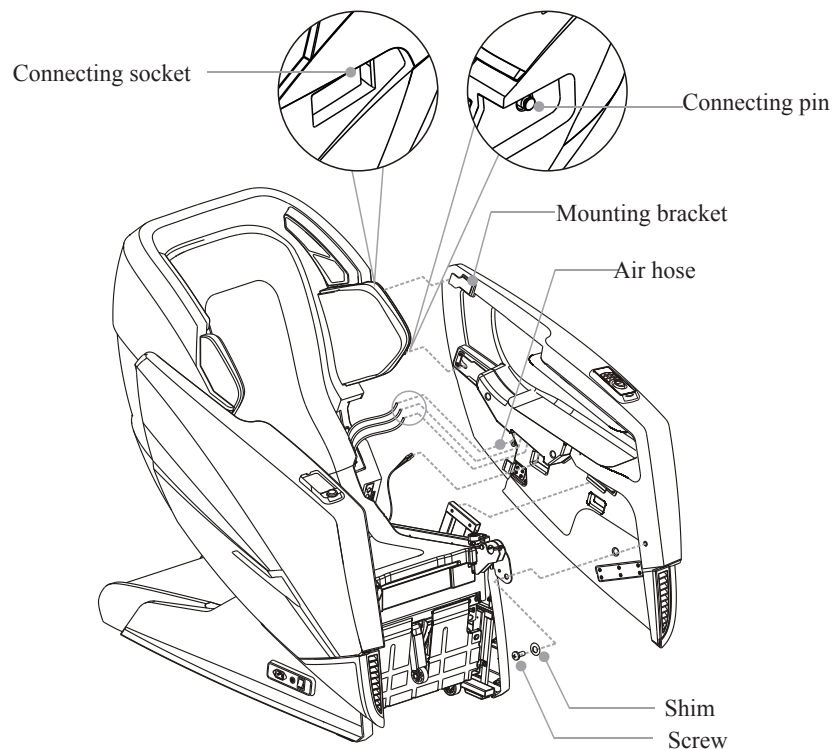

NAME AND FUNCTION OF EACH COMPONENT

Note:

- 1 In the process of Auto or Manual Setting,LCD screen will auto revert back to the homescreen after 10 seconds if there is no operation entered into the controller.

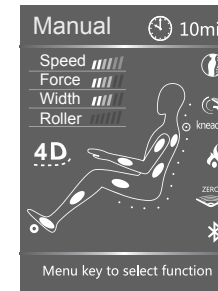

Homescreen display with the Manual program running



Homescreen display with the Auto program running

⚠ Tips

- ▶ While appliance is running,press twice MENU button to revert to homescreen.
- ▶ At the homescreen display,press LEFT or RIGHT button to adjust the airbag intensity(works in the process of both Auto and Manual program);press UP or DOWN button to adjust the massage intensity(only works in the process of Manual program)
- ▶ Press Auto button to select auto massage program.

2 Mechanism will scan shoulder position before first time running of Auto Program (check the right figure),it will start to run the desired auto program right after the completion of scanning.

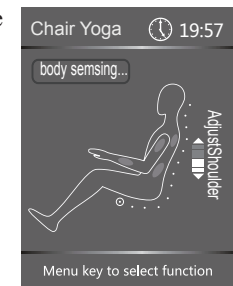

⚠ CAUTION

- ▶ Do not disassemble this product yourself to avoid product damage.
- ▶ Make sure no water or other liquid enters into the controller to avoid fault.
- ▶ Do not pinch or squeeze the controller or power cord.

▶ NAME AND FUNCTION OF EACH COMPONENT

Armrest Control Panel

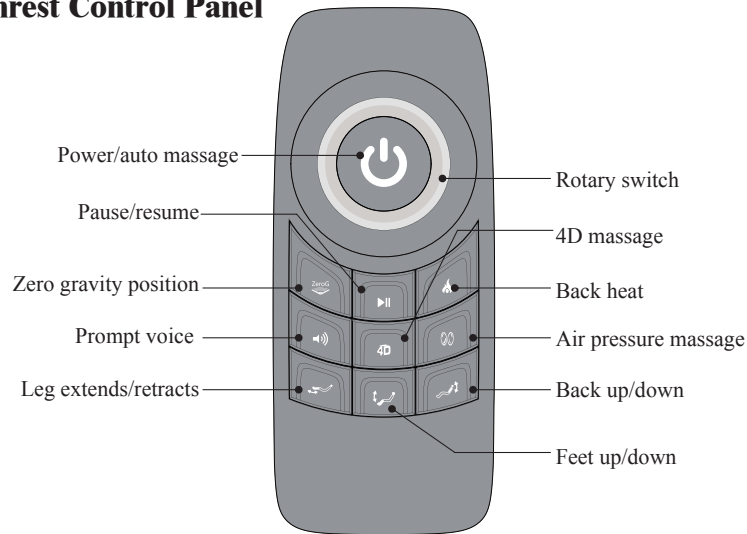

Instructions of Armrest Control Panel



Power/Auto Massage Button

- ▶ When massage chair is in sleep mode, long press this button for 3 seconds to power on the chair (white indicator surrounding the button lights up), then short press this button to start auto massage program, you may toggle among 6 pre-set auto massage programs. Long press this button again to turn off the massage chair.



Rotary Switch

Use the press button and rotary switch to achieve quick controls:

- ▶ Press the Heat button on the armrest control panel (red indicator lights up), then rotate the rotary switch to adjust the heat settings;
- Press the Prompt Voice button on the armrest control panel (red indicator lights up), then rotate the rotary switch to adjust the prompt voice volumes;
- Press the 4D massage button on the armrest control panel (red indicator lights up), then rotate the rotary switch to adjust the 4D massage intensity;
- Press the Air Pressure massage button on the armrest control panel (red indicator lights up), then rotate the rotary switch to adjust the Air Pressure massage intensity;
- Press the Footrest Extension Adjust button on the armrest control panel (red indicator lights up), then rotate the rotary switch to adjust the footrest extension;
- Press the Footrest Up/Down button on the armrest control panel (red indicator lights up), then rotate the rotary switch to adjust the footrest position;
- Press the Back Up/Down button on the armrest control panel (red indicator lights up), then rotate the rotary switch to adjust the backrest position;

Tips: Always press the quick control button first (red indicator will light up when the function is activated) then rotate the rotary switch to adjust the settings.

▶ PREPARATION BEFORE USING

Floor protection

- ▶ Please put carpet or other pad under the massage chair, in order to avoid any unpredictable impression on the floor and to reduce the noise.

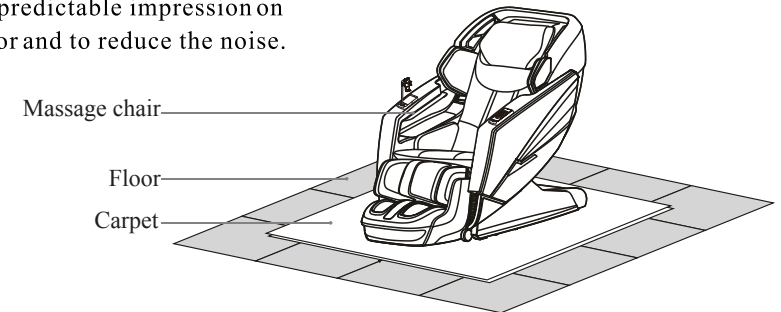

Surrounding environment



Keep the massage chair away from damp places (for example: bathroom) to avoid electric shock and serious injury. Moisture will cause serious electric failure and damage.



Keep the massage chair away from high temperature sources (for example: stove, heaters, windows) to avoid fire, discoloration or damage to upholstery material.

GROUNDING INSTRUCTIONS

This product must be grounded in the event of an electrical malfunction. Grounding provides a low resistance path for the electric current to reduce the risk of electric shock. The cord is equipped with a built-in equipment-grounding conductor and a 3-prong grounding plug. This plug must be used with an appropriate outlet installed and grounded in accordance with all local codes and ordinances.

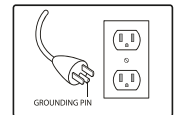

⚠ DANGER

- ▶ Improper connection of the equipment-grounding conductor can result in a risk of electric shock. Check with a qualified electrician or serviceman if you are in doubt as to whether the product is properly grounded. Do not modify the plug provided with the product – if it will not fit the outlet, have a proper outlet installed by a qualified electrician.
- ▶ This product is for use on a nominal 120-volt circuit and has a grounding plug that looks like the plug illustrated. Make sure that the product is connected to an outlet having the same configuration as the plug. No adapter should be used with this product.

GROUNDING

This massage chair belongs to Class I of the IEC Protection Class. Be sure to use a three-core power supply socket. To avoid electric shock, leakage, or other electric risk, ensure the ground wire connected to the power supply has obtained a stable ground connection.

► PREPARATION BEFORE USING

Installation Site

Clearance space for the massage chair:

- Ensure there is an adequate clearance for the installation:
 - It needs 10cm clearance for the recline of the backrest;
 - It needs 60cm clearance space for the extension of footrest and sliding forward of the chair.
- Keep it 1 meter away from the TV, radio or other audio&video appliance to avoid signal interference.

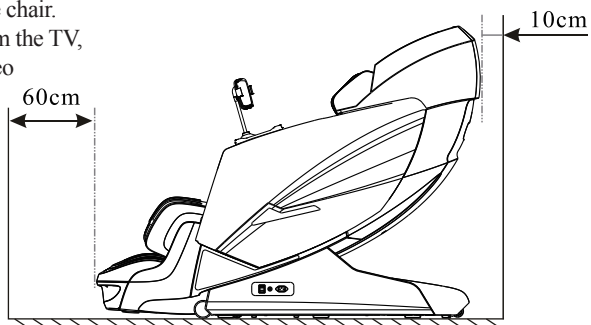

- Keep the distance between the power socket and power switch within 1.5 meter.

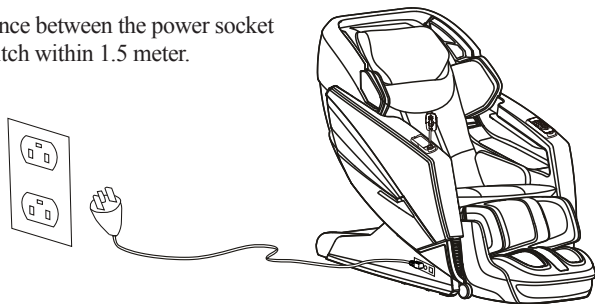

⚠ CAUTION

- Keep the distance between the power socket and power switch within 1.5 meter to avoid damage of power cord while massage chair sliding forward.
- Straighten the power cord while in use to avoid tangle or damage.
- When the massage chair sliding forwards or back, please check to make sure there is no children, pets or other obstacles around to avoid accident.

► NAME AND FUNCTION OF EACH COMPONENT



Zero Gravity Position Button

- Press this button to put the chair in zero gravity position, the button indicator turns red; press again to close the Zero Gravity Position, the button indicator turns green.



Pause/Resume Button

- Press this button to pause the massage chair function, press again to resume the function.



Heat Button

- Press this button to turn on back heat, the button indicator turns red; press again to turn off back heat, the button indicator turns green.



Prompt Voice Button

- Press this button to turn on prompt voice, the button indicator turns red; press again to turn off prompt voice, the button indicator turns green.



4D Massage Button

- Press this button to turn on 4D massage, the button indicator turns red; press again to turn off 4D massage, the button indicator turns green.



Air Pressure Massage Button

- Press this button to turn on air pressure massage, the button indicator turns red; press again to turn off air pressure massage, the button indicator turns green.



Footrest Extension Adjustment Button

- Press this button to turn on footrest extension adjust function, the button indicator turns red; press again to turn off footrest extension adjust function, the button indicator turns green.



Feet Up/Down Button

- Press this button to turn on footrest up/down adjust function, the button indicator turns red; press again to turn off footrest up/down adjust function, the button indicator turns green.



Back Up/Down Button

- Press this button to turn on backrest up/down adjust function, the button indicator turns red; press again to turn off backrest up/down adjust function, the button indicator turns green.

FUNCTIONS AND FEATURES

1.Sliding-Reclining Linkage Mechanism

It can Slide forward and reclines to save space and provide utmost relaxing position.

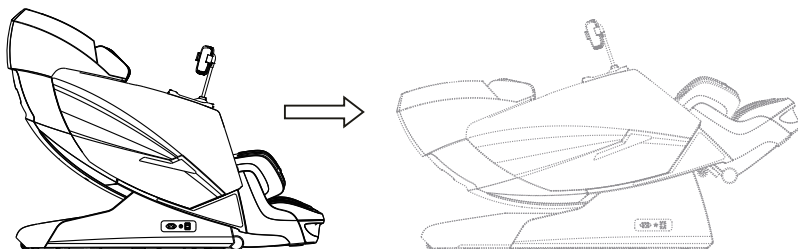

2.Zero Gravity Position

At such a weightless position that the height of the legs slightly higher than the upper body,the weight of body can evenly distributed throughout,reducing the pressure of the spine and joints both physically and mentally.

3.Human Hand Quad Style Massage Rollers

Innovative Human hand quad style massage rollers and L-shaped guiding track conform to ergonomic principle.

4.Auto/Manual Footrest Extension

The footrest can extend automatically to customize the user's leg length,you may also use the controller button to adjust the footrest according to your needs.

The footrest can extend by 17cm automatically for various users of different height ranges.

5.Air Pressure Massage

Whole body air pressure massage for shoulders,arms,back,waist,hips,legs and feet.

6.Roller Massage for Foot

3 underfoot rollers provide all-direction massage for the reflex zone.

7.Versatile Massage Techniques

Mimic human hand Kneading,Tapping,Knocking,Shiatsu,Sync and 4D Shiatsu massage techniques for custom-tailored relaxation.

8.Bluetooth Audio Function

Tune in your favorite music through the media devices to immerse yourself in soothing massage and music.

9.Super Long SL-Style Guide Track

FUNCTIONS AND FEATURES

10. Charging Function

You can put the wireless charging phone into the wireless charging receptacle to charge the device when needed/
Or use the USB port next to the mobile phone/controller organizer for charging.



11. Calf Kneading&Rubbing Function

Stress relieving kneading and rubbing massage covers from calf to knee.

Mobile Phone Holder

When connected to power,the red and green indicator light up and goes off soon, wait 3-5 seconds and touch the bottom grip(or release button) to clamp the cradle (it defaults to clamp for the first touch),touch again to slide open the left and right arms of cradle. the red indicator is steady during charging and it blinks when not in charging.

Red indicator goes off and green indicator lights up when charging is completed.

