

KAHUNA  CHAIR®

KAHUNA MASSAGE CHAIR

LM 7000

MANUAL





CONTENTS



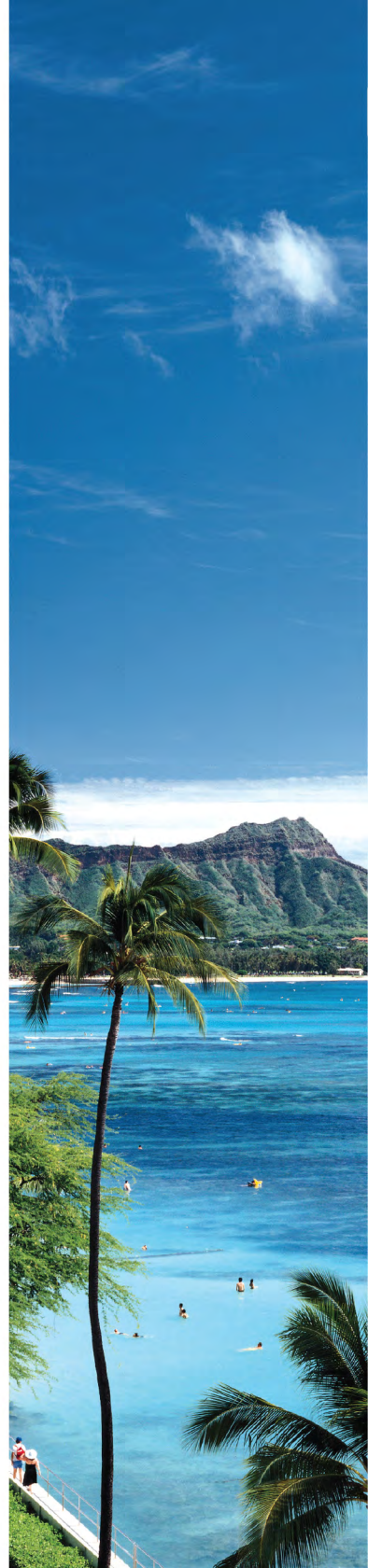

Please read and follow all safety instructions listed in this user manual prior to use. Basic precautions should always be considered when operating an electrical appliance.

Safety Instructions	2
Product Components	7
Chair Installation	8
Remote Controller	11
Operation Guide	12
Troubleshooting	20
Maintenance	21
Product Specifications	22



- Please read this manual carefully to make sure the installation and operation of the massage chair is done correctly.
- “Safety Instructions” are provided for important safety information. Both Warning and Caution are important safety caution, please be more cautious.

	Warning	This sign indicates warning of causing possible death or injury to body.
	Caution	This sign indicates caution of causing possible pain or damage to body.

	This sign indicates forbidden behavior.
	This sign indicates must follow instruction to operate.
	This sign indicates self disassembly is forbidden.
	This sign indicates correct operation of cable.

- The following should be kept for any further references.

SAFETY INSTRUCTION



Warning

	<ul style="list-style-type: none"> • Osteoporosis patient ; • People with heart disease including embedded pacemaker or other medical electronic device inside the body ; • For pregnant women or people with health issues, please consult with doctor before use ; • Patients with a high fever forbid to use this machine. • Perceptual disabilities patients forbid to use this machine. • People over 80 years old forbid to use this machine. • Kids are not allowed to use the chair ; • Don't operate the chair after the use of alcohol. • Please don't sleep in the chair. • Don't use the chair when your body is wet. 	<p>People who are not suitable to use the chair</p>
	<ul style="list-style-type: none"> • Make sure there are no kids or pets or other objects around (under, behind or in front of) the chair at the moment of backrest, leg-rest up/down or leg-rest retraction/extension from reclining position. • During operation, if body is being abnormal, please stop the operation and go consult with your physician. • Please do not take strong massage on the head. • Do not massage belly or knees, be careful when massaging neck. • Children or pets are not allowed to play on the chair especially during massage. Standing or sitting on the back or armrest is not allowed either. • Those who move around with difficulty or can't express themselves must be taken care of strictly and continuously during massage. 	<p>Accident /injury</p>
	<ul style="list-style-type: none"> • Insert the plug of the chair into correct and suitable power socket. • Make sure the plug is completely inserted into the socket to reduce short circuit or fire risk. • Unplug the power when not in use, stop all massage functions and turn off on/off key before unplugging. 	<p>Fire and electric shock</p>
	<ul style="list-style-type: none"> • Massage cushions of the chair are not allowed to fold for storage. • The machine is forbidden for no-load running for a long time. 	<p>Accident</p>
	<ul style="list-style-type: none"> • Power cord, plug, socket can't be used in broken or loose contact condition. • Don't use other electric power except rated voltage in case of fire, electric shock or any breakdown. • Any broken, re-process, knotted, twisted power cord or pressed under heavy cargo is not allowed to use. 	<p>Fire and electric shock</p>





Warning

	<ul style="list-style-type: none"> • If the chair is dysfunctional, or is broken, splashed with water or falls into water, please have it repaired by professional repairman or send the chair to assigned service agent. Self-modification, disassembly or maintenance is forbidden. • If power cord or plug is damaged, please don't replace it yourself, please contact us or appointed dealer for replacement. • To avoid electric shock or body injury, please don't open or disassemble any part of the chair, there is not any attached part of the chair for maintenance by customers. • Check leather or cloth material on the back and other areas is broken or not. If broken, even though it is small, please stop using the chair, unplug the power and have it repaired. 	<p>Disassembly and maintenance</p>
--	--	------------------------------------





Caution

	<ul style="list-style-type: none"> • Please operate the chair when it is flat or on leveled place • Position the chair 4 inches from the wall to allow for sufficient space to recline up and down. • The maximum suggested operating time is 20 mins. 5 mins for each position beginning with the slight- step massage. Along continuous massage in the same position may cause uncomfortable feeling. • Before sitting on the chair to avoid injury please inspect everything to confirm that the massage heads are in the correct position. • Please make sure that the power switch is on "OFF" position before inserting the plug into the socket. • Turn off all controls before removing plug from outlet. • Make sure the plug is completely inserted into the socket. • Checking whether there are any damages on the wire and make sure there are no water or rubbish on the wire. • Installing the wire in a correct way. The plug must be inserted into socket with   the connect, the connect couldn't be bent or cut off. 	<p>To avoid sudden falling.</p> <p>To make sure the back lying.</p> <p>Too long time massage is bad for your body.</p> <p>To avoid accidental injury.</p> <p>To avoid the accident when turn on the power.</p> <p>To reduce short circuits and any fire hazard.</p> <p>To avoid electric shock in any leakage or breakdown.</p>
	<ul style="list-style-type: none"> • Don't use or store the chair in the wet environment like near the swimming pool, or bathroom. • Keep the chair and remote control dry at all time. • Don't use the chair when your body is wet. 	<p>To avoid leakage or electric shock.</p>

SAFETY INSTRUCTION

Caution

	<ul style="list-style-type: none"> • Don't press with hands or step on the massage heads with feet. • Don't put hands between the working massage heads. Don't put hands or feet in the gap of mechanical parts. Don't drop or insert anything into the slot of massage chair. • Don't stand or sit or put anything on the backrest, armrest, or leg-rest. • Don't stand on the chair during operation. Don't move the chair during operation. • Don't pull out the plug or turn off the power during operation. Don't put your hands or head between leg-rest or beneath. Don't use the massage chair while wearing hair ornaments. • Don't put hard things in pocket when take buttocks and huckle massage. • Don't sit or press on the backrest when the chair is in reclining position. • Don't use on bare skin or wearing thin clothes, thin clothes may cause better massage effect, But it also may cause irritation to the skin or cryogenic burns. 	<p>To avoid accidents or injury</p>
	<ul style="list-style-type: none"> • Keep the chair away from heat, wet, sharp things and corrosive, inflammable, explosive environment. • To use electric blanket or other heating products on the chair is forbidden. • Don't put in the space of dust serious or corrosive gas environment. • Don't put the chair in a small space places or use in the bad air circulation places. 	<p>To avoid fade, discolor on upholstery or hardened, deteriorated on PU.</p>
	<ul style="list-style-type: none"> • Keep the chair away from stove or other heating products. • Don't put the chair directly under the sun or other high temperature places. • Don't use the chair in outdoor. 	<p>To avoid electric shock.</p>
<ul style="list-style-type: none"> • Make sure to install the wire in correct way(Incorrect install way may cause electric shock. If you don't know how to install, please find a professional electrician) • Don't use plug adapter (If the enclosed plug doesn't match with socket, please don't change the plug by yourself and find a professional electrician to install a matched socket.) 	<p>To avoid electric shock.</p>	

Caution

	<ul style="list-style-type: none"> • Unplug the power before cleaning the chair. • Unplug the power after using the chair. 	To avoid electric shock or fire hazard.
	<ul style="list-style-type: none"> • Unplug the power when any damage on the power. 	
	<ul style="list-style-type: none"> • Hold the plug to unplug the power but to not try to pull the wire to unplug the power. 	To avoid accidents
	<ul style="list-style-type: none"> • Please turn off the power switch and unplug the power after massage. 	
	<ul style="list-style-type: none"> • Unplug the power immediately when electricity goes off. 	



- Warning :**
1. Do not use it when wet.
 2. The disabled may need supervision.
 3. The chair has heat function, people who are insensitive to heat must pay high attention.

| Grounding instruction |

The chair is equipped with a cord having a grounding conductor. The plug must be plugged into an appropriate socket that is properly installed and matched with the plug.



Earth wire is not allowed to be in these places

Gas pipe: probably cause explosion or fire.
 Phone wire and lightning rod: probably cause electric shock and fire when thundering.
 Water pipe: earth wire is useless where there are plastics

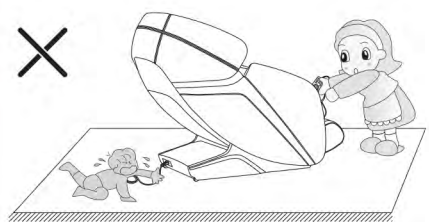
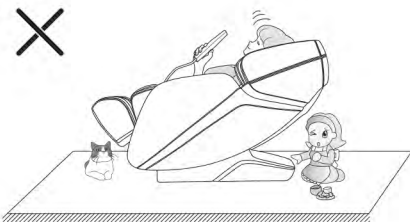

PRODUCT COMPONENTS

| Main body diagram (Front) |

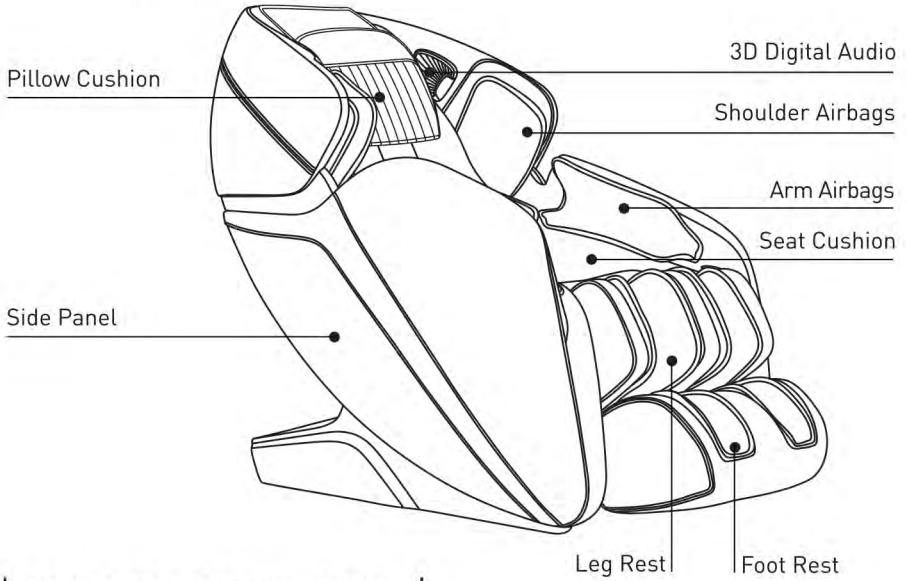

| Main body diagram (Rear) |

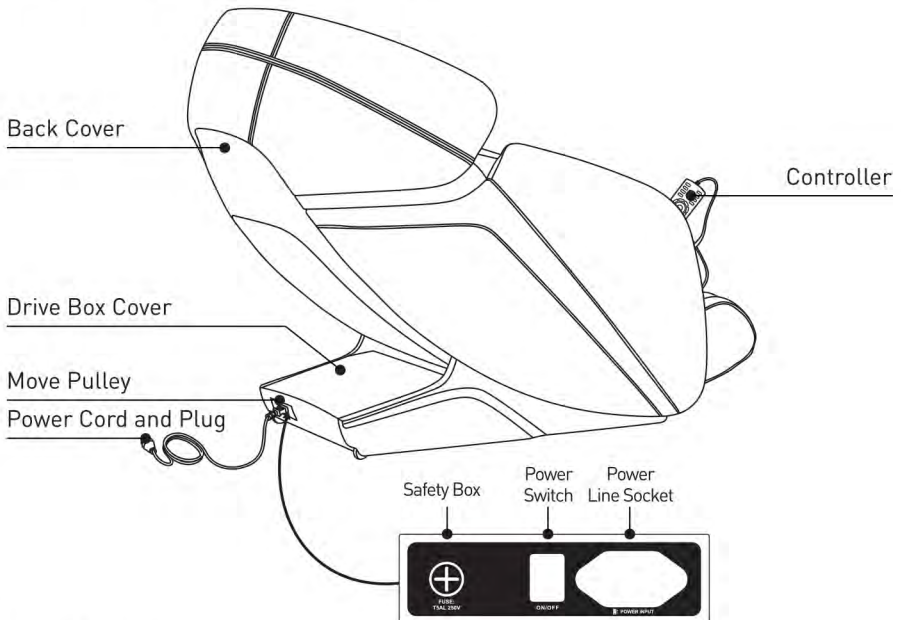

1. The calf installation

1. After connecting the air hose and the harness on the calf and the massage chair, untie the fixed line belt and insert the connecting part into the frame. (Figure 1)
2. Place the calf fixing block on the two sides of the round tubes of the calf. (Figure 2)

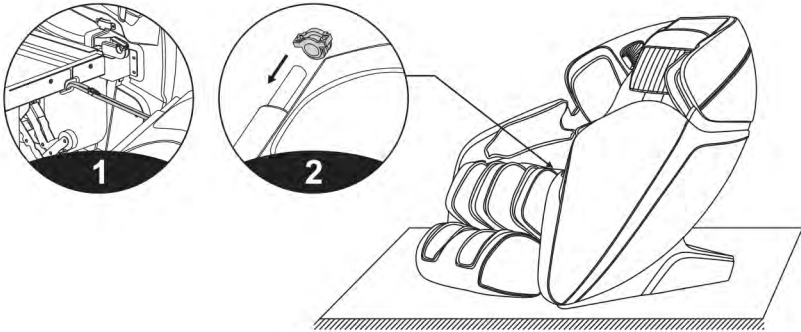

3. Hang the calf of the fixed block on the massage chair frame hook. (Figure 3)
4. Then use 4 (each side two pcs) M4 screws to fasten the calf to the massage chair, check whether there is any abnormality, whether the pipeline is folded or not, and finish the installation. (Figure 4)

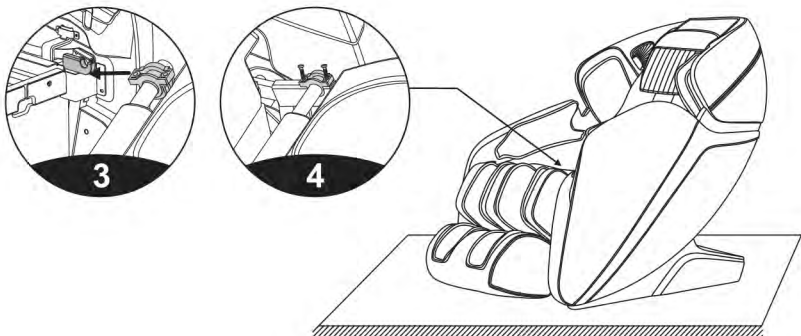

CHAIR INSTALLATION

| 2. Head cushion and backrest |

*The head cushion allows you to control the intensity of the neck and shoulder massage. You can decide whether to use the head cushion. (Recommend to use) The backrest cushion and the backrest is connected by zipper (1), head cushion and the backrest cushion connected by the massage chair as show in the illustration (2).

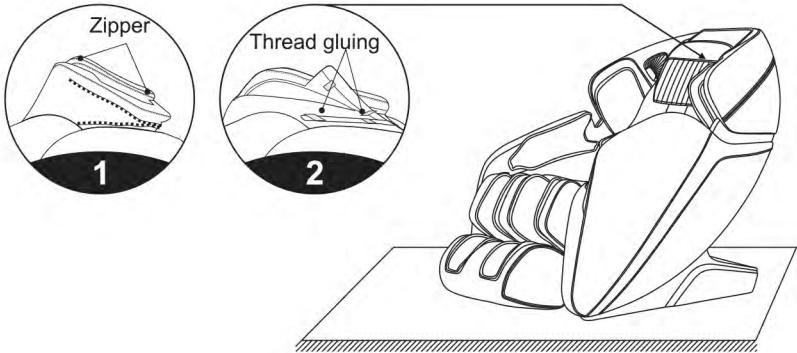

| 3. Floor protection |

*Put the heavy massage chairs on the wood floor for a may damage the floor, so please place a carpet or other object to avoid this damage.

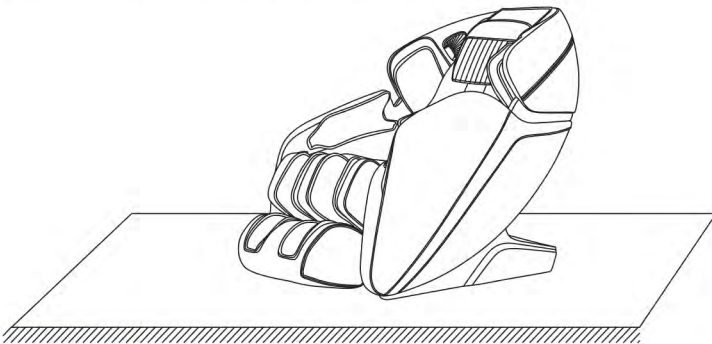

CAUTION

Do not move the chairs with its wheels on wood floor, rough ground or in a narrow space. Two people are required to lift the chair. During the lifting period, take the calf rest end sealing plate and backrest cover grooves as the force-bearing point(Please do not lift armrest directly.)

| 4. Moving the massage chair |

After completing the installation, put the chair in incline / upright position to move the chair easily.

- As illustrated, tilt the chair back onto it's wheels at 45° angle. Slowly push and maneuver the massage chair to desired location. Lower massage chair slowly and smoothly until it is fully flat on the ground.

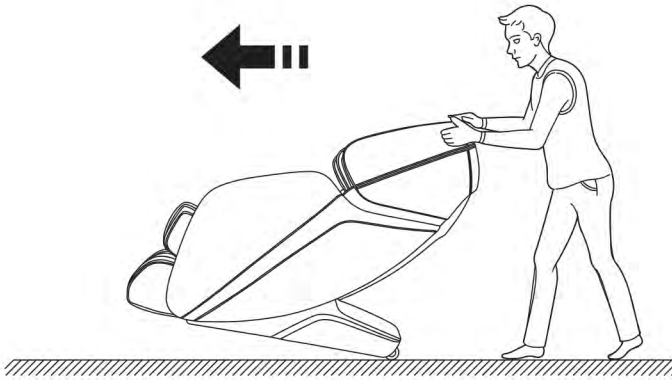

| 5. Place the massage chair in an open area |

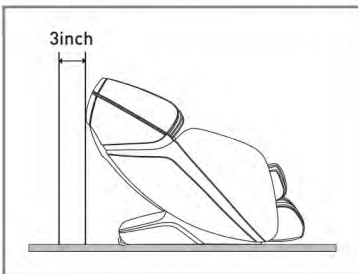

- Allow sufficient space around the chair for recline purposes.
- 3 inch distance for the back side and 19.7 inch in front of the foot rest.

REMOTE CONTROLLER

| Remote Controller |

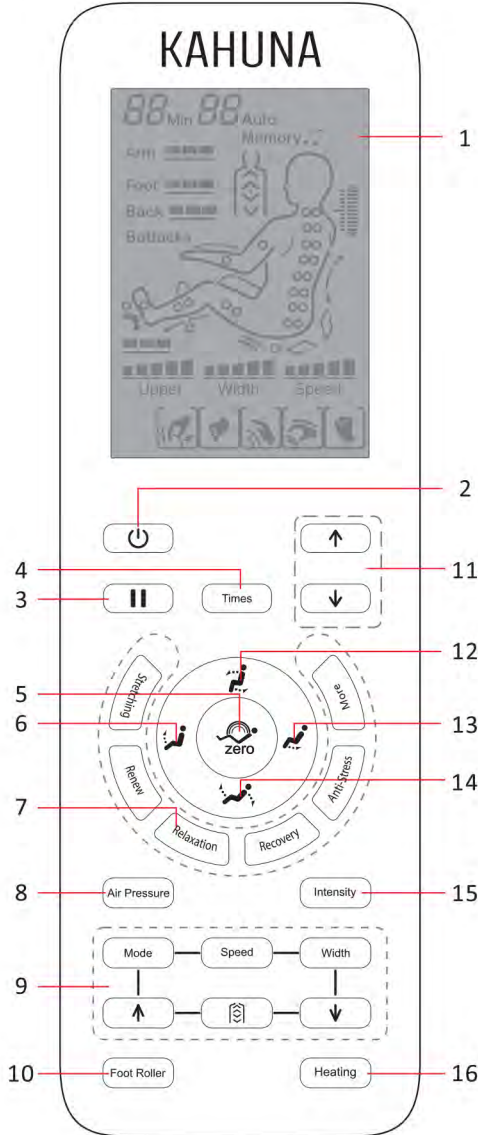

1. LCD
2. On/Off Massage chair
3. Pause/Emergency stop
4. Time control button
5. Automatic reclining
6. Footrest up button
7. Automatic massage button
8. Air pressure mode button
9. Manual massage type
10. Foot roller button
11. Shoulder adjustment button
12. Up button
13. Calf frame down button
14. Lie down button
15. Air pressure intensity button
16. Heating

1. Switch power supply on

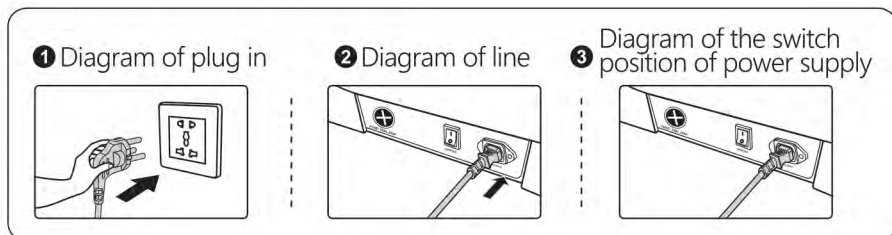

2. Start to massage

1. Press power button to start massage, start comfort auto massage by default.
2. The massage chair automatically recline.
3. Automatic shoulder position detection, make sure sit on massage chair closely.
4. If the detected shoulder position deviates from the actual position, you can adjust the up and down button to a suitable position. The shoulder position has 10 level adjustable. If there is no shoulder position adjustment within 10 seconds, the massage function will start automatically.

Note: In the progress of start massage function, you can select the auto massage function. Repeat select the same auto massage function, can skip the detection process and directly enter the massage.

Button	Description	Display
	Move the massage balls upward to a suitable position	
	Move the massage balls downward to a suitable position	

During the detection of shoulder massage and acupressure point process, (the hand controller screen has the shoulder position adjustment icon and the sound "Di, Di" can be heard from the hand controller, then press the shoulder position up and down button to adjust the shoulder position.) You can also choose any 12 kinds of automatic massage to enter the massage function. (Can skip 4rd step directly).

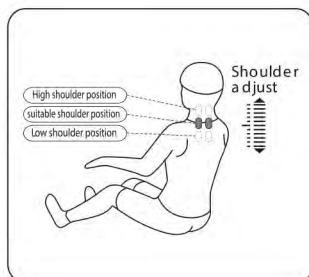











OPERATION GUIDE







Automatic massage

Function	Button	Description	Display
Automatic massage		Inspired by Yoga and program targeted to stretch your body. Perfect program to use daily for tired body.	F1 Auto
		Moderate massage with knead, tap, and roll techniques from neck to glutes to recharge your body.	F2 Auto
		Daily use program with combination of gentle roller and light air-cell massage system to promote relaxation and soothes body.	F3 Auto
		Recovery massage program that performs slow light massage for after workout.	F4 Auto
		Strong upper neck and shoulder care massage program with full motion that starts with shoulder to head air-cell massage to blow away your tension.	F5 Auto
		Strong Deep massage to rejuvenate the body.	A1 Auto
		Focus on chiropractic massage, relax body and mind.	A2 Auto
		Through the twelve major health acupoints massage to help the body recuperate balance, quickly improve sleep and quality.	A3 Auto
		Full air pressure focusing on the upper-body pressure massage to fully relax the body.	A4 Auto
		Full air pressure focusing on the lower-body pressure massage to fully relax the body.	A5 Auto
		Aimed at buttock and thigh effective massage, beautify body shape reduce the accumulation of redundant adipose body.	A6 Auto
		Chiropractic massage, during stretch helps more blood circulation and help aligns your spine.	A7 Auto

| Upper body manual massage |

Function	Button	Massage ball adjustment		Display
Technique	Mode	Shiatsu	speed, width	
		Knead	speed	
		Tapping	speed, width	
		Knead + Tapping	speed	
		Knock	speed, width	
Speed	Speed	5 speed level		
Width	Width	The width of the third gear can be adjusted		
Back Stretch	Fixed Spot	Fixed spot massage		
		Partial massage		
		Full body massage		
	Up	Massage position can be adjusted In fixed position.		Manipulator uplink
	Down			Manipulator descending

| Pneumatic massage |



Function	Button	Description	Display
Air Pressure Mode	Air Pressure	Full pressure:Air pressure massage on arms legs and feet.	Arm  Feet 
		Arm:Air pressure massage with the arm as the focus.	Arm 
		Leg:Barometric massage gor lrg, foot.	Feet 
Intensity	Intensity	5 intensity level	Arm  Feet 

| Foot roller massage |



Function	Button	Description	Display
Foot Roller	Foot Roller	Press this button to turn on or off the foot roller massage, and has a weak, medium, strong three levels of intensity can be adjusted to close the four states of cycle switching.	

OPERATION GUIDE





| Heated massage |

Function	Button	Description	Display
Heat		Press this button to turn on or off the back far infrared hyperthermia. Turn on 3 minutes later have a warm.	



| Pause/start massage button |

Function	Button	Description	Display
Pause /Start		Press this button in the process of massage, and all massage movements will be suspended urgently when time continues to countdown), and then press this key to resume all before suspension massage.	

| Seating position |

Function	Button	Description
Set up		Press this button, backrest frame slowly rise, calf frame slowly fall, and issued "di...di..."until it reached the top. Press this button again in the process of sitting, them stop sitting immediately.
Lay Down Key		Press this key, backrest frame slowly down, calf frame slowly up, and issued "di...di..."until it stops. Press this key again in lying down process, stop lying down immediately.
Calf Rise up		Press and hold this button, the calf frame slowly rises, and issue "di...di..."until it reaches the top and stops. Release it and stop adjusting.
Calf Go Down		Press this button, lower leg frame slowly, and issue "di...Di..."until the end of the stop, release will stop adjustment.
Lie Down Automatically		Press the button every time to switch one automatic lying mode. There are three modes in total.

| Other manual functions |





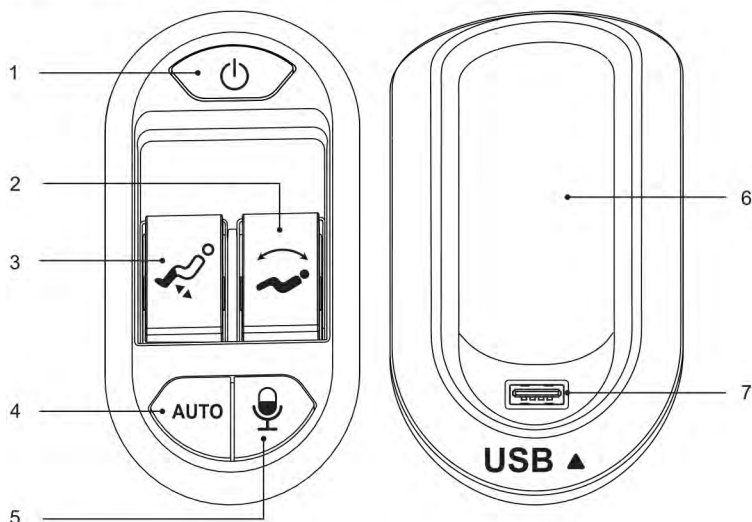

Function	Button	Description	Display
Timimg		Time adjustment, every time to press will add 5 minutes, can not exceed 30 minutes, if more than 30 minutes return to the minimum time value.	

| 3.Introduction of handrail shortcut keys |

The left arm

The right arm



Function	Description
 Power	Press this button to turn the massage function on or off.
 Calf frame lifting	Hold the button up to raise the calf frame slowly, and release it to stop the calf frame from rising.
 Linkage adjustment	Press and hold the button down slowly to lower the calf frame, and release to stop the lower leg frame.
 Linkage adjustment	Hold the button up the back frame slowly, while the calf frame slowly descends, release the backrest frame and the calf frame are stopped.
 Linkage adjustment	Hold the button down slowly to lower the backrest frame, while the calf frame rises slowly, releasing then the backrest frame and the calf frame are stopped.
AUTO	Each time you press it, the auto massage function switches.
 Voice	Press this button to wake up the voice control function.
 USB jack	USB charging port, you can charge smart devices(such as mobile phones).

4.Voice control operation

*When the massage chair is open or in stand by mode, say "Activate Kahuna" or press the voice control wake-up button on the right armrest to wake up the voice control function.

*After the successful wake-up, the massage chair will reply "On". At this time, the voice control entry corresponding to the function is realized within 6 seconds. After the massage chair is respond, the corresponding voice control function can be realized;if did not correctly say any voice entry for more than 6 seconds, the voice control function automatically turns off and needs to be reawakened.

Voice control enter		
Awakening words-"Active Kahuna" Answer – On		
Serial No	Voice control entry	Answer entry
1	Start Kneading	Kneading on
2	Start Shiatsu	Shiatsu on
3	Start Tapping	Tapping on
4	Start Knocking	Knocking on
5	Start Combination	Tapping and knocking on
6	Area Full	Full Area massage
7	Area Partial	Partial Area massage
8	Area fixed	Fixed Area massage
9	Roller speed up	Speed up

Voice control enter		
Awakening words-“Active Kahuna” Answer – On		
Serial No	Voice control entry	Answer entry
10	Roller speed down	Speed down
11	Roller up	Position up
12	Roller up	Position down
13	Air Full	Full air massage
14	Air Arm	Arm air massage
15	Air Leg	Leg air massage
16	Air off	All air off
17	Air level up	Air intensity up
18	Air level down	Air intensity down
19	Foot on	Foot roller on
20	Foot off	Foot roller off

OPERATION GUIDE

| 3 After use |

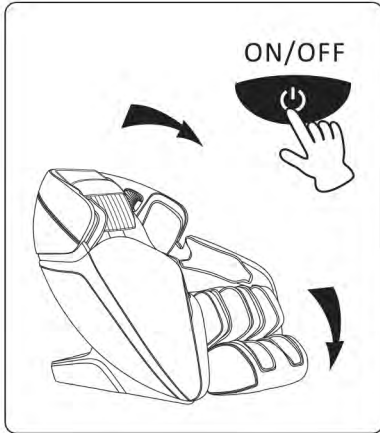

1. After the massage program is completed return the massage chair to upright position by turning off the massage chair.

Please check the surrounding prior to adjust the recline angle, paying special attention to children or pets that may be in close proximity.

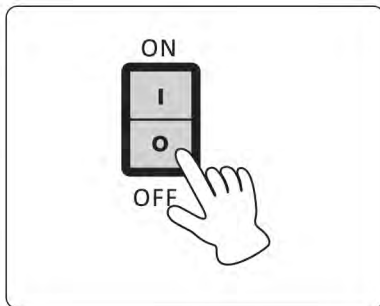

2. Press the power button to power off the massage chair and return remote controller to the storage area on arm pocket.

3. Turn off main power switch when you are not using the chair for a long period of time. Remove Plug from the power outlet to avoid accidents by kids and pets.

4. Do not operate with wet hands.

TROUBLE SHOOTING

If the sounds or movements are not normal, please turn off the massage chair and remove the plug from the electric outlet. Please contact the customer service department for further assistance.

855.646.9500 / 1.714.388.2625, service@kahunachair.com

Problem	Solution
The massage chair is connected to power but is not functioning.	Check to see if the power plug is inserted or if the power outlet is functioning properly.
The remote controller is responding, but the massage chair is not functioning.	The massage chair may have automatically shut down due to overheating protection devices. Please turn off the power and allow the chair to cool off for 30 to 50 minutes.
Both the remote controller and massage chair are not responding.	The massage chair automatically turns into "full stop" mode when a massage program is completed. Please press the power button again to turn of the chair.



KAHUNA CHAIR PRODUCT WARRANTY REGISTRATION
<https://www.kahunachair.com/services/>

MAINTENANCE

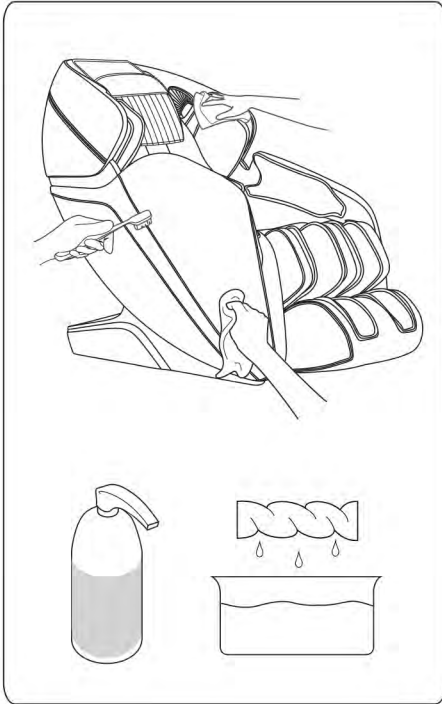

| Use dry cloth to clean |

Turn off and pull out the plug before cleaning the massage chair, do not touch the plug with wet hands.



Prohibit using liquid cleaning products like water, alcohol, or other cleaning product to maintain a good quality.

PRODUCT SPECIFICATIONS

Description	Specifications
Product Name	Kahuna Massage Chair
Model No.	LM 7000
Rated Voltage	110-120V~
Rated Frequency	50/60Hz
Rated Power Consumption	120 W
Dimension (LxWxH) Inches	70.87 x 30.32 x 33.46 inches
Weight (LBS)	Net Weight: 198.42 lbs Gross Weight :227.07lbs



Product KAHUNA Massage Chair

Model LM 7000

Distributed by AJX Distribution INC

11125 Knott Ave, Suite D

Cypress, CA 90630

Tel 1-855-646-9500

Email INFO@KAHUNACHAIR.COM

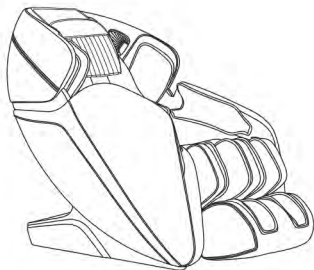

You must register warranty at www.kahunachair.com/services/

INSTRUCTION MANUAL
MODEL : LM 7000

Please read this user manual thoroughly
prior to operating the massage chair.
Store this booklet for future reference.