

motiv

ELECTRIC BICYCLES

Owner's Manual

Must Read

Bicycle Owner's Manual

IMPORTANT:

This manual contains important safety, performance and service information. Read it before you take the first ride on your new electric bicycle, and keep it for reference.

Additional safety, performance and service information for specific components such as batteries or pedals on your bicycle, or for accessories such as helmets or lights that you purchase, may also be available. Make sure that you have been given all the manufacturers' literature that was included with your bicycle or accessories. In case of a conflict between the instructions in this manual and information provided by a component manufacturer, always follow the component manufacturer's instructions. If you have any questions or do not understand something, take responsibility for your safety and consult with your dealer or the bicycle's manufacturer.

NOTE:

This manual is not intended as a comprehensive use, service, repair or maintenance manual. Please see your dealer or call the manufacturer for all service, repairs, or maintenance. Your dealer may also be able to refer you to classes, clinics or books on bicycle use, service, repair or maintenance.

PRODUCT REGISTRATION:

In order to improve warranty service you must completely fill out the online Bicycle Registration at time of purchase. This can be found at: www.motiveelectricbikes.com/registration. To see Motiv's current limited warranty and related warranty claims information please visit: www.motiveelectricbikes.com/warranty Outside the USA and Canada the WARRANTY REGISTRATION CARD included in the back of this Owners Manual must be filled out immediately and returned to Motiv Electric Bikes.

CONGRATULATIONS!

You've just bought one of the finest electric bicycles in the world; a Motiv! We developed and refined the quality that an electric bicycle should be and presented it to you. We work with top name suppliers to identify the best new materials and latest developments in our technology.

We ride Motiv bicycles every day to evaluate and improve our products. The result is a durable, stylish, high performance electric bicycle that we're sure you will be proud to own and ride for many years to come

We are extremely proud of the products we offer, and the service offered by our staff and our distributors. We are certain that our commitment to excellence will be evident every time you go for a ride. So here's wishing you many hours of fun and enjoyment!

Thanks for investing in a MOTIV,

-the motiv team

Table of Contents

Chapter 1: Before You Ride

A. Bike Fit.....	9
B. Safety First.....	9
C. Mechanical and Electric Safety Check.....	10
D. First Ride.....	12

Chapter 2: Safety

A. The Basics	12
B. Riding Safety.....	13
C. Off Road Safety.....	15
D. Wet Weather Riding.....	16
E. Night Riding.....	16
F. Changing Components or Adding Accessories.....	18

Chapter 3: Maintenance Information

A. Wheels.....	18
1. Removing a disk brake - Front Wheel.....	19
2. Installing a disk brake - Front Wheel.....	19
3. Removing the rear disc brake.....	20
4. Installing a rear disc brake.....	21
B. Seat Post Cam Action Clamp.....	21
C. Brakes.....	22
D. Shifting Gears.....	23
E. Pedals.....	24
F. Tires and Tubes.....	24
G. Battery.....	27

H. Charger.....	28
I. Charging the Battery.....	28
J. Motor.....	29

Chapter 4: Bike Computer

A. Functions.....	29
B. Display.....	29
C. Button Definition.....	30
D. Set Up	30
E. Operation.....	32

Chapter 5: Service

A. Service Intervals.....	37
B. If Your Bicycle Sustains an Impact.....	38

Chapter 6: Folding Bike

A. Folding Directions.....	39
----------------------------	----

Appendix A: Lifespan of Your Bike and its Components

A. Nothing Lasts Forever.....	40
B. Perspective.....	40
C. Understanding Metals.....	41
B. Things to look for.....	43

Warranty Registration Card

Warranty Registration Card.....	45
---------------------------------	----

GENERAL WARNING:

Like any sport, bicycling involves risk of injury and damage. By choosing to ride an electric bicycle, you assume the responsibility for that risk, so you need to know — and to practice — the rules of safe and responsible riding and of proper use and maintenance. Proper use and maintenance of your electric bicycle reduces risk of injury. This Manual contains many “Warnings” and “Cautions” concerning the consequences of failure to maintain or inspect your bicycle and of failure to follow safe cycling practices.

•The combination of the safety alert symbol  and the word **WARNING** indicates a potentially hazardous situation which, if not avoided, could result in serious injury or death.

•The combination of the safety alert symbol  and the word **CAUTION** indicates a potentially hazardous situation which, if not avoided, may result in minor or moderate injury, or is an alert against unsafe practices.

•The word **CAUTION** used without the safety alert symbol indicates a situation which, if not avoided, could result in serious damage to the electric bicycle or the voiding of your warranty. Many of the Warnings and Cautions say “you may lose control and fall”. Because any fall can result in serious injury or even death, we do not always repeat the warning of possible injury or death. Because it is impossible to anticipate every situation or condition which can occur while riding, this Manual makes no representation about the safe use of the electric bicycle under all conditions. There are risks associated with the use of any electric bicycle which cannot be predicted or avoided, and which are the sole responsibility of the rider.



SPARK

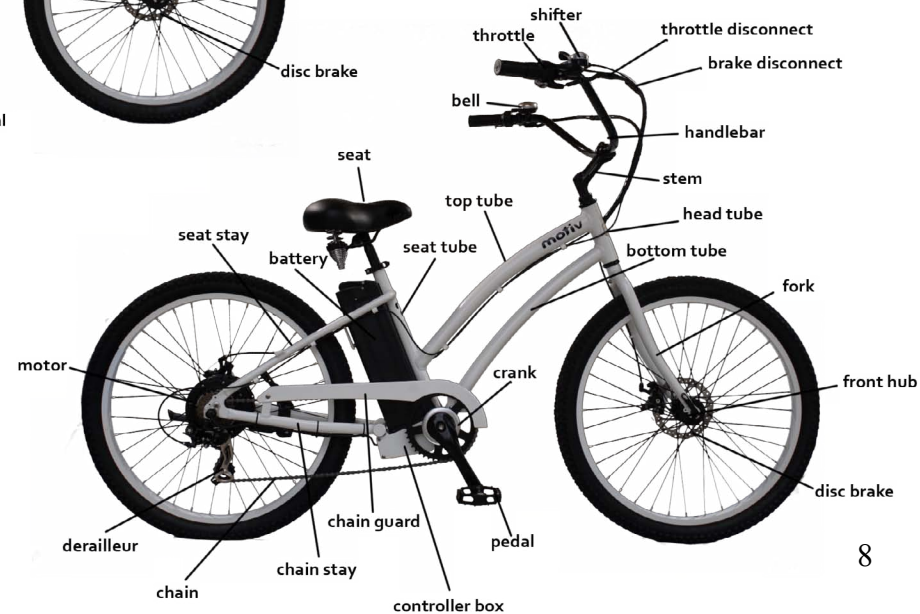

SLEEK

Chapter 1: Before You Ride

NOTE: We strongly urge you to read this Manual in its entirety before your first ride. At the very least, read and make sure that you understand each point in this section, and refer to the cited sections on any issue which you don't completely understand. Please note that not all bicycles have all of the features described in this Manual. Ask your dealer to point out the features of your bicycle.

A. Bike Fit

1. Is your bike the right size? If your bicycle is too large or too small for you, you may lose control and fall.
2. Is the seat at the right height?
3. Are seat and seat post securely clamped? A correctly tightened seat will allow no seat movement in any direction.
4. Are the stem and handlebars at the right height for you?
5. Can you comfortably operate the brakes? If not, you may be able to adjust their angle and reach. See Section 3C
6. Do you fully understand how to operate your new bicycle? If not, before your first ride, have your dealer explain any functions or features which you do not understand.

B. Safety First

1. Always wear an approved helmet when riding your bike, and follow the helmet manufacturer's instructions for fit, use and care.
2. Do you have all the other required and recommended safety equipment? See Section 2. It's your responsibility to familiarize yourself with the laws of the areas where you ride, and to comply with all applicable laws.
3. Do you know how to correctly secure your front and rear wheels? Check Section 3A to make sure. Riding with an improperly secured wheel can cause the wheel to wobble or disengage from the bicycle, and cause serious injury or death.

C. Mechanical and Electric Safety Check

Routinely check the condition of your electric bicycle before every ride. Nuts, bolts screws & other fasteners: you must use a torque wrench and the correct tightening torque specifications from the bicycle or component manufacturer or from your dealer. If you need to make an adjustment at home or in the field, we urge you to exercise care, and to have the fasteners you worked on checked by your dealer as soon as possible.

⚠️ WARNING: Correct tightening force on fasteners –nuts, bolts, screws– on your bicycle is important. Too little force, and the fastener may not hold securely. Too much force, and the fastener can strip threads, stretch, deform or break. Either way, incorrect tightening force can result in component failure, which can cause you to lose control and fall.

Make sure nothing is loose. Lift the front wheel off the ground by two or three inches, then let it bounce on the ground. Anything sound, feel or look loose? Do a visual and tactile inspection of the whole bike. Any loose parts or accessories? If so, secure them. If you're not sure, ask someone with experience to check.

Tires & Wheels: Make sure tires are correctly inflated (Section 3.G). Check by putting one hand on the saddle, one on the intersection of the handlebars and stem, then bouncing your weight on the bike while looking at tire deflection. Compare what you see with how it looks when you know the tires are correctly inflated; and adjust if necessary. Tires in good shape? Spin each wheel slowly and look for cuts in the tread and sidewall. Replace damaged tires before riding the bike. Wheels true? Spin each wheel and check for wheel wobble, side to side even slightly, take the bike to a qualified bike shop to have the wheel trued.

Brakes: Check the brakes for proper operation (Section 3.C). Squeeze the brake levers. All control cables seated and securely engaged? Can you apply full braking force at the levers without having them touch the handlebar? If not, your brakes need adjustment. Squeeze the levers again, and twist the throttle at the same time, does the motor engage? If so, the inhibitors are not working correctly. Do not ride the bike until the brakes are properly adjusted by a professional bicycle mechanic.

Wheel retention system: Make sure the front and rear wheels are correctly secured. (Section 3.A)

Seat post: If your seat post has an over-center cam action fastener for easy height adjustment, check that it is properly adjusted and in the locked position. (Section 3.B).

Handlebar and saddle alignment: Make sure the saddle and handlebar stem are parallel to the bike's center line and clamped tight enough so that you can't twist them out of alignment.

Battery Check: The battery is located behind the seat tube and underneath the seat. Make sure the battery turns on. Turn the key counter-clock wise until you hear a click and the key stops turning. Check throttle lights to see if they are lit. If they are not, press the red button beneath the lights to activate the system. If there is no response double check the cables, then contact the distributor if the problem is not resolved.



Throttle: Make sure the lights turn on and off by pressing the red button. With the lights on, twist the rubber part of the throttle towards you without squeezing the brake levers. Does the motor engage? If not, contact the distributor.



Lights "OFF"



Lights "ON"

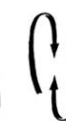

Twist towards body

CAUTION: Become familiar with the controls and how the bike operates before engaging the motor

D. First Ride

When you buckle on your helmet and go for your first familiarization ride on your new electric bicycle, be sure to pick a controlled environment, away from cars, other cyclists, obstacles or other hazards. Ride to become familiar with the controls, features and performance of your new bike. Familiarize yourself with the braking action of the bike (see Section 4.C). Test the brakes at slow speed, putting your weight toward the rear and gently applying the brakes, rear brake first. Sudden or excessive application of the front brake could pitch you over the handlebars. Applying brakes too hard can lock up a wheel, which could cause you to lose control and fall. Skidding is an example of what can happen when a wheel locks up.

Practice shifting the gears (see Section 3.D). Remember to never move the shifter while pedaling backward, nor pedal backwards immediately after having moved the shifter. This could jam the chain and cause serious damage to the electric bicycle. Check out the handling and response of the bike; and check the comfort. If you have any questions, or if you feel anything about the bike is not as it should be, consult your dealer before you ride again.

Chapter 2: Safety

A. The Basics

 **WARNING:** *The area in which you ride may require specific safety devices. It is your responsibility to familiarize yourself with the laws of the area where you ride and to comply with all applicable laws, including properly equipping yourself and your bike as the law requires. Observe all local bicycle laws and regulations. Observe regulations about bicycle lighting, licensing of bicycles, riding on side-walks, laws regulating bike path and trail use, helmet laws, child carrier laws, special bicycle traffic laws. It's your responsibility to know and obey the laws.*

1. Always wear a cycling helmet which meets the latest certification standards. Always follow the helmet manufacturer's instructions for fit, use and care of your helmet. Most serious bicycle injuries involve head injuries which might have been avoided if the rider had worn an appropriate helmet.

 **WARNING:** *Failure to wear a helmet when riding may result in serious injury or death.*

2. Always do the Mechanical Safety Check (Section 1.C) before you get on a bike.

3. Be thoroughly familiar with the controls of your bicycle: brakes (Section 3.A.); pedals (Section 3.E.); shifting (Section 3.D.); throttle (Section 3.G)

4. Be careful to keep body parts and other objects away from the sharp teeth of gears, the moving chain, the turning pedals and cranks, and the spinning wheels of your bicycle.

5. Always wear:

- Shoes that will stay on your feet and will grip the pedals. Make sure that shoe laces cannot get into moving parts, and never ride barefoot or in sandals.
- Bright, visible clothing that is not so loose that it can be tangled in the bicycle or snagged by objects at the side of the road or trail.
- Protective eyewear (to protect against airborne dirt, dust and bugs) tinted when the sun is bright, clear when it's not.

6. Don't jump or take any drops with your electric bike, it can put huge and unpredictable stress on the electric bicycle and its components. Riders who insist on jumping their bikes risk serious damage, to their electric bicycles as well as to themselves.

7. Ride at a speed appropriate for conditions. Higher speed means higher risk.

B. Riding Safety

1. Obey all Rules of the Road and all local traffic laws and never exceed 20 miles per hour while using the battery under load.

2. You are sharing the road or the path with others — motorists, pedestrians and other cyclists. Respect their rights.

3. Ride defensively. Always assume that others do not see you.

4. Look ahead, and be ready to avoid:

- Vehicles slowing or turning, entering the road or your lane ahead of you, or coming up behind you.
- Parked car doors opening.
- Pedestrians stepping out.
- Children or pets playing near the road.
- Pot holes, sewer grating, railroad tracks, expansion joints, road or sidewalk construction, debris and other obstructions that could cause you to swerve into traffic, catch your wheel or cause you to have an accident.
- The many other hazards and distractions which can occur on a bicycle ride.

5. Ride in designated bike lanes, on designated bike paths or as close to the edge of the road as possible, in the direction of traffic flow or as directed by local governing laws.

6. Stop at stop signs and traffic lights; slow down and look both ways at street intersections. Remember that a bicycle always loses in a collision with a motor vehicle, so be prepared to yield even if you have the right of way.

7. Use approved hand signals for turning and stopping.

8. Never ride with headphones. They mask traffic sounds and emergency vehicle sirens, distract you from concentrating on what's going on around you, and their wires can tangle in the moving parts of the bicycle, causing you to lose control.

9. Never carry a passenger, unless it is a small child wearing an approved helmet and secured in a correctly mounted child carrier or a child-carrying trailer.

10. Never carry anything which obstructs your vision or your complete control of the bicycle, or which could become entangled in the moving parts of the bicycle.

11. Never hitch a ride by holding on to another vehicle.

12. Don't do stunts, wheelies or jumps. If you intend to do stunts, wheelies or jumps, think carefully about your skills before deciding to take the large risks that go with this kind of riding.

13. Don't weave through traffic or make any moves that may surprise people with whom you are sharing the road.

14. Observe and yield the right of way.

15. Never ride your bicycle while under the influence of alcohol or drugs.

16. If possible, avoid riding in bad weather, when visibility is obscured, at dawn, dusk or in the dark, or when extremely tired. Each of these conditions increases the risk of accident.

C. Off Road Safety

Motiv does not recommend off road use but here are some tips to follow if you chose to do so.

1. The variable conditions and hazards of off-road riding require close attention and specific skills. Start slowly on easier terrain and build up your skills. If your bike has suspension, the increased speed you may develop also increases your risk of losing control and falling. Get to know how to handle your bike safely before trying increased speed or more difficult terrain.

2. Wear safety gear appropriate to the kind of riding you plan to do.

3. Don't ride alone in remote areas. Even when riding with others, make sure that someone knows where you're going and when you expect to be back.

4. Always take along some kind of identification, so that people know who you are in case of an accident; and take along some cash for food, a cool drink or an emergency phone call.

5. Yield right of way to pedestrians and animals. Ride in a way that does not frighten or endanger them, and give them enough room so that their unexpected moves don't endanger you.

6. Be prepared. If something goes wrong while you're riding off-road, help may not be close.

7. Before you attempt to jump, do stunt riding or race with your bike, read and understand Section 2.F.

Off Road respect

Obey the local laws regulating where and how you can ride off-road, and respect private property. You may be sharing the trail with others hikers, equestrians, other cyclists. Respect their rights. Stay on the designated trail. Don't contribute to erosion by riding in mud or with unnecessary sliding. Don't disturb the ecosystem by cutting your own trail or shortcut through vegetation or streams. It is your responsibility to minimize your impact on the environment. Leave things as you found them; and always take out everything you brought in.

D. Wet Weather Riding

 **WARNING:** *Electronic components may get damaged in wet conditions. Wet weather impairs traction, braking and visibility, both for the bicyclist and for other vehicles sharing the road. The risk of an accident is dramatically increased in wet conditions. Under wet conditions, the stopping power of your brakes (as well as the brakes of other vehicles sharing the road) is dramatically reduced and your tires don't grip nearly as well. This makes it harder to control speed and easier to lose control. To make sure that you can slow down and stop safely in wet conditions, ride more slowly and apply your brakes earlier and more gradually than you would under normal, dry conditions. See also Section 4.C.*

E. Night Riding

Riding an electric bicycle at night is much more dangerous than riding during the day. A bicyclist is very difficult for motorists and pedestrians to see. Therefore, adults who choose to accept the greatly increased risk of riding at dawn, at dusk or at night need to take extra care both riding and choosing specialized equipment which helps reduce that risk. Consult your dealer about night riding safety equipment.

 **WARNING:** *Reflectors are not a substitute for required lights. Riding at dawn, at dusk, at night or at other times of poor visibility without an adequate bicycle lighting system and without reflectors is dangerous and may result in serious injury or death.*

Bicycle reflectors are designed to pick up and reflect car lights and street lights in a way that may help you to be seen and recognized as a moving bicyclist.

 **CAUTION:** *Check reflectors and their mounting brackets regularly to make sure that they are clean, straight, unbroken and securely mounted. Have your dealer replace damaged reflectors and straighten or tighten any that are bent or loose*

If you choose to ride under conditions of poor visibility, check and be sure you comply with all local laws about night riding, and take the following strongly recommended additional precautions:

- Purchase and install battery or generator powered head and tail lights which meet all regulatory requirements and provide adequate visibility.
- Wear light colored, reflective clothing and accessories, such as a reflective vest, reflective arm and leg bands, reflective stripes on your helmet, flashing lights attached to your body and/or your bicycle ... any reflective device or light source that moves will help you get the attention of approaching motorists, pedestrians and other traffic.
- Make sure your clothing or anything you may be carrying on the bicycle does not obstruct a reflector or light.
- Make sure that your bicycle is equipped with correctly positioned and securely mounted reflectors.

While riding at dawn, at dusk or at night:

- Ride slowly.
- Avoid dark areas and areas of heavy or fast-moving traffic.
- Avoid road hazards.
- If possible, ride on familiar routes.

If riding in traffic:

- Be predictable. Ride so that drivers can see you and predict your movements.
- Be alert. Ride defensively and expect the unexpected.
- If you plan to ride in traffic often, ask your dealer about traffic safety classes or a good book on bicycle traffic safety.

F. Changing Components or Adding Accessories

There are many components and accessories available to enhance the comfort, performance and appearance of your electric bicycle. However, if you change components or add accessories, you do so at your own risk. The bicycle's manufacturer may not have tested that component or accessory for compatibility, reliability or safety on your bicycle. Before installing any component or accessory, including a different size tire, make sure that it is compatible with your bicycle by checking with your dealer. Be sure to read, understand and follow the instructions that accompany the products you purchase for your bicycle.

 **WARNING:** Failure to confirm compatibility, properly install, operate and maintain any component or accessory can result in serious injury or death.

 **WARNING:** Changing the components on your bike with other than genuine replacement parts may compromise the safety of your bicycle and may void the warranty. Check with your dealer before changing the components on your bike.

Chapter 3: Maintenance Information

It's important to your safety, performance and enjoyment to understand how things work on your bicycle. We urge you to ask your dealer how to do the things described in this section before you attempt them yourself, and that you have your dealer check your work before you ride the bike. If you have even the slightest doubt as to whether you understand something in this section of the Manual, talk to your dealer.

A. Wheels

Our bicycle wheels are designed to be removable for easier transportation and for repair of a tire puncture. In most cases, the wheel axles are inserted into slots, called "dropouts" in the fork and frame.

Our Wheels are secured in one of two ways:

- A hollow axle with a shaft ("skewer") running through it which has an adjustable tension nut on one end and an over-center cam on the other.

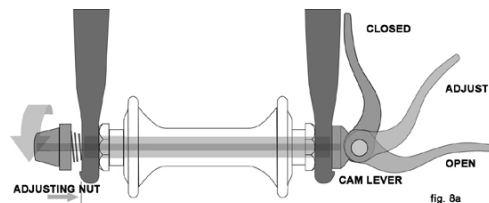

- Hex nuts or hex key bolts which are threaded on to or into the rear hub axle (bolt-on wheel, fig. 10)

1. Removing and Installing Wheels

 **CAUTION:** Exercise care in touching the rotor or caliper. Disc rotors have sharp edges, and both rotor and caliper can get very hot during use.

1. Removing a disk brake - Front Wheel

- (1) Move the adjusting nut, move the cam lever from the locked or CLOSED position to the OPEN position (fig. 8a).
- (2) You may need to tap the top of the wheel with the palm of your hand to release the wheel from the front fork.

2. Installing a disk brake - Front Wheel

 **CAUTION:** Your Electric bike is equipped with a front disk brake. Be careful not to damage the disk, caliper or brake pads when reinserting the disk into the caliper. Never activate a disk brake's control lever unless the disk is correctly inserted in the caliper.

- (1) With the steering fork facing forward, insert the wheel between the fork blades so that the axle seats firmly at the top of the fork dropouts. The cam lever should be on rider's left side of the bicycle (fig. 8a)
- (2) While pushing the wheel firmly to the top of the slots in the fork dropouts, and at the same time centering the wheel rim in the fork:
 - (a) With a cam action system, move the cam lever upwards and swing it into the CLOSED position (fig. 8a). The lever should now be parallel to the fork blade and curved toward the wheel. To apply enough clamping

force, you should have to wrap your fingers around the fork blade for leverage, and the lever should leave a clear imprint in the palm of your hand.

NOTE: If, on a traditional cam action system, the lever cannot be pushed all the way to a position parallel to the fork blade, return the lever to the OPEN position. Then turn the tension adjusting nut counterclockwise one quarter turn and try tightening the lever again.



WARNING: Securely clamping the wheel with a cam action retention device takes considerable force. If you can fully close the cam lever without wrapping your fingers around the fork blade for leverage, the lever does not leave a clear imprint in the palm of your hand, and the serrations on the wheel fastener do not emboss the surfaces of the dropouts, the tension is insufficient. Open the lever; turn the tension adjusting nut clockwise a quarter turn; then try again.

(7) Spin the wheel to make sure that it is centered in the frame and clears the brake pads; then squeeze the brake lever and make sure that the brakes are operating correctly.

3. Removing the rear disc brake

(1) Shift the rear derailleur to high gear (the smallest, outermost rear sprocket).

(2) Disconnect the motor from the main wiring harness

(3) Loosen the fasteners with a 19mm box wrench; then push the wheel forward far enough to be able to remove the chain from the rear sprocket.

(4) Lift the rear wheel off the ground a few inches and remove it from the rear dropouts.

4. Installing a rear disc brake

CAUTION: be careful not to damage the disk, caliper or brake pads when reinserting the disk into the caliper. Never activate a disk brake's control lever unless the disk is correctly inserted in the caliper

(1) Make sure that the rear derailleur is still in its outermost, high gear, position; then pull the derailleur body back with your right hand. Put the chain on top of the smallest freewheel sprocket.

(2) Then, insert the wheel into the frame dropouts and pull it all the way in to the dropouts.

(3) Center wheel in dropouts

(3) Tighten the 19mm fasteners.

(4) Reconnect motor wire

(5) Spin the wheel to make sure that it is centered in the frame and clears the brake pads; then squeeze the brake lever and make sure that the brakes are operating correctly.

B. Seat Post Cam Action Clamp

Our bikes are equipped with a cam action seat post binder. The seat post cam action binder works exactly like the traditional wheel cam action fastener



WARNING: Riding with an improperly tightened seat post can allow the saddle to turn or move and cause you to lose control and fall. Therefore:

1. Ask your dealer to help you make sure you know how to correctly clamp your seat post.

2. Understand and apply the correct technique for clamping your seat post.

3. Before you ride the bike, first check that the seat post is securely clamped.

Adjusting the seat post cam action mechanism The action of the cam squeezes the seat collar around the seat post to hold the seat post securely in place. The amount of clamping force is controlled by the tension adjusting nut. Turning the tension adjusting nut clockwise while keeping the cam lever from rotating increases clamping force; turning it counterclockwise while keeping the cam lever from rotating reduces clamping force. Less than half a turn of the tension adjusting nut can make the difference between safe and unsafe clamping force.

 **WARNING:** *The full force of the cam action is needed to clamp the seat post securely. Holding the nut with one hand or using a 5mm hex wrench and turning the lever like a wing nut with the other hand until everything is as tight as you can get it will not clamp the seat post safely.*

 **WARNING:** *If you can fully close the cam lever without wrapping your fingers around the seat post or a frame tube for leverage, and the lever does not leave a clear imprint in the palm of your hand, the tension is insufficient. Open the lever; turn the tension adjusting nut clockwise a quarter turn; then try again.*

C. Brakes

Our disc brakes, operate by squeezing a hub-mounted disc between two brake pads by way of a handlebar mounted lever.

 **WARNING**

1. *Riding with improperly adjusted brakes, worn brake pads, or wheels on which the rim wear mark is visible is dangerous and can result in serious injury or death.*

2. *Applying brakes too hard or too suddenly can lock up a wheel, which could cause you to lose control and fall. Sudden or excessive application of the front brake may pitch the rider over the handlebars, which may result in serious injury or death.*

3. *Disc brakes (fig. 11) are extremely powerful. Take extra care in becoming familiar with these brakes and exercise particular care when using them.*

4. *Disc brakes can get extremely hot with extended use. Be careful not to touch a disc brake until it has had plenty of time to cool.*

6. *See the brake manufacturer's instructions for operation and care of your brakes, and for when brake pads must be replaced. If you do not have the manufacturer's instructions, see your dealer or contact the brake manufacturer.*

7. *If replacing worn or damaged parts, use only manufacturer approved genuine replacement parts.*

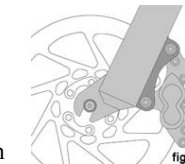

1. Brake controls and features

It's very important to your safety that you learn and remember which brake lever controls which brake on your bike. Traditionally, the right brake lever controls the rear brake and the left brake lever controls the front brake; but, to make sure your bike's brakes are set up this way, squeeze one brake lever and look to see which brake, front or rear, engages. Now do the same with the other brake lever. Make sure that your hands can reach and squeeze the brake levers comfortably. If your hands are too small to operate the levers comfortably, consult your dealer before riding the bike.

2. How brakes work

The braking action of an electric bicycle is a function of the friction between the braking surfaces. To make sure that you have maximum friction available, keep your brake pads, disk rotor, and caliper clean and free of dirt, lubricants, waxes or polishes.

Brakes are designed to control your speed, not just to stop the bike. Maximum braking force for each wheel occurs at the point just before the wheel "locks up" (stops rotating) and starts to skid. Once the tire skids, you actually lose most of your stopping force and all directional control. You need to practice slowing and stopping smoothly without locking up a wheel. The technique is called progressive brake modulation. Instead of jerking the brake lever to the position where you think you'll generate appropriate braking force, squeeze the lever, progressively increasing the braking force. If you feel the wheel begin to lock up, release pressure just a little to keep the wheel rotating just short of lockup. It's important to develop a feel for the amount of brake lever pressure required for each wheel at different speeds and on different surfaces. To better understand this, experiment a little by walking your bike and applying different amounts of pressure to each brake lever, until the wheel locks.

When you apply one or both brakes, the bike begins to slow, but your body wants to continue at the speed at which it was going. This causes a transfer of weight to the front wheel (or, under heavy braking, around the front wheel hub, which could send you flying over the handlebars) on different surfaces. To better understand this, experiment a little by walking your bike and applying different amounts of pressure to each brake lever, until the wheel locks.

D. Shifting Gears

Your electric bicycle has a derailleur drivetrain

1. How a derailleur drivetrain works

- a rear cassette
- a rear derailleur
- one shifter
- a drive chain

a. Shifting Gears

The vocabulary of shifting can be pretty confusing. A downshift is a shift to a “lower” or “slower” gear, one which is easier to pedal. An upshift is a shift to a “higher” or “faster”, harder to pedal gear. For example, you can select a gear which will make pedaling easier on a hill (make a downshift), the gear “steps” to a larger gear at the rear. Moving the chain out or away from the centerline of the bike is for speed and is called an upshift. Whether upshifting or downshifting, the bicycle derailleur system design requires that the drive chain be moving forward and be under at least some tension. A derailleur will shift only if you are pedaling forward.

 **CAUTION:** *Never move the shifter while pedaling backward, nor pedal backwards immediately after having moved the shifter. This could jam the chain and cause serious damage to the bicycle.*

b. Shifting the 6 speed Rear Derailleur

The rear derailleur is controlled by the right shifter. The function of the rear derailleur is to move the drive chain from one gear sprocket to another. The smaller sprockets on the gear cluster produce higher gear ratios. Pedaling in the higher gears requires greater pedaling effort, but takes you a greater distance with each revolution of the pedal cranks. The larger sprockets produce lower gear ratios. Using them requires less pedaling effort, but takes you a shorter distance with each pedal crank revolution. Moving the chain from a smaller sprocket of the gear cluster to a larger sprocket results in a downshift. Moving the chain from a larger sprocket to a smaller sprocket results in an upshift. In order for the derailleur to move the chain from one sprocket to another, the rider must be pedaling forward.

c. What if it won't shift gears?

If moving the shift control one click repeatedly fails to result in a smooth shift to the next gear chances are that the mechanism is out of adjustment. Take the bike to your dealer to have it adjusted.



E. Pedals

1. Toe Overlap is when your toe can touch the front wheel when you turn the handlebars to steer while a pedal is in the forward most position. This is common on small-framed bicycles, and is avoided by keeping the inside pedal up and the outside pedal down when making sharp turns. On any bicycle, this technique will also prevent the inside pedal from striking the ground in a turn.

 **WARNING:** *Toe Overlap could cause you to lose control and fall. Ask your dealer to help you determine if the combination of frame size, crank arm length, pedal design and shoes you will use results in pedal overlap. Whether you have overlap or not, you must keep the inside pedal up and the outside pedal down when making sharp turns.*

1. Our Electric bicycles come equipped with pedals that have sharp and potentially dangerous surfaces. These surfaces are designed to add safety by increasing grip between the rider's shoe and the pedal. You must take extra care to avoid serious injury from the pedals' sharp surfaces. Based on your riding style or skill level, you may prefer a less aggressive pedal design.

F. Tires and Tubes

1. Tires

Bicycle tires are available in many designs and specifications, ranging from general-purpose designs to tires designed to perform best under very specific weather or terrain conditions. If, once you've gained experience with your new bike, you feel that a different tire might better suit your riding needs, your dealer can help you select the most appropriate design. The size, pressure rating, and on some high-performance tires the specific recommended use, are marked on the sidewall of the tire. The part of this information which is most important to you is Tire Pressure

 **WARNING:** *Never inflate a tire beyond the maximum pressure marked on the tire's sidewall. Exceeding the recommended maximum pressure may blow the tire off the rim, which could cause damage to the bike and injury to the rider and bystanders.*

The best and safest way to inflate a bicycle tire to the correct pressure is with a bicycle pump which has a built-in pressure gauge.

Tire pressure is given either as maximum pressure or as a pressure range. How a tire performs under different terrain or weather conditions depends largely on tire pressure. Inflating the tire to near its maximum recommended pressure gives the lowest rolling resistance; but also produces the harshest ride and will give you more distance on a single battery charge.

High pressures work best on smooth, dry pavement. Very low pressures, at the bottom of the recommended pressure range, give the best performance on smooth, slick terrain and digresses range on a single charge. Tire pressure that is too low for your weight and the riding conditions can cause a puncture of the tube by allowing the tire to deform sufficiently to pinch the inner tube between the rim and the riding surface.

2. Tire Valves

There are primarily two kinds of bicycle tube valves: The Schraeder Valve and the Presta Valve. The bicycle pump you use must have the fitting appropriate to the valve stems on your bicycle. Our bikes come standard with a Schraeder Valve, but a Presta Valve can be used, but it isn't apt.

The Schraeder valve (fig. 18a) is like the valve on a car tire. To inflate a Schraeder valve tube, remove the valve cap and clamp the pump fitting onto the end of the valve stem. To let air out of a Schraeder valve, depress the pin in the end of the valve stem with the end of a key or other appropriate object.

The Presta valve (fig. 18b) has a narrower diameter and is only found on bicycle tires. To inflate a Presta valve tube using a Presta headed bicycle pump, remove the valve cap; unscrew (counterclockwise) the valve stem lock nut; and push down on the valve stem to free it up. Then push the pump head on to the valve head, and inflate. To inflate a Presta valve with a Schraeder pump fitting, you'll need a Presta adapter (available at your bike shop) which screws on to the valve stem once you've freed up the valve. The adapter fits into the Schraeder pump fitting. Close the valve after inflation. To let air out of a Presta valve, open up the valve stem lock nut and depress the valve stem.

 **WARNING:** We highly recommend that you carry a spare inner tube when you ride your bike. Patching a tube is an emergency repair. If you do not apply the patch correctly or apply several patches, the tube can fail, resulting in possible tube failure, which could cause you to lose control and fall. Replace a patched tube as soon as possible.

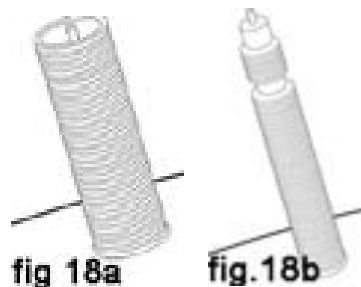

G. Battery

1. Our bike is powered by a Lithium Ion 36 volt or a Lithium Ion 48 volt battery, depending on the option taken at time of purchase. Age and use will cause the battery to slowly lose its capacity to hold a charge. If you find that your battery does not hold a sufficient charge after a short ride, contact your distributor for a replacement. Note: Do not dispose of a battery in the trash or in an incinerator. Refer to local authorities for directions on proper disposal or recycling.

Lithium Ion Polymer Batteries:

The battery's range depends on several factors, mainly, weight, terrain, and weather and to some extent, temperature. We calculated that the range is roughly 2 miles per amp hour (ah). We have 3 batteries that our customers can choose from depending on their preference and riding style.

Battery Type	Distance	Speed	Usage
36v 10ah	*20 miles	*17-20mph	Standard use for leisure riding
36v LR 15ah	*30 miles	*17-20mph	"Longer Range" battery for commuting or leisure riding
48v 10ah	*20 miles	**20-30mph	More power for hilly areas, or a personal preference

* Rider Weight, Rider Input and Terrain Contingent

** May exceed the federal speed limit of 20MPH

 **WARNING:** Never alter the battery or charger. Never place the battery near a fire, or leave it in direct sunlight for prolonged periods of time. Never immerse underwater or use corrosive substances near it.

 **Caution:** If you are planning on not using your Motiv for an extensive amount of time, fully charge your battery to its full capacity and store it in cool, dry place. Make sure you charge the battery to full capacity every 3 months to prolong its life. Improper use of the battery will damage the cells, void warranty, and may cause a fire or explosion.

H. Charger

1. The battery can be charged on or off the bike, and can easily be removed by removing the saddle and turning the key to the unlocked position and pulling up on the battery. Recharge the battery after every use. To charge the battery, plug the charger into an AC outlet. With remaining plug, insert that into the battery charger port. Charging can take 4 to 6 hours depending how depleted the battery is.



charger

I. Charging the Battery

To charge the battery, rotate the charge port cover to reveal the charge port, then connect the charging cable. Plug the charger into a 115 V outlet, and confirm that charging has started by checking to see that the red light on the charger is on. The charging process may take up to 6 hours, depending on the state of the battery. However, the charger will not overcharge the battery.

Recharge the battery before it completely runs out of power. This will reduce the number of recharges and capacity over the life of the battery. Never store the battery in discharged state.



charging door closed



charging door open



battery

J. Motor

The motor is a rear wheel 500 watt geared brushless motor available in a 36v or 48v system. We use a geared motor because it allows 80% more efficiency and running distance to the battery, which in turn, extends the life of the battery.

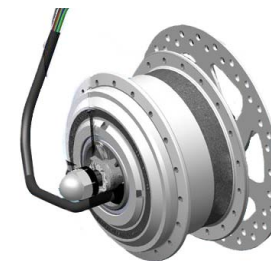

Chapter 4: Bike Computer

To ensure better performance of your e-bike, please read through the computer section carefully before using it. Here we will show you how to operate the settings and normal use of the display, it will also help you solve possible issues.

A. Functions

1. Wheel diameter 18-28inch
2. Max speed
3. LCD backlight contrast

B. Display

1. Battery capacity
2. Motor power
3. Riding speed,
4. Riding distance
5. Power
6. PUSH cruise control,
7. Error code display

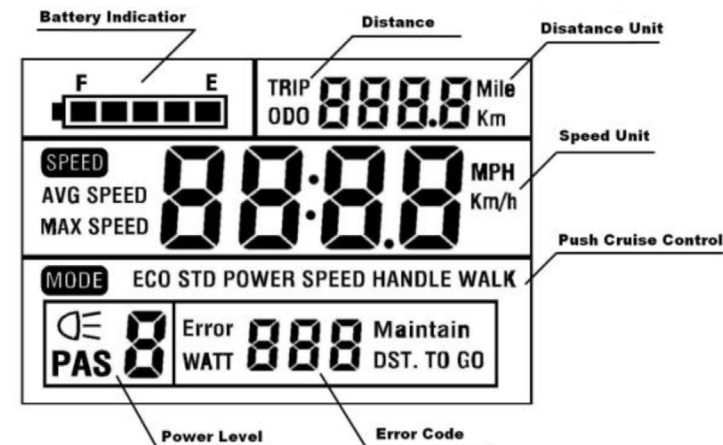

C. Button Definition

Equipped with special 30-button unit. This operating button is suit for both L/R hand, button instructions

1. In the following introduction, “MODE” is the button named MODE. “UP” is the button with the arrow facing up and “DOWN” is the button with the arrow pointed down.

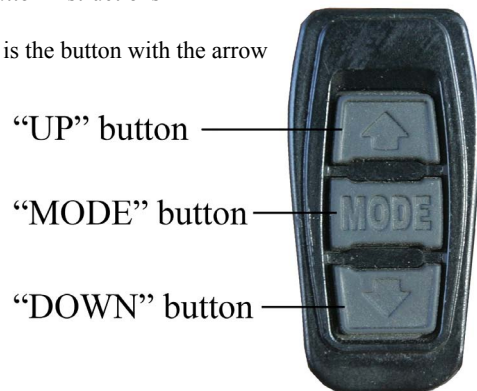

D. Set up

Make sure the wire is connect properly to the motor controller on the bike.

1. Turn on - Press the MODE button for 1.5 seconds and start the display.

2. Set up - Hold both UP and DOWN for 2.5 seconds at the same time, LCD will parameter will flash. The parameter can be set circularly.

a. Wheel Diameter

The first setting is wheel diameter. Press UP or DOWN to choose a right diameter 18-28inch. Press MODE to save the input. Next will be max speed.

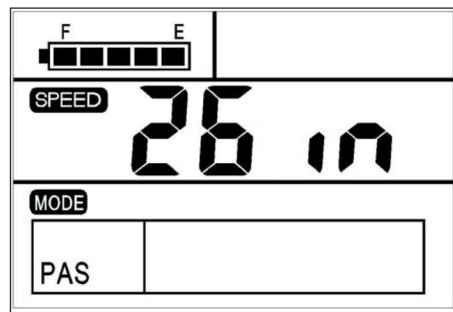

b. Max Speed

The second setting parameter is Max Speed. Re-set speed should be in accordance with the local regulation speed. If exceed your re-set figure, the bike will travel at the max speed of reset. Default max speed in factory is 25 Km/h. Speed option: 12-40Km/h, use UP or DOWN then confirm by MODE. Then enter into the interface of backlight brightness.

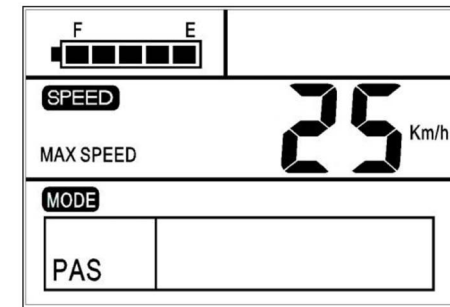

c. Backlight Brightness

The third setting parameter is backlight brightness. Press UP or DOWN to modify the backlight brightness. Choose from level 1 to level 3. Level 1 is the minimum brightness. Level 3 is the maximum brightness.

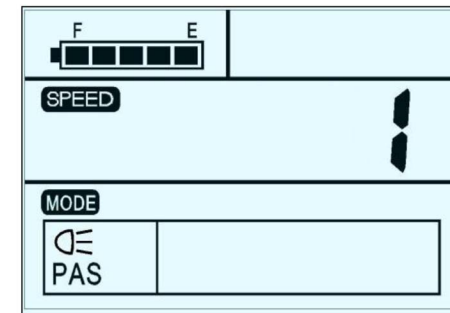

d. Choice of Display Unit (Metric system / British system)

Press UP or DOWN to choose a display unit. The unit could be MPH or Km/H. The range unit will change accordingly with the speed unit.

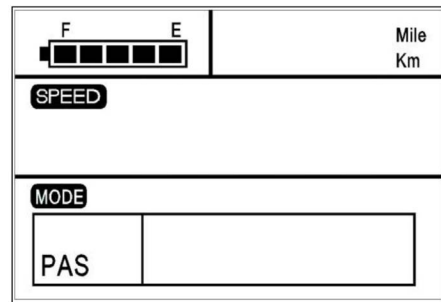

e. Quit from set up

In the setting state, press MODE for 3 seconds to confirm the input, save current setting and exit.

E. Standard Operation

1. ON / OFF

- a. To turn on press and hold MODE, and the display will turn on.
 - b. To turn off Press and hold MODE and the display will turn off
- When turned off the display and controller will not depeat the battery

2. Battery Capacity

When the battery capacity is full, the five battery segments will be lit up. When the battery has a low capacity the battery segment will flash. This indicates that the battery is severely low and needs to be recharged immediately.



3. Speed Display

Current Speed, Average Speed, and MaxSpeed. The display will automatically show the current speed. Hold UP and the display will show the MAX speed during the ride. Hold UP again and the display will show the AVG speed during the ride. Hold UP again and the display will turn to the current speed display.

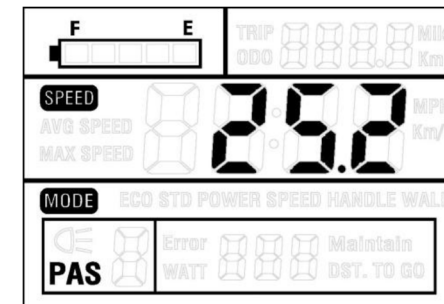

4. Assisted Power Select or Throttle Level Select

Press UP or DOWN to change the output power of the motor. The power ranges from Level 0 to Level 5. Level 1 is the minimum power. Level 0 is powerless and Level 5 is the maximum power.

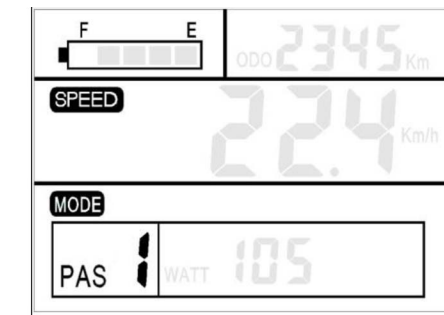

5. Distance Display

Riding Distance and Total Distance.

Press MODE to switch between riding distance and total distance. This function is convenient for users to check the riding distance (TRIP) and the total distance (ODO).

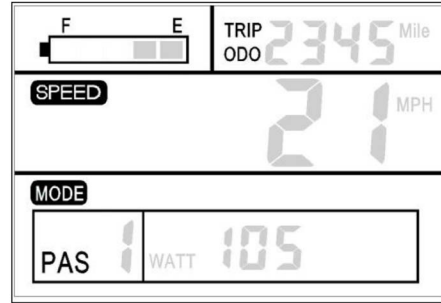

5. Backlight

Hold both UP and MODE for 3 seconds and the backlight will turn on. To turn it off Hold both UP and MODE for 3 seconds and the backlight will turn off. If your bike comes with a head light this will also turn the light on and off.

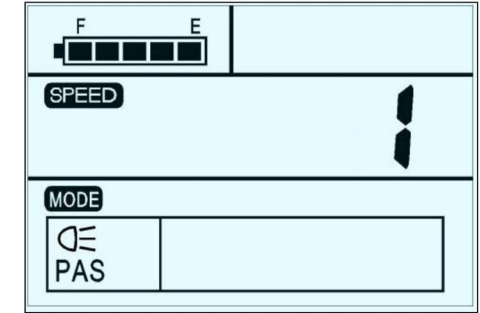

6. Push Cruise Control

Press DOWN and hold to get into power assist mode, and the bike will travel at fixed speed 6 kmh (3 mph).



WARNING: Push cruise control is only recommended for walking the bike, and not for riding.

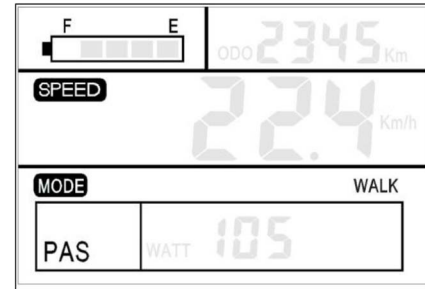

6. Error Code Display

Display return to normal only after problem being fixed and bike will not run before fixing the problem.

Code number Definition

- 21 Abnormal current
- 22 Throttle fault
- 23 Motor phase problem
- 24 Motor Hall defect
- 25 Brake Failed
- 30 Abnormal Communication

Chapter 5: Service

 **WARNING:** *Technological advances have made electric bicycles and bicycle components more complex, and the pace of innovation is increasing. It is impossible for this manual to provide all the information required to properly repair and/or maintain your electric bicycle. In order to help minimize the chances of an accident and possible injury, it is critical that you have any repair or maintenance which is not specifically described in this manual performed by your dealer. Equally important is that your individual maintenance requirements will be determined by everything from your riding style to geographic location. Consult your dealer for help in determining your maintenance requirements.*

 **WARNING:** *Many electric bicycle service and repair tasks require special knowledge and tools. Do not begin any adjustments or service on your electric bicycle until you have learned from your dealer how to properly complete them. Improper adjustment or service may result in damage to the electric bicycle or in an accident which can cause serious injury or death.*

If you want to learn to do major service and repair work on your bike:

1. Ask your dealer for copies of the manufacturer's installation and service instructions for the components on your bike, or contact the component manufacturer.
2. Ask your dealer to recommend a book on bicycle repair.
3. Ask your dealer about the availability of bicycle repair courses in your area.

We recommend that you ask your dealer to check the quality of your work the first time you work on something and before you ride the

bike, just to make sure that you did everything correctly. Since that will require the time of a mechanic, there may be a modest charge for this service. We also recommend that you ask your dealer for guidance on what spare parts, such as inner tubes, light bulbs, etc. it would be appropriate for you to have once you have learned how to replace such parts when they require replacement.

A. Service Intervals

Some service and maintenance can and should be performed by the owner, and require no special tools or knowledge beyond what is presented in this manual. The following are examples of the type of service you should perform yourself. All other service, maintenance and repair should be performed in a properly equipped facility by a qualified bicycle mechanic using the correct tools and procedures specified by the manufacturer.

1. Break-in Period: Your bike will last longer and work better if you break it in before riding it hard. Control cables and wheel spokes may stretch or "seat" when a new bike is first used and may require readjustment by your dealer. If you think something is wrong with the bike, take it to your dealer before riding it again.
2. Before every ride: Mechanical Safety Check (Section 1.C)
3. After every long ride: if the bike has been exposed to water or grit; or at least every 100 miles: Clean the bike and lightly lubricate the chain's rollers with a good quality bicycle chain lubricant. Wipe off excess lubricant with a lint-free cloth. Lubrication is a function of climate. Talk to your dealer about the best lubricants and the recommended lubrication frequency for your area.
4. After every long or hard ride or after every 10 to 20 hours of riding:
 - Squeeze the front brake and rock the bike forward and back. Everything feel solid? If you feel a clunk with each forward or backward movement of the bike, you probably have a loose headset. Have your dealer check it.
 - Lift the front wheel off the ground and swing it from side to side. Feel smooth? If you feel any binding or roughness in the steering, you may have a tight headset. Have your dealer check it.
 - Grab one pedal and rock it toward and away from the centerline of the bike; then do the same with the other pedal. Anything feel loose? If so, have your dealer check it.
 - Take a look at the brake pads. Starting to look worn or not hitting the wheel rim squarely? Time to have the dealer adjust or replace them.
 - Carefully check the control cables and cable housings. Any rust? Kinks? Fraying? If so, have your dealer replace them.

- Squeeze each adjoining pair of spokes on either side of each wheel between your thumb and index finger. Do they all feel about the same? If any feel loose, have your dealer check the wheel for tension and trueness.
- Check the tires for excess wear, cuts or bruises. Have your dealer replace them if necessary.
- Check the wheel rims for excess wear, dings, dents and scratches. Consult your dealer if you see any rim damage.
- Check to make sure that all parts and accessories are still secure, and tighten any which are not.
- Check the frame, particularly in the area around all tube joints; the handlebars; the stem; and the seatpost for any deep scratches, cracks or discoloration. These are signs of stress-caused fatigue and indicate that a part is at the end of its useful life and needs to be replaced

⚠ WARNING: Like any mechanical device, a bicycle and its components are subject to wear and stress. Different materials and mechanisms wear or fatigue from stress at different rates and have different life cycles. If a component's life cycle is exceeded, the component can suddenly and catastrophically fail, causing serious injury or death to the rider. Scratches, cracks, fraying and discoloration are signs of stress-caused fatigue and indicate that a part is at the end of its useful life and needs to be replaced. While the materials and workmanship of your bicycle or of individual components may be covered by a warranty for a specified period of time by the manufacturer, this is no guarantee that the product will last the term of the warranty. Product life is often related to the kind of riding you do and to the treatment to which you submit the bicycle. The bicycle's warranty is not meant to suggest that the bicycle cannot be broken or will last forever. It only means that the bicycle is covered subject to the terms of the warranty. Please be sure to read Appendix A, Intended Use of your bicycle and

5. As required: If either brake lever fails the Mechanical Safety Check (Section 1.C), don't ride the bike. Have your dealer check the brakes. If the chain won't shift smoothly and quietly from gear to gear, the derailleur is out of adjustment. See your dealer.

6. Every 25 to 50 hours of riding: Take your bike to your dealer for a complete checkup.

B. If Your Bicycle Sustains an Impact:

First, check yourself for injuries, and take care of them as best you can. Seek medical help if necessary.

Next, check your bike for damage

After any crash, take your bike to your dealer for a thorough check, including frames, wheels, handlebars, stems, cranksets, brakes, etc. which have sustained an impact must not be ridden until they have been disassembled and thoroughly inspected by a qualified mechanic.

Chapter 6: Folding Bike

Here we will show you how to operate the folding capabilities for the Stash Electric Bike

A. Folding Directions

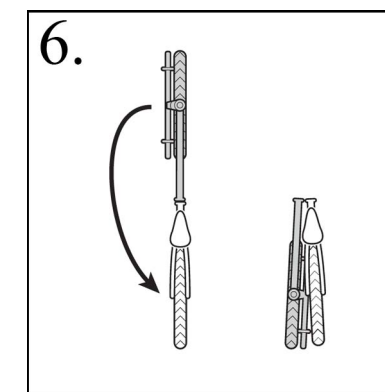
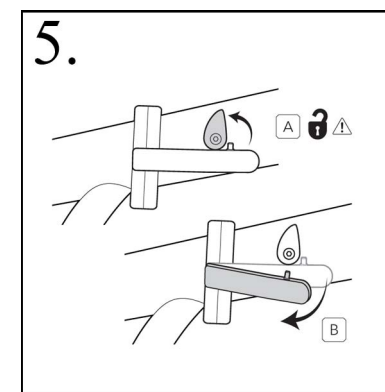
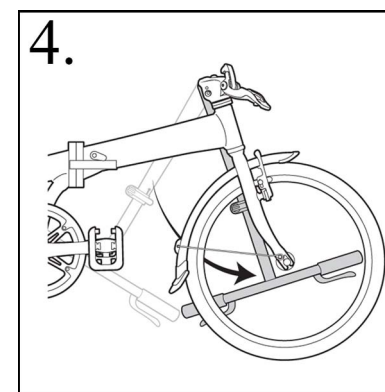
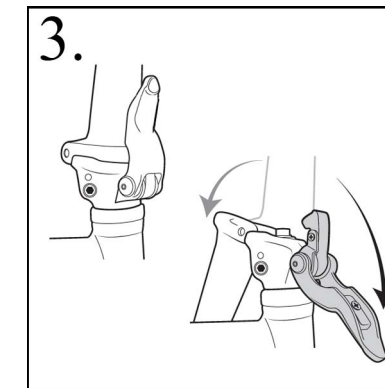
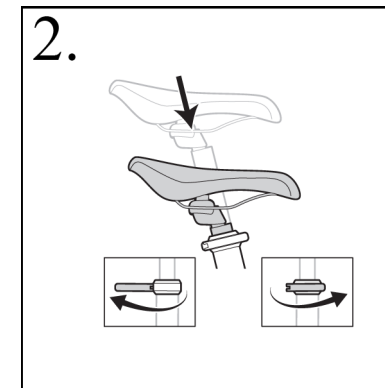
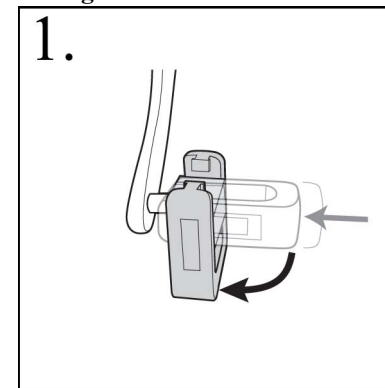

 **WARNING:** A crash or other impact can put extraordinary stress on bicycle components, causing them to fatigue prematurely. Components suffering from stress fatigue can fail suddenly and catastrophically, causing loss of control, serious injury or death.

Appendix A:

The lifespan of your bike and its components

A. Nothing Lasts Forever, Including Your Electric Bike.

When the useful life of your bike or its components is over, continued use is hazardous. Every bicycle and its component parts have a finite, limited useful life. The length of that life will vary with the construction and materials used in the frame and components; the maintenance and care the frame and components receive over their life; and the type and amount of use to which the frame and components are subjected. Use in competitive events, trick riding, ramp riding, jumping, aggressive riding, riding on severe terrain, riding in severe climates, riding with heavy loads, commercial activities and other types of non-standard use can dramatically shorten the life of the frame and components. Any one or a combination of these conditions may result in an unpredictable failure. All aspects of use being identical, lightweight bicycles and their components will usually have a shorter life than heavier bicycles and their components. In selecting a lightweight bicycle or components you are making a trade off, favoring the higher performance that comes with lighter weight over longevity. So, If you choose lightweight, high performance equipment, be sure to have it inspected frequently. You should have your electric bicycle and its components checked periodically by your dealer for indicators of stress and/or potential failure, including cracks, deformation, corrosion, paint peeling, dents, and any other indicators of potential problems, inappropriate use or abuse. These are important safety checks and very important to help prevent accidents, bodily injury to the rider and shortened product life.

B. Perspective

Today's electric bicycles require frequent and careful inspection and service. In this Appendix we try to explain some underlying material science basics and how they relate to your bicycle. We discuss some of the trade-offs made in designing your bicycle and what you can expect from your bicycle; and we provide important, basic guidelines on how to maintain and inspect it. We cannot teach you everything you need to know to properly inspect and service your bicycle; and that is why we repeatedly urge you to take your bicycle to your dealer for professional care and attention.

 **WARNING:** Frequent inspection of your bike is important to your safety. Follow the Mechanical Safety Check in Section 1.C of this Manual before every ride. Periodic, more detailed inspection of your bicycle is important. How often this more detailed inspection is

needed depends upon you. You, the rider/owner, have control and knowledge of how often you use your bike, how hard you use it and where you use it. Because your dealer cannot track your use, you must take responsibility for its maintenance and upkeep. Periodically bring in your bike to your dealer for inspection and service. Your dealer will help you decide what frequency of inspection and service is appropriate for how and where you use your bike. For your safety, understanding and communication with your dealer, we urge you to read this Appendix in its entirety. The materials used to make your bike determine how and how frequently to inspect. Ignoring this WARNING can lead to frame, fork or other component failure, which can result in serious injury or death.

C. Understanding Metals

Steel is the traditional material for building bicycle frames. It has good characteristics, but in high performance bicycles, steel has been largely replaced by aluminum and some titanium. The main factor driving this change is interest by cycling enthusiasts in lighter bicycles.

Properties of Metals

Please understand that there is no simple statement that can be made that characterizes the use of different metals for bicycles. What is true is how the metal chosen is applied is much more important than the material alone. One must look at the way the bike is designed, tested, manufactured, supported along with the characteristics of the metal rather than seeking a simplistic answer.

Metals vary widely in their resistance to corrosion. Steel must be protected or rust will attack it. Aluminum and Titanium quickly develop an oxide film that protects the metal from further corrosion. Both are therefore quite resistant to corrosion. Aluminum is not perfectly corrosion resistant, and particular care must be used where it contacts other metals and galvanic corrosion can occur. Metals are comparatively ductile. Ductile means bending, buckling and stretching before breaking. Generally speaking, of the common bicycle frame building materials steel is the most ductile, titanium less ductile, followed by aluminum. Metals vary in density. Density is weight per unit of material. Steel weighs 7.8 grams/cm³ (grams per cubic centimeter), titanium 4.5 grams/cm³, aluminum 2.75 grams/cm³. Contrast these numbers with carbon fiber composite at 1.45 grams/cm³. Metals are subject to fatigue. With enough cycles of use, at high enough loads, metals will eventually develop cracks that lead to failure. It is very important that you read The basics of metal fatigue below. Let's say you hit a curb, ditch, rock, car, another cyclist or other object. At any speed above a fast walk, your body will continue to move forward, momentum carrying you over the front of the bike. You cannot and will not stay on the bike, and what happens to the frame, fork and other components is irrelevant to what happens to your body. What should you expect from your metal frame? It depends on many complex factors, which is why we tell you that crash worthiness cannot be a design criteria. With that important note, we can tell you that if the impact is hard enough the fork or frame may be bent or buckled. On a steel bike, the steel fork may be severely bent and the frame undamaged. Aluminum is less ductile than steel, but you can expect the fork and frame to be bent or buckled. Hit harder and the top tube may be broken in tension and the

down tube buckled. Hit harder and the top tube may be broken, the down tube buckled and broken, leaving the head tube and fork separated from the main triangle. When a metal bike crashes, you will usually see some evidence of this ductility in bent, buckled or folded metal. It is now common for the main frame to be made of metal and the fork of carbon fiber. See Section B, Understanding composites below. The relative ductility of metals and the lack of ductility of carbon fiber means that in a crash scenario you can expect some bending or buckling in the metal but none in the carbon. Below some load the carbon fork may be intact even though the frame is damaged. Above some load the carbon fork will be completely broken.

The basics of metal fatigue

Common sense tells us that nothing that is used lasts forever. The more you use something, and the harder you use it, and the worse the conditions you use it in, the shorter its life. Fatigue is the term used to describe accumulated damage to a part caused by repeated loading. To cause fatigue damage, the load the part receives must be great enough. A crude, often-used example is bending a paper clip back and forth (repeated loading) until it breaks. This simple definition will help you understand that fatigue has nothing to do with time or age. A bicycle in a garage does not fatigue. Fatigue happens only through use. So what kind of “damage” are we talking about? On a microscopic level, a crack forms in a highly stressed area. As the load is repeatedly applied, the crack grows. At some point the crack becomes visible to the naked eye. Eventually it becomes so large that the part is too weak to carry the load that it could carry without the crack. At that point there can be a complete and immediate failure of the part. One can design a part that is so strong that fatigue life is nearly infinite. This requires a lot of material and a lot of weight. Any structure that must be light and strong will have a finite fatigue life. Aircraft, race cars, motorcycles all have parts with finite fatigue lives. If you wanted a bicycle with an infinite fatigue life, it would weigh far more than any bicycle sold today. So we all make a tradeoff: the wonderful, lightweight performance we want requires that we inspect the structure.

Things to look for:

• ONCE A CRACK STARTS IT CAN GROW AND GROW FAST.

Think about the crack as forming a pathway to failure. This means that any crack is potentially dangerous and will only become more dangerous.

SIMPLE RULE 1 : If you find crack, replace the part immediately.

• CORROSION SPEEDS DAMAGE.

Cracks grow more quickly when they are in a corrosive environment. Think about the corrosive solution as further weakening and extending the crack.

SIMPLE RULE 2 : Clean your bike, lubricate your bike, protect your bike from salt, remove any salt as soon as you can.

• STAINS AND DISCOLORATION CAN OCCUR NEAR A CRACK.

Such staining may be a warning sign that a crack exists.

SIMPLE RULE 3 : Inspect and investigate any staining to see if it is associated with a crack

• SIGNIFICANT SCRATCHES, GOUGES, DENTS OR SCORING CREATE STARTING POINTS FOR CRACKS.

Think about the cut surface as a focal point for stress (in fact engineers call such areas “stress risers,” areas where the stress is increased). Perhaps you have seen glass cut? Recall how the glass was scored and then broke on the scored line.

SIMPLE RULE 4 : Do not scratch, gouge or score any surface. If you do, pay frequent attention to this area or replace the part.

• SOME CRACKS (particularly larger ones) MAY MAKE CREAKING NOISES AS YOU RIDE.

Think about such a noise as a serious warning signal. Note that a well-maintained bicycle will be very quiet and free of creaks and squeaks.

SIMPLE RULE 5 : Investigate and find the source of any noise. It may not be a crack, but whatever is causing the noise should be fixed promptly.

In most cases a fatigue crack is not a defect. It is a sign that the part has been worn out, a sign the part has reached the end of its useful life. When your car tires wear down to the point that the tread bars are contacting the road, those tires are not defective. Those tires are worn out and the tread bar says “time for replacement.” When a metal part shows a fatigue crack, it is worn out. The crack says “time for replacement.”

Fatigue Is Not A Perfectly Predictable Science

Fatigue is not a perfectly predictable science, but here are some general factors to help you and your dealer determine how often your bicycle should be inspected. The more you fit the “shorten product life” profile, the more frequent your need to inspect. The more you fit the “lengthen product life” profile, the less frequent your need to inspect.

Factors that shorten product life:

- Hard, harsh riding style
- “Hits”, crashes, jumps, other “shots” to the bike
- High mileage
- Higher body weight
- Stronger, more fit, more aggressive rider
- Corrosive environment (wet, salt air, winter road salt, accumulated sweat)
- Presence of abrasive mud, dirt, sand, soil in riding environment

Factors that lengthen product life:

- Smooth, fluid riding style
- No “hits”, crashes, jumps, other “shots” to the bike
- Low mileage
- Lower body weight
- Less aggressive rider
- Non-corrosive environment (dry, salt-free air)
- Clean riding environment

WARRANTY REGISTRATION CARD

This WARRANTY REGISTRATION CARD must be filled out immediately and returned to Motiv

INSTRUCTIONS:

- Step 1) Please complete all information in this Warranty Registration Card.
- Step 2) Cut out this card from this Owner’s Manual.
- Step 3) Mail or Fax: Put in an envelope and mail to us or fax your Warranty Registration Card.

Name: _____

Address: _____

City: _____

Country: _____

Postal Code: _____

E-mail Address: _____

Bike Model: _____

Serial Number: _____

Place of Purchase: _____

Date of Purchase: _____

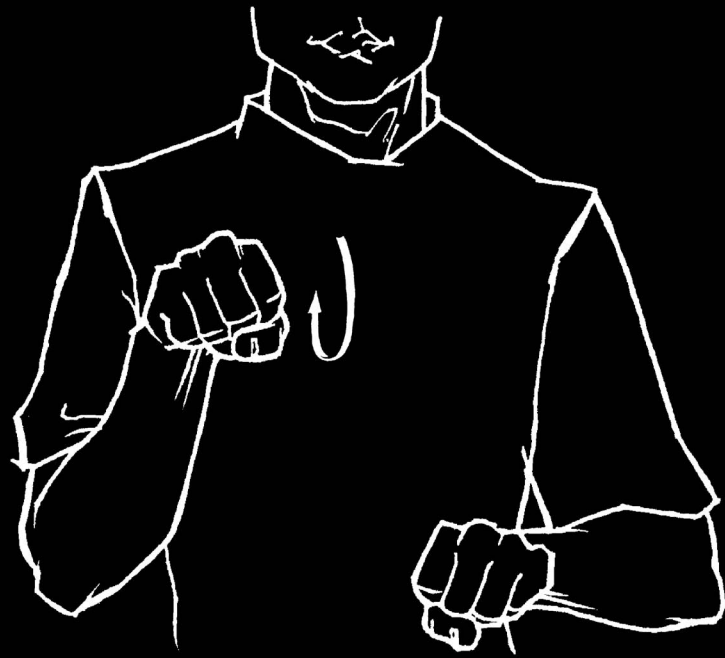

throttle