

# MIRROR IMAGE



FROM INSPIRATION TO REALIZATION



15533

OUR STORY	5
INSPIRED BY: DESIGN 360	8
INSPIRED BY: KIRK NIX	16
INSPIRED BY: AVENUE INTERIOR DESIGN	26
INSPIRED BY: McCARTAN	34
INSPIRED BY: BUNNY WILLIAMS	40
OUR INSPIRED MIRRORS	46
INSIDE STORY: CAST RESIN	58
INSIDE STORY: FAUX HORN	62
INSIDE STORY: PRINT ON MIRROR	70
INSIDE STORY: SMOKE & MIRROR	110
INSIDE STORY: METAL WORK	118
INSIDE STORY: MARITIME INSPIRATION	132
INSIDE STORY: SUSPENDED MIRRORS	172
INSIDE STORY: LEATHER WRAPPED	188
INSIDE STORY: MIRROR FRAMED MIRRORS	198
OUR BACKLIT MIRRORS	208
INSIDE STORY: BACKLIT MIRRORS	228
OUR MAKEUP MIRRORS	254
QUICKSHIP PROGRAM	262
OUR PROCESS	264
INDEX BY NUMBER	266
INDEX BY NAME	268



# OUR STORY

Mirror Image was started in Dallas, Texas by Glenn Neugarten, in January of 1994. Committed to quality, solid partnerships and unrivaled customer service, he began building what is considered today to be a leading provider of stocked and custom built mirrors and artwork manufactured for the hospitality industry. With a keen eye for design, he and his team have built a catalog of incredible designs along with some talented partners within the hospitality industry to delight a designer's eye and an owner's budget. In 2000 Mirror Image made the move to Los Angeles. Still committed to the highest level of quality and customer service, Mirror Image expanded its presence into China in 2003 allowing hands-on control and the ability to customize every square inch of any mirror while still maintaining the highest quality. With products ranging from backlit mirrors, polyurethane, wood and MDF frames to illuminated artwork, clear, tinted, printed and antiqued mirror, our craftsman can build anything imaginable. From inspiration to realization, our clients can be assured that Mirror Image is not only a partner of theirs, but of their clients. Learn more about our products and passion for quality in the following pages.



# REFLECTING WORLDWIDE

Mirror Image is a leading manufacturer to the hospitality industry. We are proud to have supplied hotels and resorts around the world. Our collection offers inspiration from all corners of the earth with eclectic pieces worthy of any guestroom and varying styles for any hotel's aesthetics. We have supplied some of the largest properties across the globe with backlit and decorative mirrors. For a list of our favorite properties to date, email [info@mirrorimageinc.com](mailto:info@mirrorimageinc.com).



World class experience but a boutique hands on approach. DESIGN360 offers over 40 years of cumulative high-end Hotel/Hospitality and Resort Design experience, with the past 13 years as principles of our own firm. Our studio is comprised of the industries most talented multinational designers who excel in the field of Interior Design, with worldwide exposure and experience. DESIGN360 has been responsible for designing over 100 hotels, over 10,000

guestrooms, timeshare units, and numerous resort public areas across the US and 6 different countries Our work is based on building strong client relationships; successful project leads to our next project or referral. We have offices in in Santa Monica, NYNY, and New Delhi India Clients are drawn to our passion and daily approach to projects that includes enjoying the ride!



BEETLE | MS15682  
DESCRIPTION: FAUX BLACK RATTAN FRAME WITH HALO LIGHTING SHOWN IN 3000K



RORSCHACH | 15685  
DESCRIPTION: FRAMELESS CUSTOM ETCHED PATTERN ON CLEAR MIRROR





LASSO | MS15681  
DESCRIPTION: DECORATIVE  
BACKLIT FRAME SHOWN IN 3000K.

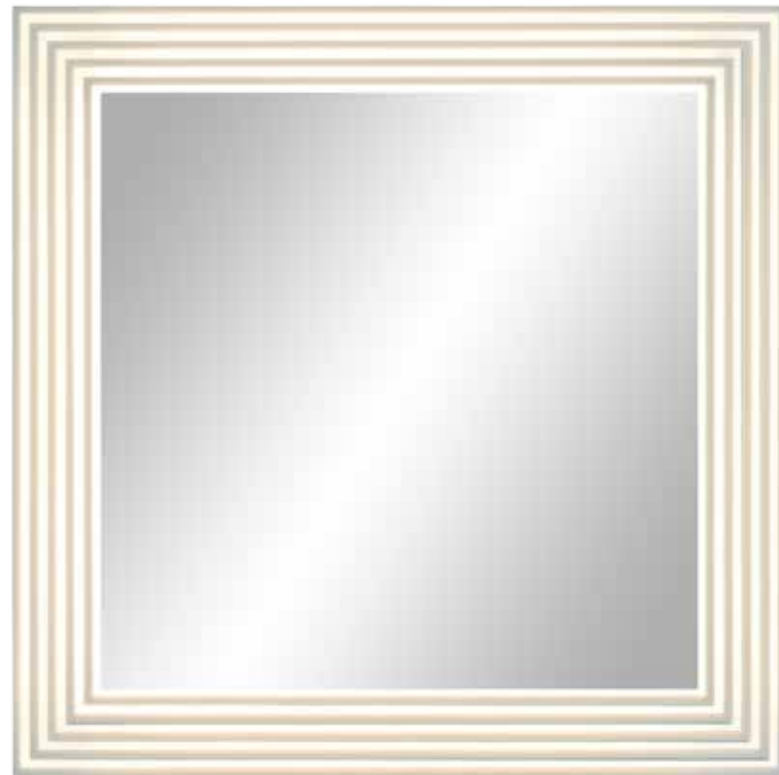

LINES | MS15690  
DESCRIPTION: DECORATIVE  
BACKLIT FRAME SHOWN IN 3000K.

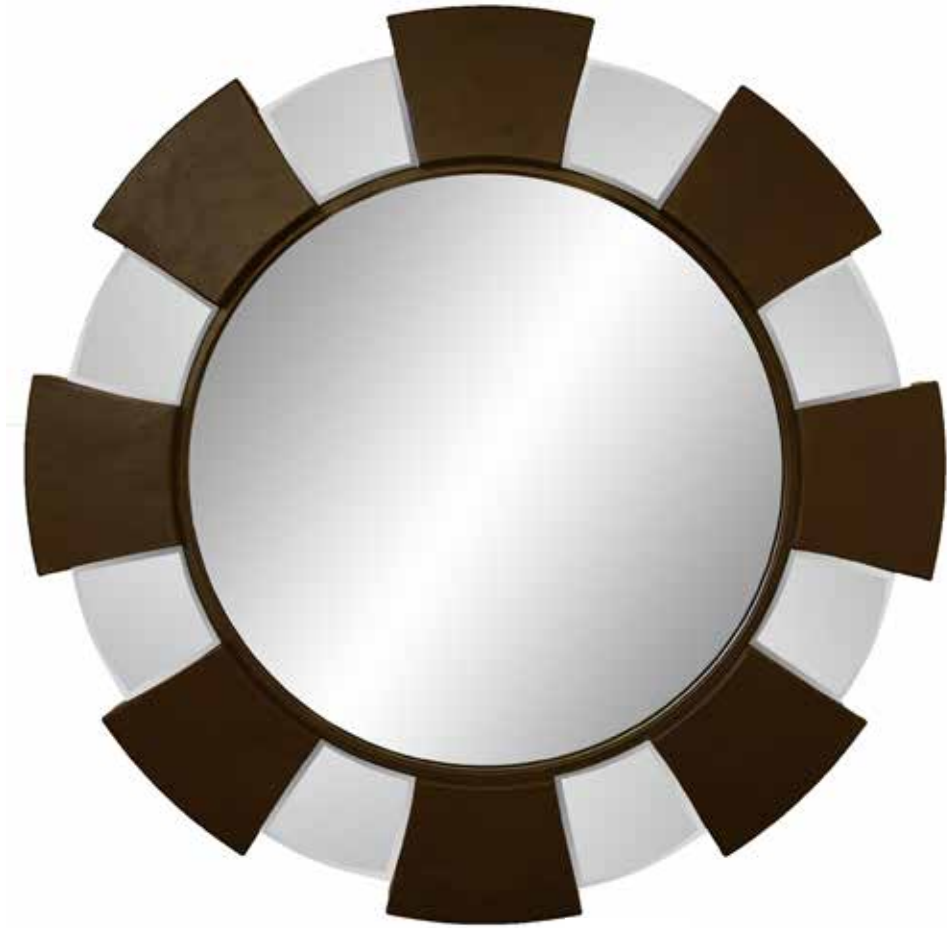

GEARS | 15688  
DESCRIPTION: DECORATIVE FRAME  
SHOWN IN FAUX BROWN LEATHER



STRIP BAR | 15686  
DESCRIPTION: DECORATIVE FRAME  
WITH SHELF SHOWN IN WHITE



WHY | 15684  
DESCRIPTION: FRAMELESS  
PRINT PATTERN SHOWN IN  
NATURAL OAK  
(SHOWN IN A SET OF 3 (CAN BE  
PURCHASED INDIVIDUALLY))



**RING OF FIRE | MS15687**  
DESCRIPTION: BACKLIT MIRROR WITH 3 INCH FROSTED PATTERN AROUND PERIMETER AND MAKEUP MIRROR WITH SWAROVSKI DETAIL SHOWN IN 3000K.

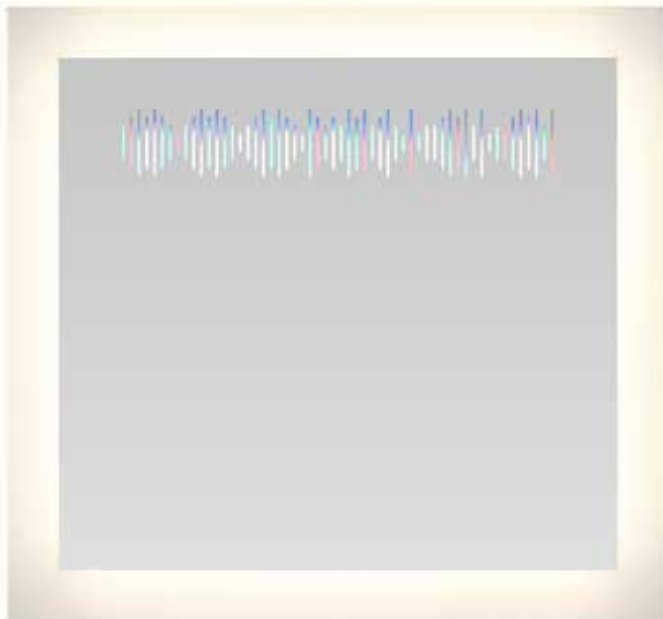

**PULSE | MS15689**  
DESCRIPTION: BACKLIT MIRROR WITH 3 INCH FROSTING AT PERIMETER AND A SOUNDWAVE PATTERN PULSING TO THE RHYTHM OF MUSIC SHOWN IN 3000K AND MUTLI-COLOR LED.



**CHECKPOINT | MS15683**  
DESCRIPTION: PRINTED SILHOUETTE WITH HALO LIGHTING SHOWN IN 3000K.





FLOWER | KNA-17007  
 MATERIAL: POLISHED  
 CHROME STANDOFFS,  
 DIAMOND AND CLEAR  
 MIRROR PANELS

# KIRK NIX

C O L L E C T I O N

An homage to his city of residence, this collection is a tip of the hat to what designer Kirk Nix humbly refers to as 'the greatest city in the world.' From sleek lines, sinuous curves and vibrant hues, the LA Collection interprets

some of the most iconic style elements of the city. In keeping with Mirror Image Hospitality's wide range of capabilities, these mirrors can be specified to custom size, color and shape.

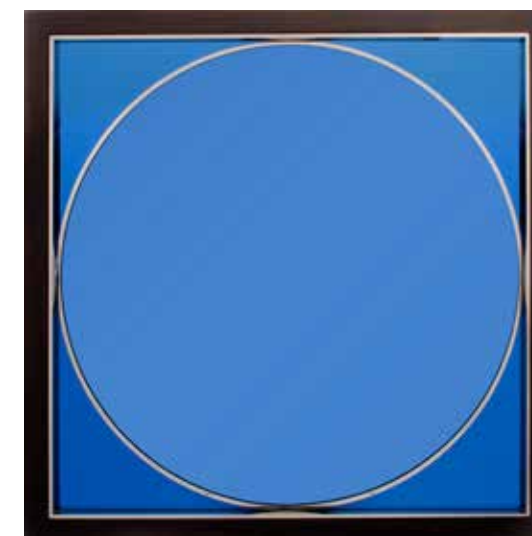
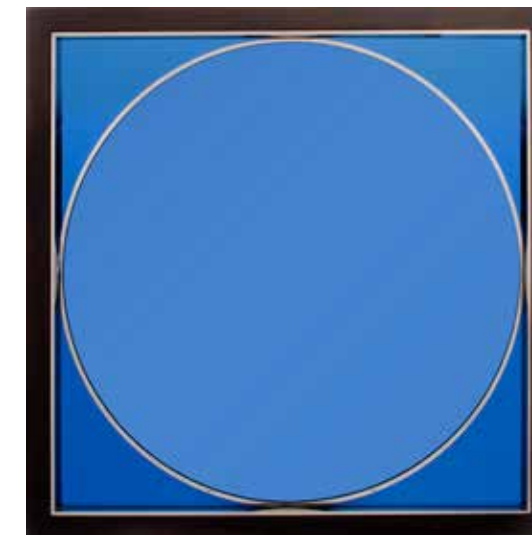
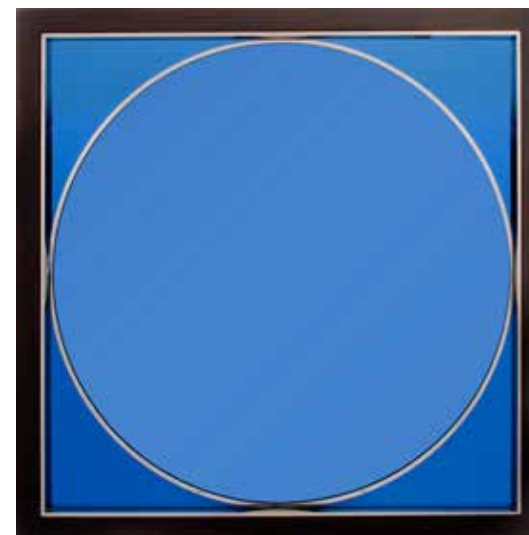

PACIFIC COAST HIGHWAY | KNA-17009  
 DESCRIPTION: POLISHED CHROME  
 DETAIL AND AQUAMARINE MIRROR  
 SHOWN IN MACASSAR  
 SHOWN IN A SET OF 4 (CAN BE  
 PURCHASED INDIVIDUALLY)

TOOL BOX

SELECT FROM A WIDE VARIETY OF VINYL OR LEATHER THROUGH US, OR PROVIDE COM.

WILSHIRE | KNA-17003  
DESCRIPTION: MATTE BLACK INSET AND GOLD DETAIL SHOWN IN PAINTED FAUX HORN



VENICE | KNA-17001  
DESCRIPTION: CLEAR AND AQUAMARINE MIRROR TILE SHOWN IN POLISHED CHROME



BEVERLY GLEN | KNA-17010  
DESCRIPTION: METAL FRAME WITH STONE TRAY SHOWN IN PAINTED BRASS



BENEDICT CANYON | KNA-17008  
DESCRIPTION: NICKEL GROMMETS SHOWN IN WRAPPED LEATHER



BEVERLY | KNA-17015

DESCRIPTION: MATTE BLACK AND  
GOLD LEAF SHOWN AS A SET OF 4,  
(CAN BE PURCHASED INDIVIDUALLY)

**TOOL BOX**  
ALL BACK-PAINTED GLASS CAN  
BE CUSTOMIZED TO THE PAINT OR  
COLOR OF YOUR CHOICE.



LAUREL CANYON | KNA-17012  
DESCRIPTION: COIL MIRROR  
SHOWN IN FAUX BRASS



MELROSE | KNA-17013  
DESCRIPTION: METAL FRAME  
PANELED MIRROR SHOWN IN  
PAINTED BRASS



SUNSET | KNA-17004  
DESCRIPTION: BACKPAINTED GLASS  
SHOWN IN POLISHED CHROME

SAN VICENTE | KNA-17014  
DESCRIPTION: POLISHED CLEAR  
MIRROR PANELS SHOWN IN  
GOLD LEAF



COLDWATER CANYON | KNA-17005  
DESCRIPTION: MATTE BLACK AND  
GOLD LEAF



RODEO | KNA-17002  
DESCRIPTION: METAL FRAME SHOWN IN  
POLISHED BRASS, MATTE BLACK AND  
WHITE SHAGREEN VINYL





# AVENUE

## INTERIOR DESIGN

Andrea DeRosa & Ashley Manhan first came together in 2005, when they quickly recognized in each other a similar philosophy, ambition, and passion for design. Andrea & Ashley have pooled their collective knowledge to form an impressive collaboration of design pedigree:

Avenue Interior Design. Mirror Image was honored to have worked with these visionaries on the SLS Hotel in Las Vegas in collaboration with Starck Design as well as a collection of backlit mirrors.

THE APOLLO | 15680 Thin profile, polished stainless steel frame with opening to mount a television



select your item, select your size, select your finish

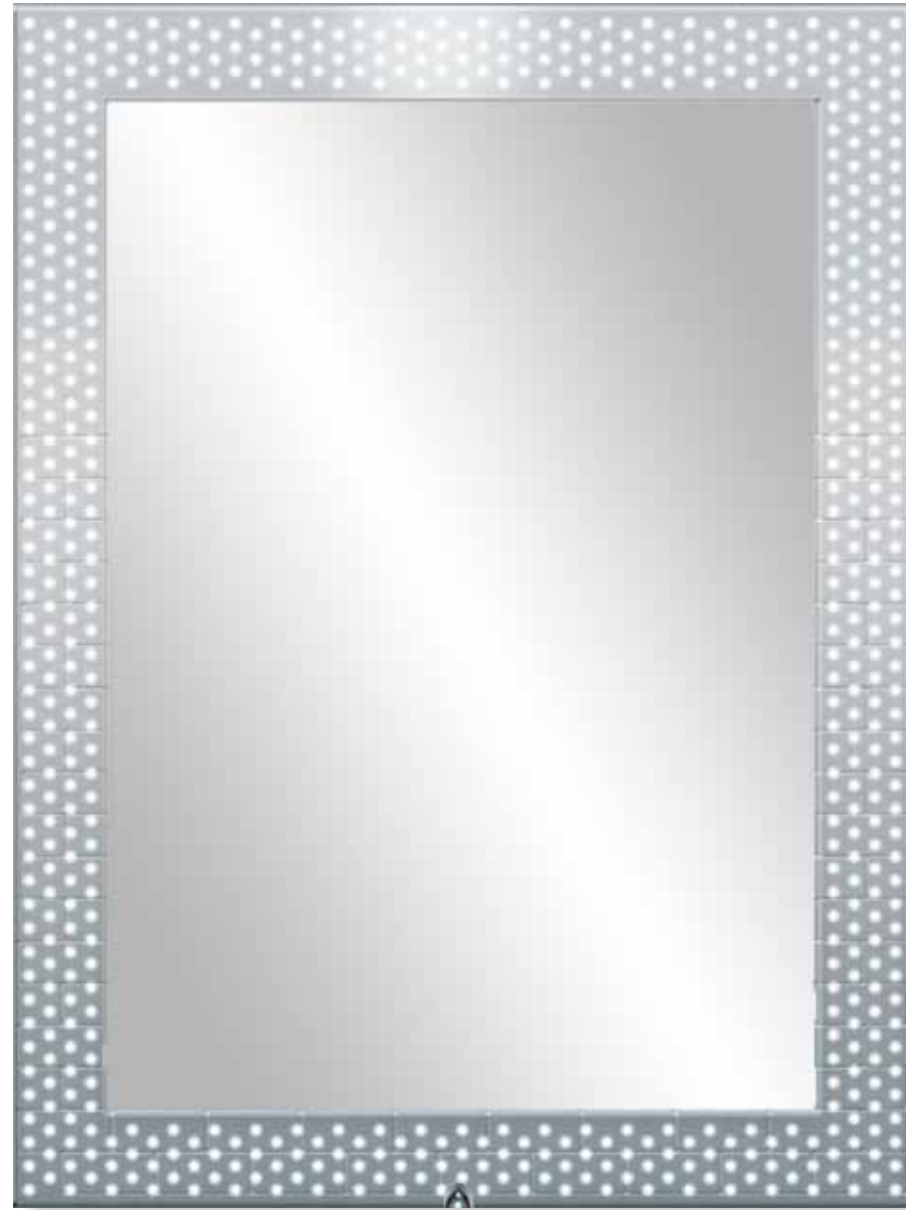

THE BROADWAY | DS80005  
DESCRIPTION: POLISHED CHROME  
FRAME WITH BACKLIT PERFORATED  
DETAIL SHOWN IN 3000K

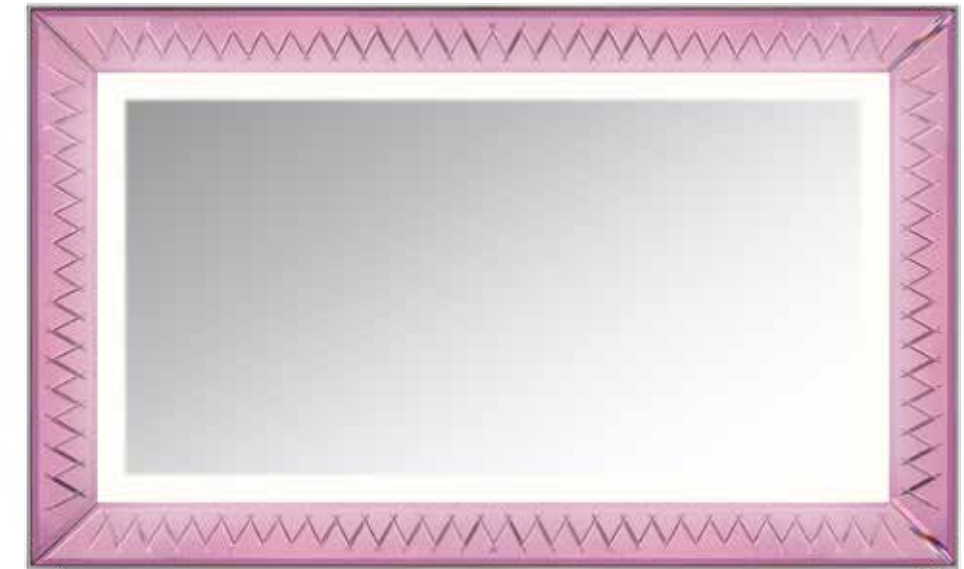

THE ALEXANDRIA | MS15206  
DESCRIPTION: CUSTOM COLORED BEVELED  
FRAME WITH DECORATIVE ETCHING DETAIL  
AND FROSTED LIGHT CHANNEL(SEE PAGE 102  
FOR MORE INFORMATION AND SELECTIONS ON  
COLORED MIRROR) SHOWN IN 3000K

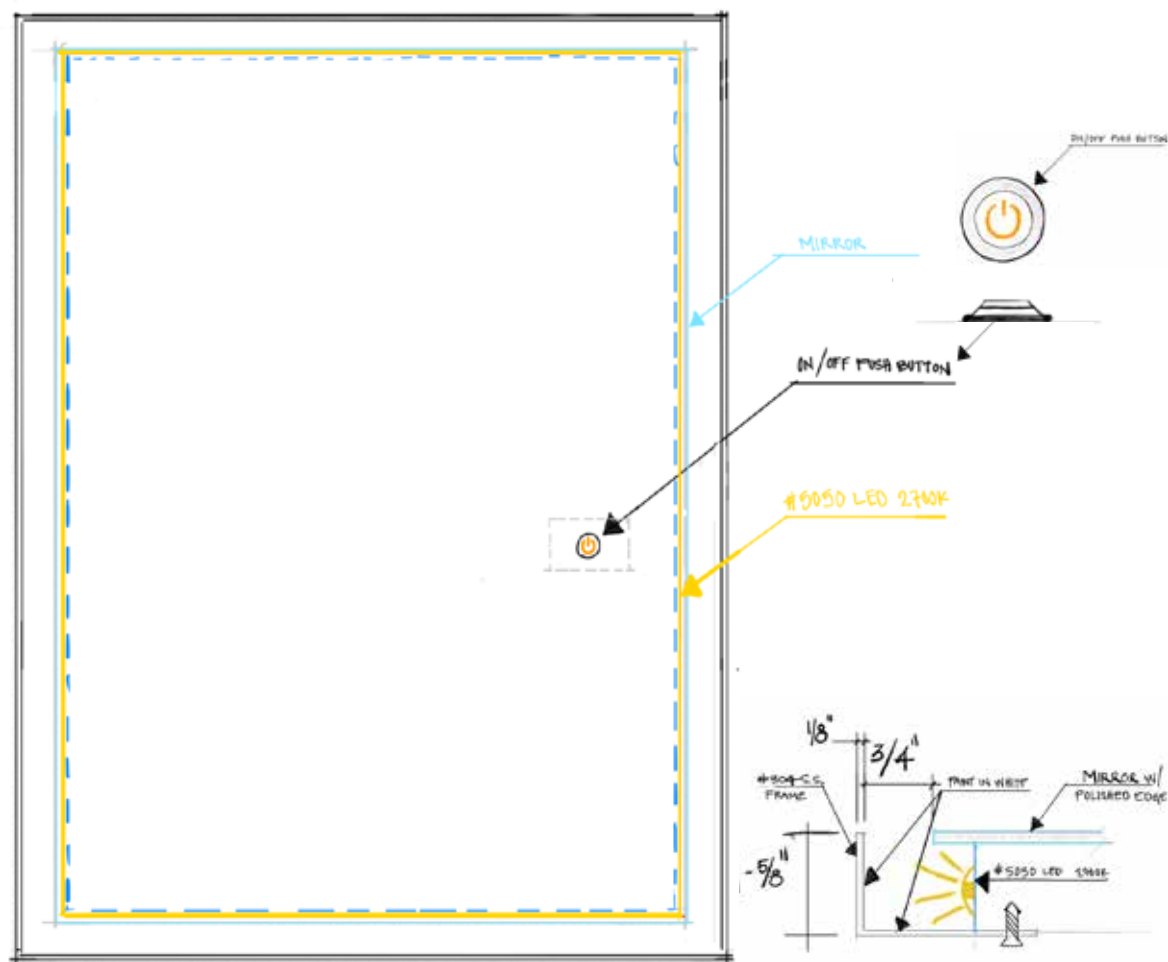

THE TANGIERS | MS15650

This mirror, envisioned by Philippe Starck for the SLS Hotel in Las Vegas, Nevada was executed by Avenue Interior Design and Mirror Image for the property. A backlit detail surrounding the full

length mirror created a practical yet attractive additional source of light for the guestrooms and an integrated power button allowing guests to turn the unit on and off with ease.





**TOOL BOX**  
 CUSTOMIZE ANY OF OUR  
 FRAMES TO CREATE YOUR HOTEL  
 SIGNAGE (BACKLIT OR OTHER)



**THE FAIRFAX | DS80002**  
 DESCRIPTION: PETITE GOOSENECK  
 LAMP AND FROSTED ROOM NUMBERS  
 SHOWN IN POLISHED CHROME



**THE FRANKLIN | DS80003**  
 DESCRIPTION: ETCHED  
 MIRROR WITH BACKLIT ROOM  
 NUMBER SIGNAGE ENCASED  
 IN A POLISHED CHROME  
 FRAME. SHOWN IN ONYX AND  
 DIAMOND MIRROR.



**THE GRAND | DS80004**  
 DESCRIPTION: ORNATE,  
 GILDED FRAME WITH  
 FROSTED LIGHT CHANNEL.  
 SHOWN IN GOLD LEAF



# McCARTAN

McCARTAN founder, Colum McCartney, is an internationally renowned interior and product designer based in New York City. Born in Ireland and a graduate of the Belfast School of Art and Design, his work is regularly published in both industry and mainstream media. He has built a unique profile and design firm that thrives on inventing distinctive intriguing environments for the hospitality industry. Mirror Image has had the privilege to manufacture inventive backlit mirrors designed by McCartney which play with objects and light in a fresh way.



SURGE | MS15011  
DESCRIPTION: ILLUMINATED MIRROR WITH DECORATIVE PATTERN

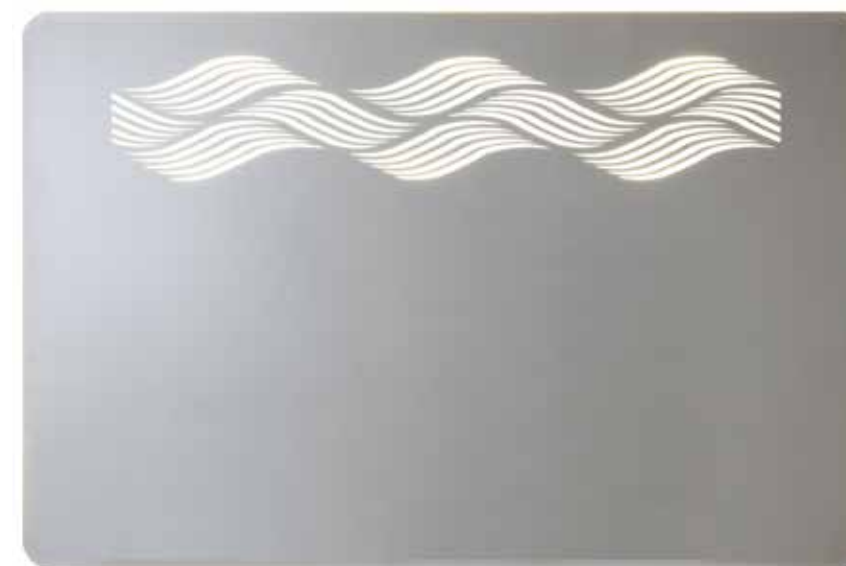

WAVELENGTH | MS15646  
DESCRIPTION: ILLUMINATED MIRROR WITH DECORATIVE PATTERN

KELVIN | MS15212  
DESCRIPTION: ILLUMINATED TABLE  
LAMP WITH BEVELED EDGE

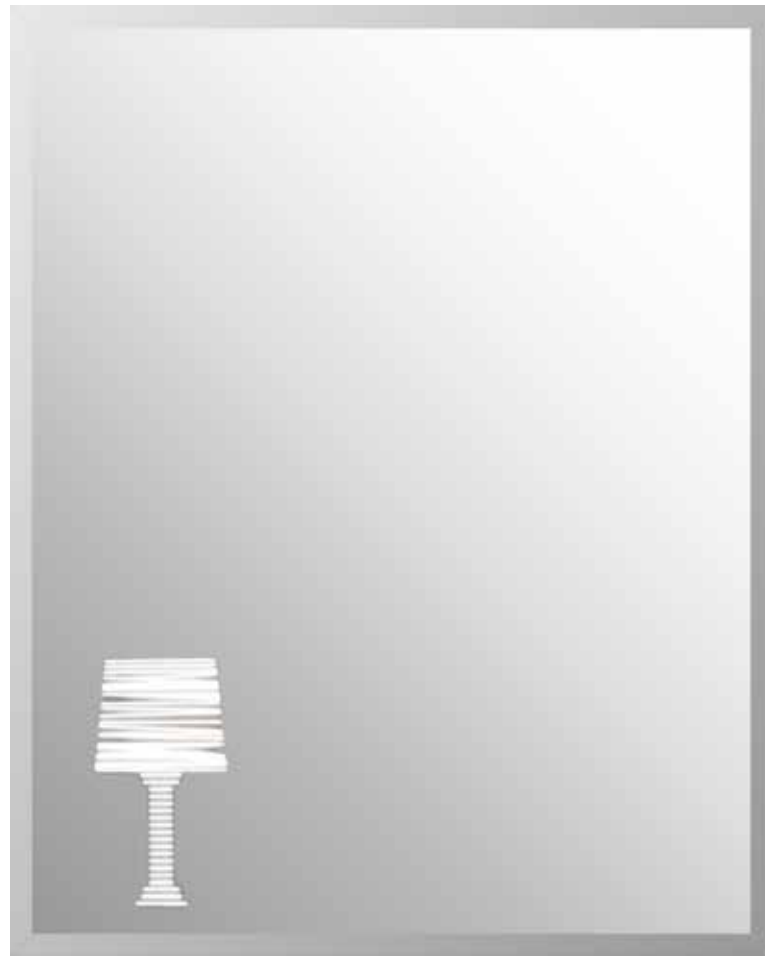

Designed for the Epiphany Hotel in Palo Alto, California

FLUX | MS15119  
DESCRIPTION: FRAMED MIRROR  
WITH ILLUMINATED PENDANT.  
ADD A TABLE OR SHELF

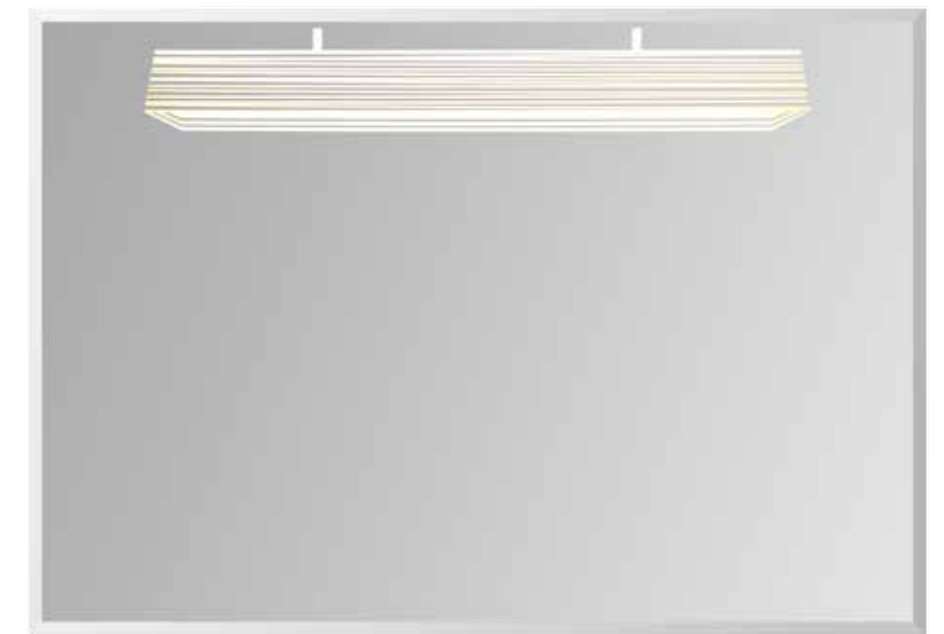

STATIC | MS15651  
DESCRIPTION: ILLUMINATED  
PENDANT WITH BEVELED EDGE





Designed for the Sheraton Grand Downtown Los Angeles, California



WIRE | MS15121  
DESCRIPTION: ILLUMINATED BIRD CAGE WITH BEVELED EDGE AND HALO LIGHTING



HYBRID | MS15120  
DESCRIPTION: ILLUMINATED BRANCH WITH BEVELED EDGE AND HALO LIGHTING



# BUNNY WILLIAMS

Bunny opened her own interior design company, Bunny Williams Incorporated, in 1988 after twenty-two years with the venerable decorating firm, Parish-Hadley Associates. Schooled in the classics, restraint and appropriateness are hallmarks of Bunny's style. Objects, patterns, textures and colors, beautifully balanced, have an appealing undisciplined look – the direct result of great focus and meticulous planning. Mirror Image is proud to have partnered with Bunny Williams to create this exciting line.

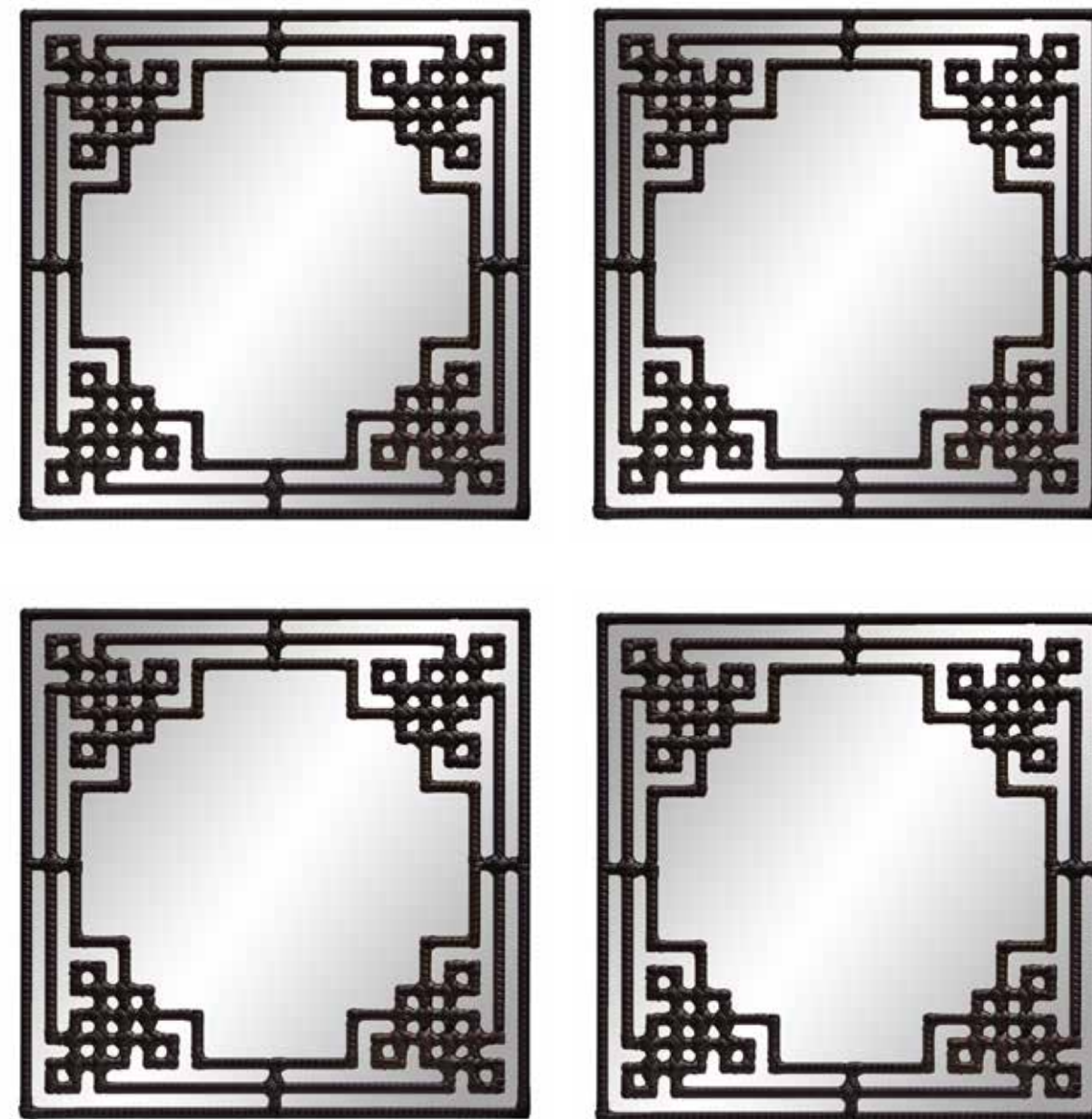

BN-16006  
DESCRIPTION: MATTE BLACK METAL  
OVERLAY ON CLEAR MIRROR.  
SHOWN IN A SET OF 4, CAN BE  
PURCHASED INDIVIDUALLY.



BN-16004  
DESCRIPTION: ILLUMINATED  
CIRCLES SHOWN IN EBONY



BN-16005  
DESCRIPTION: OVERLAID INTERLOCKING  
CIRCLES ON CLEAR MIRROR WITH  
INTERIOR LIGHTING



BN-16002  
DESCRIPTION: FAUX TORTOISE SHELL  
SHOWN IN DISTRESSED GOLD LEAF

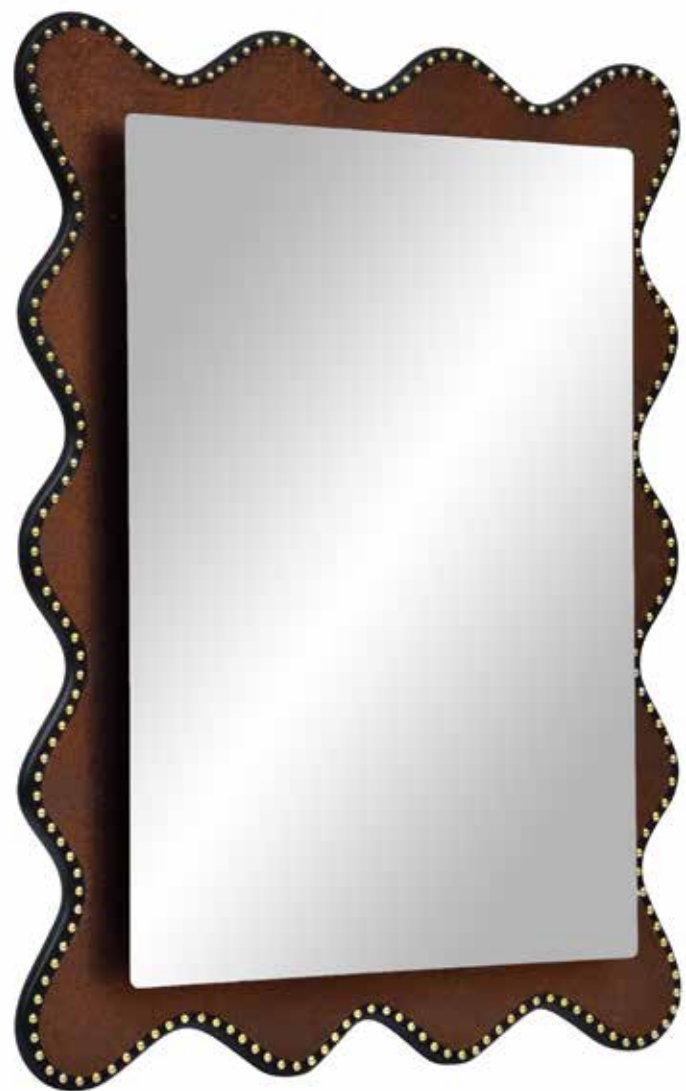

BN-16000  
DESCRIPTION: SHAGREEN VINYL  
WITH POLISHED NAILHEAD DETAIL  
AND FLOATING BEVELED MIRROR



BN-16003  
DESCRIPTION: ILLUMINATED  
GEOMETRIC BACKLIT MIRROR

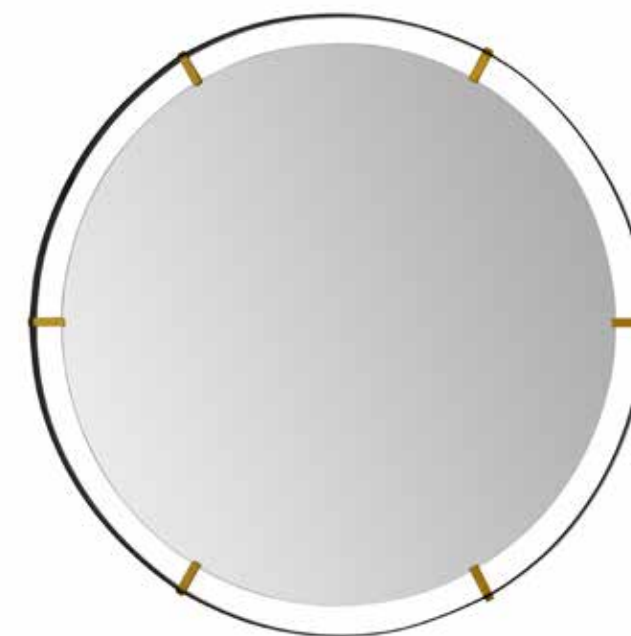

BN-16001  
DESCRIPTION: BLACK METAL  
FRAME WITH GOLD BAND DETAIL



# OUR INSPIRED MIRRORS

The following is a collection we have curated inspired for the hospitality industry. Please use these pieces as a jumping off point.

Customize every square inch! We hope you enjoy it as much as we have enjoyed putting it together.

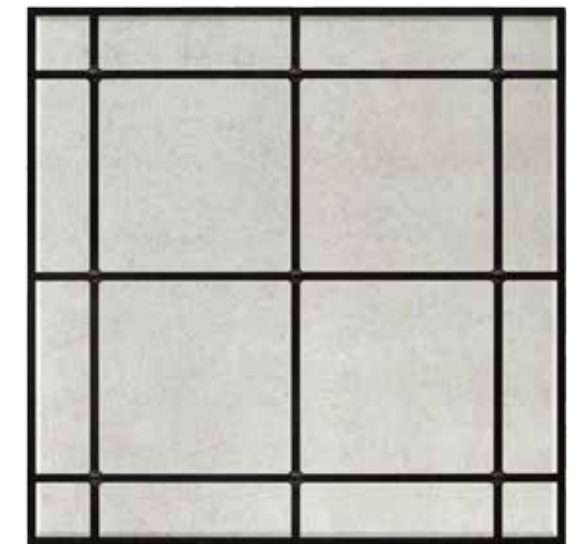
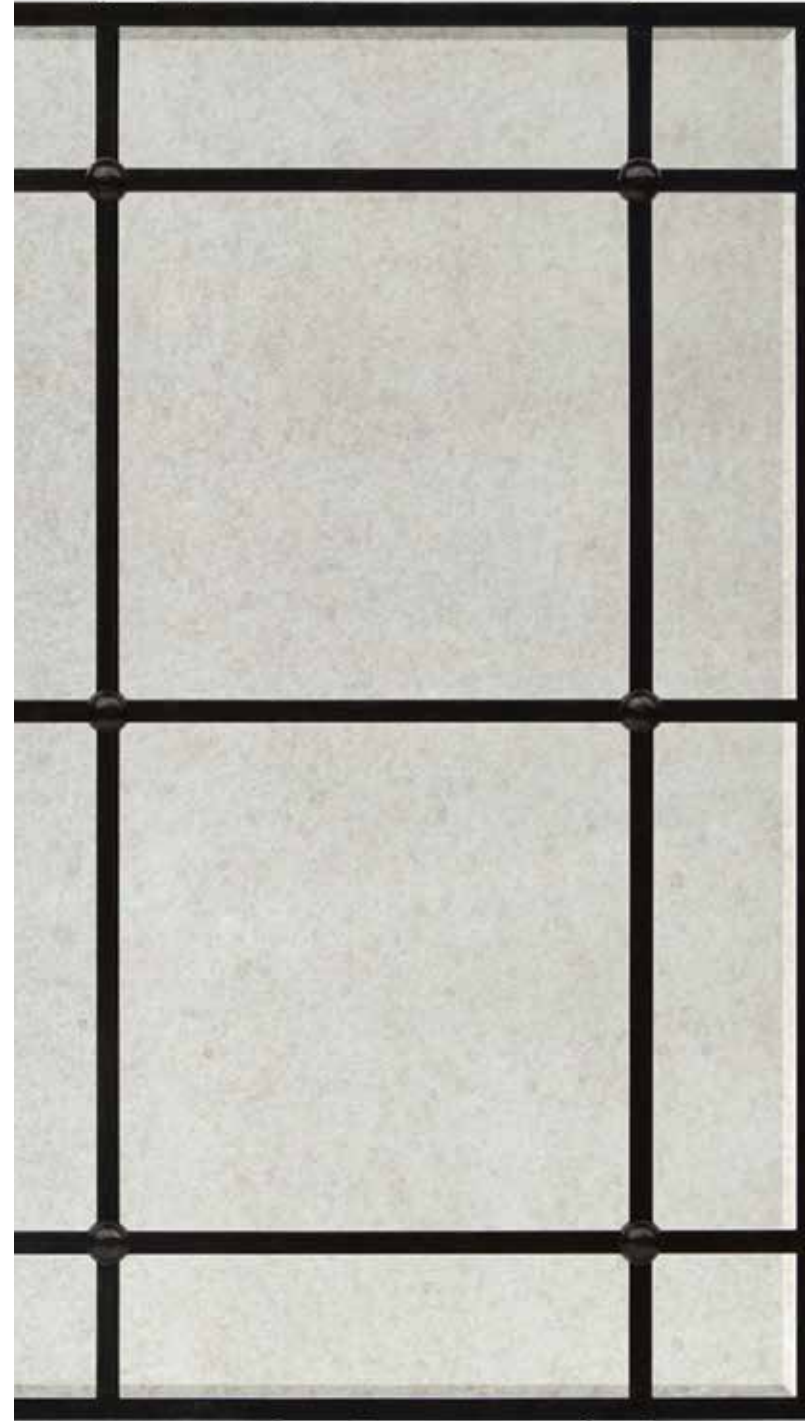

THE ALIBASTER | 15513  
DESCRIPTION: METAL FRAME  
OVERLAY WITH BEVELED ANTIQUE  
SHOWN IN BLACK





JOSIE | 15164  
DESCRIPTION: TRANSITIONAL  
FRAME SHOWN IN SILVER LEAF



GILBERT | 15168  
V-GROOVE PANELS SHOWN  
IN CHAMPAGNE SILVER



MARILLA | 10201  
DESCRIPTION: GOLD FILLET,  
V-GROOVE MIRROR, WITH  
DISTRESSED GOLD ROSETTES  
SHOWN IN ESPRESSO



TOOL BOX

CUSTOMIZE YOUR RIVETS IN ANY SIZE, FINISH OR SHAPE

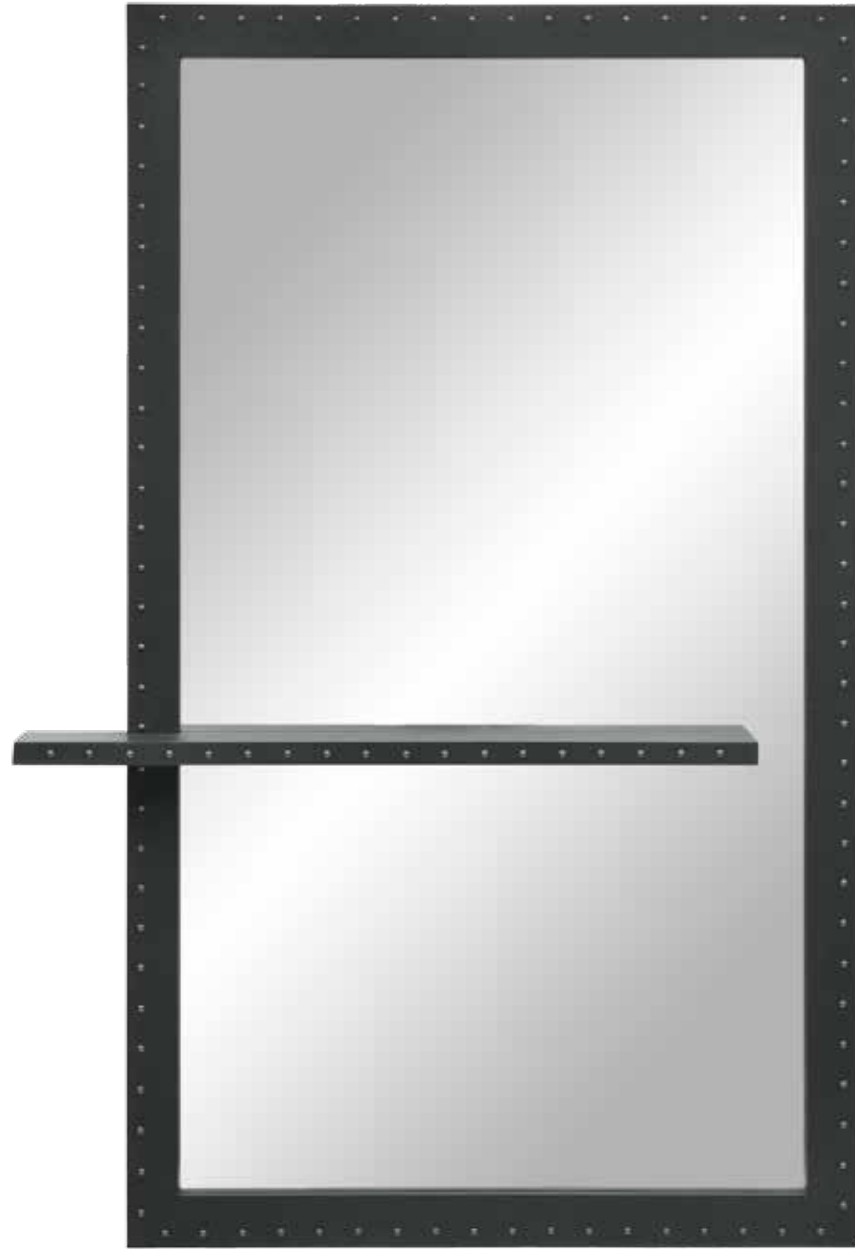

VIVIAN | 15007  
DESCRIPTIONS: POLISHED CHROME RIVETS WITH TRAY SHOWN IN MATTE BLACK

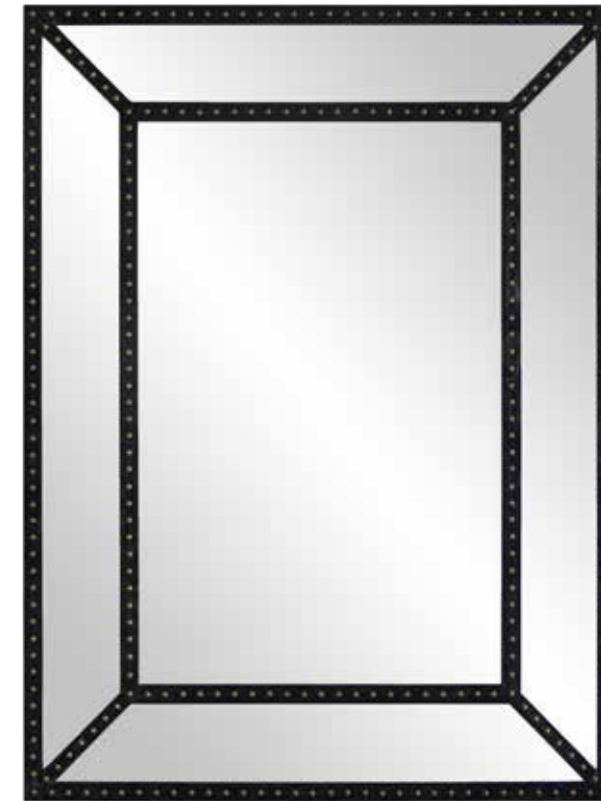

KIT | 15594  
DESCRIPTION: PANELED MIRROR WITH ANTIQUED BRASS RIVETS SHOWN IN MATTE BLACK

BRIDGET | 15173  
DESCRIPTION: POLISHED BRONZE RIVETS SHOWN IN MATTE BLACK

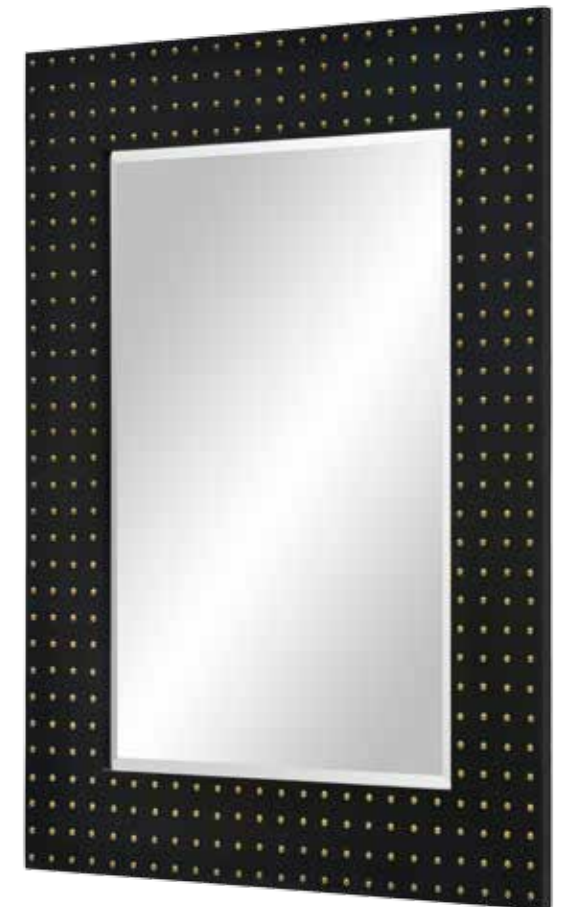

TOOL BOX

ADD A SHELF OR HOOK TO ANY ITEM TO HOLD AMENITIES OR A ROBE

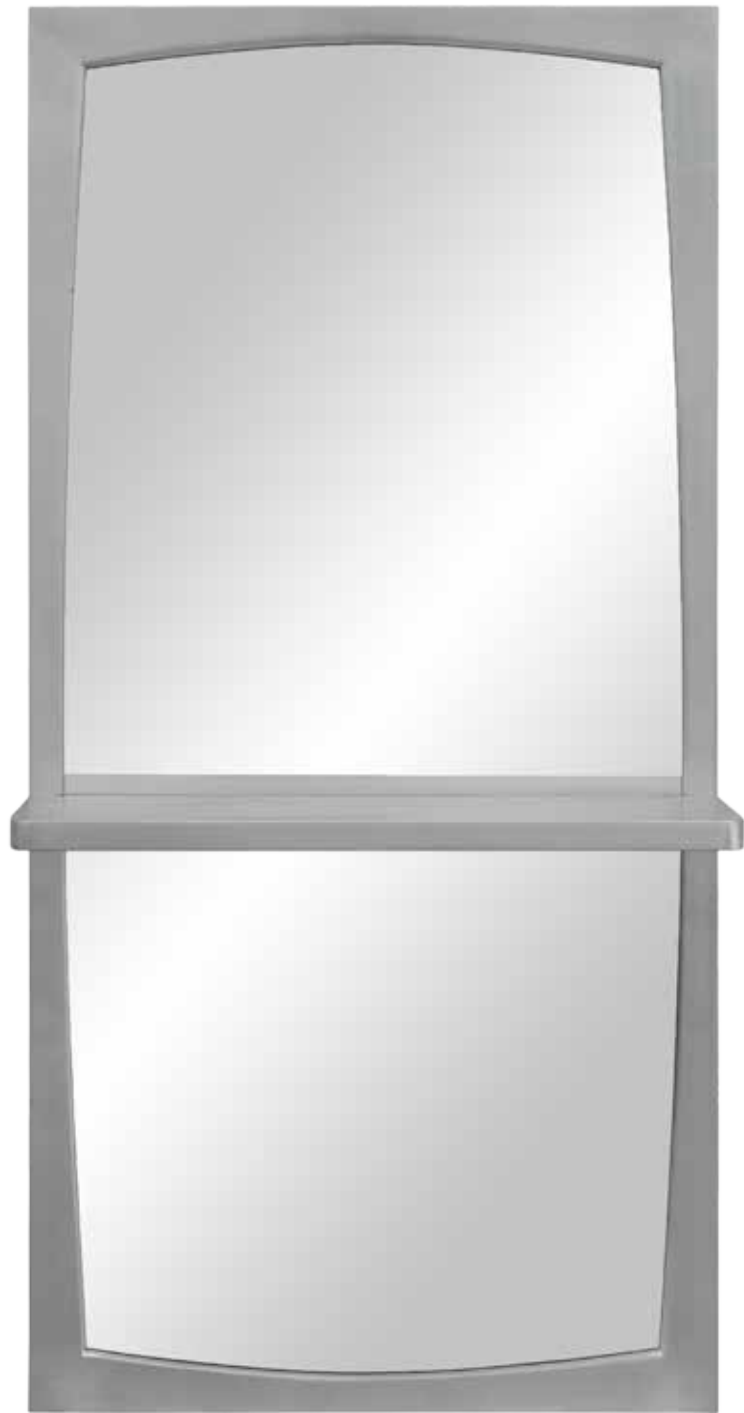

PERRY | 15063  
DESCRIPTION: DECORATIVE  
FRAME WITH SHELF SHOWN IN  
SILVER LEAF



GWEN | 15180  
DESCRIPTION: OVAL  
CONTEMPORARY FRAME  
SHOWN IN SILVER LEAF



RAE | 15524  
DESCRIPTION: CONTEMPORARY  
ROUND FRAME SHOWN IN  
CHAMPAGNE SILVER LEAF



GERRY | 15064  
DESCRIPTION: DECORATIVE FRAME  
SHOWN IN CHAMPAGNE SILVER LEAF



MOANA | 15556  
DESCRIPTION: CORAL INSPIRED  
DECORATIVE MIRROR SHOWN  
IN CHAMPAGNE SILVER LEAF

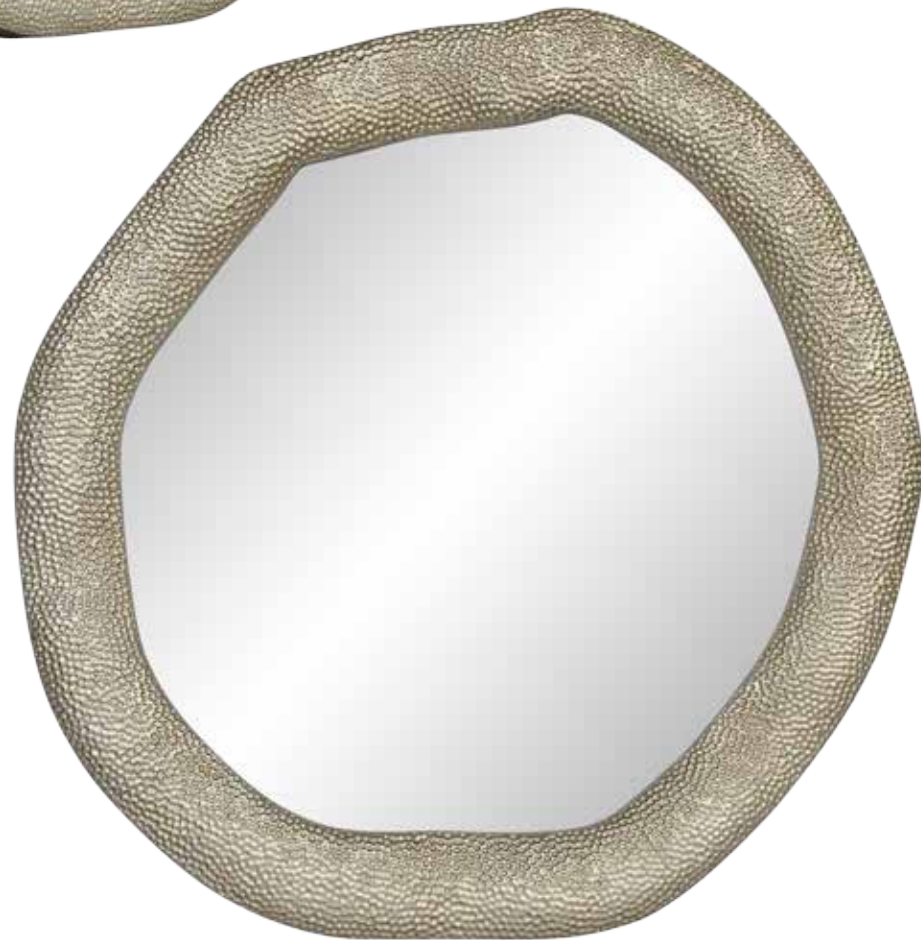

SMASH | 15193  
DESCRIPTION: CRACKLED  
MIRROR SHOWN IN  
CHAMPAGNE SILVER

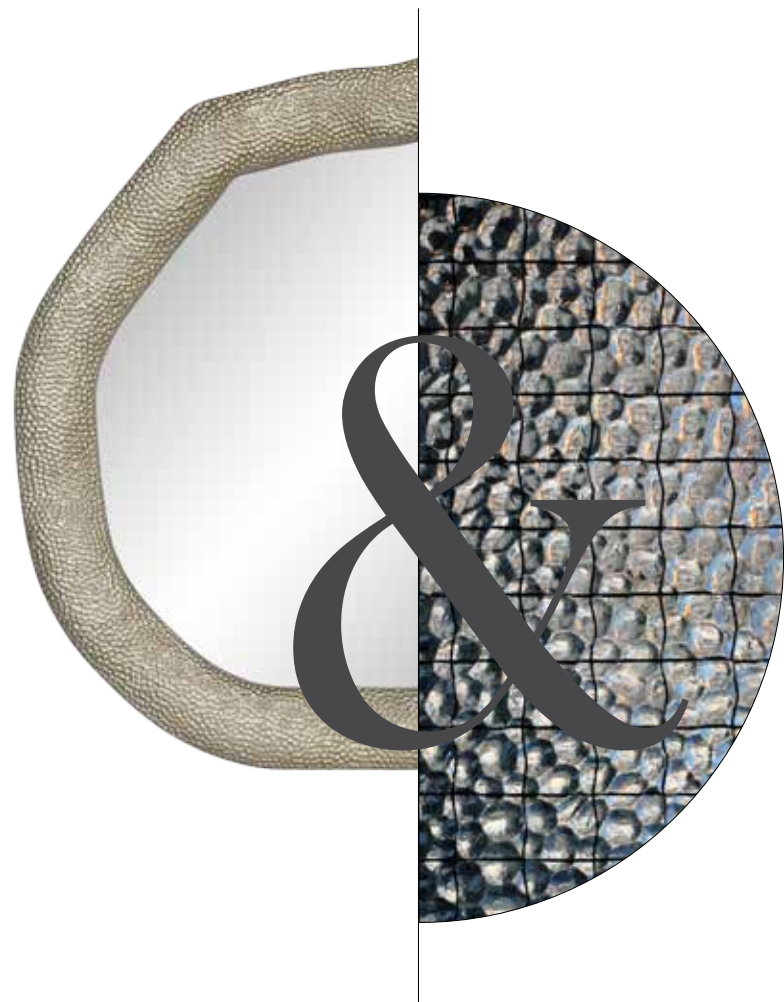

# CAST RESIN

Cast resin, or polyurethane, can be used to value engineer most designs and shapes for larger production quantities. We use Grade A thermosetting resin. The resin is poured into a mould made out of vulcanized silicone rubber. The mould is loaded into a vacuum chamber

to extract bubbles. All products that are made with cast resin are sanded and finished by hand, adding sealant to make it durable for the hospitality environment. The result is not only a cost effective piece, it also boasts light weight helping installers, handling and freight costs.





GEMINI | 15165  
DESCRIPTION: INTERLOCKING OVAL  
FRAMES SHOWN IN GOLD LEAF



GIO | 15660  
DESCRIPTION: DECORATIVE FRAME  
WITH EASE ROUND CORNERS ON  
TOP SHOWN IN GOLD LEAF



CLEO | 15533  
DESCRIPTION: HEXAGONAL FRAME SHOWN  
IN MATTE BLACK AND GOLD LEAF

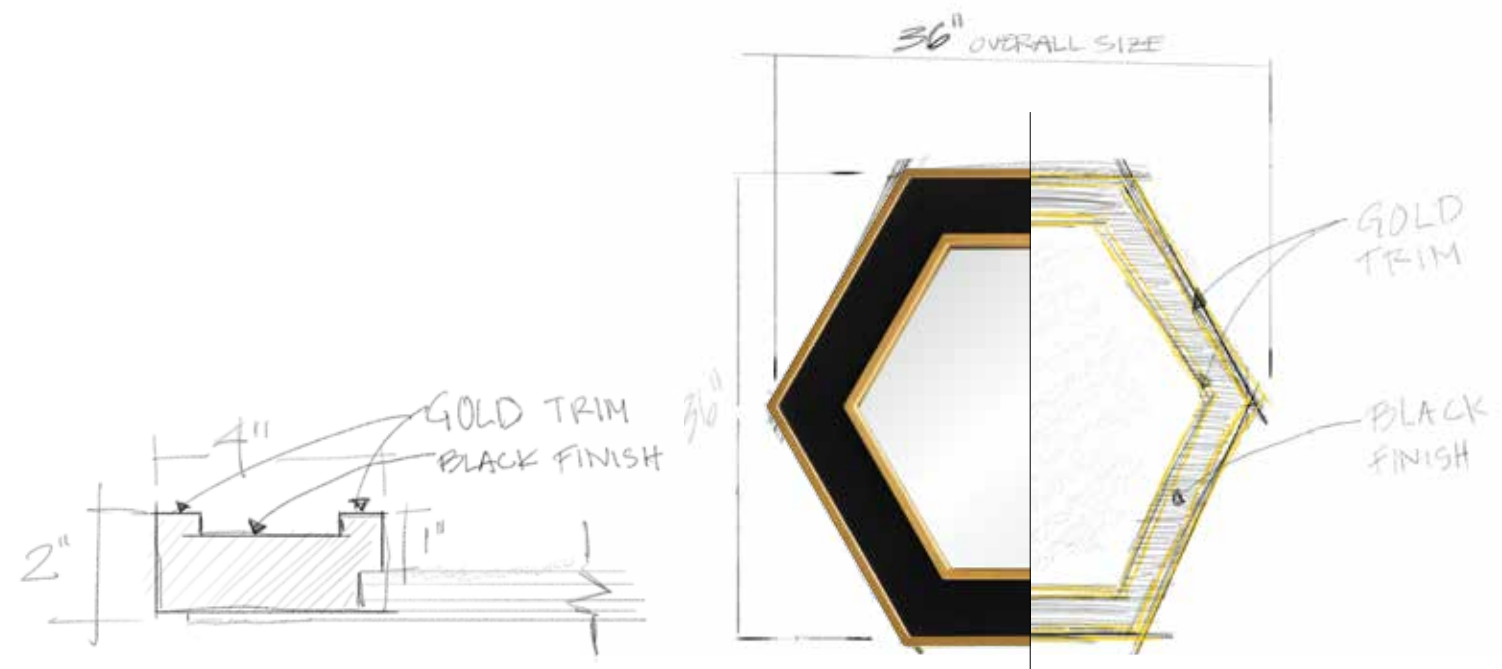

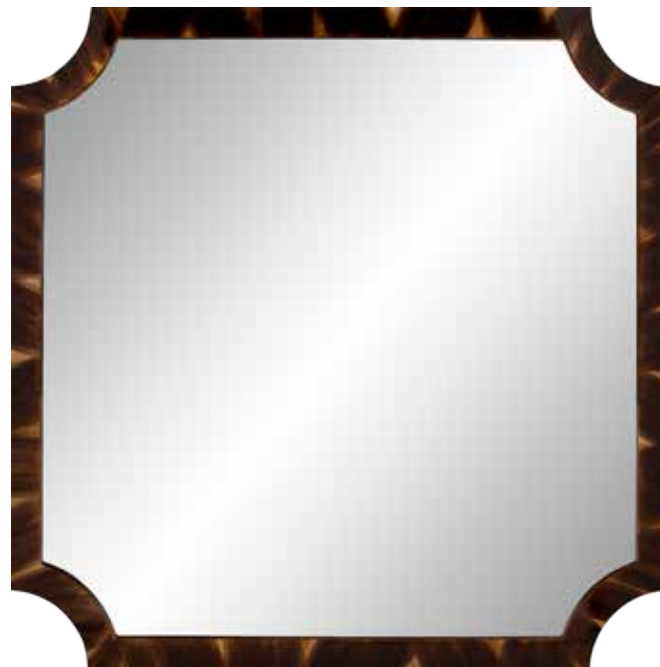

ZAZU | 15506  
DESCRIPTION: DECORATIVE  
FRAME WITH INVERSE CORNERS  
SHOWN IN FAUX HORN

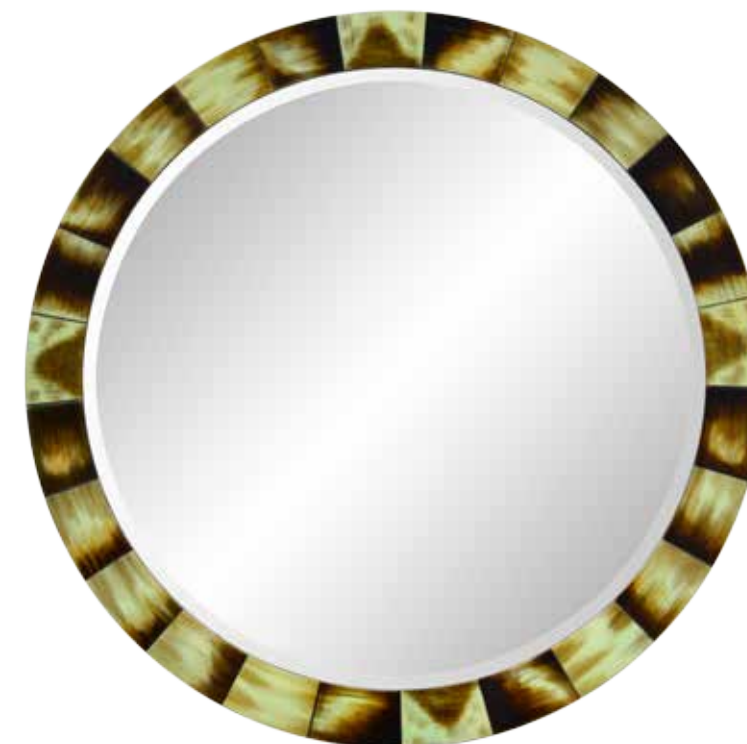

NALA | 15599  
DESCRIPTION: DECORATIVE ROUND  
FRAME SHOWN IN LIGHT FAUX HORN

# FAUX HORN

Horn and shell finishes have a luxurious and expensive feel. It is widely popular but expensive to manufacture. Although, we use cruelty-free horn, our artisans have become skilled at creating the same look for a fraction of the price with the use of hand finishing.





SUMMER | 15623  
DESCRIPTION: DECORATIVE FRAME  
WITH OVERLAY ON CLEAR MIRROR  
SHOWN IN GOLD AND SILVER LEAF



AUTUMN | 15675  
DESCRIPTION:  
DECORATIVE PETAL FRAME  
SHOWN IN SILVER LEAF



VIVIANA | 15554  
DESCRIPTION: DECORATIVE FRAME  
SHOWN IN GOLD LEAF



MIA | 15616  
DESCRIPTION: OVAL FRAME WITH VARYING  
DEPTHS. SHOWN IN WHITE LACQUER  
FINISH WITH GOLD LEAF DETAIL



ALEXANDER | 15531  
DESCRIPTION: CONTEMPORARY  
FRAME SHOWN IN SILVER LEAF



JULIUS | 15170  
DESCRIPTION: CONTEMPORARY  
FRAME SHOWN IN WHITE  
LACQUER WITH SILVER LEAF TRIM



STEENA | 15674  
DESCRIPTION: CONTEMPORARY FRAME  
SHOWN IN MATTE BLACK WITH SILVER LEAF





VINCENT | 15501  
DESCRIPTION: DECORATIVE  
FRAME SHOWN IN SILVER LEAF

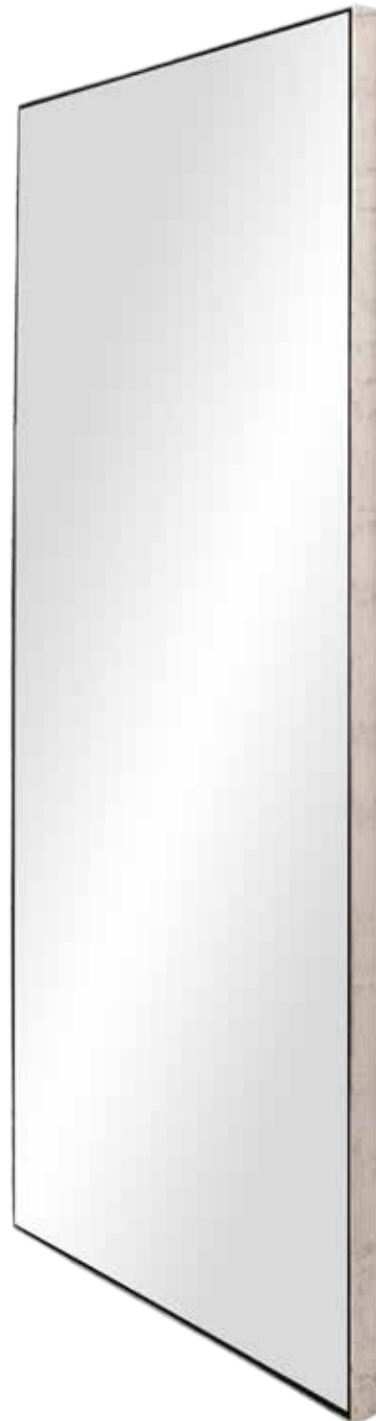

NELLY | 15161  
DESCRIPTION: MINIMALIST  
METAL FRAME WITH REVEAL.  
SHOWN IN SILVER LEAF



LIEF | 15030  
DESCRIPTION: PENDANT FRAME  
SHOWN IN GOLD LEAF



PETAL | 15029  
DESCRIPTION: MINIMALIST  
FRAME SHOWN IN GOLD LEAF



# PRINT ON MIRROR

Mirror Image offers art consulting services at no charge when you purchase and print your images with us. We accept any imagery from our clients to print on their behalf. While we can print on paper, canvas, aluminum and wood, we can also print on mirror. As with all of our products, our print on mirror is printed for durability including chemical cleaning products and the hospitality environment.



TOOL BOX

ADD SOME LOCAL FLAVOR TO ANY OF OUR MIRRORS BY PRINTING AN IMAGE OF JUST ABOUT ANYTHING.



GINO | 15525  
DESCRIPTION: ARCHITECTURAL PRINT ON MIRROR. (HISTORIC BUILDING IN BALBOA PARK. SELECTED FOR THE SOLAMAR HOTEL IN SAN DIEGO. DESIGNED BY PALLETEUR)



CASPER | 15597  
DESCRIPTION: PRINTED WATERCOLOR ON MIRROR SHOWN IN ANTIQUE BRONZE METAL



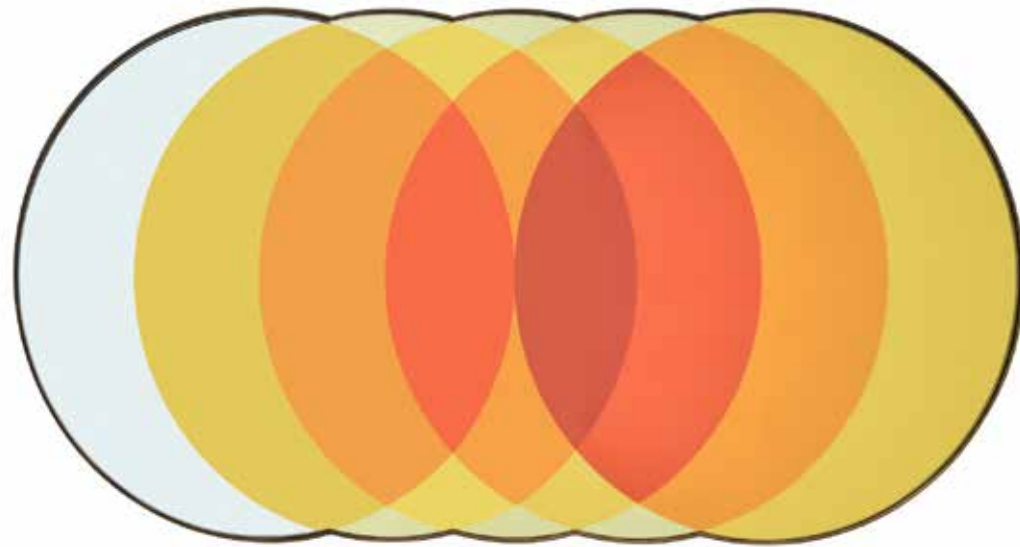

ROGUE | 15582  
DESCRIPTION: METAL FRAME  
WITH OMBRE PRINTED CIRCLES IN  
SHADES OF CITRUS

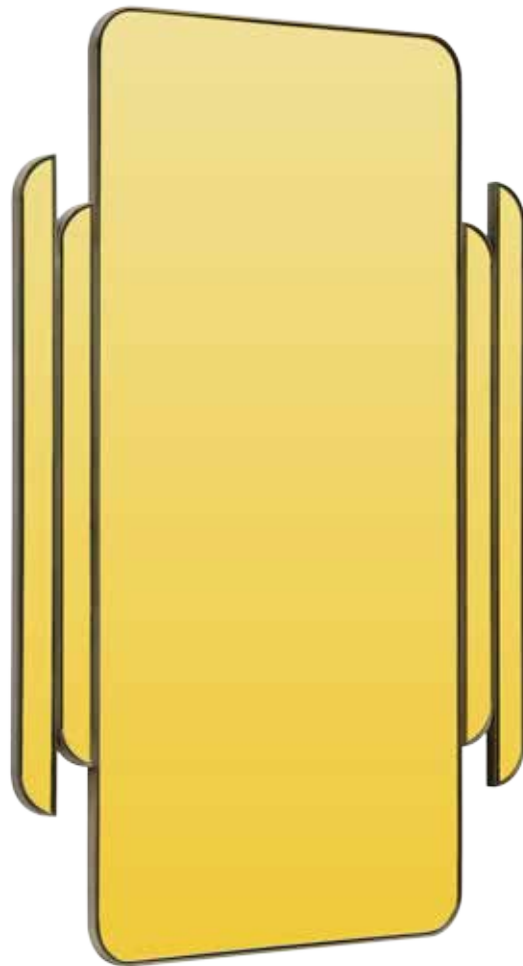

CORONA | 15662  
DESCRIPTION: GOLD MIRROR SHOWN  
IN ANTIQUE BRUSH BRONZE



FELIX | 15587  
DESCRIPTION: AQUAMARINE  
AND CLEAR INSET MIRROR  
SHOWN IN GOLD LEAF

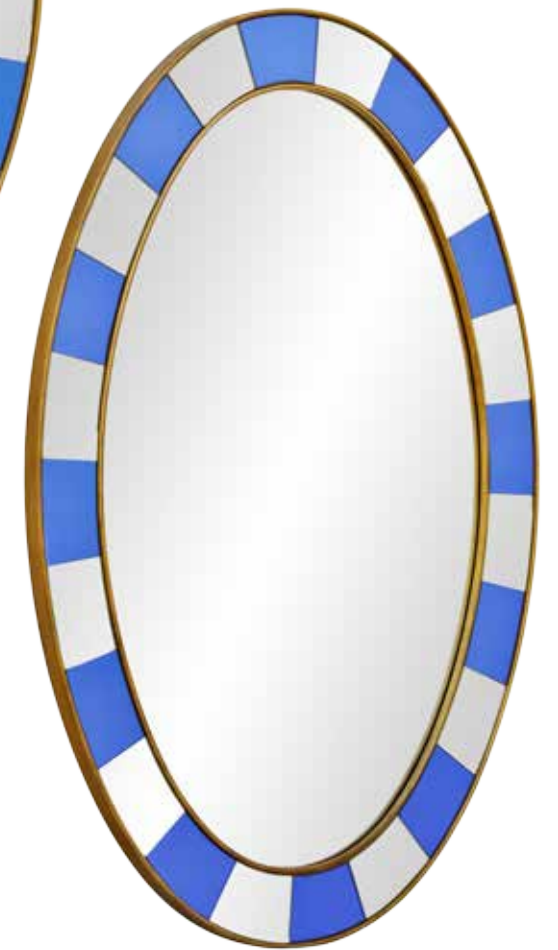



VAPOR | MS15545  
DESCRIPTION: BACKLIT MIRROR WITH ART  
PANELS, FROSTED GLASS AND MIRROR



SPLASH | MS15192  
DESCRIPTION: ART PAINTED ON THE  
MIRROR WITH HALO LIGHTING



SPLATTER | MS15581  
DESCRIPTION: BACKLIT MIRROR WITH ART  
PANELS, FROSTED GLASS AND MIRROR



SWITCH | MS15208  
DESCRIPTION: PRINT ON  
ACRYLIC LEAVING JUST THE  
CHANDELIER LIT



EVE | 15596  
DESCRIPTION: CONTEMPORARY  
WINDOW FRAME WITH EASED  
CORNERS SHOWN IN WHITE LACQUER



EVE | 15596  
DESCRIPTION: CONTEMPORARY  
WINDOW FRAME WITH EASED  
CORNERS SHOWN IN LILAC

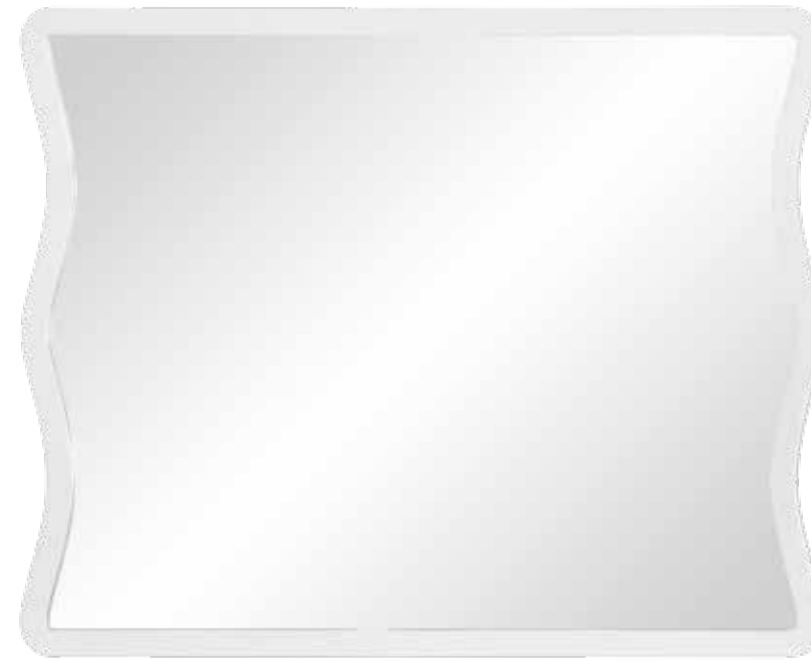

NINA | 15000  
DESCRIPTION: DECORATIVE FRAME  
SHOWN IN WHITE LACQUER

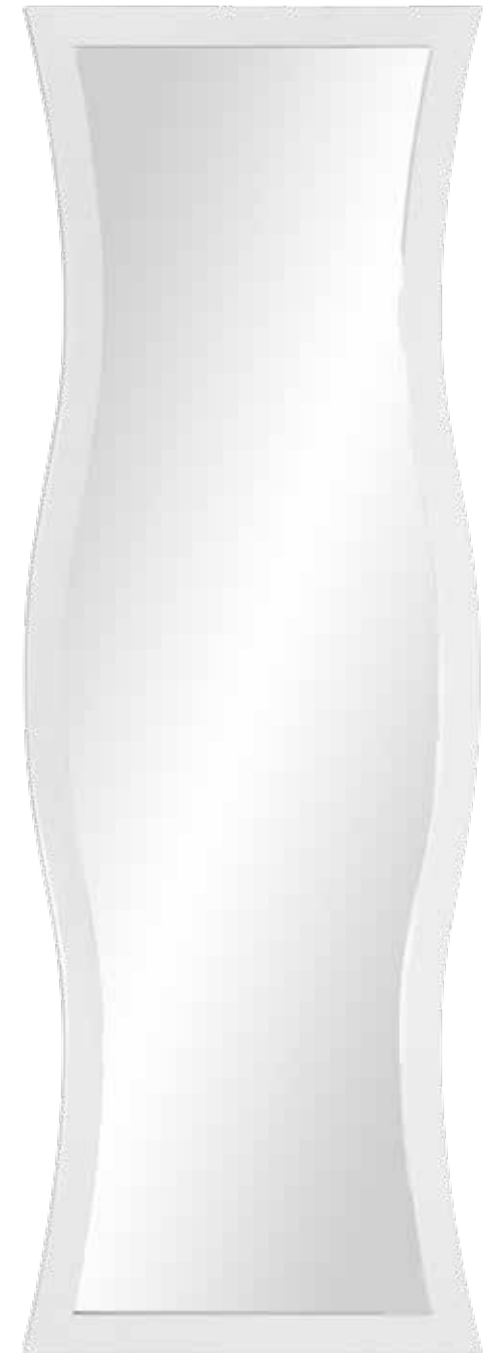

ANNIE | 15001  
DESCRIPTION: DECORATIVE FRAME  
SHOWN IN WHITE LACQUER



LIYA | 15174  
DESCRIPTION: DECORATIVE  
FRAME SHOWN IN CHAMPAGNE  
SILVER LEAF FINISH WITH  
ANTIQUÉ MIRROR

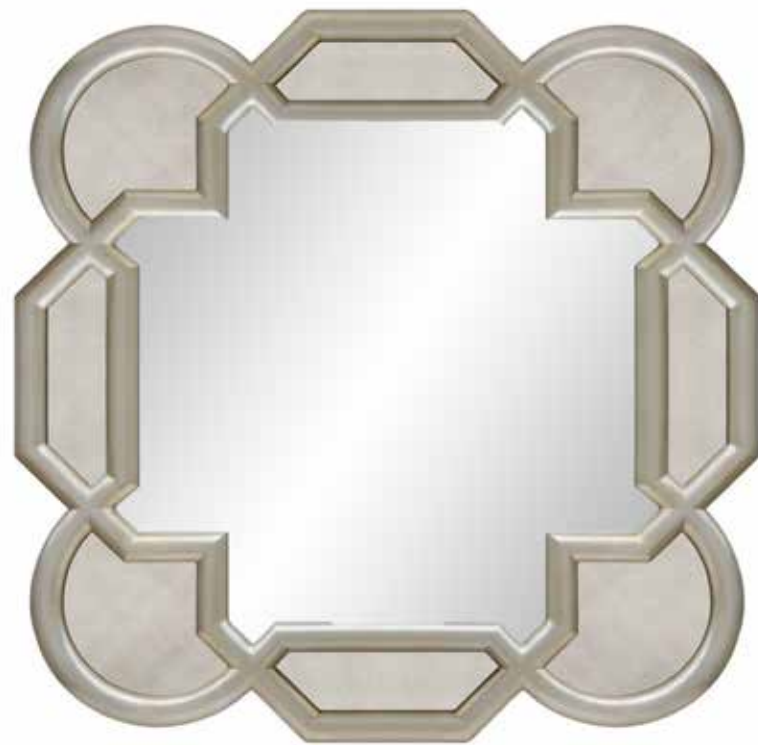

JAIME | 15642  
DESCRIPTION: PENDANT FRAME  
SHOWN IN SILVER LEAF



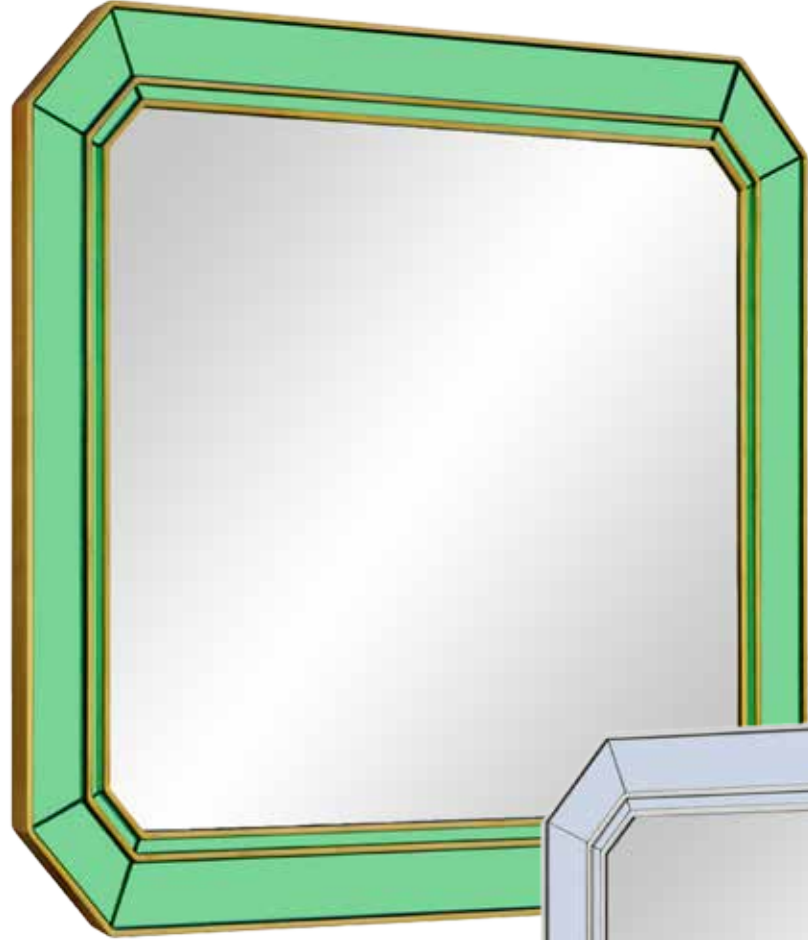

BIZU | 15022  
DESCRIPTION: DECORATIVE  
MIRROR FRAMED MIRROR  
SHOWN IN JADE MIRROR AND  
GOLD LEAF ACCENT

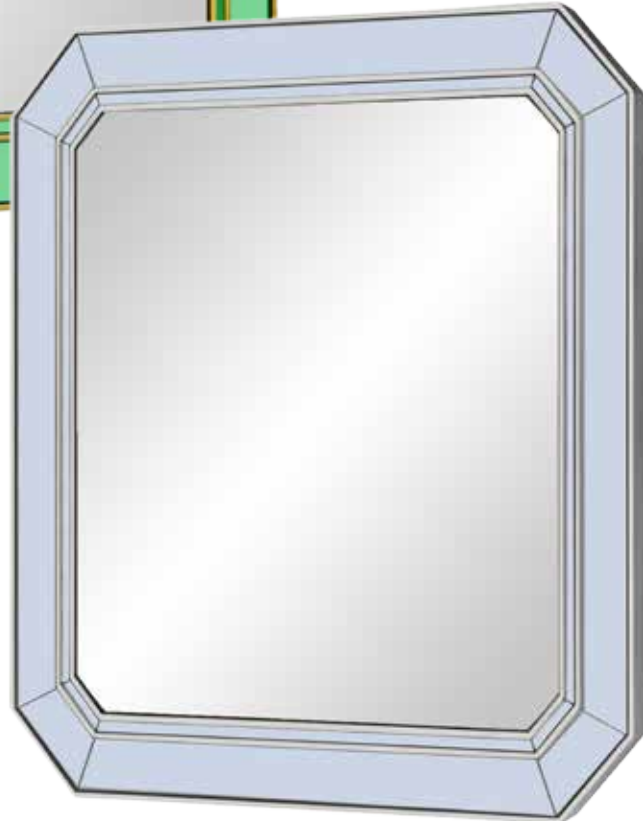

YVES | 15023  
DESCRIPTION: DECORATIVE  
MIRROR FRAMED MIRROR  
SHOWN IN DIAMOND MIRROR  
AND SILVER LEAF ACCENT

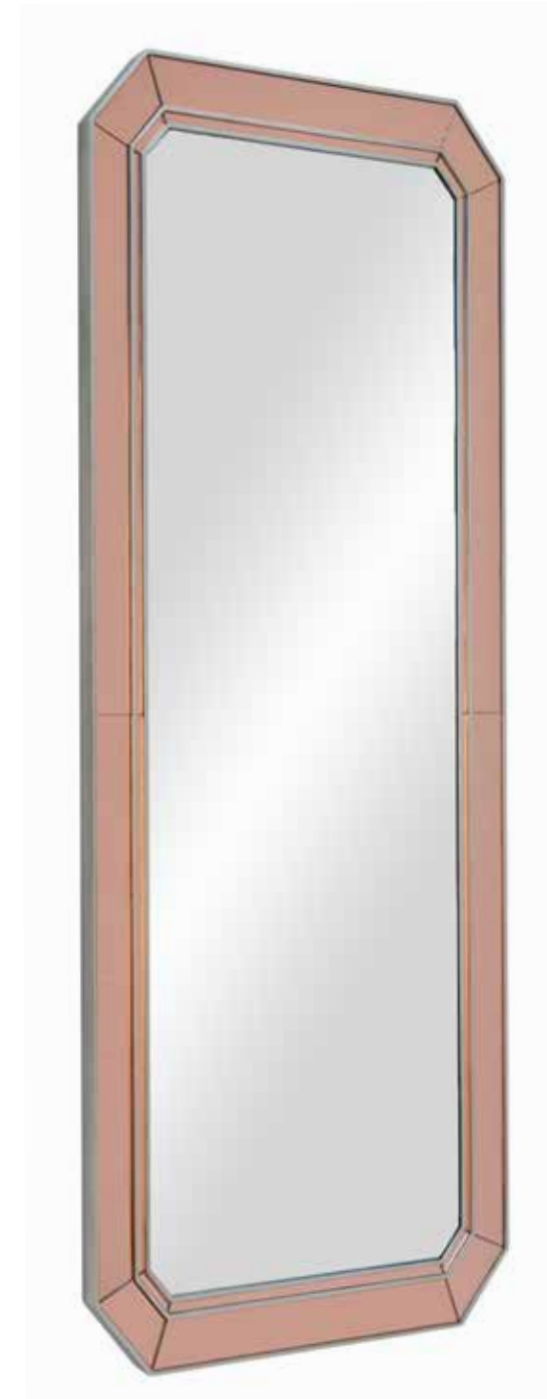

HOLLY | 15024  
DECORATIVE MIRROR  
FRAMED MIRROR SHOWN IN  
ROSE GOLD MIRROR AND  
SILVER LEAF ACCENT

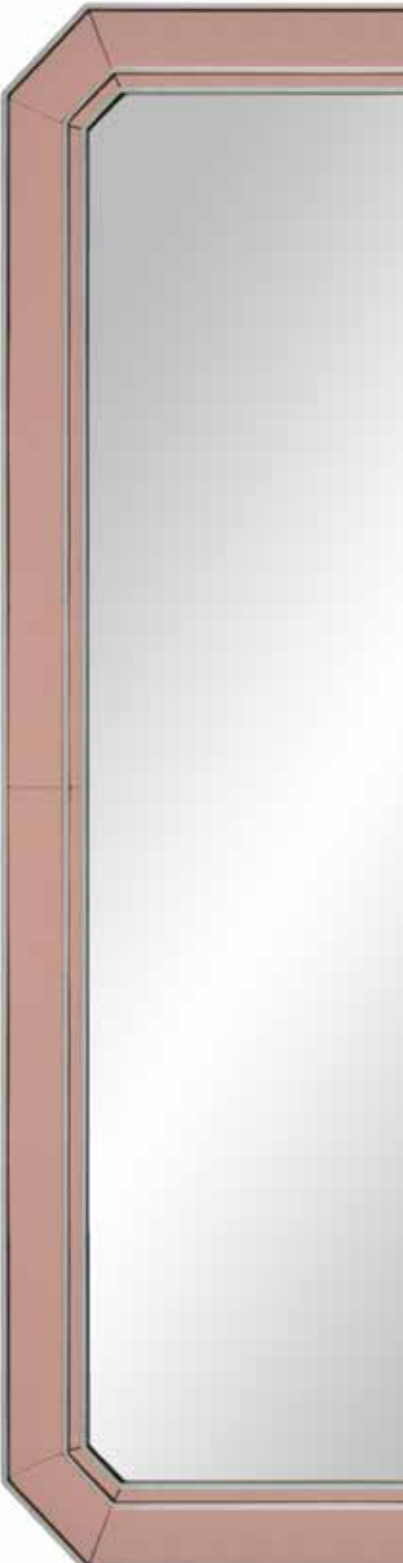

**TOOL BOX**

HAVE A HISTORIC PROPERTY OR WANT TO GIVE YOUR FRAMES AN ANTIQUED FEEL? WHY NOT WITH ANTIQUE MIRROR! SELECT ANY ANTIQUE PATTERN FROM OUR MIRROR SPECIFIER.



CLAUDE | 15039  
DESCRIPTION: QUEEN ANNE MIRROR SHOWN IN ANTIQUE MIRROR AND GOLD LEAF DETAIL



PIERRE | 15041  
DESCRIPTION: QUEEN ANNE MIRROR SHOWN IN ANTIQUE MIRROR AND MATTE BLACK DETAIL



FRANCOIS | 15045  
DESCRIPTION: QUEEN ANNE MIRROR SHOWN IN ANTIQUE MIRROR AND MATTE BLACK DETAIL

ANGELIQUE | 15043  
DESCRIPTION: QUEEN ANNE MIRROR SHOWN IN ANTIQUE MIRROR AND GOLD LEAF DETAIL





CAMILLE | 15042  
DESCRIPTION: QUEEN ANNE MIRROR SHOWN IN ANTIQUE MIRROR AND SILVER LEAF DETAIL



LOUISA | 15044  
DESCRIPTION: QUEEN ANNE MIRROR SHOWN IN ANTIQUE MIRROR AND ROSE GOLD DETAIL

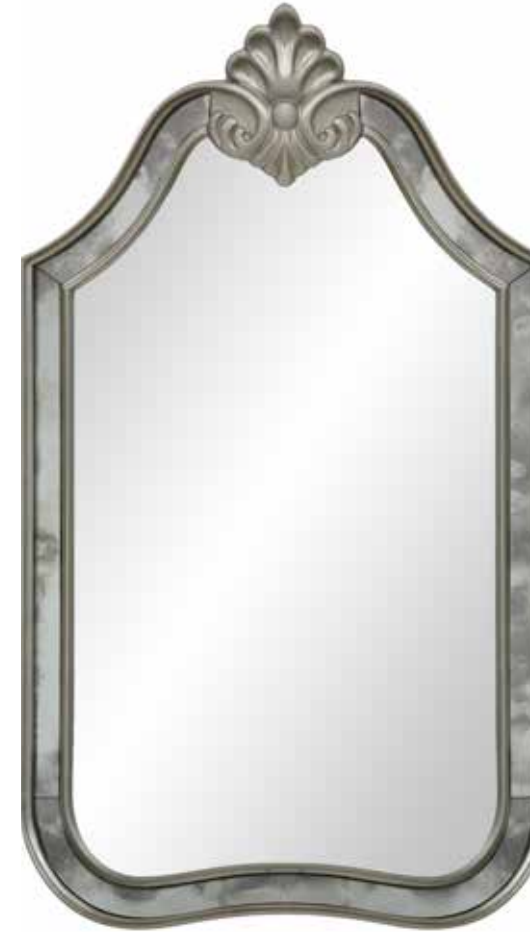

SOPHIA | 15040  
DESCRIPTION: QUEEN ANNE MIRROR SHOWN IN ANTIQUE MIRROR AND BRONZE DETAIL



GENEVIEVE | 15038  
DESCRIPTION: QUEEN ANNE MIRROR SHOWN IN ANTIQUE MIRROR AND SILVER LEAF DETAIL

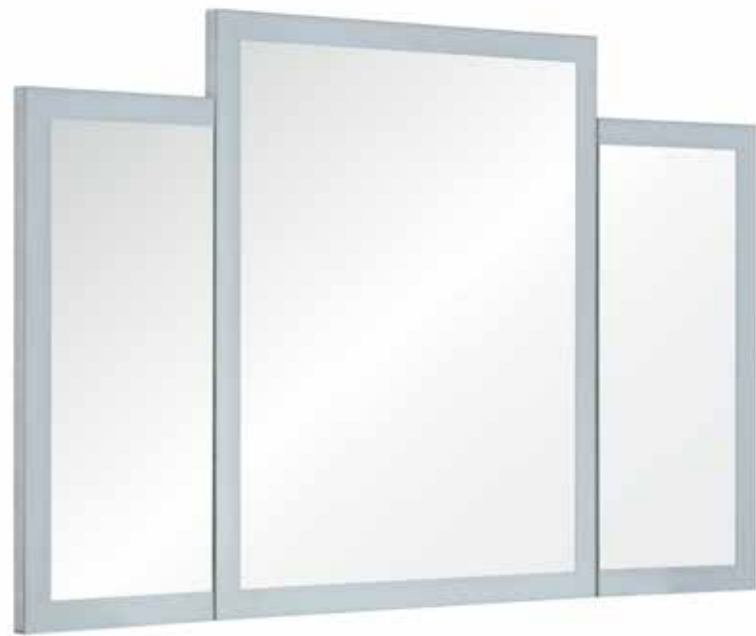

LEX | 15034  
DESCRIPTION: MODERN  
TRIFOLD SHOWN IN SILVER



LUCY | 15082  
DESCRIPTION: TRIFOLD  
ANTIQUE MIRROR FRAME



LONDON | 15010  
DESCRIPTION: TRIFOLD MIRROR  
WRAPPED IN SHAGREEN WITH  
BEVELED PANEL MIRRORS

## TOOL BOX

TURN ANY OF OUR FRAMES OR BACKLIT MIRRORS INTO A TRIFOLD OR SCREEN. PANELS CAN BE HINGED OR FIXED.

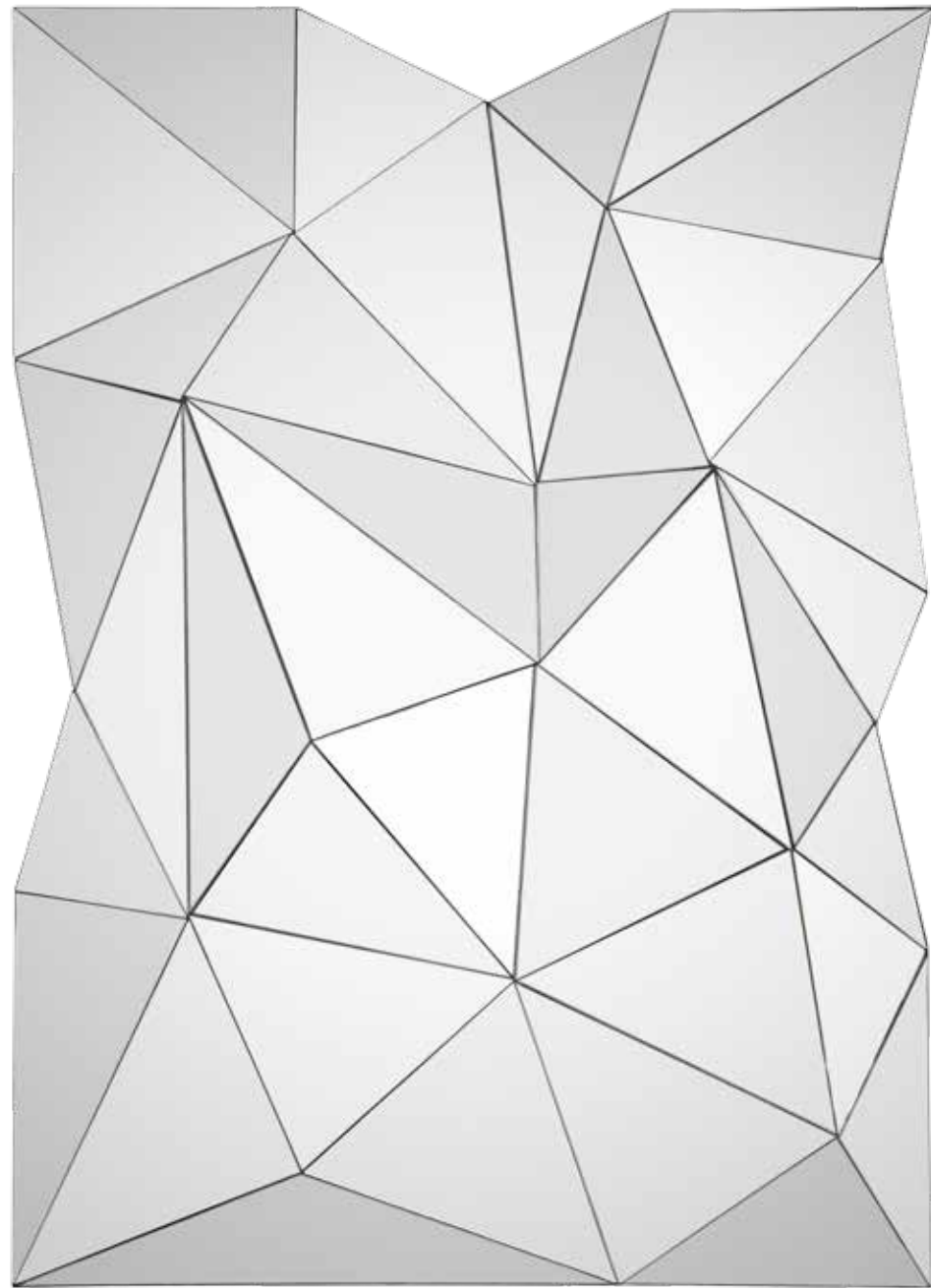

ZOEY | 15002  
DESCRIPTION: MULTI-FACETED  
THREE DIMENSIONAL MIRROR  
PANEL SHOWN IN CLEAR MIRROR

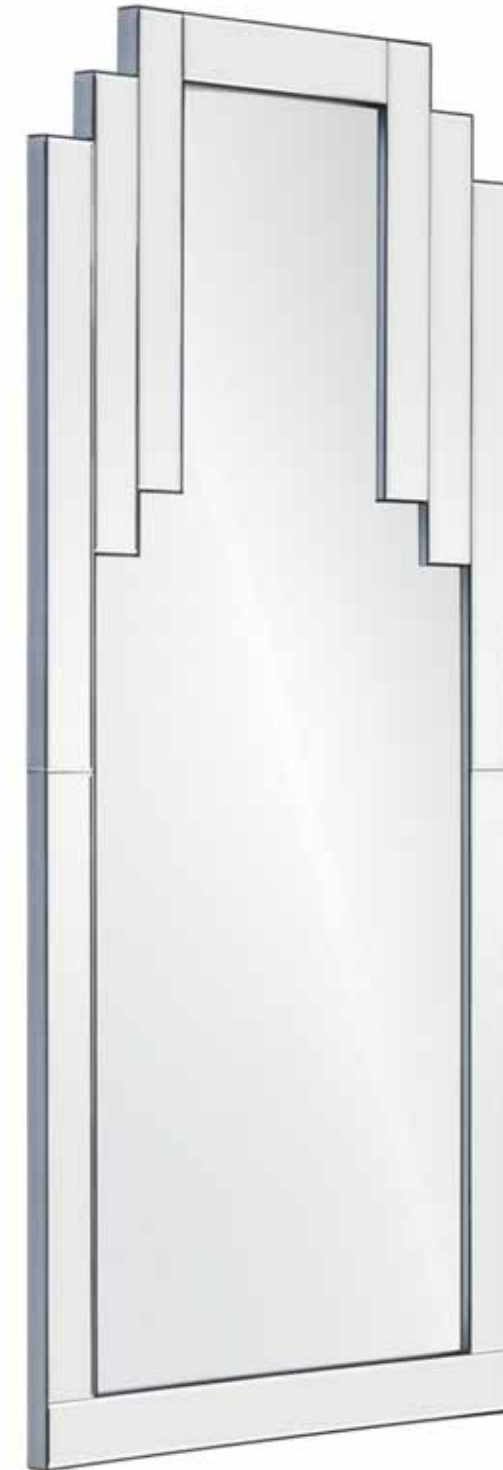
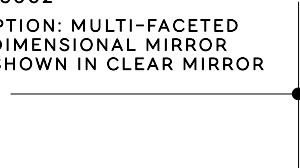

GATSBY | 15020  
DESCRIPTION: SKYSCRAPER INSPIRED  
DECORATIVE MIRROR FRAMED MIRROR  
SHOWN IN SILVER LEAF





JULIETTE | 15037  
DESCRIPTION: VENETIAN  
FRAMED MIRROR



ROMEO | 15036  
DESCRIPTION: FULL LENGTH  
VENETIAN FRAMED MIRROR

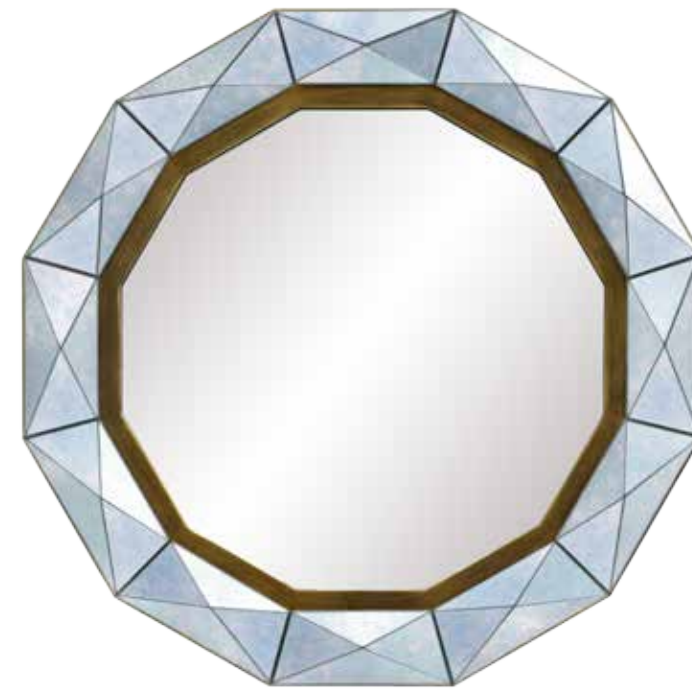

ALICIA | 15564  
DESCRIPTION: THREE DIMENSIONAL,  
MULTI-FACETED MIRROR SHOWN IN  
ANTIQUÉ MIRROR WITH BRUSHED BRONZE

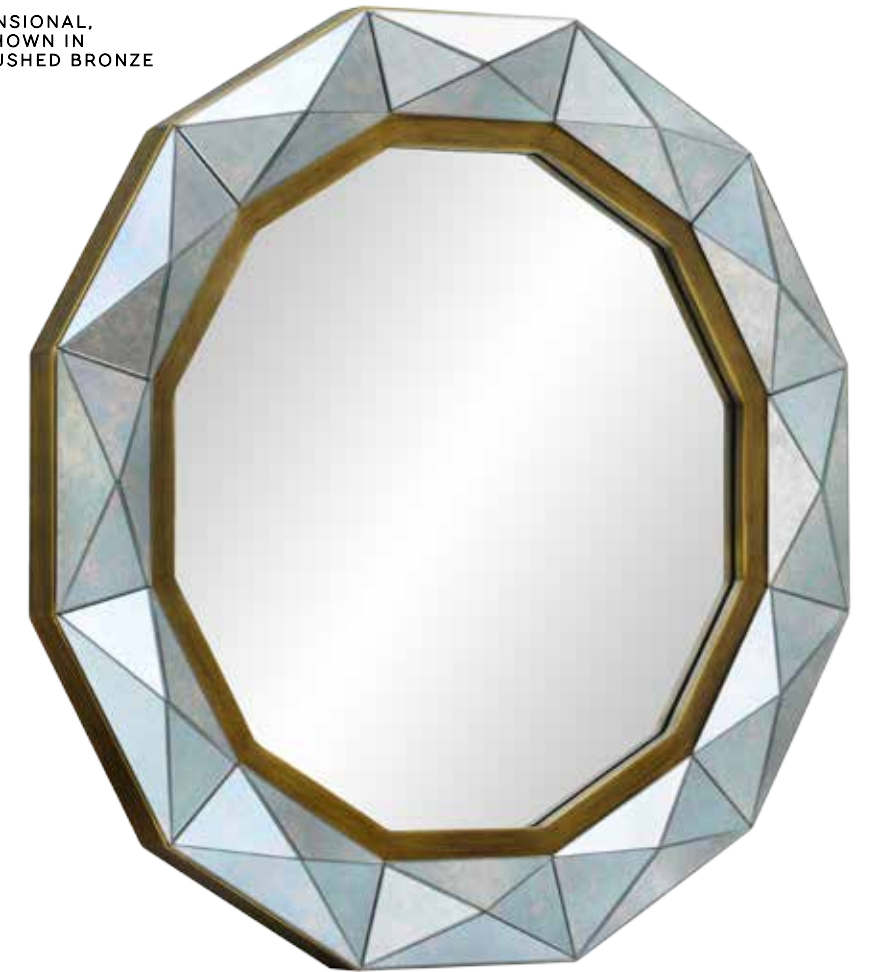



SEMME | 15586  
 DESCRIPTION: ANTIQUE MIRROR  
 WITH SCENCE SHOWN IN GOLD  
 METAL FRAME OVERLAY

# OUR PROJECTS

THE ADMIRAL HOTEL Curio and Associates in Dallas, Texas. Collection by Hilton - Mobile, Alabama. Designed by Boutique 18 honoree Ellen Tichenor, Senior Designer at Flick Mars in Dallas, Texas. Purchased by Neil Locke

Ellen designed these beautiful statement pieces throughout the public space with Mirror Image antique mirror pattern, Pauline.





KEY | 15600  
DESCRIPTION: FRAMED  
DECORATIVE KEY HOLE MIRROR  
SHOWN IN ANTIQUED BRASS  
AND GOLD PLATED DETAIL

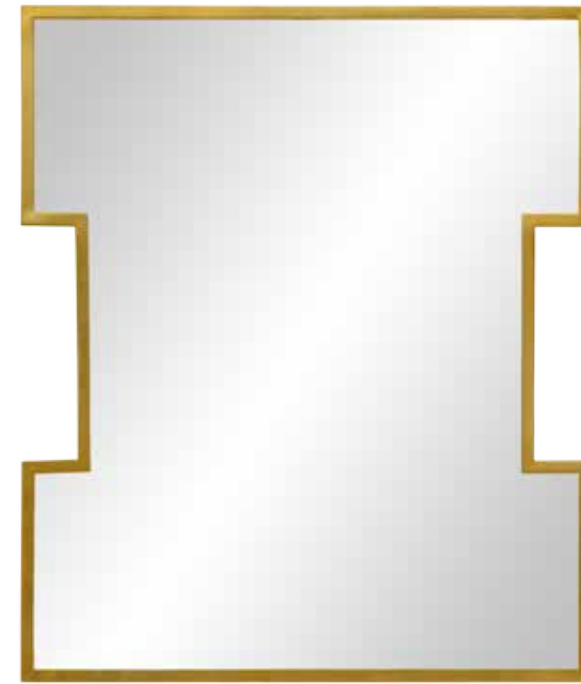

CAESAR | 15571  
DESCRIPTION: DECORATIVE  
MIRROR SHOWN IN GOLD LEAF

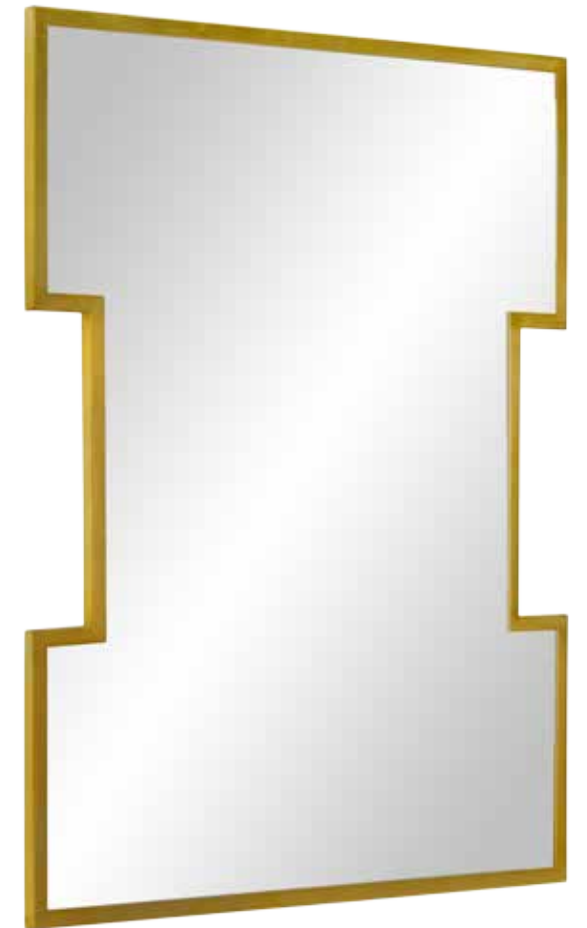

JOSEPHINE | 15590  
DESCRIPTION: THREE PANEL DECORATIVE  
FRAME SHOWN IN GOLD LEAF



WINSTON | 15572  
DESCRIPTION:  
DECORATIVE MIRROR  
SHOWN IN GOLD LEAF

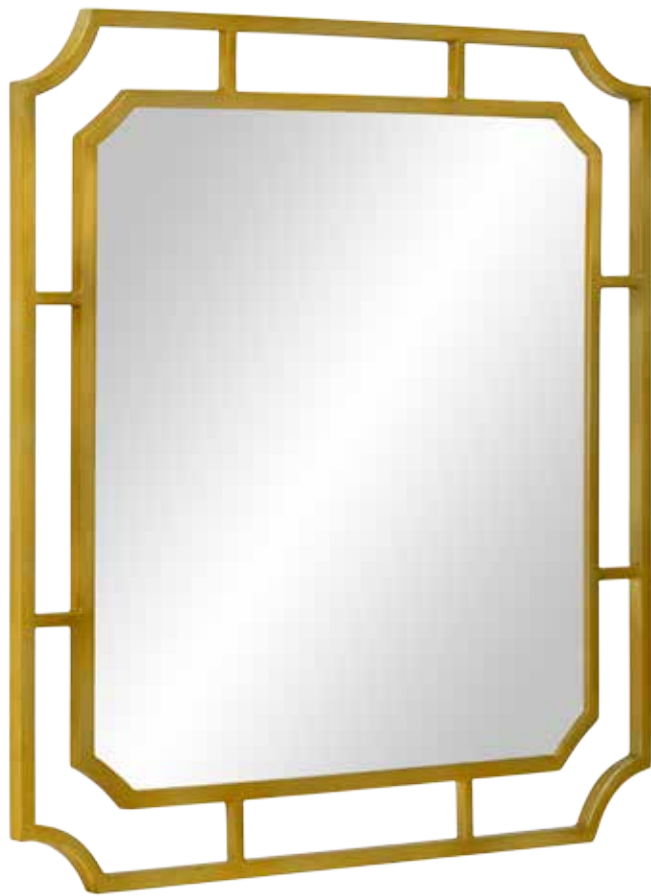

HARLEM | 15609  
DESCRIPTION:  
DECORATIVE MIRROR  
SHOWN IN GOLD LEAF



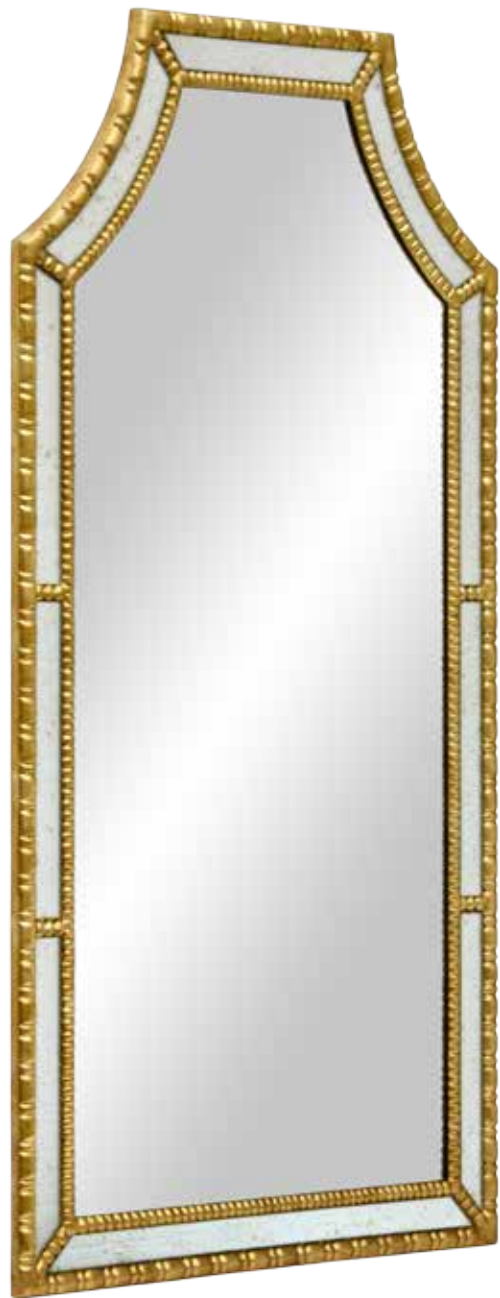

GAGE | 15535  
DESCRIPTION: FRAMED MIRROR  
TILES SHOWN IN GOLD LEAF

DIONNE | 15578  
DESCRIPTION:  
DECORATIVE MIRROR  
SHOWN IN GOLD LEAF  
AND ANTIQUE MIRROR



CHER | 15577  
DESCRIPTION:  
DECORATIVE OVAL  
SHOWN IN GOLD LEAF  
AND ANTIQUE MIRROR



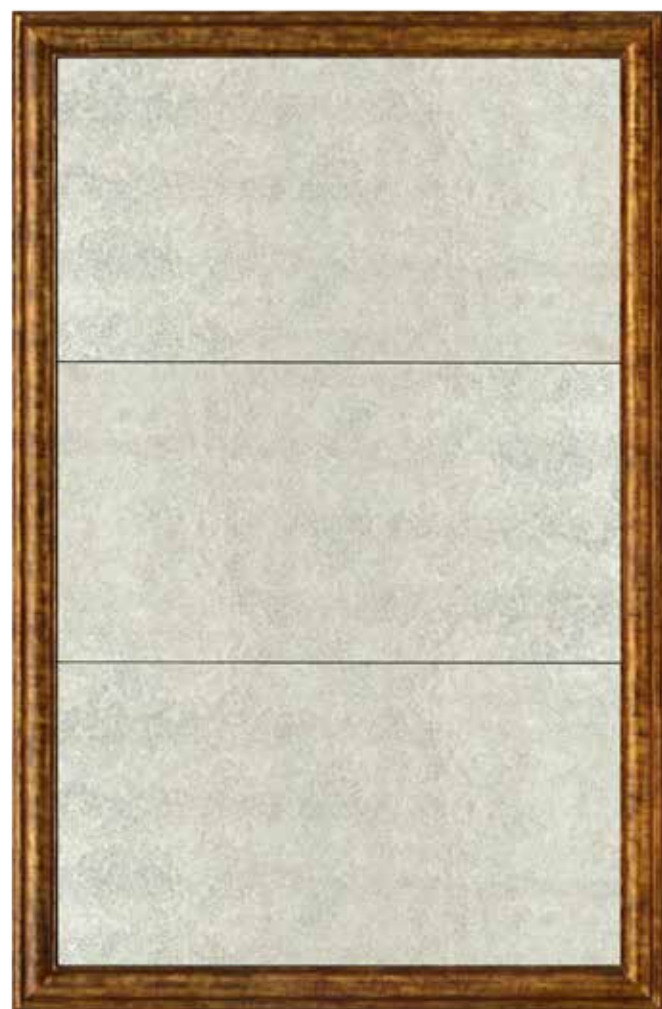

KYLE | 15592  
DESCRIPTION: FRAMED ANTIQUE  
MIRROR PANELS SHOWN IN  
DISTRESSED BRONZE



KATIE | 15593  
DESCRIPTION: FRAMED ANTIQUE  
MIRROR SHOWN IN DISTRESSED  
BRONZE



TAI | 15562  
DESCRIPTION: DECORATIVE FRAME  
SHOWN IN FAUX BURLWOOD WITH  
MATTE BLACK DETAIL





MEL | 15583  
DESCRIPTION: DECORATIVE FLOATER  
FRAME SHOWN IN WALNUT WITH  
WHITE REVEAL

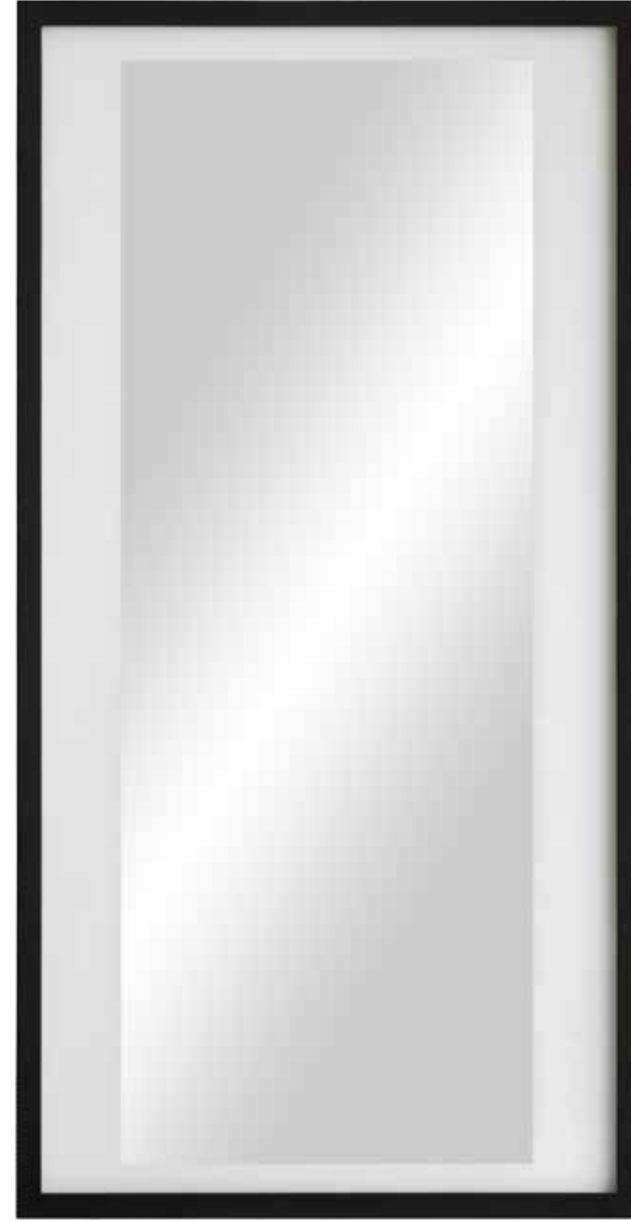

CLAIRE | 15563  
DESCRIPTION: DECORATIVE  
FLOATER FRAME SHOWN IN  
BLACK WITH WHITE REVEAL

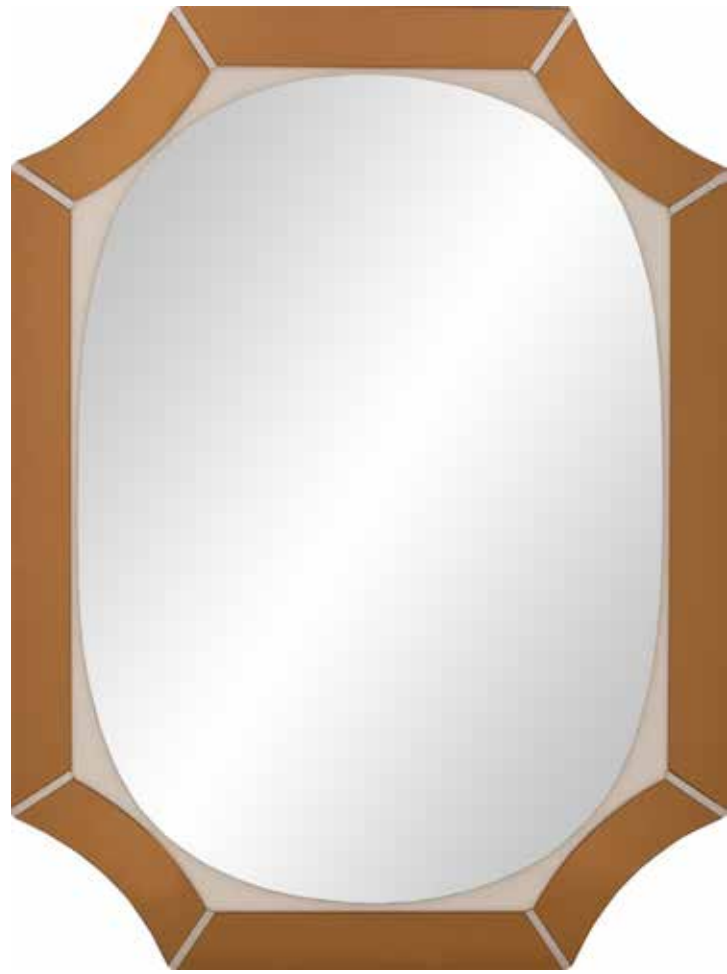

MARLEY | 15504  
DESCRIPTION: DECORATIVE MIRROR  
FRAME MIRROR SHOWN IN WHITE  
LACQUER AND BRONZE MIRROR

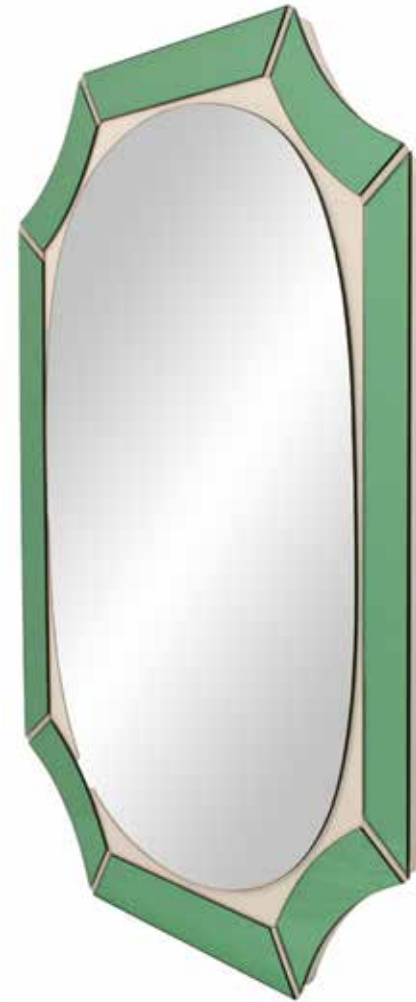

SHILOH | 15503  
DESCRIPTION: DECORATIVE  
MIRROR FRAME MIRROR  
SHOWN IN WHITE LACQUER  
AND JADE MIRROR

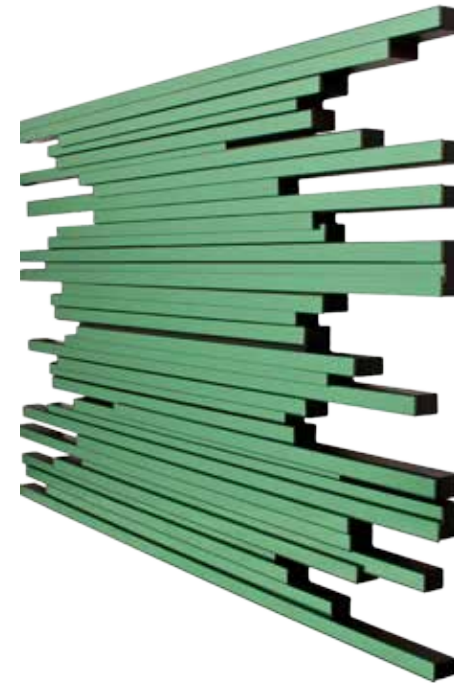

FALL | 15508  
DESCRIPTION: THREE  
DIMENSIONAL STACKED MIRROR  
SHOWN IN BRONZE MIRROR



SPRING | 15507  
DESCRIPTION: THREE  
DIMENSIONAL STACKED MIRROR  
SHOWN IN JADE MIRROR



WINTER | 15509  
DESCRIPTION: THREE  
DIMENSIONAL STACKED MIRROR  
SHOWN IN CLEAR, FROSTED AND  
DIAMOND MIRROR



FRANCIS | 15585  
 DESCRIPTION: TRADITIONAL  
 DECORATIVE FRAME SHOWN IN  
 ANTIQUE GOLD WITH CLEAR AND  
 ANTIQUE MIRROR PANELS



CHAZ | 15534  
 DESCRIPTION:  
 DECORATIVE OVAL SHOWN  
 IN WHITE LACQUER WITH  
 ANTIQUE MIRROR PANELS

# & S M O K E M I R R O R

Request our latest mirror specifier from your local rep or by emailing [info@mirrorimageinc.com](mailto:info@mirrorimageinc.com) for our selection of antique mirror patterns and color mirrors. Other antique or color mirrors may be available. Inquire directly by emailing [info@mirrorimageinc.com](mailto:info@mirrorimageinc.com).

## SHAPE

Mirror Image can customize almost any shape or size to make the mirror into a custom tile pattern or create abstract shapes. Email your shape to [info@mirrorimageinc.com](mailto:info@mirrorimageinc.com).

## THICKNESS

Our antique and color mirror comes standard as 5 millimeter thick. Laminated versions of any of our mirrors can increase the thickness up to 10 millimeters.

## SIZE

We recommend that any sheet size ordered does not exceed 24 square feet for safe shipping.

## BACKING

We can add ANSI vinyl safety backing to the back of all of our mirrors. Please note that if mirror is to adhere directly to a wall, glue will replace the need for safety backing.

## INSTALLATION

We recommend using Gunther Premier Mirror Mastic for unframed mirror panels being adhered directly to a wall.

## USES

Any of our mirrors can be placed into a frame, used as a frame, cut into large sheets, or small wall tiles.

## EDGEWORK

Specify your edge – polish, flat polish, pencil or bevel.



GOLD

BRONZE

AMETHYST



JADE



AQUAMARINE



DIAMOND



ROSE GOLD

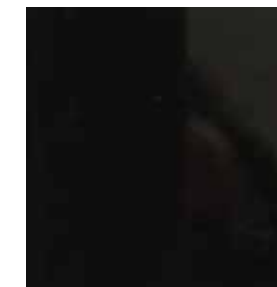

ONYX



QUARTZ



RUTH



GUSTAV



PAULINE

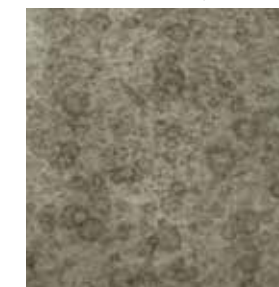

WALTER

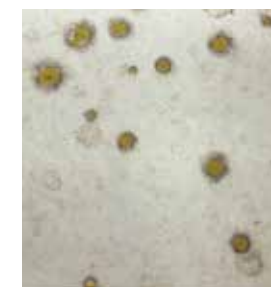

MIKAH



JOANNA



IRVING



PAIGE



JESSE



TAYLA



WYLLIS



MAX



BELLA | 15033  
DESCRIPTION: FRAMELESS  
MIRROR WITH DECORATIVE  
CYLINDERS SHOWN IN  
SILVER LEAF



QUINN | 15032  
DESCRIPTION: FRAMELESS  
MIRROR WITH DECORATIVE  
CYLINDERS SHOWN IN  
GOLD LEAF

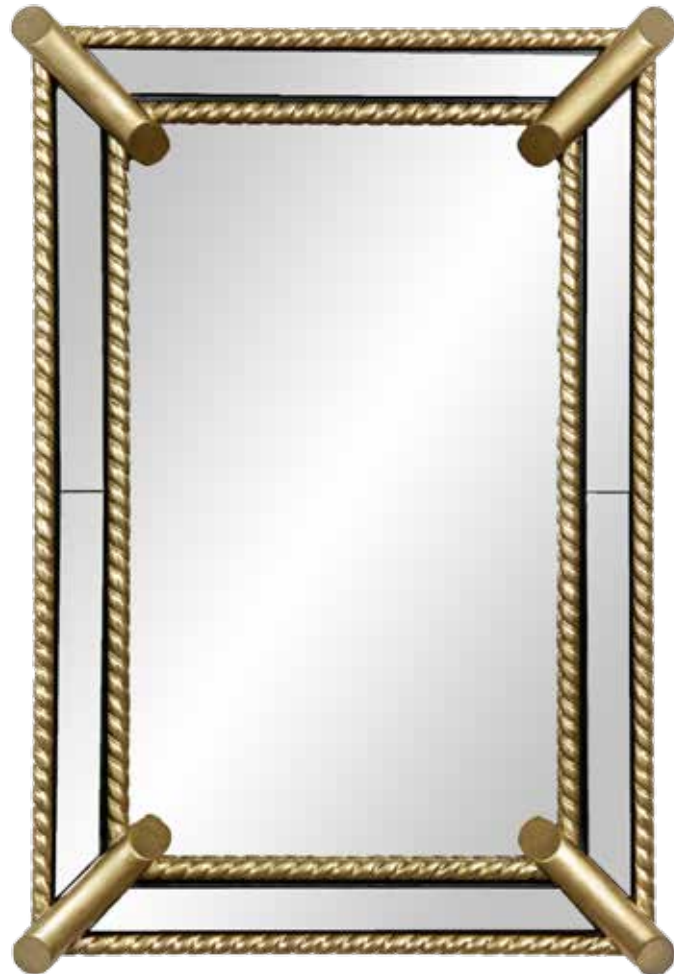

QUINN | 15031  
DESCRIPTION: FRAMELESS  
MIRROR WITH DECORATIVE  
CYLINDERS SHOWN IN BRONZE  
WITH ANTIQUE MIRROR

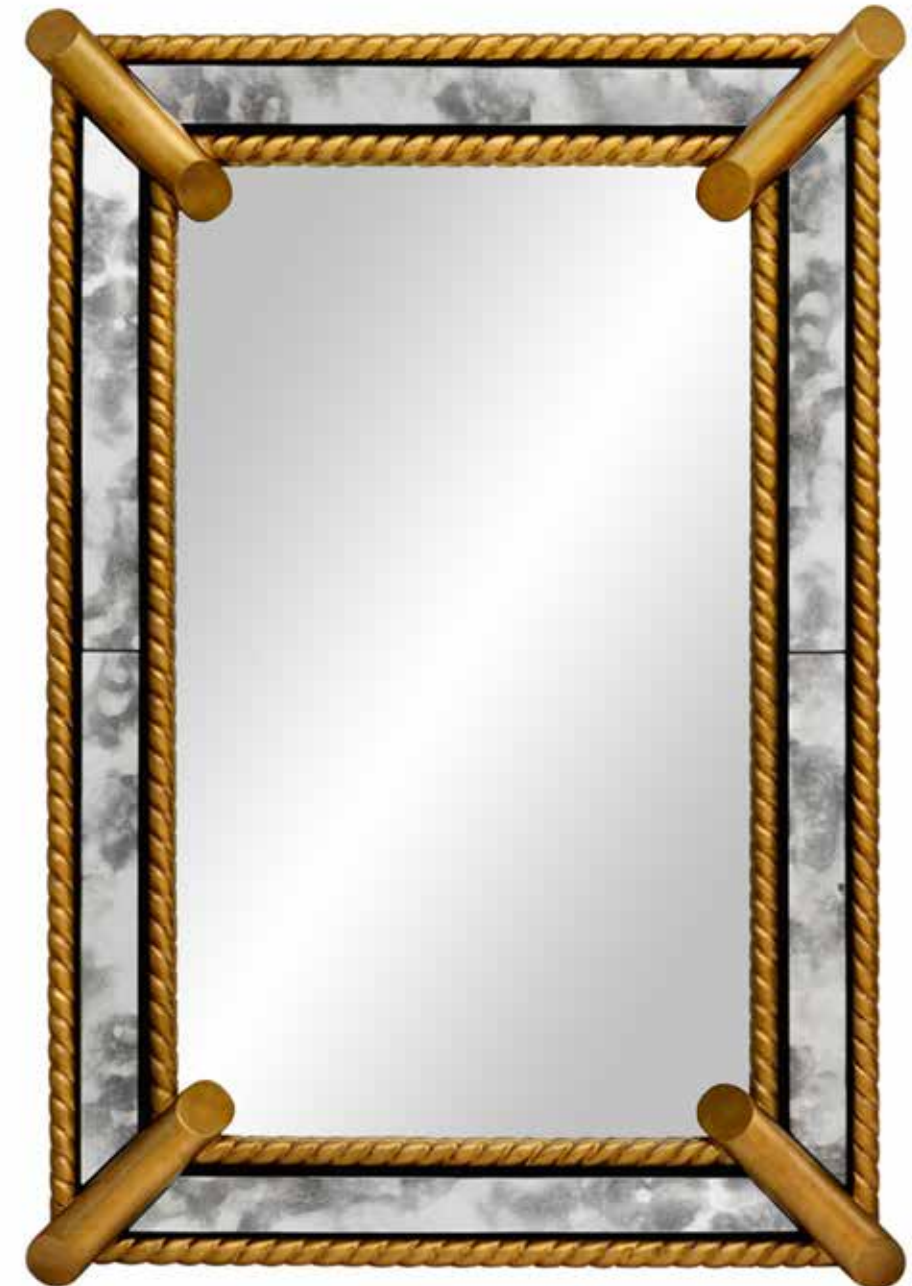



ELLA | 15051  
DESCRIPTION: QUEEN ANNE FLOATER FRAME SHOWN IN SILVER LEAF

EMMA | 15056  
DESCRIPTION: QUEEN ANNE FLOATER FRAME SHOWN IN SILVER LEAF

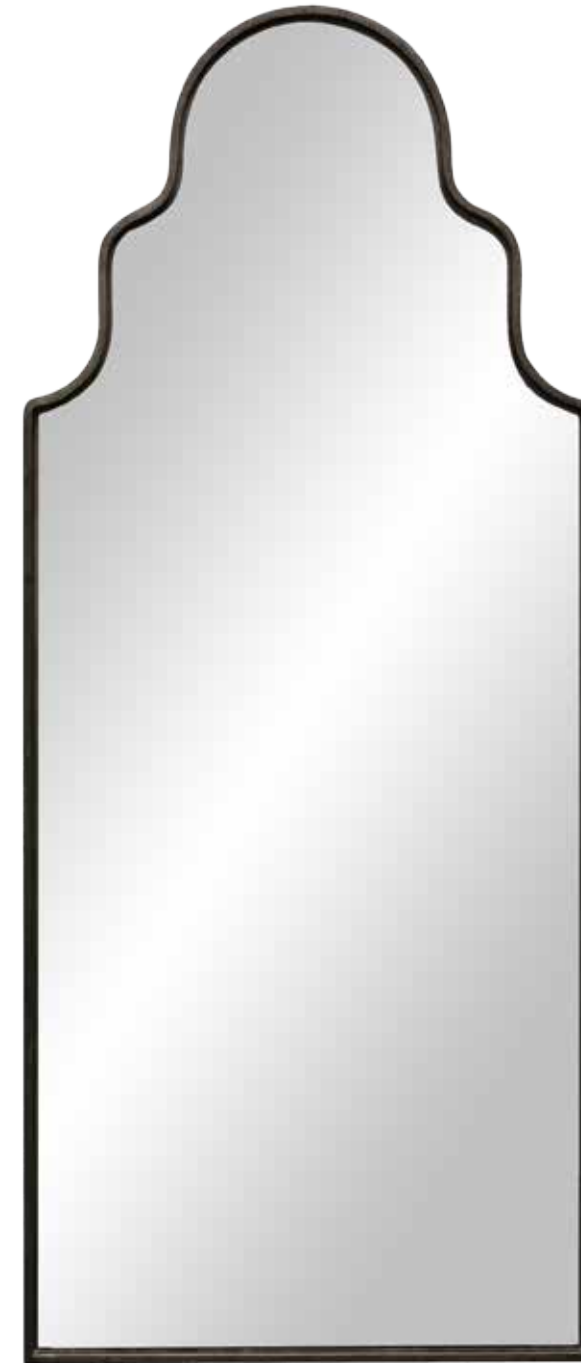

SOPHIE: 15059  
DESCRIPTION: QUEEN ANNE FLOATER FRAME SHOWN IN CHARCOAL



MASON | 15053  
DESCRIPTION: QUEEN ANNE  
FLOATER FRAME SHOWN IN BRONZE

CHARLIE | 15058  
DESCRIPTION: QUEEN  
ANNE FLOATER FRAME  
SHOWN IN BRONZE



JUDE | 15052  
DESCRIPTION: QUEEN  
ANNE FLOATER FRAME  
SHOWN IN GOLD LEAF



HARPER | 15057  
DESCRIPTION: QUEEN  
ANNE FLOATER FRAME  
SHOWN IN GOLD LEAF

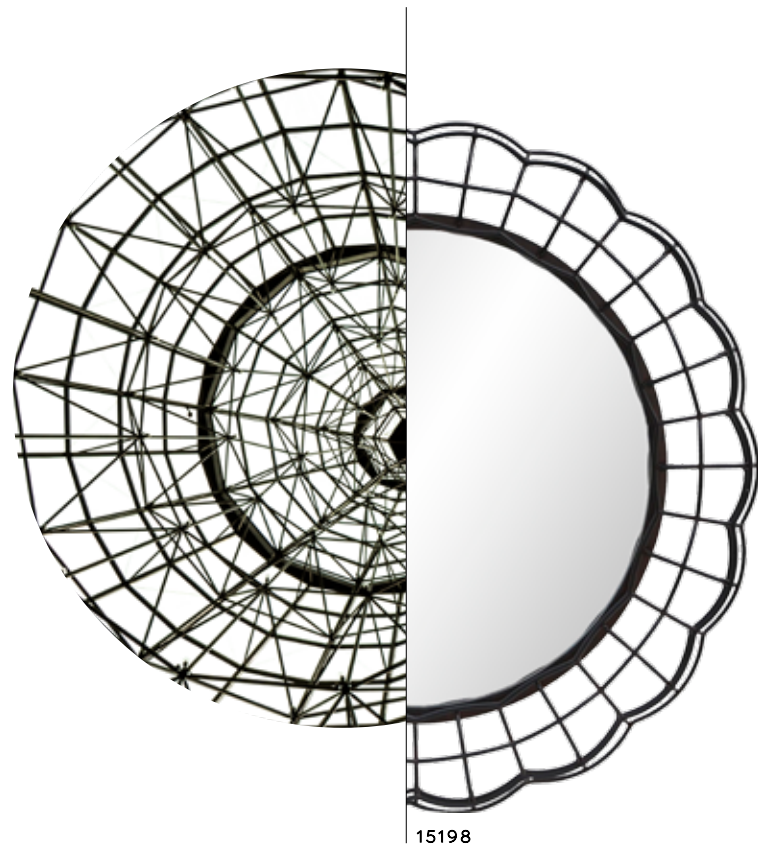

15198

# METAL WORK

Our craftsmanship and finishes of our metal pieces are exceptional. We offer a wide array of finishes ranging from powder coated or painted, which are less costly, to stunning plated finishes. For more information, please email [info@mirrorimageinc.com](mailto:info@mirrorimageinc.com).



NELLY | 15161  
DESCRIPTION: MINIMALIST METAL FLOATER FRAME WITH FLOATING MIRROR SHOWN IN POLISHED BRASS



BROOKLYN | 15189  
DESCRIPTION: OCTAGONAL MINIMALIST METAL FRAME SHOWN IN POLISHED BLACK NICKEL

**TOOL BOX**  
CREATE ANY CUSTOM GRID WITH ANY OF OUR ANTIQUE OR COLOR MIRROR. CUSTOMIZE THE FRAME FINISH TO YOUR SPECIFICATIONS.



**VEGA | 75004**  
DESCRIPTION: METAL FRAME SHOWN IN BRUSHED BRONZE WITH ROSE GOLD AND CLEAR MIRROR PANELS

**GALAXY | 15559**  
DESCRIPTION: SHOWN IN POLISHED STAINLESS STEEL, BRASS AND BLACK NICKEL FRAMES, CLEAR AND BRONZE MIRROR





PLUTO | 15090  
DESCRIPTION: MINIMALIST  
METAL FRAME SHOWN IN  
SILVER FINISH



SATURN | 15091  
DESCRIPTION: MINIMALIST  
METAL FRAME SHOWN IN  
BRONZE



MOON | 15089  
DESCRIPTION: MINIMALIST METAL  
FRAME SHOWN IN EBONY



VENUS | 15663  
DESCRIPTION: MINIMALIST METAL  
FRAME SHOWN IN POLISHED COPPER

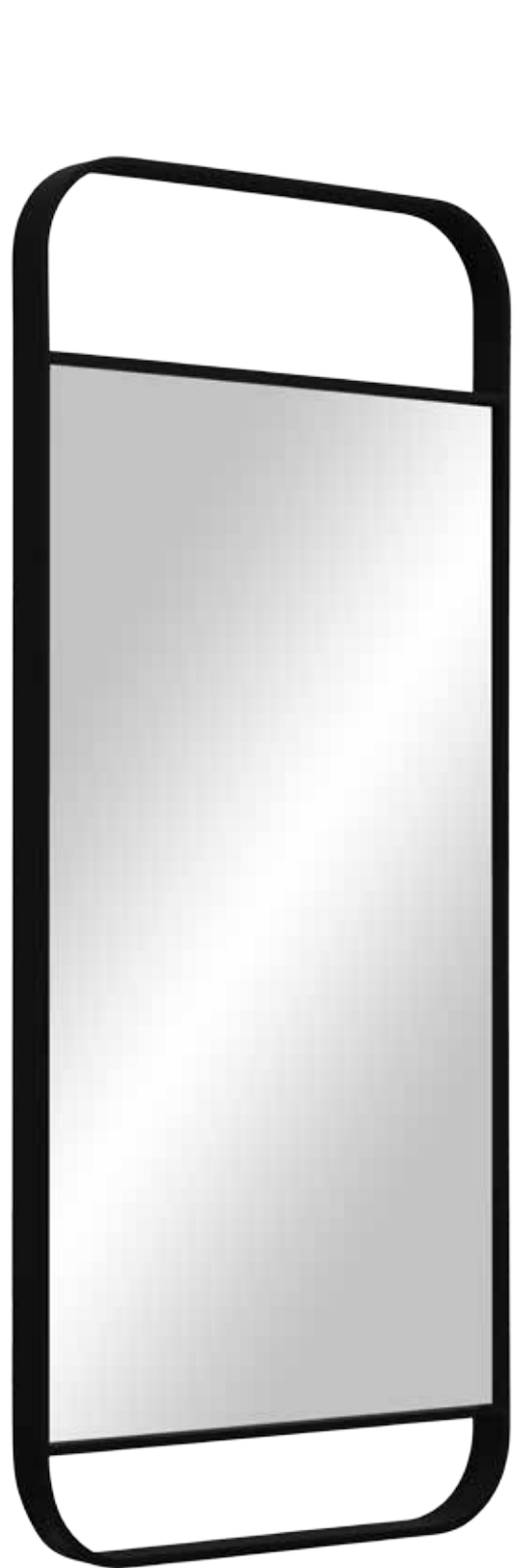

BROOKLYN | 15189  
DESCRIPTION: OCTAGONAL  
MINIMALIST METAL FRAME SHOWN  
IN POLISHED BLACK NICKEL

PLANKTON | 15544  
DESCRIPTION: DECORATIVE METAL  
FRAME SHOWN IN MATTE BLACK

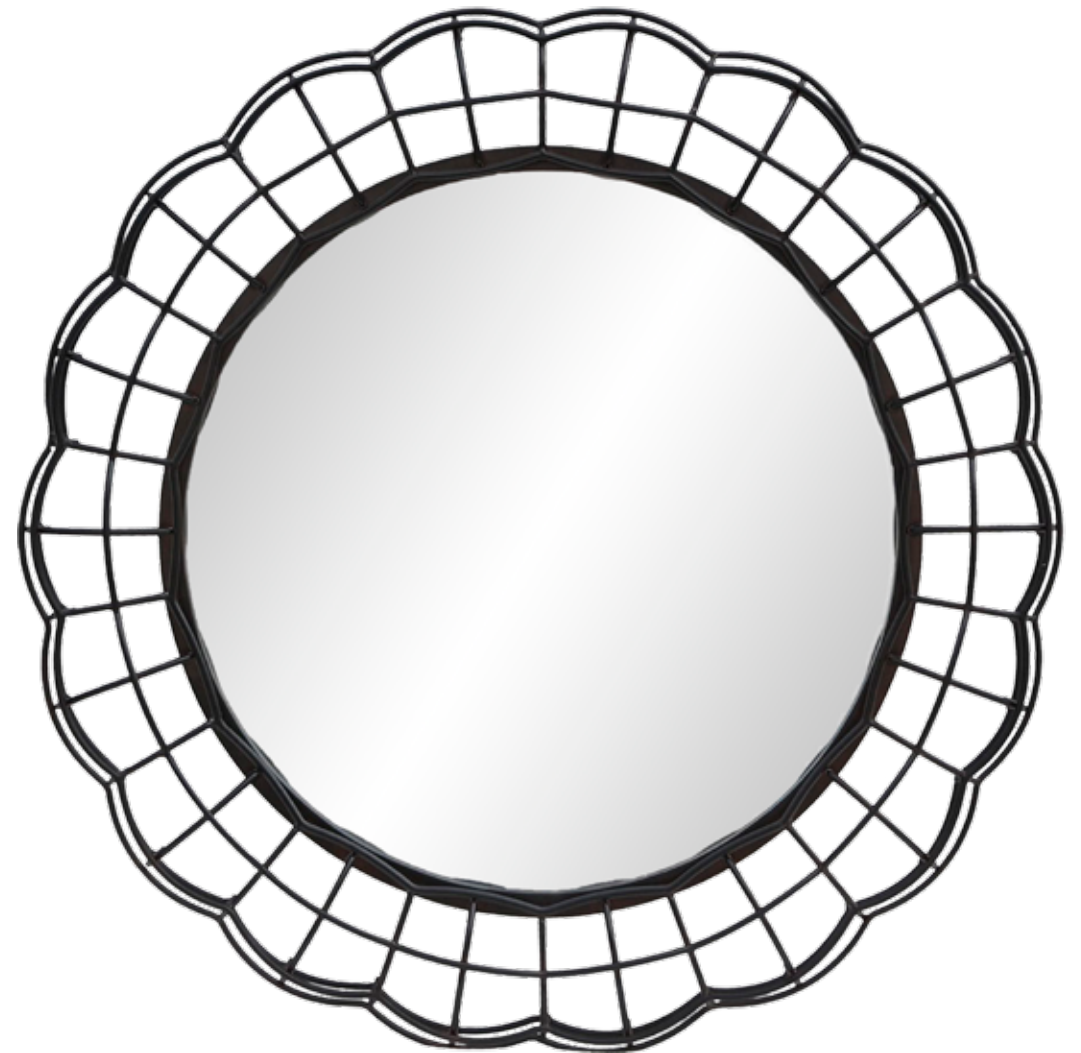

SKIPPER | 15198  
DESCRIPTION:  
DECORATIVE METAL  
FRAME SHOWN IN EBONY

PUMBA | 15671  
DESCRIPTION: MINIMALIST METAL  
FRAME SHOWN IN MATTE BLACK

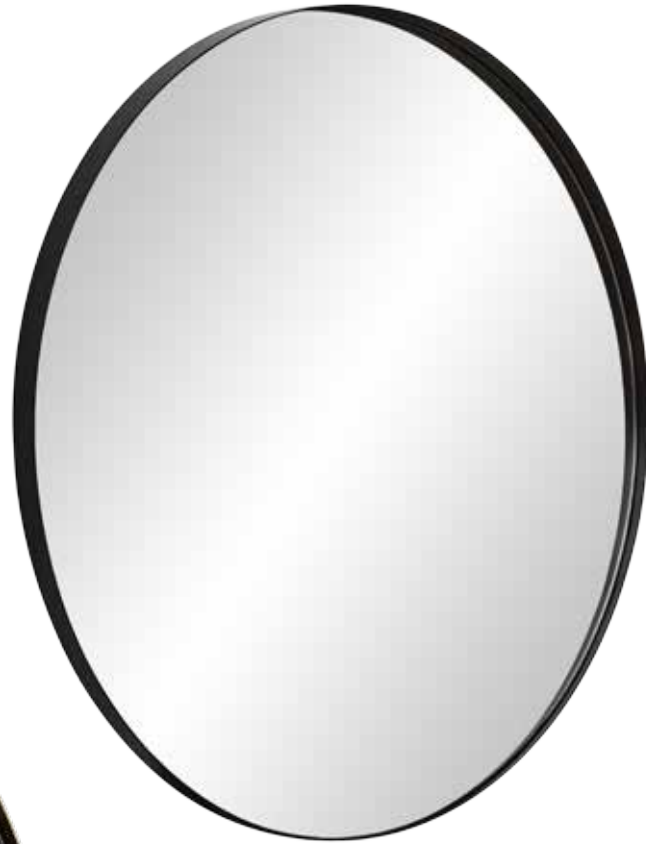

SIMONE | 15183  
DESCRIPTION: OVAL METAL  
FRAME WITH REVEAL.  
SHOWN IN BRASS

TUCKER | 15182  
DESCRIPTION: DUAL PANEL  
METAL FRAME SHOWN IN  
BRUSHED BRASS

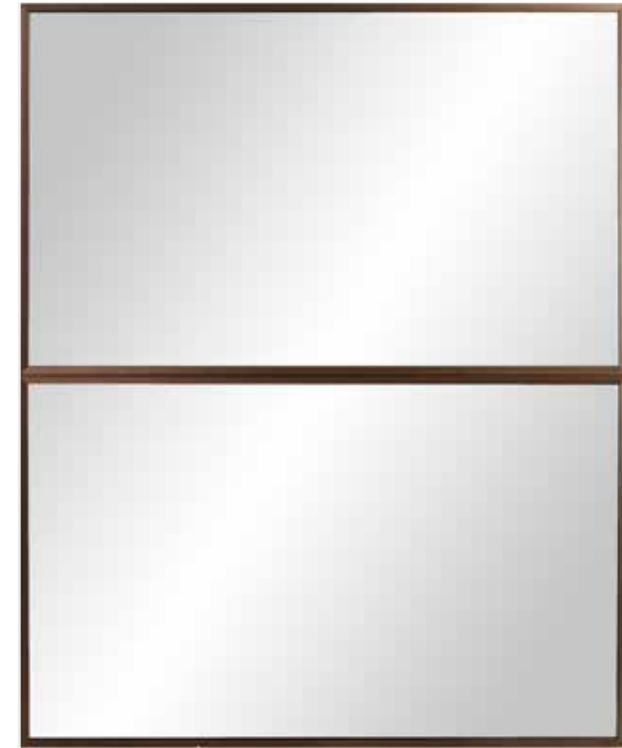

KNOX | 15162  
DESCRIPTION: METAL  
FRAME WITH MIRROR  
PANELS AND REVEAL  
SHOWN IN BRASS







MONROE | 15552  
DESCRIPTION: DECORATIVE  
FRAME WITH MULTIPLE  
PANELS BY V-GROOVE  
SHOWN IN ANTIQUE SILVER



VIVIENNE | 15584  
DESCRIPTION: DECORATIVE  
PANELED FRAME SHOWN IN  
SILVER LEAF

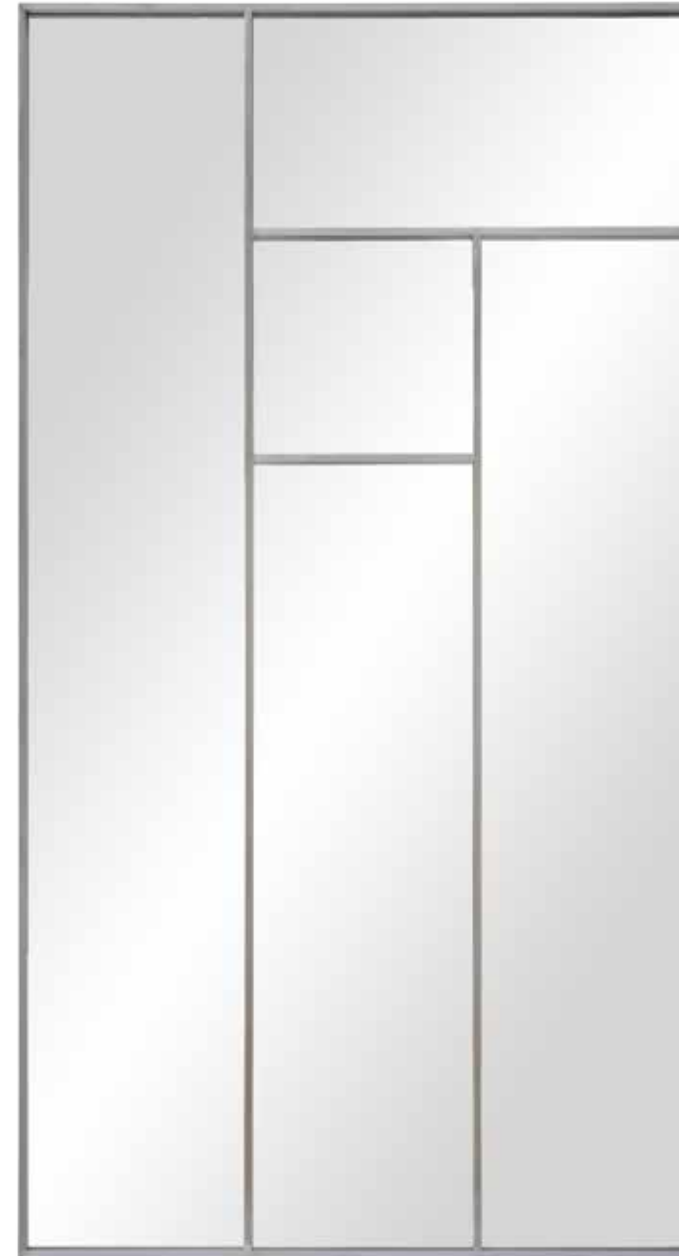



HUDSON | 15532  
DESCRIPTION: MINIMALIST  
FLOATER FRAME WITH  
V-GROOVE DETAIL ON MIRROR  
SHOWN IN GOLD LEAF



NELLY | 15161  
DESCRIPTION: MINIMALIST METAL  
FLOATER FRAME WITH FLOATING  
MIRROR SHOWN IN POLISHED BRASS



CHANDLER | 15617  
DESCRIPTION: MINIMALIST METAL  
FRAME SHOWN IN POLISHED BRASS



# MARITIME INSPIRATION

Whether your property is on a beach or lake, your inspiration may lend to nautical accessories. Look no further than Mirror Image Hospitality as your resource.



COMPASS | 15595  
DESCRIPTION: FISHERMAN'S  
ROPE WRAPPED FRAME



KNOTS | 15077  
DESCRIPTION: SUSPENDED  
MIRROR SHOWN IN DEEP  
SEA BLUE



DIANE | 15046  
DESCRIPTION: DECORATIVE MIRROR  
SHOWN IN DISTRESSED DRIFTWOOD



SUNNY | 15112  
DESCRIPTION: DECORATIVE MIRROR  
SHOWN IN GOLD LEAF WITH  
DISTRESSED DRIFTWOOD INSET



KELLY | 15154  
DESCRIPTION: DECORATIVE MIRROR  
SHOWN IN DISTRESSED OAK



BEDE | 15153  
DESCRIPTION: DECORATIVE MIRROR  
SHOWN IN DISTRESSED WALNUT



KAYA | 15048  
DESCRIPTION: DECORATIVE MIRROR  
SHOWN IN SPLATTERED FINISH



AVANI | 15050  
DESCRIPTION: DECORATIVE MIRROR  
SHOWN IN SPLATTERED FINISH



DANE | 15049  
DESCRIPTION: DECORATIVE  
FRAMED MIRROR SHOWN IN  
DISTRESSED FINISH

WAVERLY | 15047  
DESCRIPTION: DECORATIVE FRAMED  
MIRROR SHOWN IN DISTRESSED FINISH

COPA | 15520  
DESCRIPTION: CORAL DECORATIVE  
FRAMED MIRROR SHOWN IN HIGH  
GLOSS BLACK LACQUER

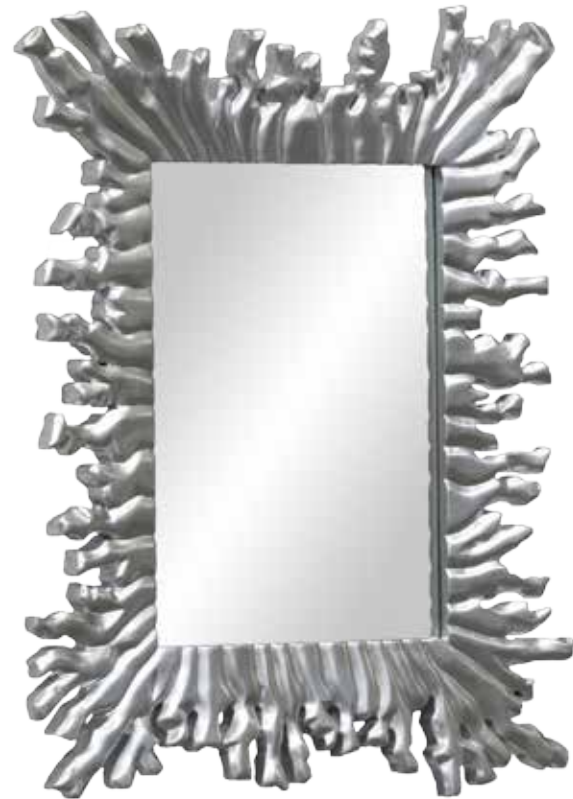

CABANA | 15521  
DESCRIPTION: CORAL DECORATIVE  
FRAMED MIRROR SHOWN IN HIGH  
GLOSS SILVER LACQUER

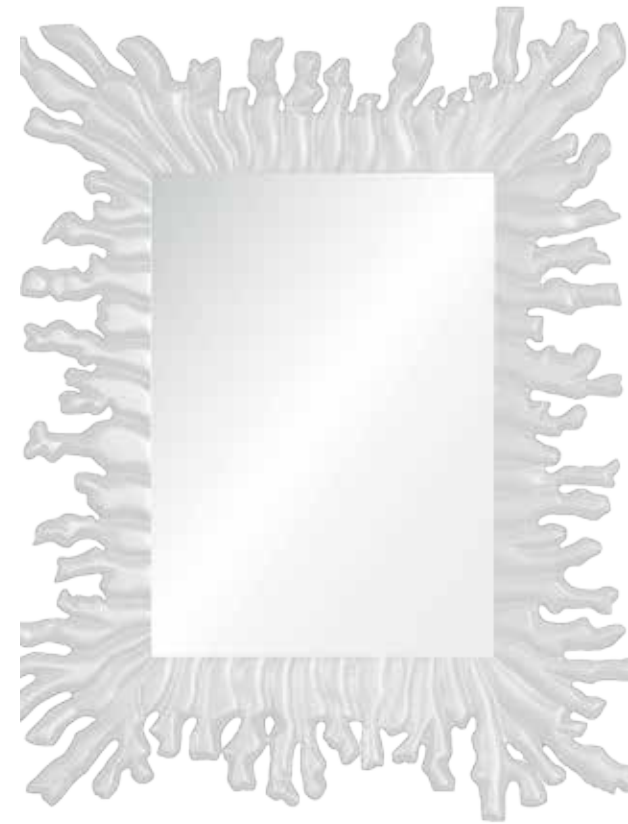

BERMUDA | 15522  
DESCRIPTION: CORAL DECORATIVE  
FRAMED MIRROR SHOWN IN HIGH  
GLOSS WHITE LACQUER

MONTEGO | 15523  
DESCRIPTION: CORAL DECORATIVE  
FRAMED MIRROR SHOWN IN HIGH  
GLOSS SALMON LACQUER

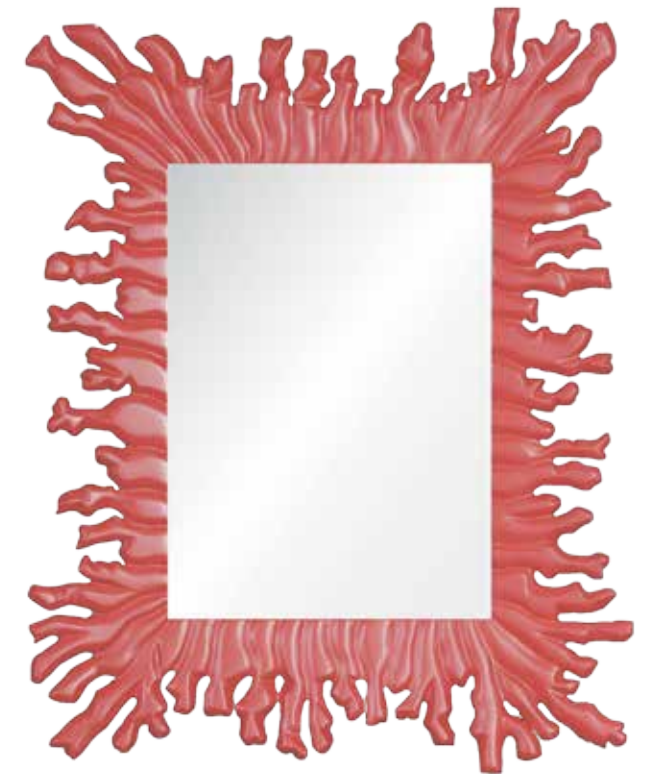



NAUTILUS | 15176  
DESCRIPTION: METAL FRAME WITH  
COUNTERSUNK RIVET SCREWS SHOWN  
IN BRUSHED STAINLESS STEEL



CAPTAIN | 15551  
DESCRIPTION: METAL FRAME WITH  
COUNTERSUNK RIVET SCREWS  
SHOWN IN PLATED BRASS



NEMO | 15553  
DESCRIPTION: DECORATIVE  
FRAME SHOWN IN  
CHAMPAGNE SILVER



TRITON | 15166  
DESCRIPTION: OVAL DECORATIVE  
FRAME SHOWN IN MATTE BLACK  
AND ANTIQUE GOLD





MADDOX | 15028  
DESCRIPTION: CIRCULAR  
DECORATIVE MIRROR WITH  
SHELF SHOWN IN GOLD LEAF

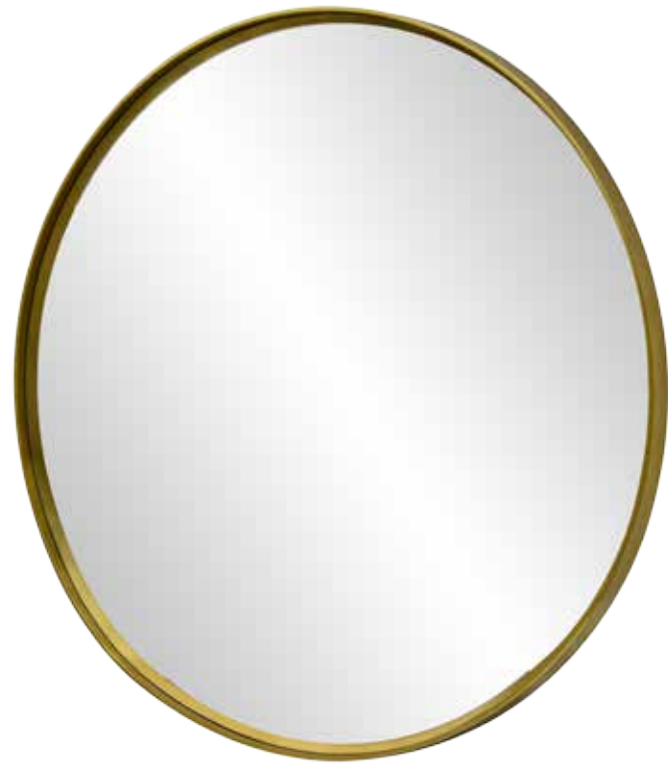

PAX | 15575  
DESCRIPTION: DECORATIVE  
MIRROR WITH MINIMALIST  
FRAME SHOWN IN GOLD LEAF



DOLAH | 15576  
DESCRIPTON: BAMBOO  
INSPIRED FRAME SHOWN  
IN ANTIQUE SILVER



THOMAS | 15187  
DESCRIPTION: DECORATIVE  
FRAME SHOWN IN EBONY  
AND SILVER LEAF



COCO | 20092  
DESCRIPTION:  
DECORATIVE FRAME  
SHOWN IN EBONY



CHAINS | 15657  
DESCRIPTION: DECORATIVE  
FRAME WITH CHROME  
DETAIL SHOWN IN EBONY



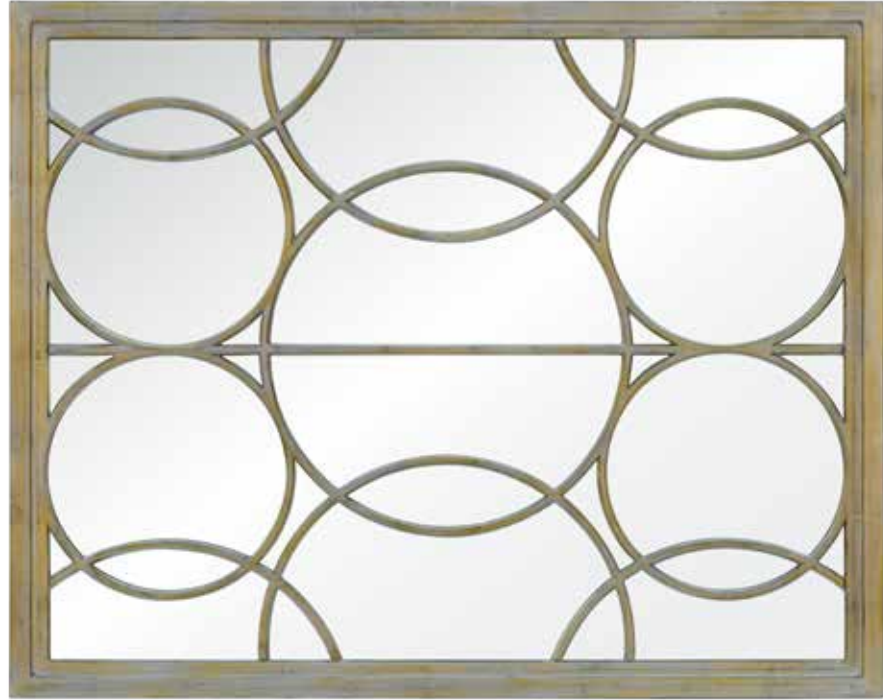

EMERSON | 15566  
DESCRIPTION: DECORATIVE  
FRAME WITH CIRCULAR OVERLAY  
SHOWN IN ANTIQUED SILVER



STELLA | 15005  
DESCRIPTION: DECORATIVE  
MIRROR SHOWN IN EBONY AND  
CHAMPAGNE SILVER

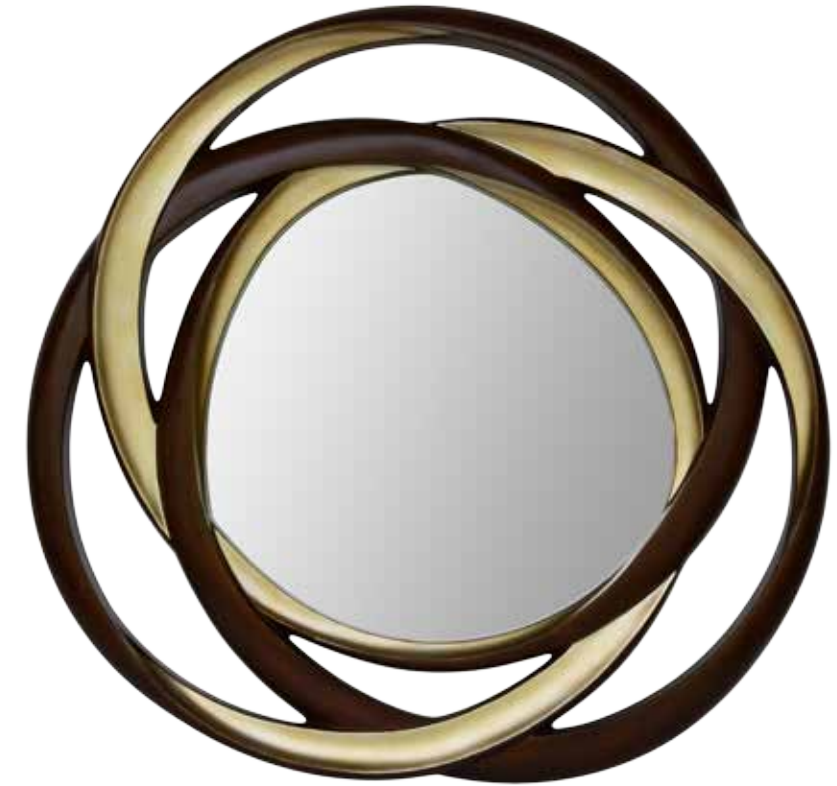

LUNA | 15678  
DESCRIPTION: DECORATIVE  
MIRROR SHOWN IN DARK WALNUT  
AND CHAMPAGNE SILVER



MILA | 15659  
DESCRIPTION: DECORATIVE FRAME  
SHOWN IN CHAMPAGNE SILVER



MICHAEL | 15658  
DESCRIPTION: VINYL  
WRAPPED FRAME SHOWN  
IN CHAMPAGNE SILVER AND  
SILVER LEAF ACCENTS

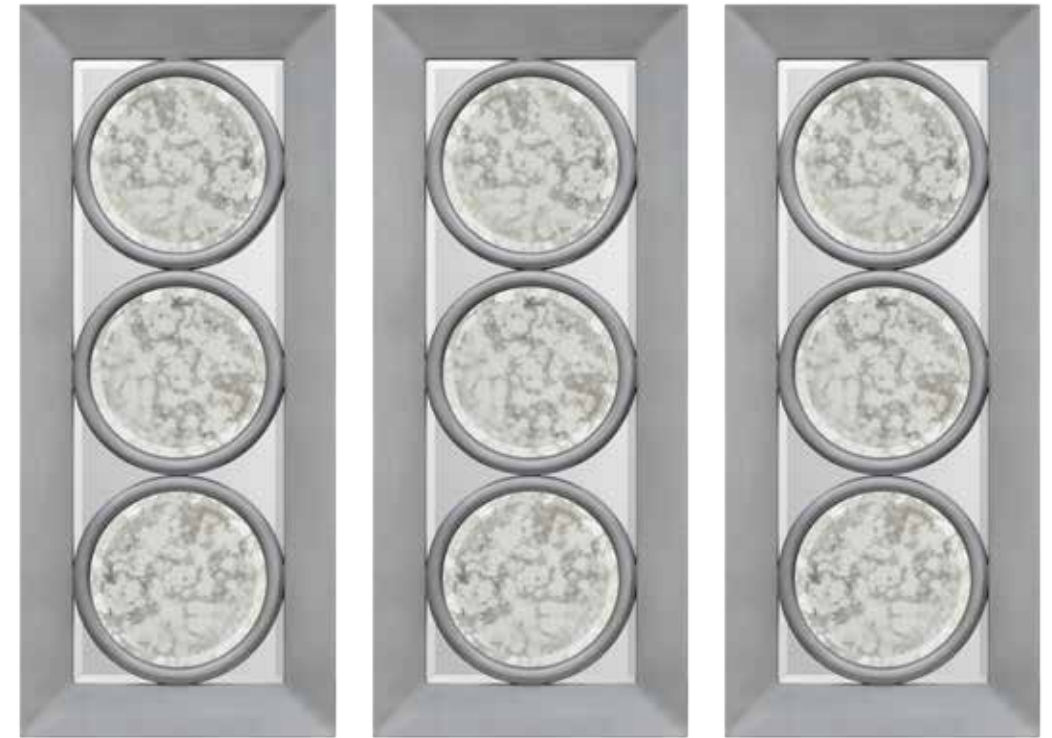

NIKO | 15080  
DESCRIPTION: DECORATIVE MIRROR SHOWN  
IN ANTIQUE MIRROR AND SILVER LEAF.  
SHOWN IN A SET OF 3 (CAN BE PURCHASED  
INDIVIDUALLY)

SAHARA | 15079  
DESCRIPTION: DECORATIVE MIRROR  
SHOWN IN BRONZE, ANTIQUE MIRROR  
AND SILVER LEAF.  
SHOWN IN A SET OF 2 (CAN BE  
PURCHASED INDIVIDUALLY)



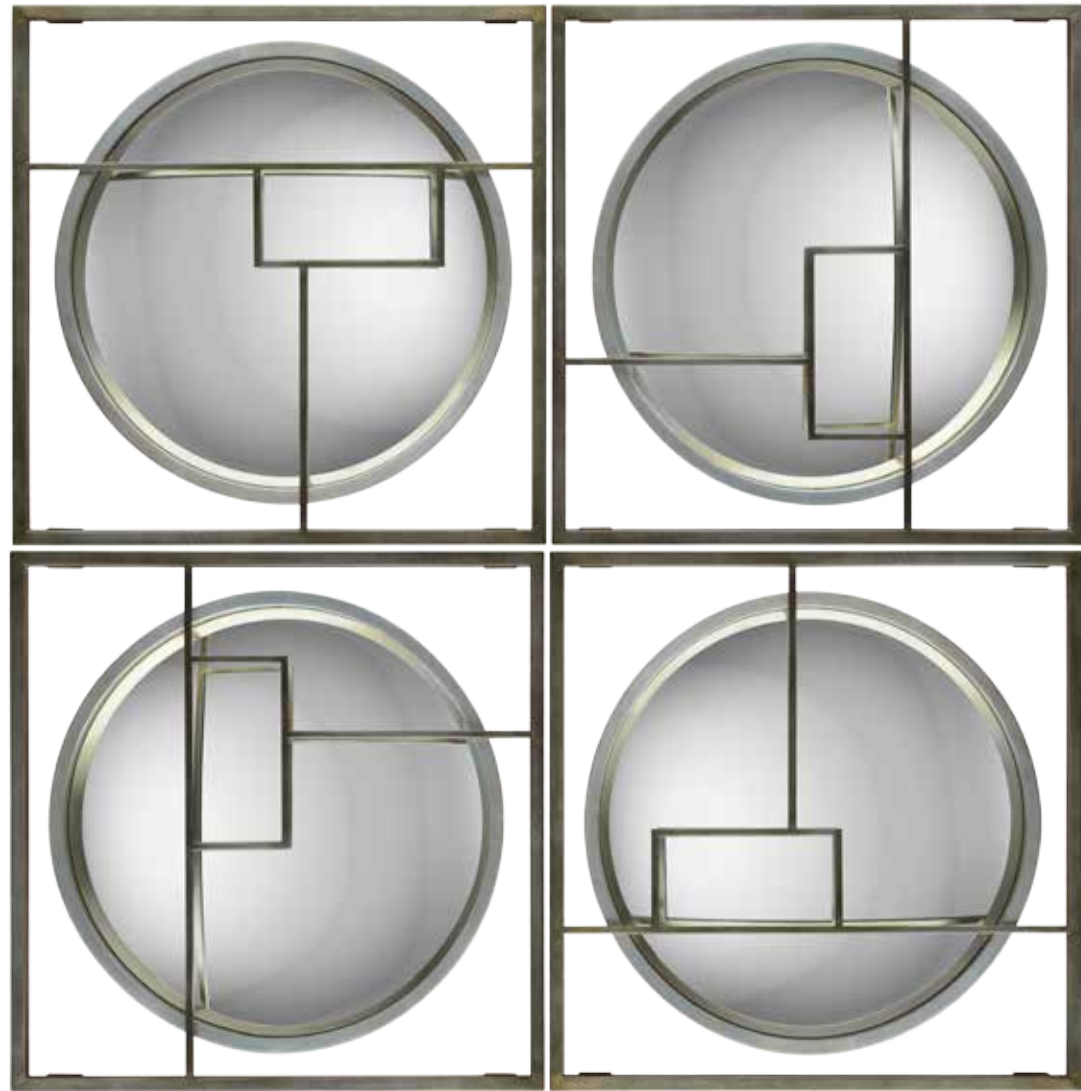

GEAR | 15550  
 DESCRIPTION: DECORATIVE  
 MIRROR WITH ABSTRACT METAL  
 OVERLAY. SHOWN IN SILVER LEAF



GRATE | 15175  
 DESCRIPTION: DECONSTRUCTED  
 FRAME WITH DIAMOND GRIP  
 TEXTURE SHOWN IN SILVER LEAF

TREAD | 15546  
 DESCRIPTION: RIPPLED DECORATIVE  
 MIRROR SHOWN IN SILVER LEAF

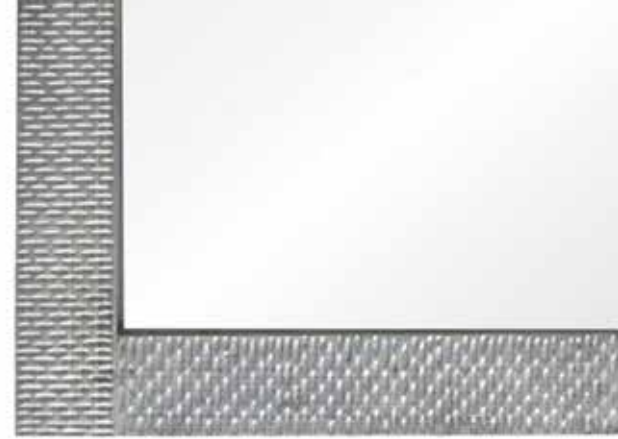



RAIN | 15656  
 DESCRIPTION: DECORATIVE MIRROR WITH WOOD, STONE, AND ROPE LIKE FRAME SHOWN WITH BLACK EDGES

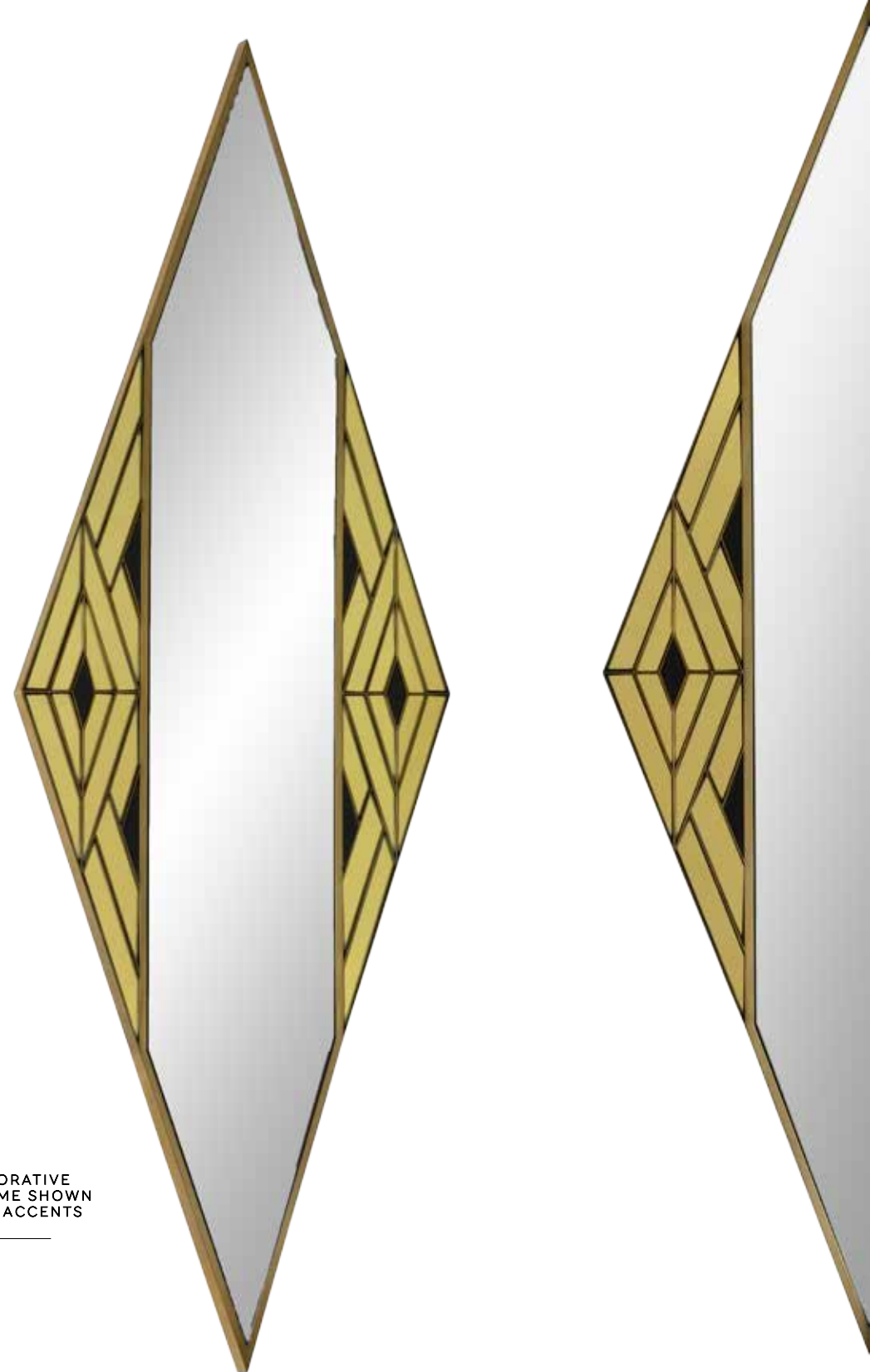

CRYSTAL | 15665  
 DESCRIPTION: DECORATIVE GOLD MIRROR FRAME SHOWN IN ANTIQUE BRASS ACCENTS



MOXY | 15012  
DESCRIPTION: SHADOWBOX  
FRAME SHOWN IN WALNUT WITH  
MIRROR INSET



NIKKI | 15565  
DESCRIPTION: FLOATER  
FRAME SHOWN IN  
WALNUT FINISH



DYLAN | 15013  
DESCRIPTION: SHADOWBOX FRAME  
SHOWN IN ESPRESSO WITH MIRROR  
INSET AND STONE SHELF





FORREST | 15654  
DESCRIPTION: WOOD  
FRAME WITH A POLISHED  
STAINLESS STEEL TRIM  
DETAIL SHOWN IN WALNUT

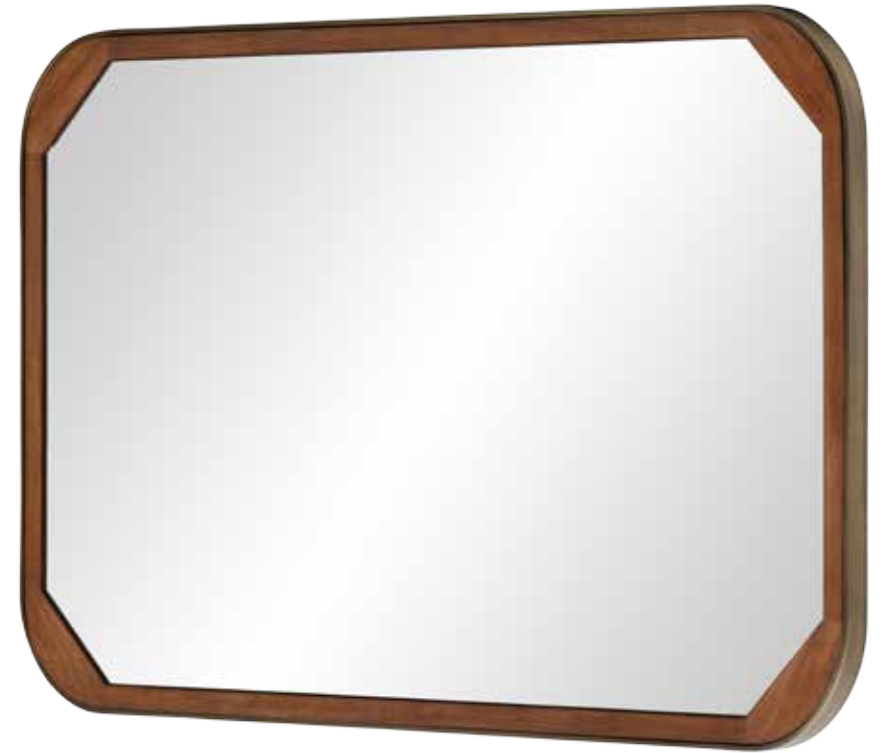

TIMBER | 15664  
DESCRIPTION: MINIMALIST  
METAL FRAME WITH WOOD  
TONE DETAIL SHOWN IN  
ANTIQUÉ BRASS

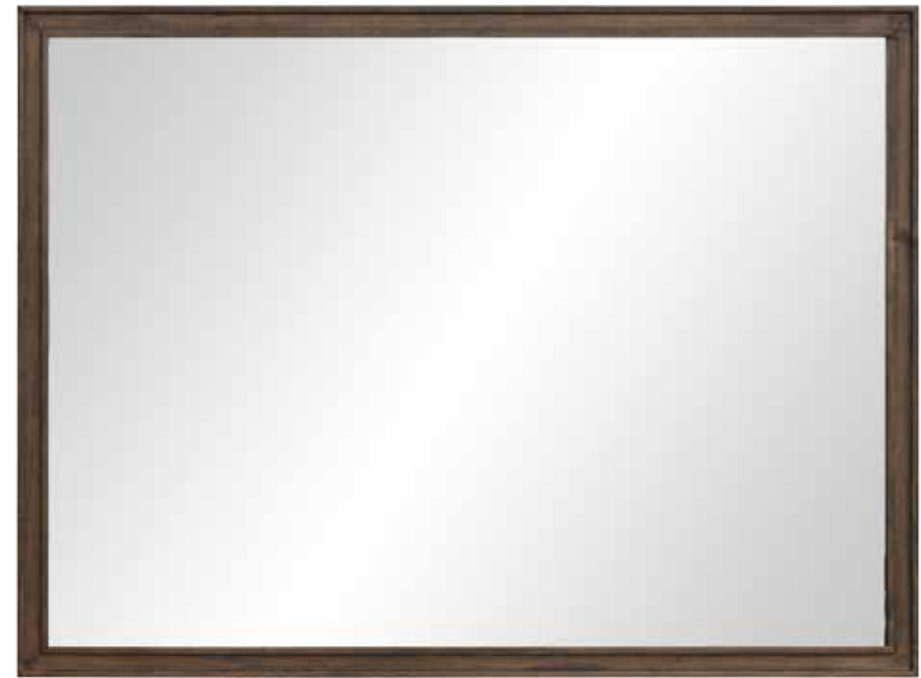

OAK | 15668  
DESCRIPTION: WOOD  
FRAME SHOWN IN WALNUT



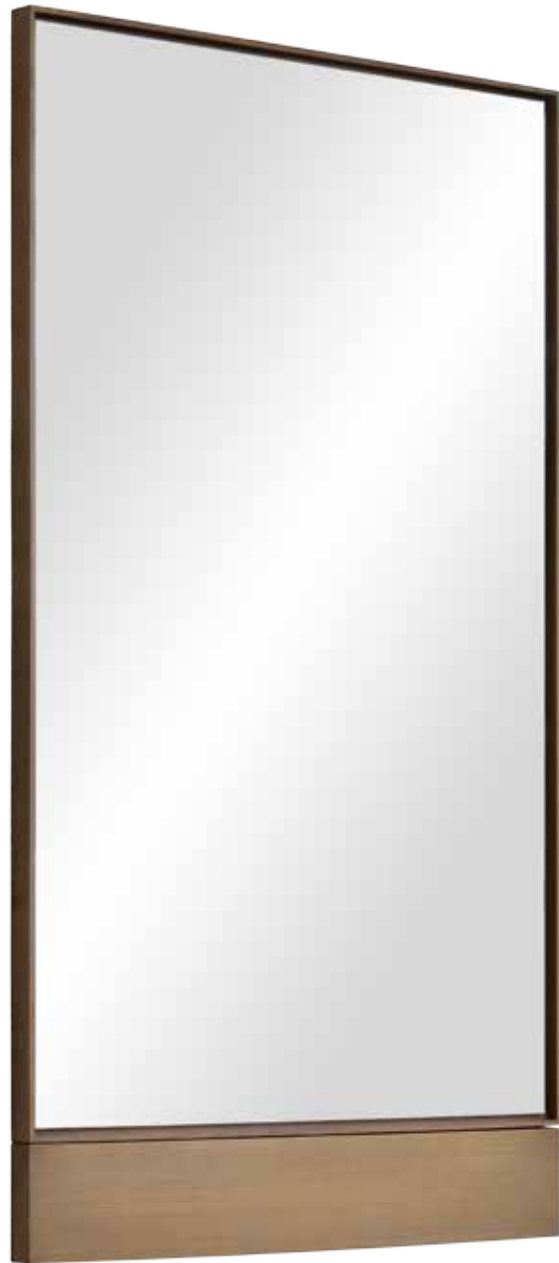

ORCHARD | 15669  
DESCRIPTION: WOOD  
FLOATER FRAME SHOWN IN  
NATURAL OAK

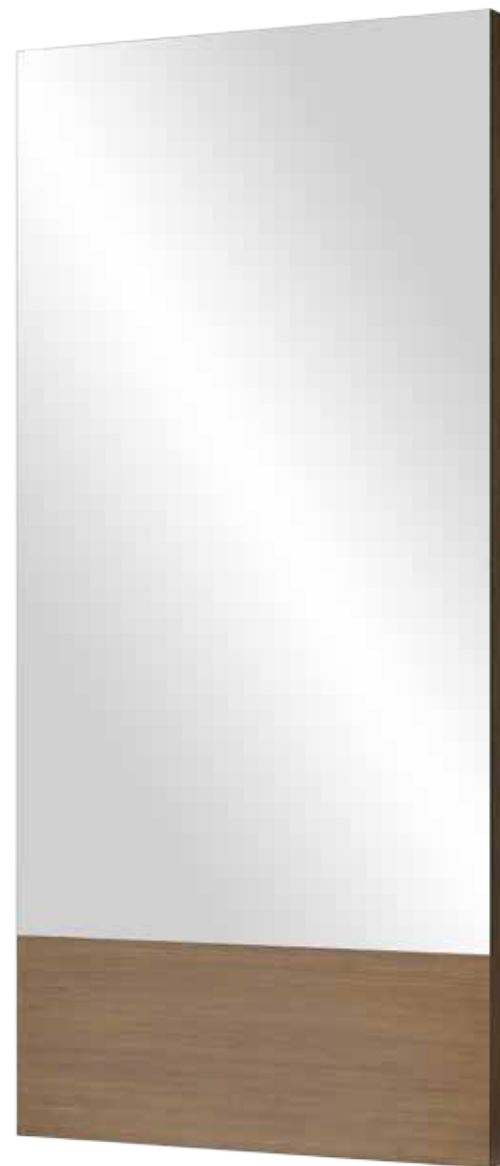

YOSEMITE | 15670  
DESCRIPTION: FRAMELESS  
MIRROR SHOWN IN NATURAL  
OAK EDGES



SEQUOIA | 15666  
DESCRIPTION: WOOD  
FRAME SHOWN IN CEDAR





VIDA | 15541  
DESCRIPTION: DECORATIVE  
MIRROR SHOWN IN MOTTLED  
BRONZE AND CLEAR MIRROR  
FRAME



CUBA | 15069  
DESCRIPTION: MITERED MIRROR  
-FRAMED-MIRROR SHOWN IN  
MOTTLED BRONZE FINISH

GLORIA | 15510  
DESCRIPTION: MITERED  
MIRROR-FRAMED-MIRROR  
SHOWN IN MOTTLED BRONZE  
FINISH



**WHITE PEARL | 15188**  
DESCRIPTION: DECORATIVE FRAME WITH  
ORNATE CROWN SHOWN IN HIGH GLOSS WHITE



**BLACK PEARL | 15190**  
DESCRIPTION: DECORATIVE FRAME WITH  
ORNATE CROWN SHOWN IN HIGH GLOSS EBONY



**CORNELIUS | 15549**  
DESCRIPTION: BEVELED MIRROR  
WITH DECORATIVE CAPS SHOWN  
IN HIGH GLOSS WHITE



**LOUIS | 15676**  
DESCRIPTION: DECORATIVE ORNATE  
FRAME SHOWN IN SILVER LEAF



GENE | 15542  
DESCRIPTION: DECORATIVE FRAME WITH  
DIAMOND V-GROOVE PATTERN SHOWN  
IN CAPIZ SHELL AND MATTE BLACK



ASHER | 15561  
DESCRIPTION: ORNATE  
DECORATIVE FRAME SHOWN IN  
CHAMPAGNE SILVER LEAF



KYRO | 15652  
DESCRIPTION: DECORATIVE  
FRAME SHOWN IN CHAMPAGNE





ELLEN | 15555  
DESCRIPTION: DECORATIVE  
MIRROR SHOWN IN HIGH  
GLOSS WHITE

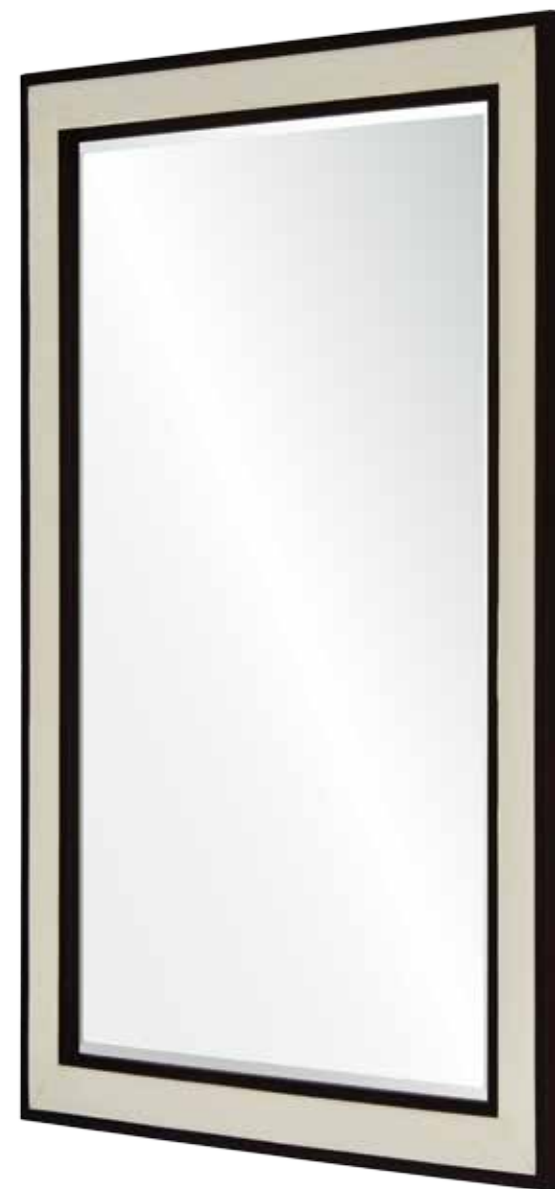

PUMA | 15570  
DESCRIPTION: DECORATIVE  
FRAME SHOWN IN MACASSAR  
WITH DOVE WHITE INSET



### TOOL BOX

OUR WALL DECOR CAN BE DESIGNED TO FIT ANY INTERIOR ARCHITECTURE WITHOUT A HITCH. WE HAVE 25+ YEARS OF EXPERIENCE AND ARE HERE TO HELP FIND A SOLUTION FOR YOUR GUESTROOM.

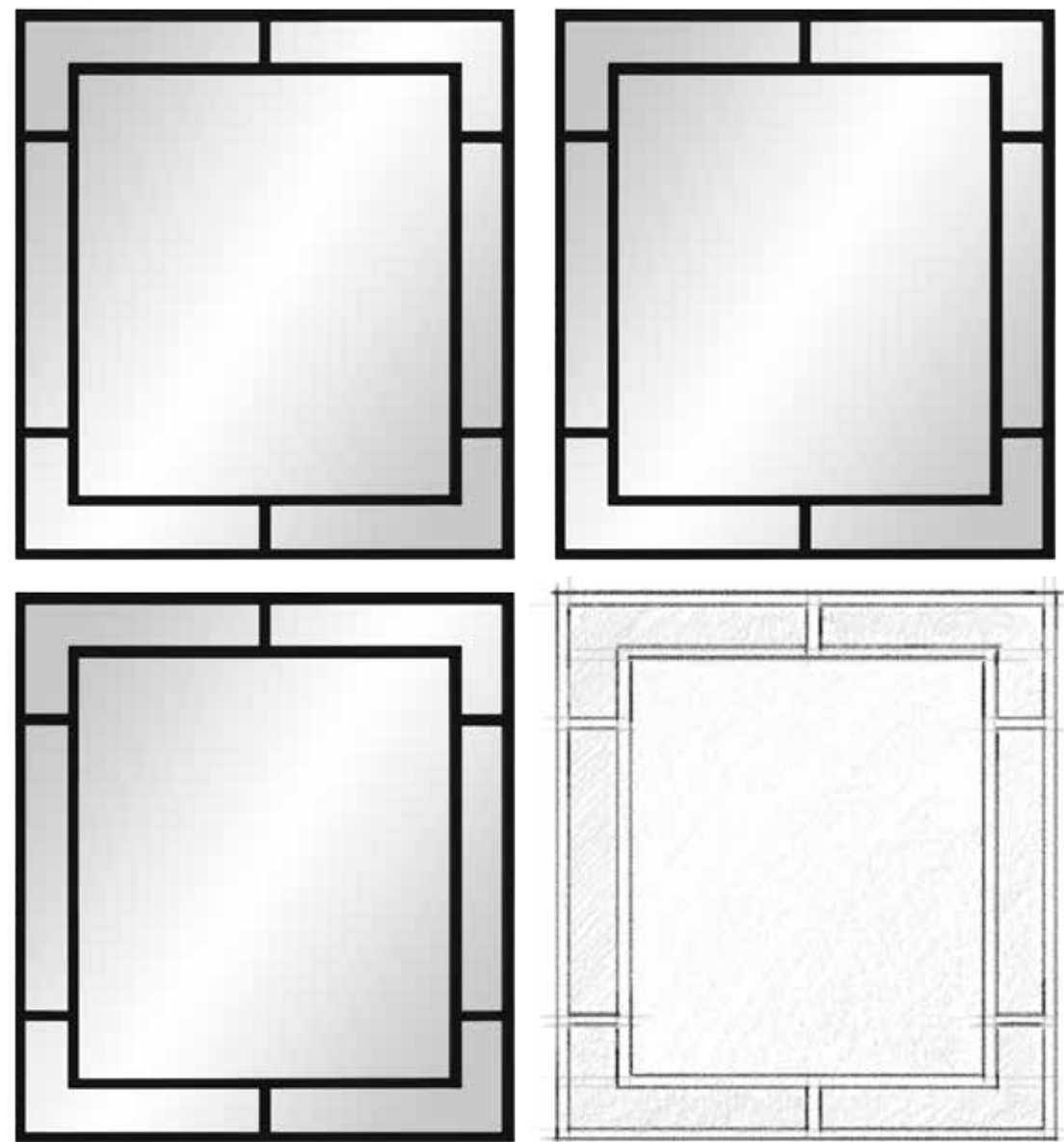

LUCA | 15557  
DESCRIPTION: DECORATIVE METAL FRAME WITH METAL OVERLAY SHOWN IN EBONY



CASTRO | 15648  
DESCRIPTION: DECORATIVE FRAME SHOWN IN FAUX HORN WITH CUTOUT TO ACCOMODATE EXISTING FLOOR MOULDING



LEVI | 15543  
DESCRIPTION: DECORATIVE MIRROR SHOWN IN PAINTED GUNMETAL WITH CUTOUT TO ACCOMODATE EXISTING FLOOR MOULDING



# SUSPENDED M I R R O R S

All of our mirrors can be built to appear suspended on a wall and produced with the hotel environment in mind. Each mirror is secured to the wall with a cleat while it appears to be suspended by a strap of your choice. The strap can be made of leather, metal, rope or any material and finish you wish! Select your mirror, a strap and a knob and we will build your mirror to spec. Add backlighting for additional interest and light (see page 206 for some of our backlit suspended mirrors).

RYAN | 15603  
DESCRIPTION: MINIMALIST  
SUSPENDED METAL FRAME SHOWN  
IN POLISHED BLACK NICKEL



WYATT | 15075  
DESCRIPTION: SUSPENDED  
MINIMALIST METAL FRAME SHOWN  
IN BLACK FINISH WITH BLACK VINYL  
STRAP AND BRASS HARDWARE



KNOTS | 15077  
DESCRIPTION:  
SUSPENDED MIRROR  
SHOWN IN DEEP SEA BLUE  
AND FISHERMAN'S ROPE



JAX | 15536  
DESCRIPTION: SUSPENDED MIRROR  
SHOWN IN SILVER LEAF FRAME  
WITH CHARCOAL VINYL STRAP AND  
POLISHED CHROME HARDWARE



SAGE | 15076  
DESCRIPTION: SUSPENDED MIRROR  
SHOWN IN PAINTED GREEN,  
MATCHING SHAGREEN VINYL STRAP  
AND BRASS HARDWARE

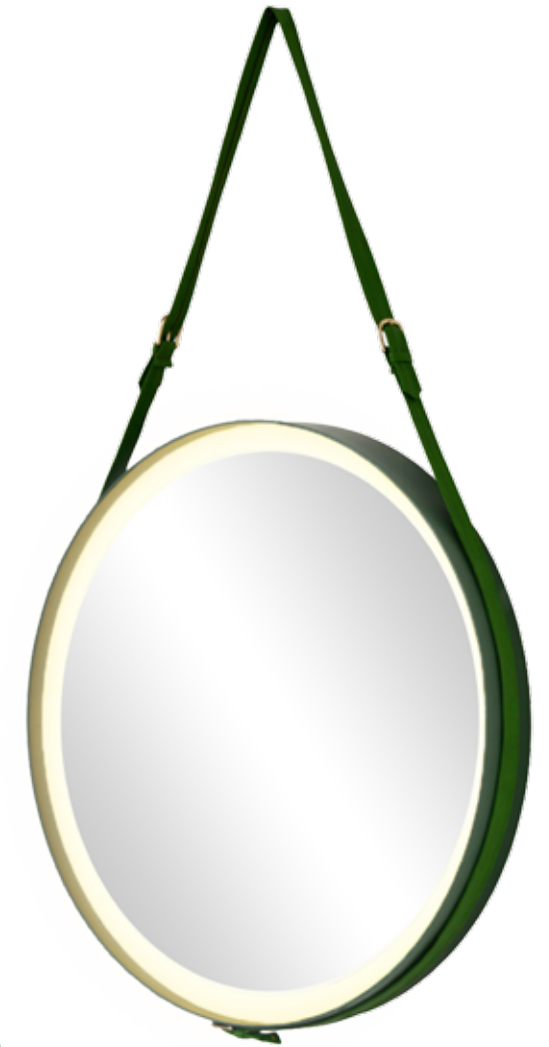

BEAM | MS15137  
DESCRIPTION: SUSPENDED  
LIGHTED MIRROR SHOWN IN  
GREEN METAL FRAME AND  
MATCHING SHAGREEN VINYL  
STRAP AND BRASS HARDWARE





LESTER | 15677  
 DESCRIPTION: SUSPENDED MIRROR  
 SHOWN IN BRUSHED BRASS FRAME  
 WITH BLACK VINYL STRAP AND  
 BRUSHED BRASS HARDWARE



MADISON | 15679  
 DESCRIPTION: SUPENDED  
 MIRROR SHOWN IN CAMEL VINYL  
 LEATHER WITH BLACK HARDWARE





COOPER | 10359  
DESCRIPTION:  
DECORATIVE FRAME  
SHOWN IN SILVER LEAF



ROXY | 10362  
DESCRIPTION:  
DECORATIVE FRAME  
SHOWN IN SILVER LEAF

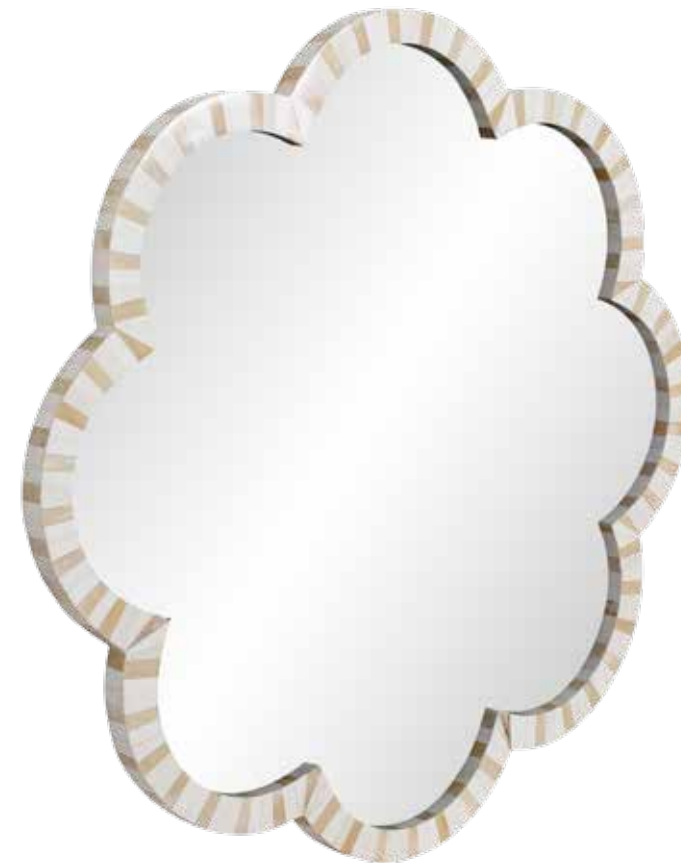

PENELOPE | 15519  
DESCRIPTION: DECORATIVE  
FRAME. SHOWN IN A  
STRIATED IVORY FINISH



AIDEN | 15016  
DESCRIPTION: DECORATIVE  
FRAME SHOWN IN STRIATED  
CHAMPAGNE FINISH



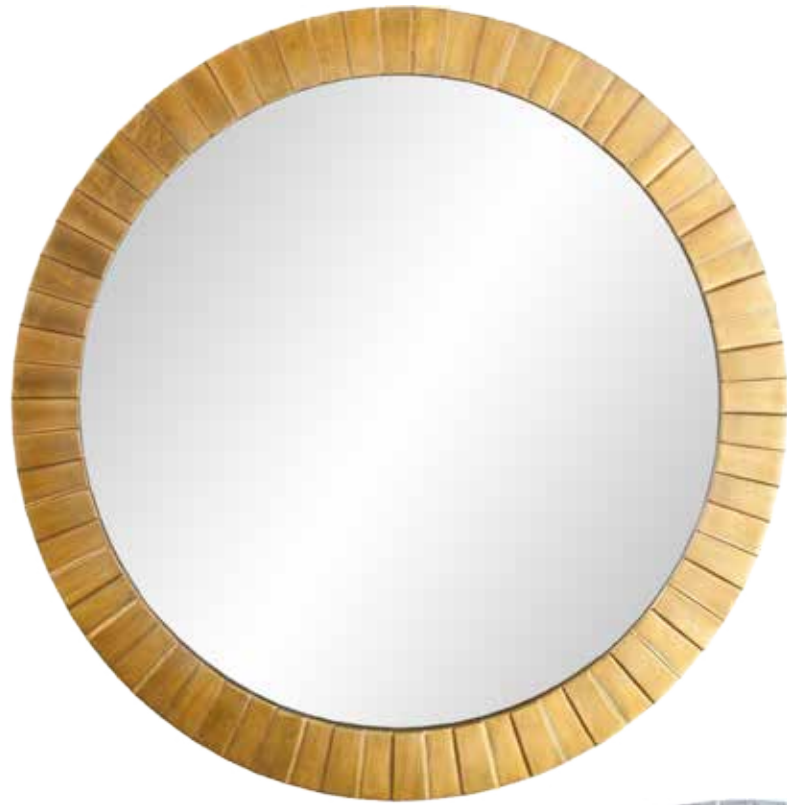

ANDERSON | 10156 GOLD  
DESCRIPTION: DECORATIVE  
FRAME SHOWN IN GOLD LEAF



ANDERSON | 10156 SILVER  
DESCRIPTION:  
DECORATIVE MIRROR  
SHOWN IN SILVER LEAF



GRACE | 10302 GOLD  
DESCRIPTION: CHAIN INSPIRED  
FRAME SHOWN IN GOLD LEAF



GRACE | 10302 SILVER  
DESCRIPTION: CHAIN INSPIRED  
FRAME SHOWN IN SILVER LEAF



STEPHANIE | 15186  
DESCRIPTION: MINIMALIST FRAME  
WITH CONVEX MIRROR DETAIL



TOWNES | 15579  
DESCRIPTION: MIRROR FRAMED WITH  
ANTIQUED AND CLEAR MIRROR SHOWN  
IN DISTRESSED GOLD LEAF ACCENTS

LARRY | 15661  
DESCRIPTION: MIRROR FRAMED MIRROR  
SHOWN IN SILVER LEAF ACCENTS





DAHLIA | 15105  
DESCRIPTION: SCALLOPED FRAME  
MIRROR SHOWN IN EGGPLANT



JASMINE | 15103  
DESCRIPTION: SCALLOPED  
FRAME SHOWN IN SILVER LEAF

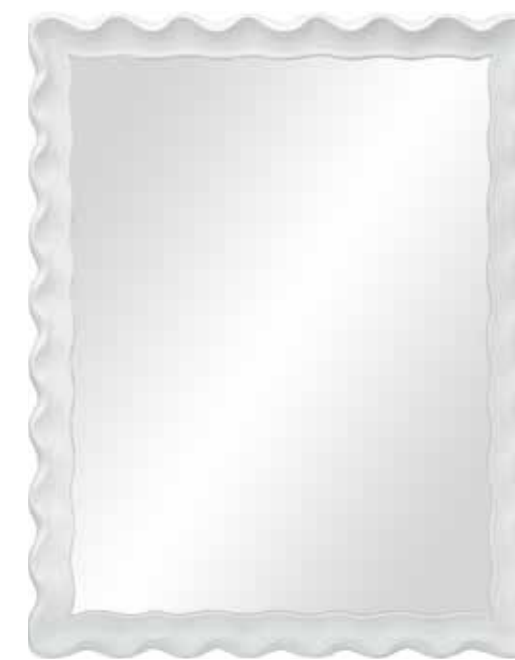

POPPY | 15101  
DESCRIPTION: SCALLOPED FRAME  
SHOWN IN WHITE LACQUER



BUTTERCUP | 15104  
DESCRIPTION: SCALLOPED  
FRAME SHOWN IN GOLD LEAF



TULIP | 15102  
DESCRIPTION: SCALLOPED FRAME  
SHOWN IN BLACK LACQUER



JULIAN | 15114  
DESCRIPTION: INDUSTRIAL  
INSPIRED FRAME SHOWN IN  
MATTE EBONY FINISH



LORENZO | 15502  
DESCRIPTION: INDUSTRIAL  
INSPIRED FRAME SHOWN IN  
MATTE CHOCOLATE FINISH

MARCELL | 15115  
DESCRIPTION: INDUSTRIAL INSPIRED  
FRAME SHOWN IN MATTE SLATE FINISH





# LEATHER WRAPPED

Wrap or suspend your frame with or those that are available to us, our leather or vinyl. Whether you select artistry is top notch. Add a zipper, leather or vinyl from a specific supplier, stitch work or nailhead for added detail.



STITCH | 15301  
DESCRIPTION: LEATHER WRAPPED FRAME WITH EMBOSING SHOWN IN COFFEE

TAILOR | 15300  
DESCRIPTION: LEATHER WRAPPED FRAME WITH EMBOSING SHOWN IN EBONY



WILLOW | 15131  
DESCRIPTION: LEATHER WRAPPED  
FRAME WITH CORNER DETAIL  
SHOWN IN BRONZE SHAGREEN



SAM | 15647  
DESCRIPTION: MIRROR PANELED  
FRAME SHOWN IN WRAPPED  
SHAGREEN VINYL



LEO | 15132  
DESCRIPTION: VINYL WRAPPED  
FRAME WITH CORNER DETAIL  
SHOWN IN CAMEL WITH GOLD ZIPPER



JUNE | 15651  
DESCRIPTION: VINYL  
WRAPPED FRAME SHOWN IN  
BLACK SHAGREEN WITH RED  
UNDERTONE

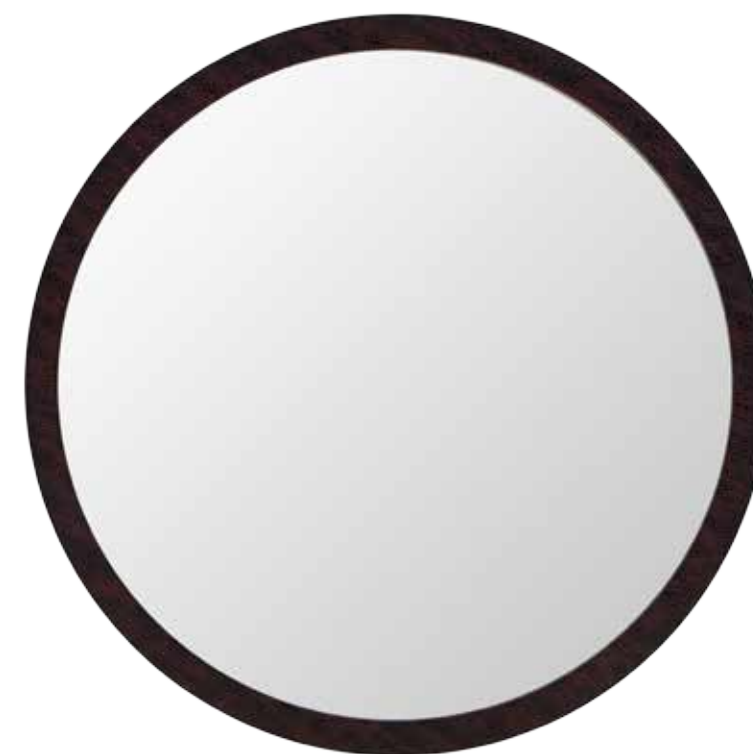





BAILEY | 15128  
DESCRIPTION: LEATHER WRAPPED  
FRAME WITH CORNER DETAIL SHOWN  
IN BRONZE SHAGREEN



DESTINY | 15127  
DESCRIPTION: LEATHER WRAPPED  
FRAME WITH CORNER DETAIL SHOWN IN  
CHARCOAL SHAGREEN



WADE | 15129  
DESCRIPTION: VINYL  
WRAPPED FRAME WITH  
CORNER DETAIL SHOWN IN  
CAMEL WITH GOLD ZIPPER



BLAKE | 15123  
DESCRIPTION: ABSTRACT  
DECORATIVE MIRROR  
SHOWN IN FAUX WALNUT



DINA | 15113  
DESCRIPTION: DECORATIVE MIRROR  
SHOWN IN WALNUT STAINED BIRCH  
WOOD

INDY | 15116  
DESCRIPTION: DECORATIVE  
MIRROR SHOWN IN MEDIUM OAK  
STAIN FRAME WITH WALNUT INSET



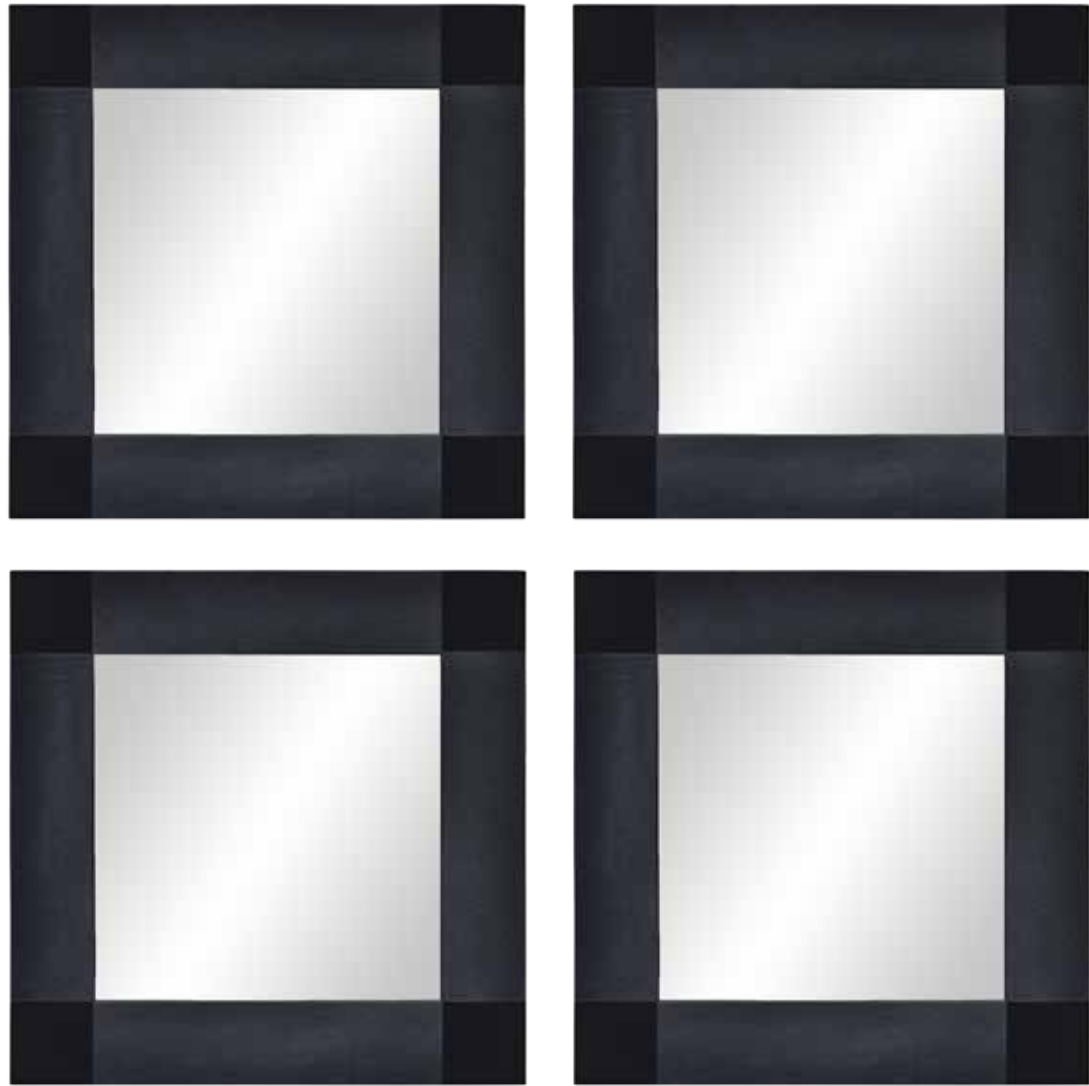

MAKO | 15074  
 DECORATIVE FRAME SHOWN IN  
 BLACK SHAGREEN AND BLACK VINYL  
 SHOWN IN A SET OF 4 (CAN BE  
 PURCHASED INDIVIDUALLY)



KIKO | 15518  
 DESCRIPTION: DECORATIVE  
 FRAME SHOWN IN ESPRESSO



TIGER | 10369  
 DESCRIPTION: DECORATIVE MIRROR  
 SHOWN IN DARK ZEBRAWOOD



ROOSEVELT | 15672

M I R R O R  
F R A M E D  
M I R R O R S

Utilize all of our antique and colored for your space. Add custom printed mirror (see page 102) in different shapes patterns, etching or convex shapes to and patterns to create a unique mirror any mirror to add dimension.



FRANKIE | 15569  
DESCRIPTION: MINIMALIST  
FRAME SHOWN IN ANTIQUE  
MIRROR AND SILVER LEAF



PARIS | 15573  
DESCRIPTION: MINIMALIST FRAME  
SHOWN IN ANTIQUE MIRROR AND  
SILVER LEAF



REBEL | 15181  
DESCRIPTION: MIRROR-FRAMED-  
MIRROR SHOWN IN POLISHED  
CHROME FRAME DETAIL



NIX | 10354  
DESCRIPTION: MIRROR-FRAMED-MIRROR  
SHOWN IN WHITE LACQUER EDGES



DIVA | 15568  
DESCRIPTION: MITERED MIRROR-  
FRAMED-MIRROR WITH BEVEL



HYDE | 15110  
DESCRIPTION: MIRROR-FRAMED-  
MIRROR SHOWN IN CLEAR MIRROR



HARLOW | 15111  
DESCRIPTION: MIRROR-  
FRAMED-MIRROR SHOWN IN  
CLEAR MIRROR



NORTH | 15574  
DESCRIPTION: MINIMALIST METAL  
FRAMED MIRROR WITH ETCHED  
STAR DETAIL SHOWN IN EBONY





EDEN | 15598  
DESCRIPTION: VENETIAN MIRROR  
WITH CONVEX DETAILING



CHEYNNE | 15625  
DESCRIPTION: MIRROR-FRAMED-MIRROR  
WITH BEVELED CONVEX DETAIL

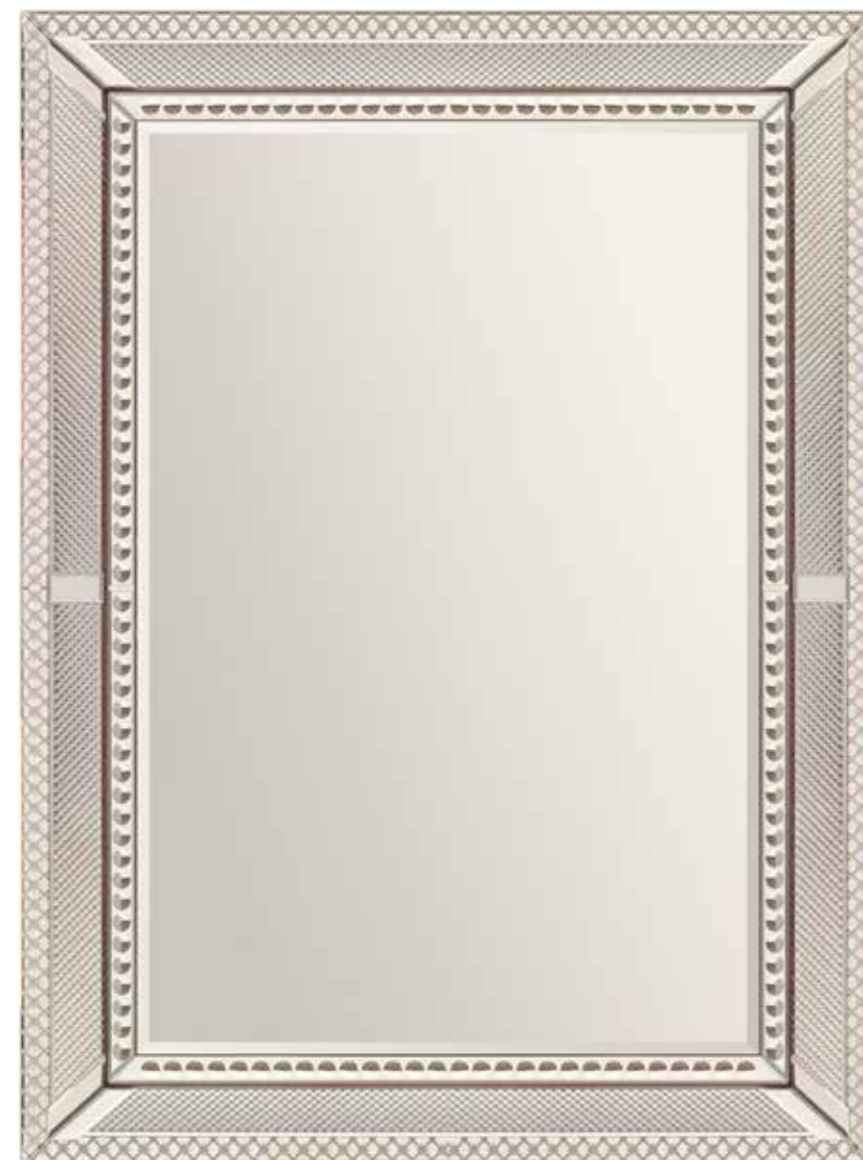

ROOSEVELT | 15672  
DESCRIPTION: MIRROR-FRAMED-MIRROR  
WITH BEVELED CONVEX AND ETCHING DETAIL

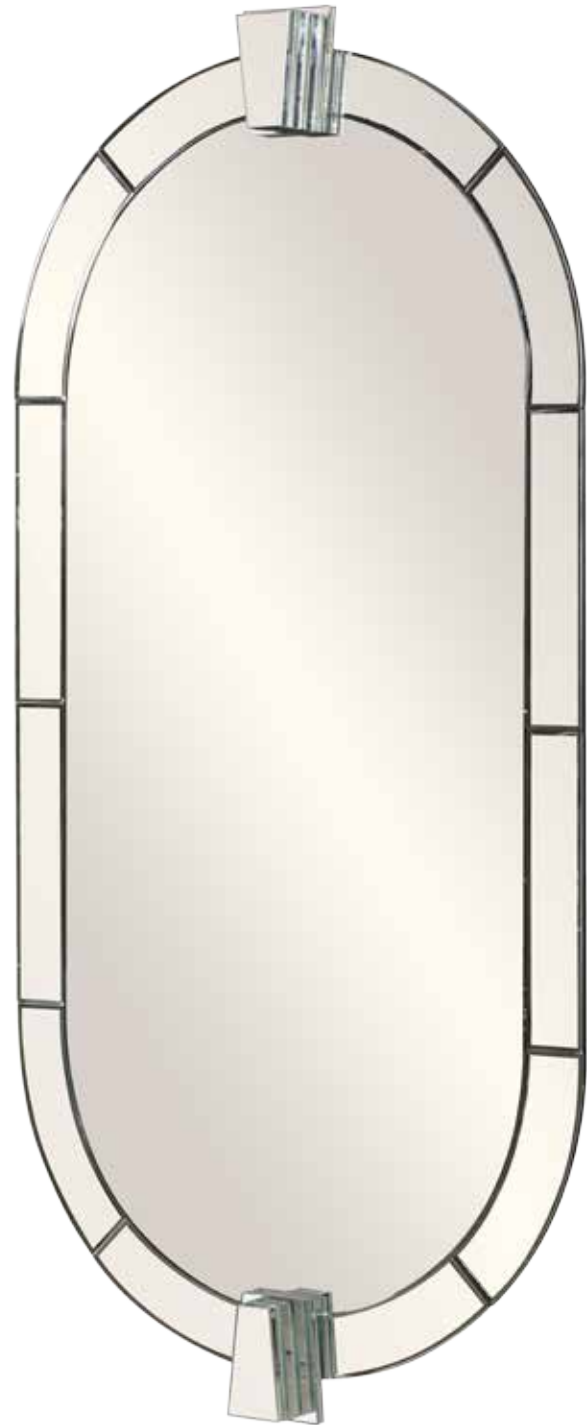

SIMON | 15021  
DESCRIPTION: MIRROR-FRAMED-  
MIRROR WITH MIRRORED DETAIL



GARFUNKEL | 15118  
DESCRIPTION: MIRROR-FRAMED-  
MIRROR WITH MIRRORED DETAIL



IVY | 15083  
DESCRIPTION: MIRROR-FRAMED-  
MIRROR WITH MIRRORED DETAIL





# OUR BACKLIT MIRRORS

Since 2007, Mirror Image has been a leading manufacturer of backlit mirrors. We use only the best, brand name components to ensure our clients are getting the best quality backlit mirror to last them longer than our 5 year warranty. Customize the frosted pattern, size and shape, light color and frame them in just about any material you can think of. Add a nightlight, defogger or acrylic diffusers to any of our backlit mirrors as well. Any of our decorative mirrors can be transformed into a backlit mirror.



Each of our backlit mirrors are manufactured for simple installation as well as easy access to the lighting components to the frame. Most of our backlit mirrors are constructed as such as the below illustration. The metal box is first hung by a cleat to the wall. The mirror is then hung in using metal clips that slide into the metal box easily.

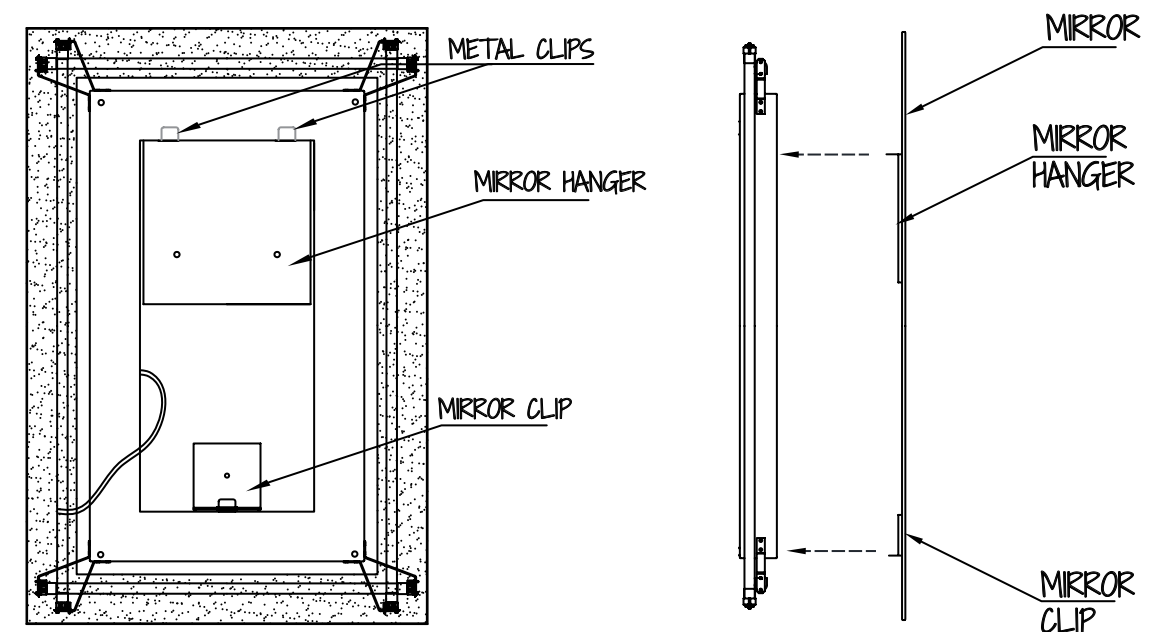



ENERGY | MS15009  
DESCRIPTION: BACKLIT MIRROR  
WITH 3 INCH FROSTING  
AT PERIMETER AND HALO  
LIGHTING SHOWN IN 3000K

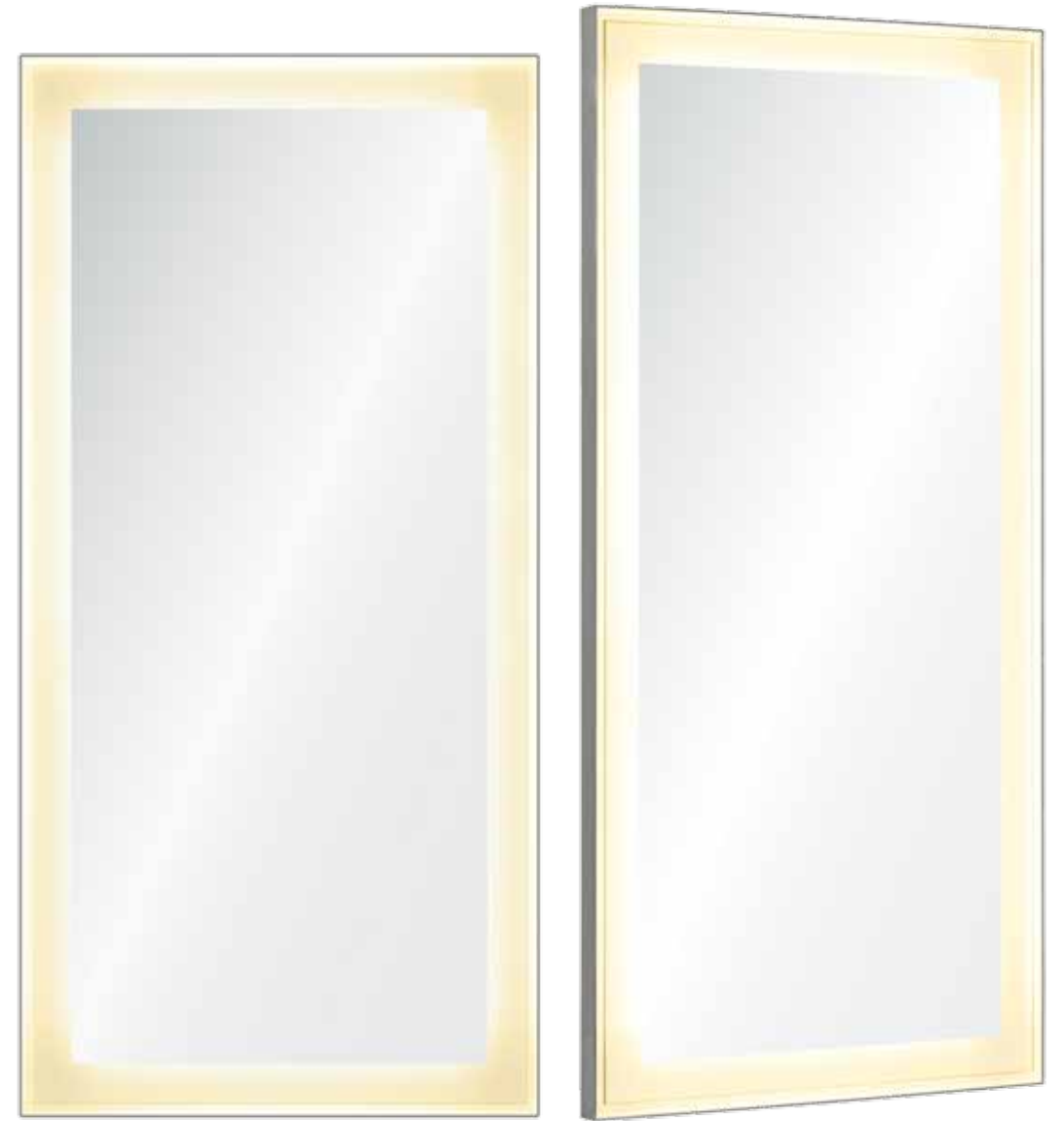

JOLT | MS15179  
DESCRIPTION: POLISHED CHROME  
MINIMALIST METAL FRAME WITH REVEAL  
BETWEEN FRAME AND 2 INCH FROSTED  
STRIP AT PERIMETER SHOWN IN HIGH  
GLOSS WHITE AND 2700K





VELOCITY | MS13034  
DESCRIPTION: FRAMED BACKLIT MIRROR WITH 3 INCH FROSTED STRIPS SHOWN IN POLISHED CHROME AND 3000K



ARCHER | MS15649  
DESCRIPTION: MINIMALIST METAL FRAME SHOWN IN MATTE BLACK (SHOWN IN 3000K)

CIRCUIT | MS13031  
DESCRIPTION: ROUND MIRROR WITH 3" FROSTED STRIP 1/4" FROM THE PERIMETER WITH HALO LIGHTING SHOWN IN 3000K





SOLAR | MS13032  
DESCRIPTION: 3" FROSTED STRIPS ON EITHER SIDE OF MIRROR SHOWN IN 3000K.



FLASH | MS15194  
DESCRIPTION: FRAMED BACKLIT MIRROR WITH 2 INCH FROSTED STRIPS AT EITHER SIDE SHOWN IN DARK ZEBRAWOOD, CAPIZ SHELL AND 3000K.

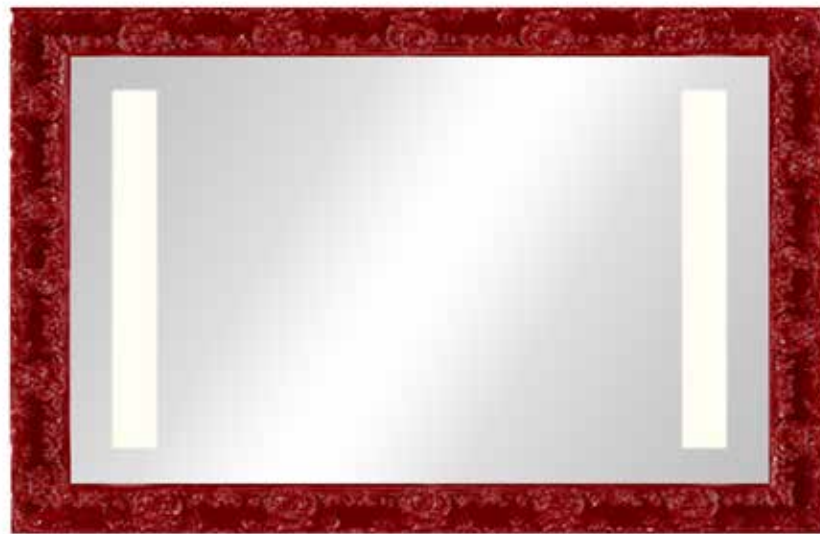

LIVE | MS13071  
 DESCRIPTION: FRAMED MIRROR WITH FROSTED STRIPS ON EITHER SIDE SHOWN IN HIGH GLOSSS RED AND 2700K

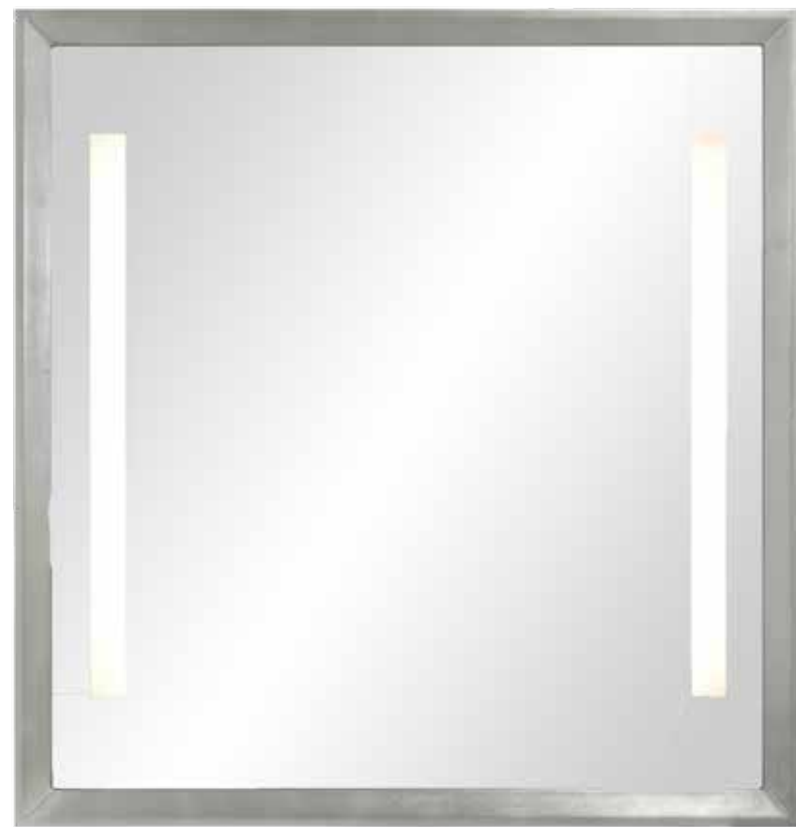

SPARK | MS15178  
 DESCRIPTION: FRAMED MIRROR WITH FROSTED STRIPS ON EITHER SIDE SHOWN IN SILVER LEAF AND 2700K



CHARGE | MS13043  
 DESCRIPTION: MIRROR WITH FROSTED PATTERN AT EITHER SIDE SHOWN IN 3000K

GRID | MS13033  
 DESCRIPTION: VENETIAN FRAMED MIRROR WITH 1 INCH FROSTED STRIP INSET IN FRAME SHOWN IN 3000K



**TOOL BOX**

ADD A TABLE OR SHELF TO ANY OF OUR BACKLIT MIRRORS TOO! SEND US YOUR VISION, AND THE MIRROR IMAGE TEAM WILL MAKE IT HAPPEN!



**THERMO | DS80008**  
DESCRIPTION: BACKLIT MIRROR WITH 3" FROSTED STRIPS ALONG THE PERIMETER WITH DESK SHOWN IN SILVER LEAF, TEMPERED GLASS TOP AND 2700K



**SHOCK | DS80009**  
DESCRIPTION: INSPIRED BY COLUM McCARTANS DESK LAMP DESIGN. ETCHED TABLE LAMP WITH DIMMER CONTROL AND DESK SHOWN IN SILVER LEAF, TEMPERED GLASS, POLISHED CHROME AND 2700K



SHORT | MS13040  
 DESCRIPTION: MIRROR  
 WITH HALO LIGHTING  
 SHOWN IN 3000K



FUEL | MS15538  
 DESCRIPTION: CUSTOM  
 ETCHED PATTERN WITH  
 HALO LIGHTING



IMPULSE | MS15558  
 DESCRIPTION: FROSTED STRIPS ON EITHER  
 SIDE OF THE MIRROR. THE AMENITY SHELF  
 AT THE BOTTOM OF THE MIRROR READS  
 "YOU LOOK GOOD TODAY!". SHOWN IN  
 POLISHED CHROME AND 2700K



PARTICLE | MS13037  
DESCRIPTION: POLISHED CHROME  
FRAME WITH LASER CUT PATTERN  
AND BACKLIGHTING SHOWN IN 3000K



BOLT | MS13030  
DESCRIPTION: ROUND MIRROR  
WITH 3 INCH FROSTED SECTION  
2 INCHES FROM MIRROR  
PERIMETER SHOWN IN 3000K



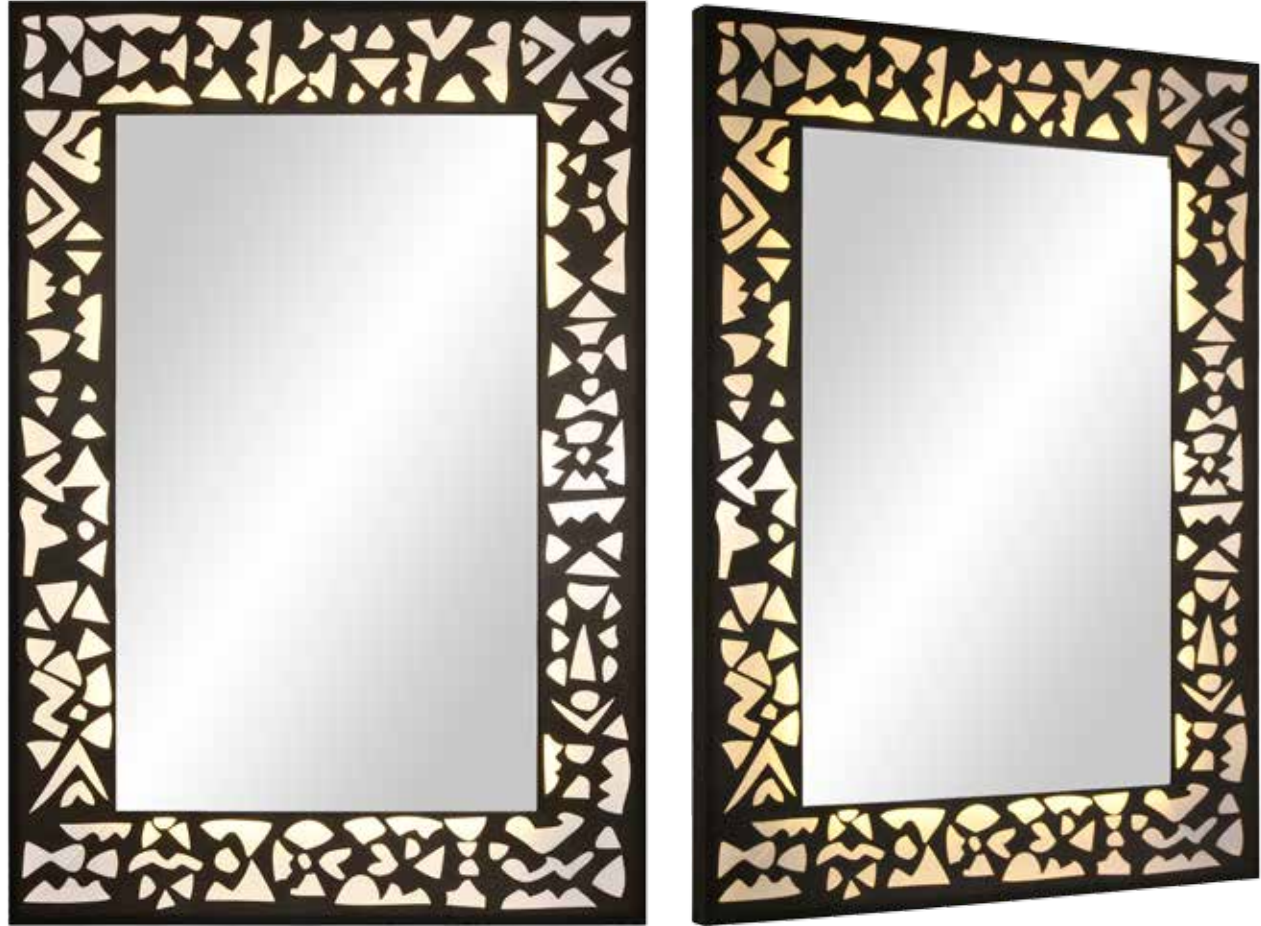

CURRENT | MS15537  
 DESCRIPTION: METAL FRAME  
 WITH ABSTRACT DIECUT AND  
 LIGHTING SHOWN IN OIL RUBBED  
 BRONZE AND 2700K



RADIANT | MS13041  
 DESCRIPTION: ROUND  
 MIRROR WITH HALO  
 LIGHTING AND TEMPERED  
 AMENITY SHELF SHOWN  
 IN POLISHED CHROME  
 STANDOFFS



BEAM | MS15137  
DESCRIPTION: SUSPENDED  
LIGHTED MIRROR SHOWN IN  
GREEN METAL FRAME AND  
MATCHING SHAGREEN VINYL  
STRAP AND BRASS HARDWARE

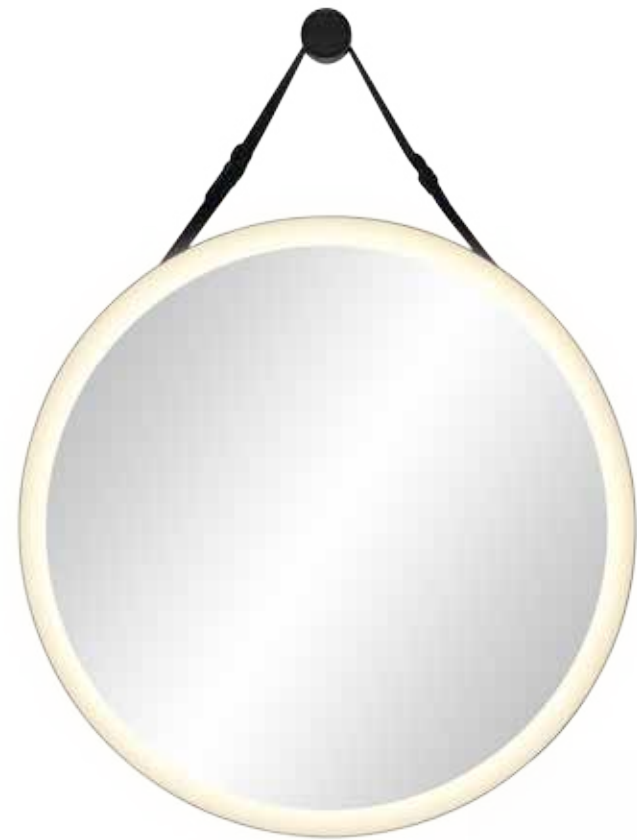

FLARE | MS15602  
DESCRIPTION: SUSPENDED BACKLIT  
MIRROR SHOWN IN BLACK METAL  
FRAME AND BLACK LEATHER STRAP  
SHOWN IN 3000K

ATOM | MS15614  
DESCRIPTION: SUSPENDED BACKLIT  
MIRROR SHOWN IN COGNAC METAL  
FRAME, COGNAC LEATHER STRAP  
AND 3000K

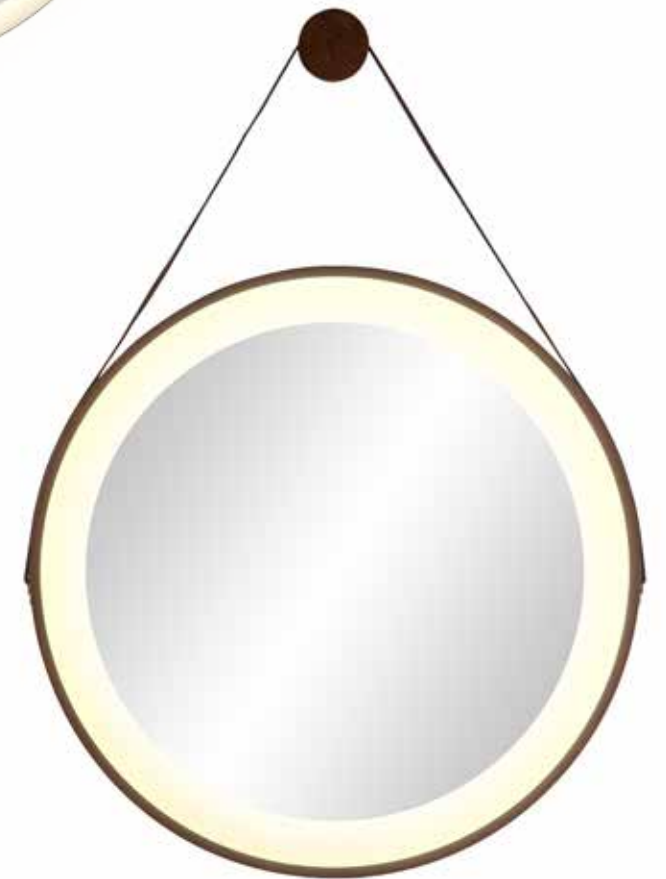



3000K

2700K

# BACKLIT MIRRORS

Each of our backlit mirrors are manufactured for simple installation as well as easy access to the lighting components. In addition to lighting, there are additional accessories that may be added; such as a digital clock, bluetooth and

other useful components to enhance your guests experience. While our bulbs come in a multitude of temperatures, our 2700 kelvin and 3000 kelvin are our most popular. Their differences are shown in our MS13043, above.



#### LED STRIP

A FLEXIBLE CIRCUIT BOARD POPULATED BY SURFACE MOUNTED LIGHT EMITTING DIODES. RECENT DEVELOPMENTS IN INCREASED LUMINOUS EFFICACY AND LONGER LIFESPANS HAVE ALLOWED LED STRIP LIGHTS TO BE USED IN APPLICATIONS SUCH AS HIGH BRIGHTNESS TASK LIGHTING, FLOURECENT AND HALOGEN LIGHTING FIXTURE REPLACEMENTS, INDIRECT LIGHTING APPLICATIONS. THE LOWER ENERGY COST TYPICALLY OFFSETS THE HIGHER INITIAL COST



#### LED T5 BULB

AN LED LAMP IS A LIGHT EMITTING DIODE (LED) PRODUCT WHICH IS ASSEMBLED INTO A LAMP FOR USE IN LIGHTING FIXTURES. LED LAMPS HAVE A LIFESPAN AND ELECTRICAL EFFICIENCY WHICH ARE SEVERAL TIMES LONGER THAN MOST FLOURESCENT LAMPS. THESE ENERGY SAVING LED LAMPS ARE QUICK, EASY AND SAFE TO INSTALL. MINIMIZING MAINTENANCE TIME.



#### HIGH OUTPUT T5 BULB

FLOURESCENT LAMP FIXTURES ARE A LOW COST SOLUTION WHILE EMITTING THE GREATEST AMOUNT OF LIGHT FOR YOUR MIRROR UNIT. SINCE THE INTRODUCTION AS A COMMERCIAL PRODUCT IN 1939 MANY DIFFERENT TYPES OF FLOURESCENT LAMPS HAVE BEEN INTRODUCED.

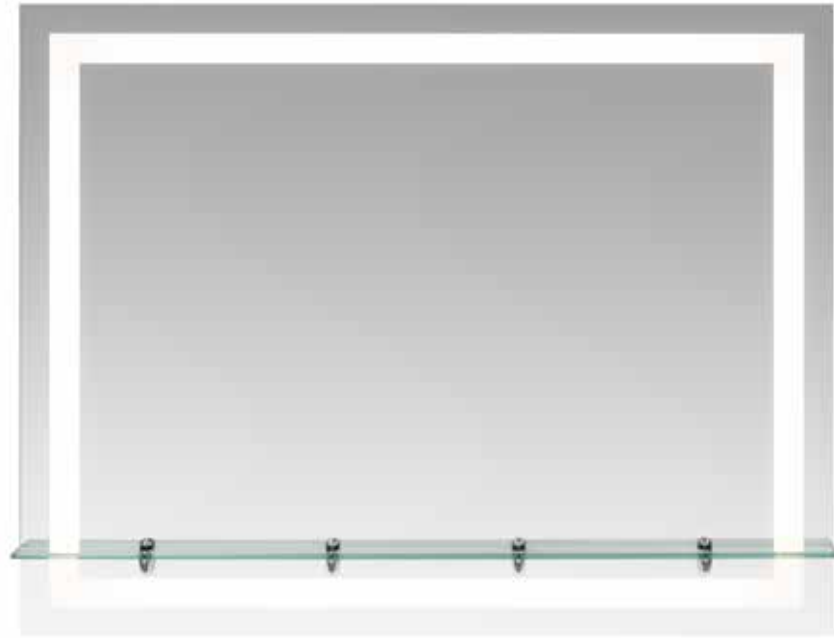

WATTS | MS15645  
 DESCRIPTION: 2 INCH STRIP INSET  
 2 INCHES FROM THE PERIMETER, A  
 TEMPERED GLASS AMENITY SHELF  
 WITH STANDOFFS SHOWN IN POLISHED  
 CHROME AND 3000K



VOLT | MS15620  
 DESCRIPTION: 2 INCH STRIP INSET  
 2 INCHES FROM THE PERIMETER,  
 EXCLUDING THE BOTTOM OF THE  
 MIRROR SHOWN IN 2700K



FUSE | MS13042  
 DESCRIPTION: 2 INCH FROSTED  
 STRIP ALONG THE PERIMETER  
 OF THE MIRROR WITH HALO  
 LIGHTING SHOWN IN 3000K

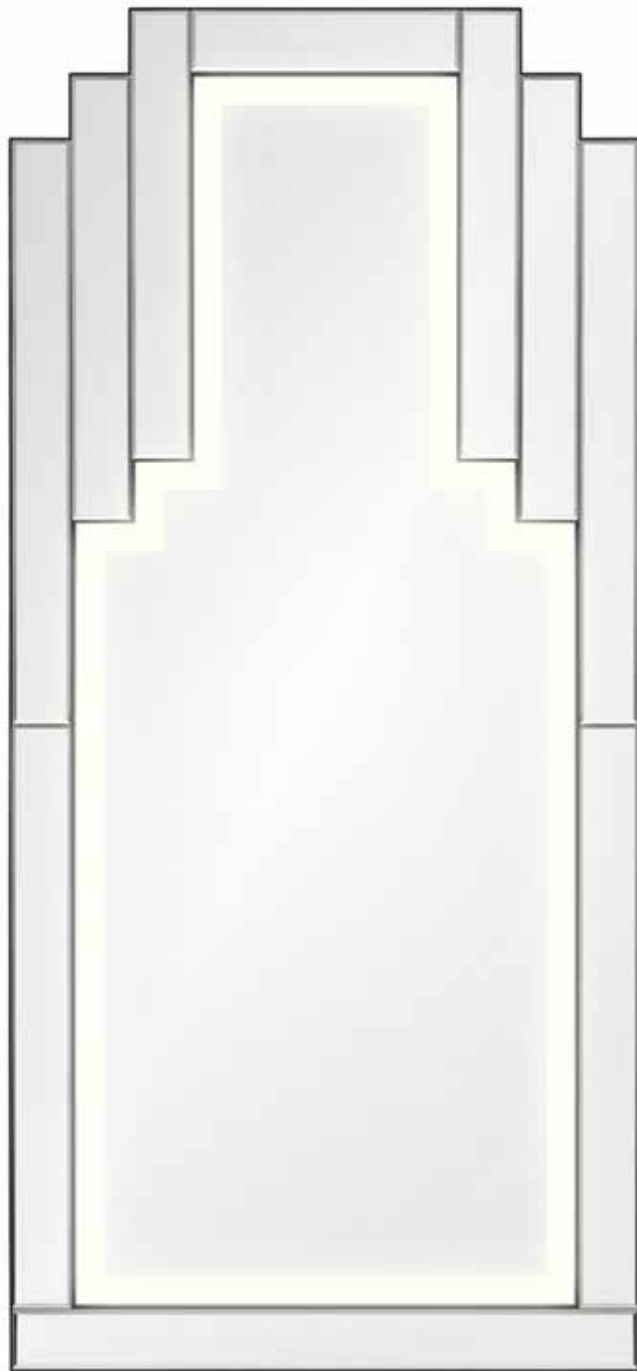

EDISON | MS15018  
DESCRIPTION: 2 INCH MIRROR  
STRIP INSET INSIDE FRAME.  
SHOWN IN 3000K



VAPOR | MS15545  
DESCRIPTION: BACKLIT MIRROR WITH  
PANELS OF ART, FROSTED GLASS AND  
MIRROR SHOWN IN 2700K



SPLATTER | MS15581  
DESCRIPTION: BACKLIT MIRROR WITH  
PANELS OF ART, FROSTED GLASS AND  
MIRROR SHOWN IN 3000K



HERTZ | MS13036  
 DESCRIPTION: BACKLIT  
 MIRROR WITH CUSTOM  
 FROSTED PATTERN  
 SHOWN IN 3000K



SOCKET | MS15025  
 DESCRIPTION: 2 INCH FROSTED  
 STRIPS AT PERIMETER OF EACH  
 MIRROR WITH AMENITY SHELF  
 SHOWN IN SILVER LEAF AND 2700K

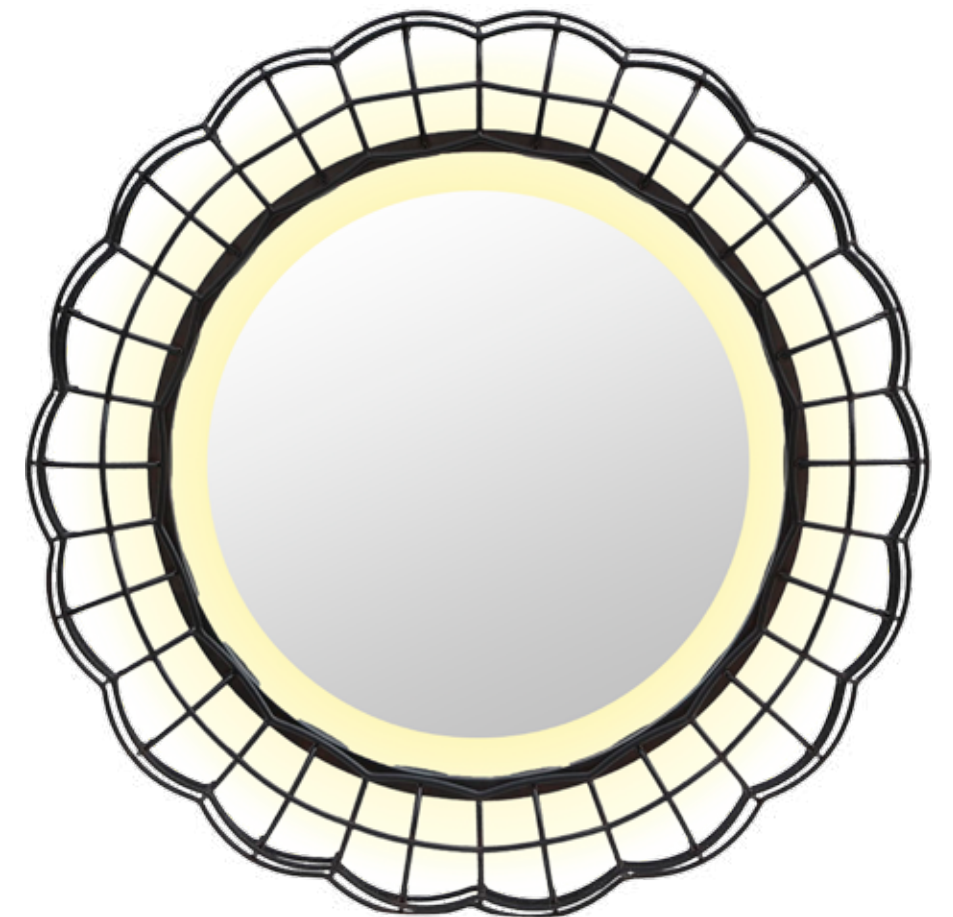

DAISY | MS15198  
 DESCRIPTION: DECORATIVE  
 METAL FRAME WITH  
 FROSTED STRIP AND HALO  
 LIGHTING SHOWN IN EBONY  
 (SHOWN IN 2700K)



**SPLASH | MS15192**  
DESCRIPTION: PAINTING  
ON MIRROR WITH HALO  
LIGHTING SHOWN IN 2700K



**EEL | MS15008**  
DESCRIPTION: SHAGREEN  
FRAMED BACKLIT MIRROR WITH  
2 INCH LIGHTED STRIPS ON  
EITHER SIDE SHOWN IN BRONZE  
SHAGREEN AND 2700K



**LUMEN | MS15621**  
DESCRIPTION: FRAMED MIRROR  
WITH LIGHTED STRIPS ON  
EITHER SIDE SHOWN IN SILVER  
LEAF AND 2700K



SWITCH | MS15208  
DESCRIPTION: PRINT ON  
DURATRANS SHOWN IN  
POLISHED CHROME AND 2700K

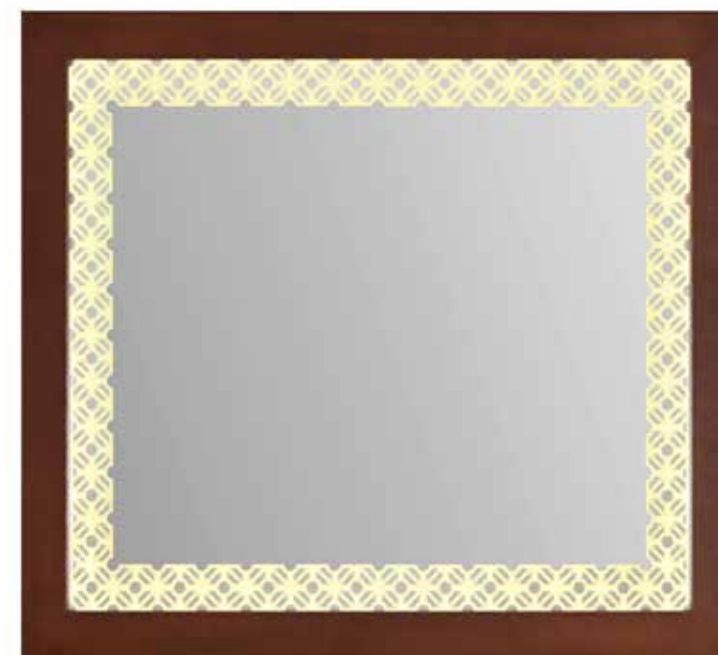

AMP | MS15607  
DESCRIPTION: FAUX LEATHER  
FRAMED MIRROR WITH  
CUSTOM BACKLIT ETCHED  
PATTERN SHOWN IN 2700K



SONIC | MS15655  
DESCRIPTION: WOOD FRAMED  
MIRROR WITH CUSTOM  
BACKLIT ETCHED PATTERN  
SHOWN IN 3000K





**THE ALEXANDRIA | MS15206**  
DESCRIPTION: CUSTOM COLORED BEVELED FRAME WITH DECORATIVE ETCHING DETAIL AND FROSTED LIGHT CHANNEL (SEE PAGE 98 FOR MORE INFORMATION AND SELECTIONS ON COLORED MIRROR) SHOWN IN 3000K

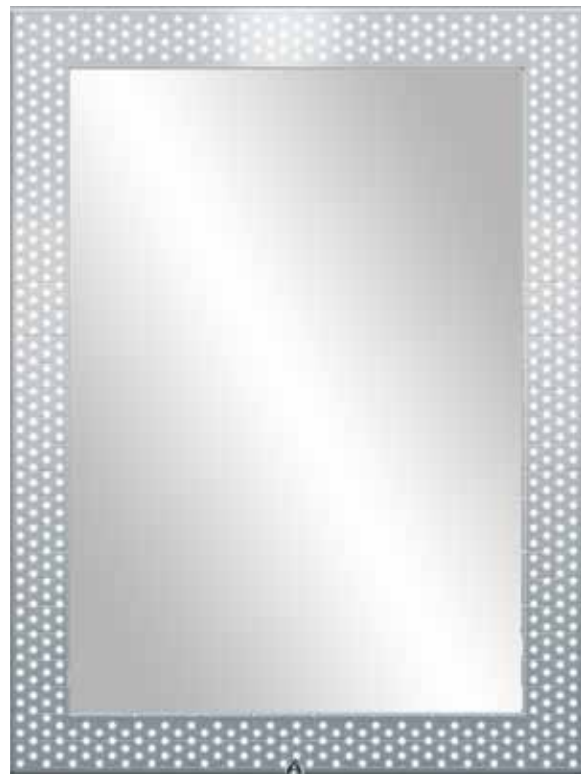

**THE BROADWAY | DS80005**  
DESCRIPTION: POLISHED CHROME FRAME WITH BACKLIT PERFORATED DETAIL

**THE TANGIERS | MS15650**  
DESCRIPTION: METAL MINIMALIST FRAME WITH 1 INCH REVEAL AND LED LIGHTING. POWER BUTTON INSET TO THE FACE OF THE MIRROR. SHOWN IN 3000K



**TOOL BOX**  
 Customize any of our frames to create your hotel signage (backlit or other)



**THE FAIRFAX | DS80002**  
 DESCRIPTION: POLISHED CHROME FRAME WITH GOOSENECK LAMP AND FROSTED ROOM NUMBERS



**THE FRANKLIN | DS80003**  
 DESCRIPTION: POLISHED CHROME FRAME, DIAMOND AND ONYX MIRROR WITH ROOM NUMBERS BACKLIT



**THE GRAND | DS80004**  
 DESCRIPTION: BACKLIT MIRROR ENCASED IN ORNATE FRAME

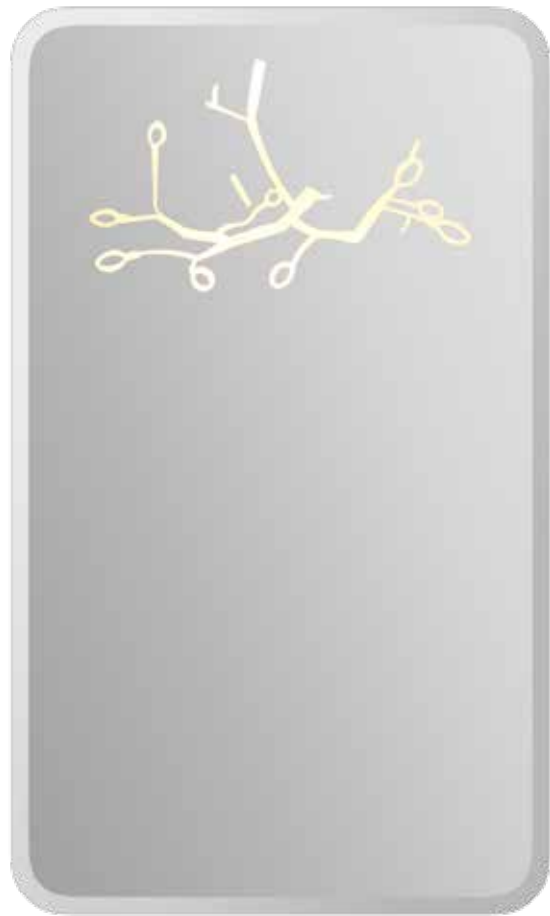

HYBRID | MS15120  
DESCRIPTION: ILLUMINATED  
BRANCH WITH BEVELED EDGE AND  
HALO LIGHTING SHOWN IN 2700K



WIRE | MS15121  
DESCRIPTION: ILLUMINATED BIRD  
CAGE WITH BEVELED EDGE AND HALO  
LIGHTING SHOWN IN 2700K

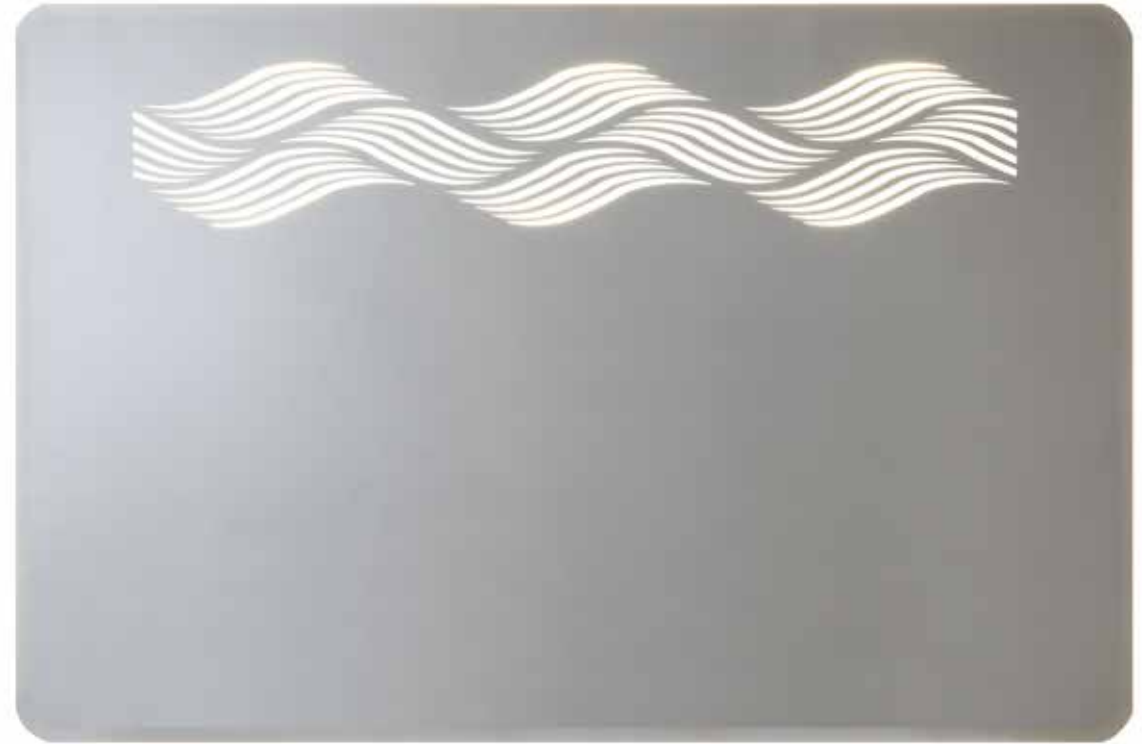

WAVELENGTH | MS15646  
DESCRIPTION: ILLUMINATED  
MIRROR WITH DECORATIVE  
PATTERN SHOWN IN 3000K.

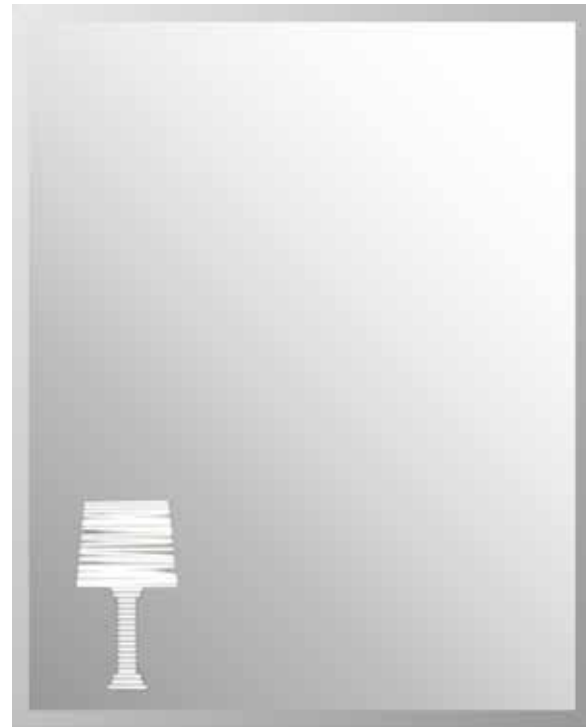

**KELVIN | MS15212**  
DESCRIPTION: ILLUMINATED  
TABLE LAMP WITH BEVELED  
EDGE SHOWN IN 3000K



**FLUX | MS15119**  
DESCRIPTION: FRAMED MIRROR  
WITH ILLUMINATED PENDANT.  
ADD A TABLE OR SHELF



**SURGE | MS15011**  
DESCRIPTION: ILLUMINATED  
MIRROR WITH DECORATIVE  
PATTERN

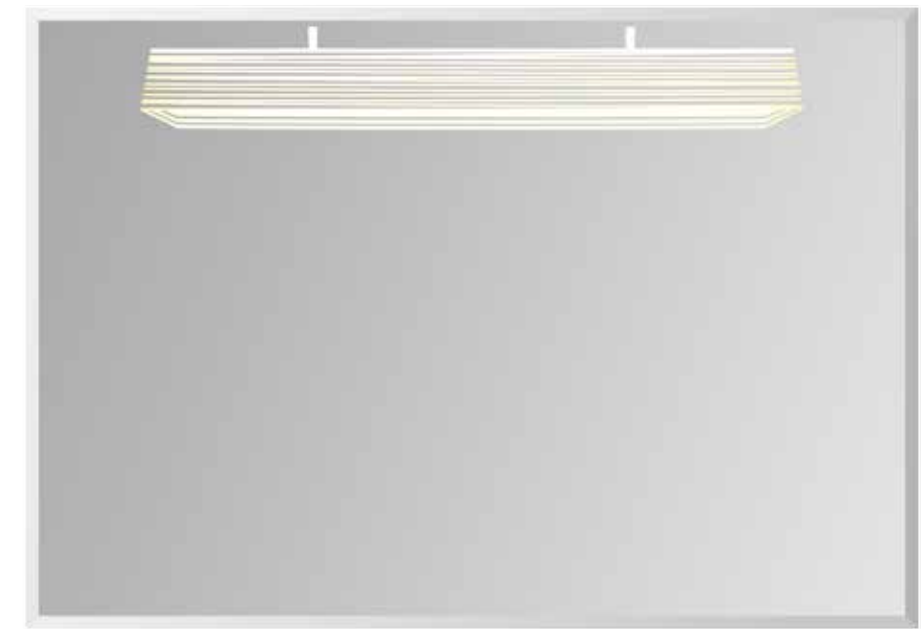

**STATIC | MS15651**  
DESCRIPTION:  
ILLUMINATED PENDANT  
WITH BEVELED EDGE  
SHOWN IN 2700K



BN-16004  
DESCRIPTION: ILLUMINATED  
CIRCLES SHOWN IN EBONY

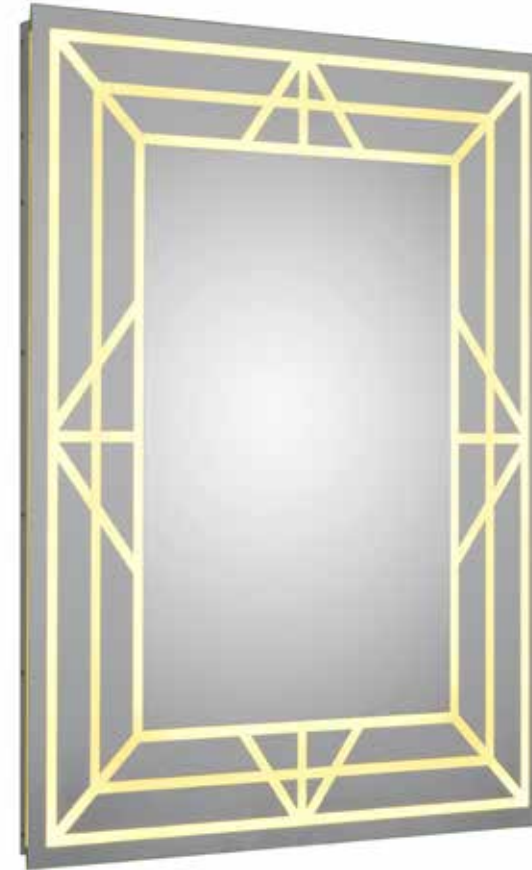

BN-16003  
DESCRIPTION: ILLUMINATED  
GEOMETRIC BACKLIT MIRROR



BN-16005  
DESCRIPTION: OVERLAID INTERLOCKING  
CIRCLES ON CLEAR MIRROR WITH  
INTERIOR LIGHTING

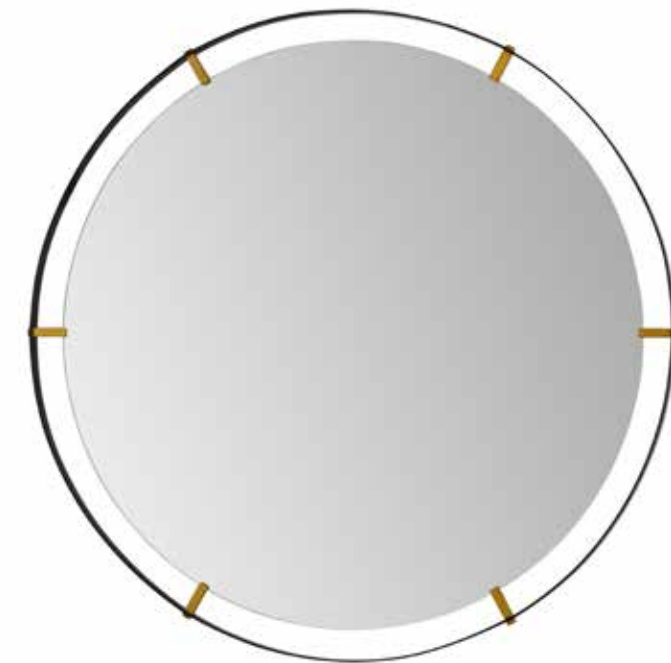

BN-16001  
DESCRIPTION: BLACK METAL  
FRAME WITH GOLD BAND  
DETAIL



**RING OF FIRE | MS15687**  
DESCRIPTION: BACKLIT MIRROR WITH 3 INCH FROSTED PATTERN AROUND PERIMETER AND MAKEUP MIRROR WITH SWAROVSKI DETAIL SHOWN IN 3000K.

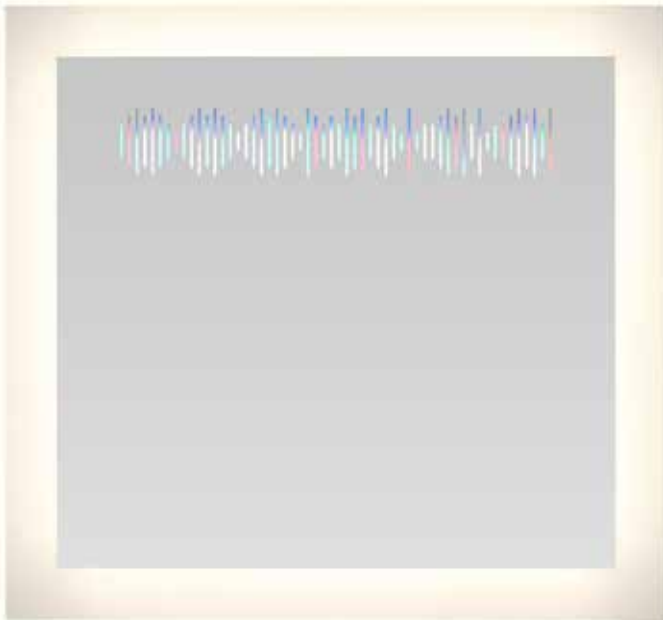

**PULSE | MS15689**  
DESCRIPTION: BACKLIT MIRROR WITH 3 INCH FROSTING AT PERIMETER AND A SOUNDWAVE PATTERN PULSING TO THE RHYTHM OF MUSIC SHOWN IN 3000K AND MUTLI-COLOR LED.



**CHECKPOINT | MS15683**  
DESCRIPTION: PRINTED SILHOUETTE WITH HALO LIGHTING SHOWN IN 3000K.

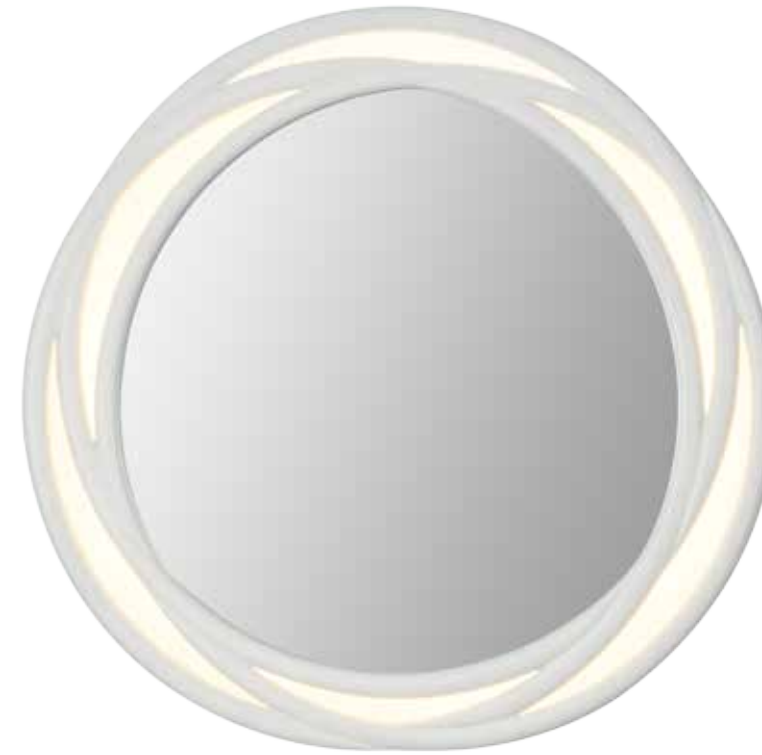

LASSO | MS15681  
DESCRIPTION: DECORATIVE  
BACKLIT FRAME SHOWN IN 3000K.

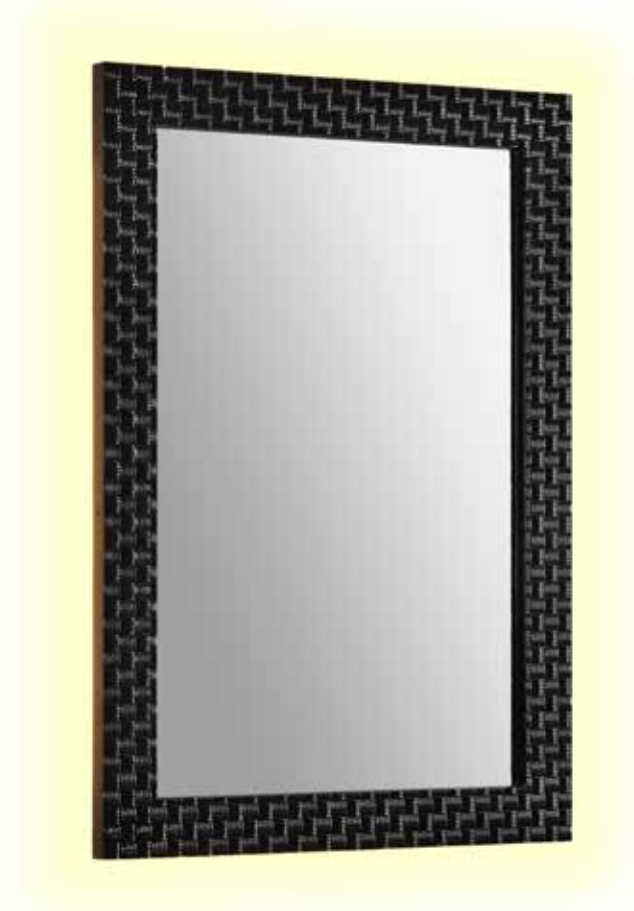

BEETLE | MS15682  
DESCRIPTION: FAUX BLACK  
RATTAN FRAME WITH HALO  
LIGHTING SHOWN IN 3000K

LINES | MS15690  
DESCRIPTION: DECORATIVE  
BACKLIT FRAME SHOWN IN 3000K.

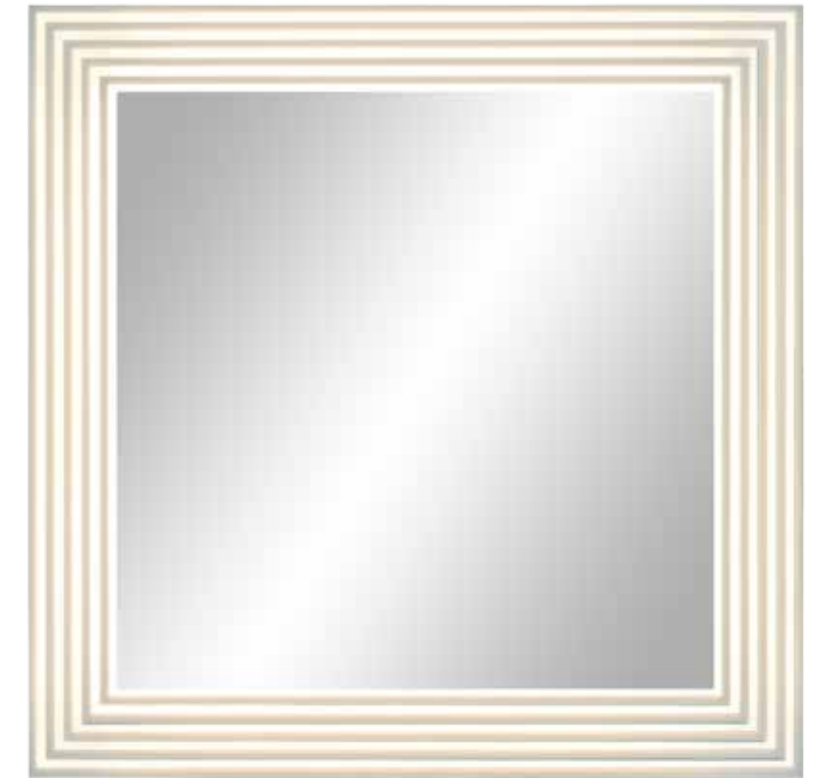

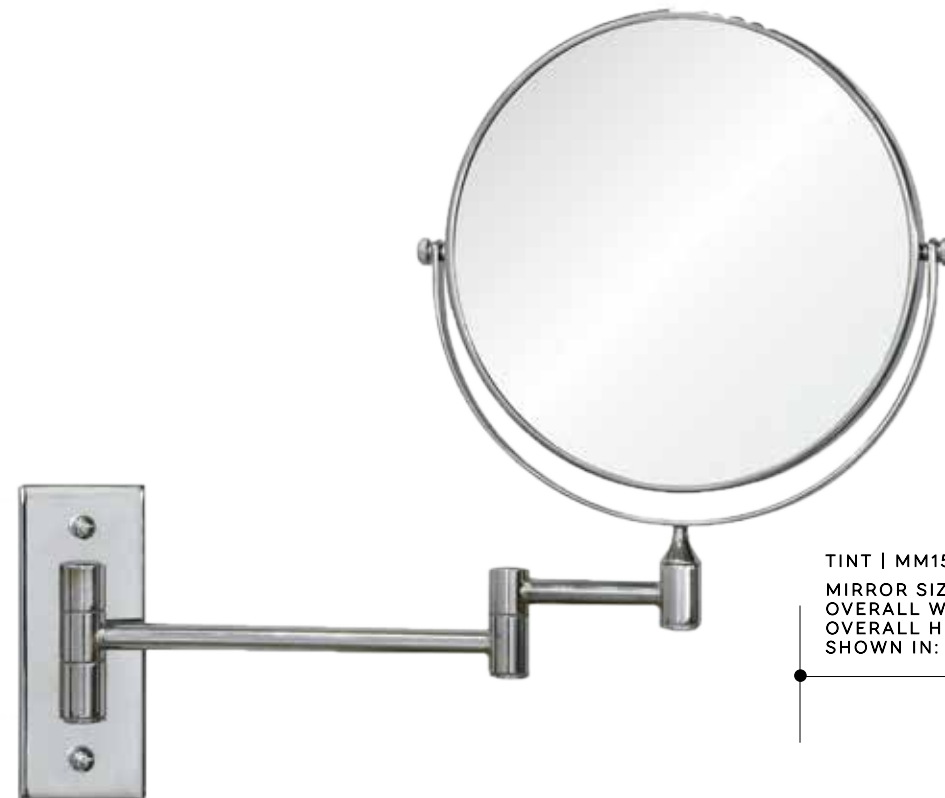
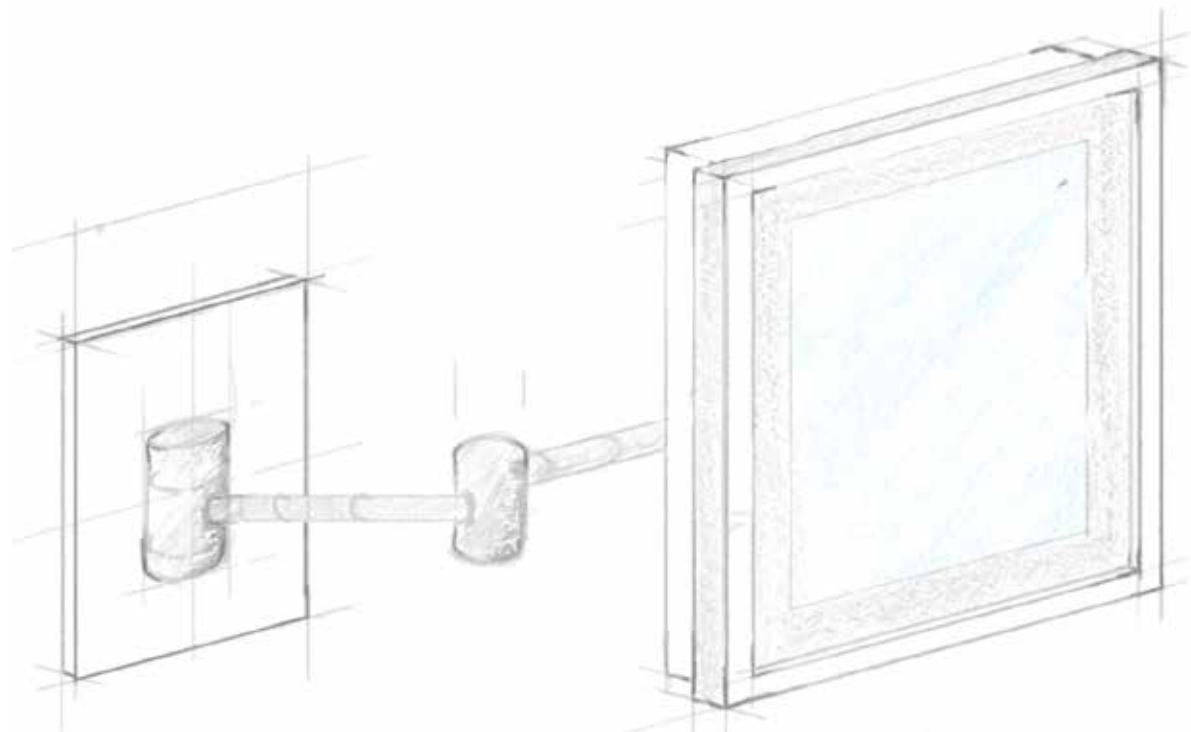

TINT | MM15203  
 MIRROR SIZE: 7.5" DIAMETER  
 OVERALL WIDTH: 17.5"  
 OVERALL HEIGHT: 12.5"  
 SHOWN IN: POLISHED CHROME

# OUR MAKEUP MIRRORS

Whether your property needs and the magnification (3x, 5x or 7x). standing, wall-mounted, or lighted For additional customization, please request more information from info@ perfect fit! Select the finish you desire mirrorimageinc.com.



PRIMER | MM15205  
 MIRROR SIZE: 5"X8"  
 OVERALL WIDTH: 5"  
 OVERALL HEIGHT: 12"  
 SHOWN IN: POLISHED CHROME



HIGHLIGHTER | MM15207  
 MIRROR SIZE: 6" DIAMETER  
 OVERALL WIDTH: 6"  
 OVERALL HEIGHT: 11.5"  
 SHOWN IN: POLISHED CHROME





CURLER | MM15208  
MIRROR SIZE: 7.5" DIAMETER  
OVERALL WIDTH: 9.5"  
OVERALL HEIGHT: 13"  
SHOWN IN: POLISHED CHROME



PALLETE | MM15213  
MIRROR SIZE: 8"X8"  
OVERALL WIDTH: 15.5"  
OVERALL HEIGHT: 12.5"  
SHOWN IN: POLISHED CHROME



POWDER | MM15212  
MIRROR SIZE: 5"X10.25"  
OVERALL WIDTH: 5"  
OVERALL HEIGHT: 15.5"  
SHOWN IN: POLISHED CHROME



BRONZER | MM15211  
MIRROR SIZE: 8"X8"  
OVERALL WIDTH: 8"  
OVERALL HEIGHT: 15.5"  
SHOWN IN: POLISHED CHROME



GLOSS | MM15199  
MIRROR SIZE: 10" DIAMETER  
OVERALL WIDTH: 10"  
OVERALL HEIGHT: 15.5"  
SHOWN IN: POLISHED CHROME



FALSIES | MM15202  
MIRROR SIZE: 8"X10"  
OVERALL WIDTH: 8"  
OVERALL HEIGHT: 10"  
SHOWN IN: POLISHED CHROME



LINER | MM15204  
MIRROR SIZE: 8"X8"  
OVERALL WIDTH: 8"  
OVERALL HEIGHT: 12.25"  
SHOWN IN: POLISHED CHROME



STAIN | MM15206  
 MIRROR SIZE: 7.5" DIAMETER  
 OVERALL WIDTH: 7.5"  
 OVERALL HEIGHT: 15.5"  
 SHOWN IN: POLISHED CHROME



LIPSTICK | MM15217  
 MIRROR SIZE: 6.5"X9"  
 OVERALL WIDTH: 6.5"  
 OVERALL HEIGHT: 14"  
 SHOWN IN: POLISHED CHROME



LASHES | MM15215  
 MIRROR SIZE: 8"X8"  
 OVERALL WIDTH: 16.5"  
 OVERALL HEIGHT: 8"  
 SHOWN IN: POLISHED CHROME



BRUSH | MM15200  
 MIRROR SIZE: 6.5" DIAMETER  
 OVERALL WIDTH: 6.5"  
 OVERALL HEIGHT: 8.25"  
 SHOWN IN: POLISHED CHROME



KABUKI | MM15198  
 MIRROR SIZE: 6" DIAMETER  
 OVERALL WIDTH: 7"  
 OVERALL HEIGHT: 10.75"  
 SHOWN IN: POLISHED CHROME



PENCIL | MM15220  
 MIRROR SIZE: 8"X8"  
 OVERALL WIDTH: 8"  
 OVERALL HEIGHT: 14"  
 SHOWN IN: POLISHED CHROME



FOUNDATION | MM15214  
MIRROR SIZE: 5"X8"  
OVERALL WIDTH: 8"  
OVERALL HEIGHT: 12.5"  
SHOWN IN: POLISHED CHROME

BUFFER | MM15650  
MIRROR SIZE: 5"X8"  
OVERALL WIDTH: 8"  
OVERALL HEIGHT: 24"  
SHOWN IN: POLISHED CHROME

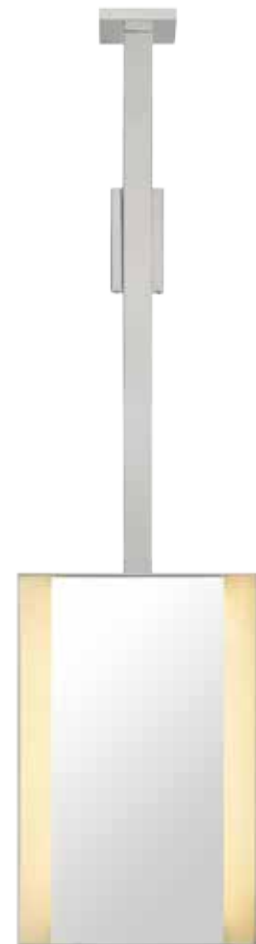

CONTOUR | MM15209  
MIRROR SIZE: 10" DIAMETER  
OVERALL WIDTH: 17.75"  
OVERALL HEIGHT: 12"  
SHOWN IN: POLISHED CHROME



SHADOW | MM15210  
MIRROR SIZE: 8" DIAMETER  
OVERALL WIDTH: 17.5"  
OVERALL HEIGHT: 8"  
SHOWN IN: POLISHED CHROME



BROW | MM15218  
MIRROR SIZE: 6.5"X9"  
OVERALL WIDTH: 17.5"  
OVERALL HEIGHT: 9"  
SHOWN IN: POLISHED CHROME



BLUSH | MM15216  
MIRROR SIZE: 5"X8"  
OVERALL WIDTH: 8"  
OVERALL HEIGHT: 9.75"  
SHOWN IN: POLISHED CHROME



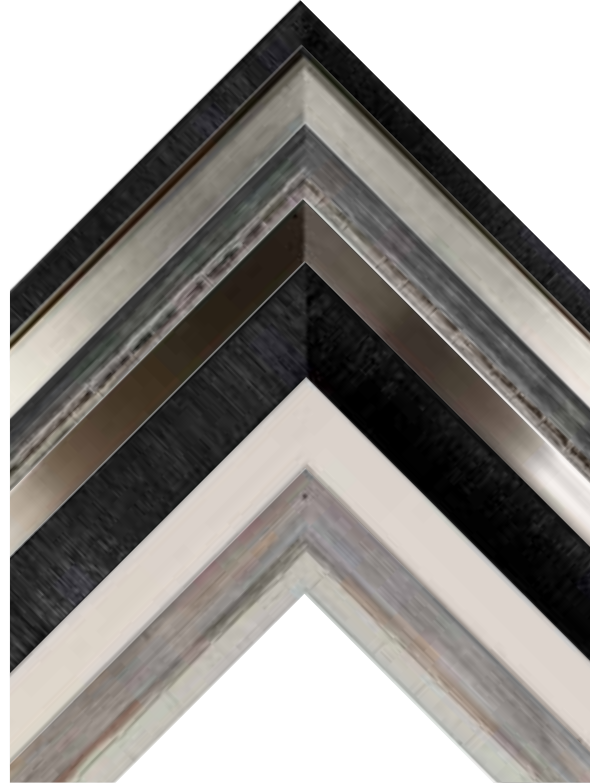

# QUICKSHIP PROGRAM

(Visit [www.mirrorimageinc.com](http://www.mirrorimageinc.com) for all quickship options)

Our QuickShip program was designed for the fast-paced nature of the hospitality industry. If you are pressed for time and need a fast turnaround, look no further! Our website ([www.mirrorimagehospitality.com/all/mirrors/quickship](http://www.mirrorimagehospitality.com/all/mirrors/quickship)) offers hundreds of options for you to choose from, which can be assembled to any size square or rectangle requested within 3-4 weeks. If you are looking for something in particular, send your specifications to [info@mirrorimageinc.com](mailto:info@mirrorimageinc.com). Mirror Image Home is a great resource for mirrors stocked in our Southern California warehouse. You can find their collection



15391



15392



15357



15393



15346



15344

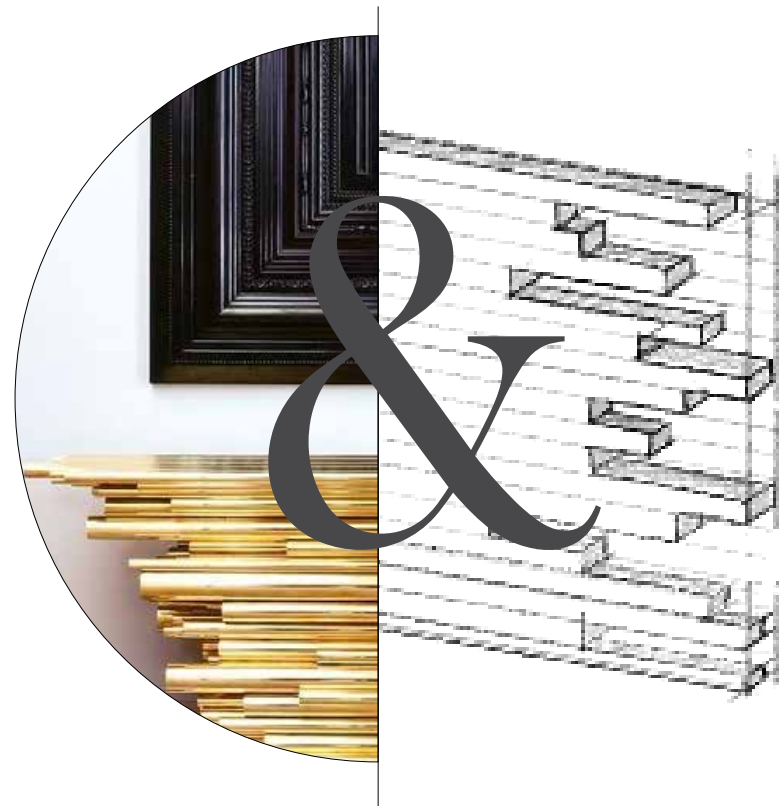

# OUR PROCESS

From beginning to end of each purchase order, we have adopted practices that make our clients jobs easier. Over the past 25 years we have fine-tuned our process and after each purchase order is submitted, our clients can expect a shop drawing within 48 hours. We have at least 15 volumes of finishes for fast and painless selections. Our project managers will work diligently with you in making your inspiration a reality!



ITEM NUMBER	SIZE	PAGE	ITEM NUMBER	SIZE	PAGE	ITEM NUMBER	SIZE	PAGE	ITEM NUMBER	SIZE	PAGE	ITEM NUMBER	SIZE	PAGE	ITEM NUMBER	SIZE	PAGE
10156	36X36	180	15077	36X52	133, 174	15503	30X36	106	15583	28X56	104	10302-GL	36X40	181	MS13040	36X48	220
10156	36X36	180	15079	18X42	151	15504	30X36	106	15584	36X60	129	10302-SL	36X40	181	MS13041	36X36	225
10201	36X60	49	15080	18X42	151	15506	36X36	63	15585	48X84	108	BN-16000	39X49	44	MS13042	36X36	231
10354	36X60	201	15082	39X30	88	15507	48X30	107	15586	24X90	95	BN-16001	36X36	45, 249	MS13043	28X40	217
10359	36X36	178	15083	30X40	207	15508	48X30	107	15587	28X36	75	BN-16002	26X34	43	MS13071	54X36	216
10362	36X36	178	15089	30X45	123	15509	48X30	107	15590	26X42	98	BN-16003	30X40	45, 249	MS15008	36X60	237
10369	30X34	197	15090	30X45	122	15510	36X72	163	15592	36X60	102	BN-16004	36X48	42, 248	MS15009	48X48	210
15000	36X28	79	15091	30X45	122	15513	48X48	47	15593	30X60	102	BN-16005	30X40	42, 248	MS15011	30X40	35, 146
15001	28X60	79	15101	36X46	185	15518	36X60	197	15594	36X42	51	BN-16006	26X26	41	MS15018	32X70	232
15002	36X48	90	15102	36X46	185	15519	36X36	179	15595	36X36	133	DS80002	10X6	32, 242	MS15025	42X40	235
15005	48X48	149	15103	36X46	185	15520	26X33	138	15596	30X30, 30X48	78	DS80003	10X6	32, 242	MS15119	30X72	37, 247
15007	45X72	50	15104	36X46	185	15521	26X33	138	15597	30X48	73	DS80004	60X36	33, 243	MS15120	30x48	39, 244
15010	68X42	89	15105	36X46	184	15522	26X33	139	15598	30X48	204	DS80005	30X40	28, 240	MS15121	30X48	39, 244
15012	28X72	156	15110	30X40	202	15523	26X33	139	15599	36X36	63	DS80008	36X84	218	MS15137	24X48	175, 226
15013	36X72	157	15111	30X72	202	15524	36X36	54	15600	38X78	96	DS80009	36X72	219	MS15178	36X36	216
15016	36X36	179	15112	36X36	134	15525	26X48	72	15603	36X60	173	KNA-17001	24X48	18	MS15179	30X48	211
15020	32X70	91	15113	30X60	195	15531	28X48	66	15609	36X48	99	KNA-17002	31X38	25	MS15192	72X72	77, 236
15021	26X72	206	15114	36X48	186	15532	36X60	130	15616	30X60	65	KNA-17003	31X42	18	MS15194	36X40, 54X36	215
15022	36X36	82	15115	36X48	187	15533	36X36	61	15617	48X48	131	KNA-17004	24X36	23	MS15198	36X36	235
15023	36X36	82	15116	30X60	195	15534	36X36	109	15623	36X36	64	KNA-17005	28X28	24	MS15203	17.5X12.5	255
15024	32X72	83	15118	26X36	207	15535	36X48	100	15625	20X36	204	KNA-17007	48X48	16	MS15206	60X36	29, 240
15028	42X40	144	15123	20X60	194	15536	60X48	174	15642	24X36	81	KNA-17008	30X40	19	MS15208	59X59	77, 238
15029	36X72	69	15127	36X72	192	15541	36X36	162	15647	36X48	191	KNA-17009	36X36	17	MS15212	30X40	36, 246
15030	28X36	69	15128	36X72	192	15542	48X36	166	15648	48X72	171	KNA-17010	33X88	19	MS15537	36X48	224
15031	32X46	113	15129	36X72	193	15543	36X72	171	15651	36X36	191	KNA-17012	36X36	22	MS15538	48X36	221
15032	32X46	112	15131	36X48	190	15544	30X72	124	15652	36X36, 36X60	167	KNA-17013	43X43	22	MS15545	60X36	76, 233
15033	32X46	112	15132	36X48	190	15546	36X72	153	15654	30X72	158	KNA-17014	36X36	24	MS15558	52X48	221
15034	68X42	88	15153	30X48	135	15549	24X60	165	15656	36X60	154	KNA-17015	36X36	21	MS15581	60X36	76, 233
15036	28X75	92	15154	30X72	135	15550	36X36	152	15657	30X48	147	MM15198	7X10.75	259	MS15602	24X36	227
15037	36X40	92	15161	30X72	68	15551	28X60	141	15658	30X60	150	MM15199	10X15.5	256	MS15607	48X48	239
15038	26X42	87	15161	30X72	119, 131	15552	48X48	128	15659	30X48	150	MM15200	6.5X8.25	258	MS15614	24X40	227
15039	26X42	84	15162	48X48	127	15553	36X36	142	15660	30X48	60	MM15202	8X10	257	MS15620	40X36	230
15040	26X42	87	15164	30X48	48	15554	30X72	65	15661	30X48	183	MM15204	8X12.25	257	MS15621	36X60	237
15041	26X42	84	15165	36X60	60	15555	28X60	168	15662	36X60	74	MM15206	7.5X15.5	258	MS15645	48X36	230
15042	30X72	86	15166	30X36	143	15556	36X36	56	15663	24X60	123	MM15207	6X11.5	255	MS15646	48X30	35, 245
15043	30X72	85	15168	36X60	48	15557	36X36	170	15664	48X40	159	MM15208	9.5X13	256	MS15649	36X36	212
15044	30X72	86	15170	24X48	66	15559	24X32	121	15665	30X72	155	MM15209	5X12	255	MS15650	60X80	30, 241
15045	30X72	85	15173	30X48	51	15561	36X48	167	15666	24X60	161	MM15209	17.75X12	261	MS15651	48X36	37, 247
15046	36X36	134	15174	36X36	80	15562	36X72	103	15668	48X40	159	MM15210	17.5X8	261	MS15655	48X36	239
15047	30X72	136	15175	48X48	153	15563	30X48	105	15669	36X72	160	MM15211	8X15.5	256	MS15681	36X36	10, 252
15048	30X72	136	15176	28X36	140	15564	48X48	93	15670	36X72	160	MM15212	5X15.5	257	MS15682	36X48	9, 252
15049	30X48	137	15180	30X36	53	15565	30X60	156	15671	36X36	126	MM15213	15.5X12.5	257	MS15683	36X84	15, 251
15050	30X48	137	15181	36X36	200	15566	48X40	148	15672	36X48	205	MM15214	8X12.5	260	MS15687	40X54	14, 250
15051	28X46	114	15182	48X48	127	15568	30X48	201	15674	28X48	67	MM15215	5X15.5	259	MS15689	48X48	14, 250
15052	28X46	117	15183	30X48	126	15569	30X60	199	15675	36X36	64	MM15216	8X9.75	260	MS15690	48X48	10, 253
15053	28X46	116	15186	30X36	182	15570	30X48	169	15676	36X54	165	MM15217	6.5X14	258			
15056	30X72	114	15187	48X30	146	15571	24X36	97	15677	24X36	176	MM15218	17.5X9	261			
15057	30X72	117	15188	24X36	164	15572	36X36	98	15678	36X36	149	MM15220	8X14	259			
15058	30X72	116	15189	26X72	119, 124	15573	30X42	199	15679	24X60	177	MM15650	8X24	260			
15059	30X72	115	15190	24X36	164	15574	30X48	203	15680	58X80	27	MS13030	36X36	223			
15063	36X72	52	15193	36X72	57	15575	36X36	144	15684	36X36	13	MS13031	48X48	213			
15064	30X48	55	15198	48X48	125	15576	36X48	145	15685	30X36	9	MS13032	48X48	214			
15069	16X24	163	15300	36X48	189	15577	30X40	101	15686	60X36	12	MS13033	48X40	217			
15074	36X36	196	15301	36X48	188	15578	24X54	100	15688	45"x45"	11	MS13034	48X48	212			
15075	24X48	173	15501	42X72	68	15579	30X48	183	20092	30X42	147	MS13036	48X48	234			
15076	24X48	175	15502	36X48	187	15582	48X24	74	75004	24X36	120	MS13037	36X72	222			

ITEM NAME	PAGE
AIDEN	179
ALEXANDER	66
ALICIA	93
AMP	239
ANDERSON	180
ANDERSON	180
ANGELIQUE	85
ANGORA	45, 249
ANNIE	79
ARCHER	212
ASHER	167
ATOM	227
AUTUMN	64
AVANI	137
BAILEY	192
BEAM	175, 226
BEDE	135
BEETLE	9, 252
BELLA	112
BENEDICT CANYON	19
BERMUDA	139
BEVERLY	21
BEVERLY GLEN	19
BIZU	82
BLACK PEARL	164
BLAKE	194
BLUSH	260
BOLT	223
BRIDGET	51
BRONZER	256
BROOKLYN	119, 124
BROW	261
BRUSH	258
BUFFER	260
BUTTERCUP	185
CABANA	138
CAESAR	97
CAMILLE	86
CAPTAIN	141
CASPER	73
CASTRO	171
CHAINS	147
CHANDLER	131
CHARGE	217
CHARLIE	116
CHAZ	109
CHECKPOINT	15, 251
CHER	101
CHEYNNE	204
CIRCUIT	213
CLAIRE	105
CLAUDE	84
CLEO	61
COCO	147
COLDWATER CANYON	24
COMPASS	133

ITEM NAME	PAGE
CONTOUR	261
COOPER	178
COPA	138
CORNELIUS	165
CORONA	74
CRYSTAL	155
CUBA	163
CURLER	256
CURRENT	224
DAHLIA	184
DAISY	235
DANE	137
DESTINY	192
DIANE	134
DINA	195
DIONNE	100
DIVA	201
DOLAH	145
DYLAN	157
EDEN	204
EDISON	232
EEL	237
ELLA	114
ELLEN	168
EMERSON	148
EMMA	114
ENERGY	210
EVE	78
FALL	107
FALSIES	257
FELIX	75
FLARE	227
FLASH	215
FLOWER	16
FLUX	37, 247
FORREST	158
FOUNDATION	260
FRANCIS	108
FRANCOIS	85
FRANKIE	199
FRENCHY	42, 248
FUEL	221
FUSE	231
GAGE	100
GALAXY	121
GARFUNKEL	207
GATSBY	91
GEAR	152
GEARS	11
GEMINI	60
GENE	166
GENEVIEVE	87
GERRY	55
GILBERT	48
GINO	72
GIO	60

ITEM NAME	PAGE
GLORIA	163
GLOSS	256
GRACE	181
GRACE	181
GRATE	153
GRID	217
GWEN	53
HARLEM	99
HARLEQUIN	45, 249
HARLOW	202
HARPER	117
HAVANA	41
HERTZ	234
HIGHLIGHTER	255
HIMALAYA	42, 248
HOLLY	83
HOTOT	44
HUDSON	130
HYBRID	39, 244
HYDE	202
IMPULSE	221
INDY	195
IVY	207
JAIME	81
JASMINE	185
JAX	174
JOLT	211
JOSEPHINE	98
JOSIE	48
JUDE	117
JULIAN	186
JULIETTE	92
JULIUS	66
JUNE	191
KABUKI	259
KATIE	102
KAYA	136
KELLY	135
KELVIN	36, 246
KEY	96
KIKO	197
KIT	51
KNOTS	133, 174
KNOX	127
KYLE	102
KYRO	167
LARRY	183
LASHES	259
LASSO	10, 252
LAUREL CANYON	22
LEO	190
LESTER	176
LEVI	171
LEX	88
LIEF	69
LINER	257

ITEM NAME	PAGE
LINES	10, 253
LIPSTICK	258
LIVE	216
LIYA	80
LONDON	89
LORENZO	187
LOUIS	165
LOUISA	86
LUCA	170
LUCY	88
LUMEN	237
LUNA	149
MADDOX	144
MADISON	177
MAKO	196
MARCELL	187
MARILLA	49
MARLEY	106
MASON	116
MEL	104
MELROSE	22
MIA	65
MICHAEL	150
MILA	150
MOANA	56
MONROE	128
MONTEGO	139
MOON	123
MOXY	156
NALA	63
NAUTILUS	140
NELLY	68
NELLY	119, 131
NEMO	142
NIKKI	156
NIKO	151
NINA	79
NIX	201
NORTH	203
OAK	159
ORCHARD	160
PACIFIC COAST HIGHWAY	17
PALLETE	257
PARIS	199
PARTICLE	222
PAX	144
PENCIL	259
PENELOPE	179
PERRY	52
PETAL	69
PIERRE	84
PLANKTON	124
PLUTO	122
POPPY	185
ITEM NAME	PAGE
POWDER	257

PRIMER	255
PULSE	14, 250
PUMA	169
PUMBA	126
QUINN	112
QUINN	113
RADIANT	225
RAE	54
RAIN	154
REBEL	200
RING OF FIRE	14, 250
RODEO	25
ROGUE	74
ROMEO	92
ROOSEVELT	205
RORSCHACH	9
ROXY	178
RYAN	173
SAGE	175
SAHARA	151
SAM	191
SAN VICENTE	24
SATURN	122
SEMMES	95
SEQUOIA	161
SHADOW	261
SHILOH	106
SHOCK	219
SHORT	220
SIMON	206
SIMONE	126
SKIPPER	125
SMASH	57
SOCKET	235
SOLAR	214
SONIC	239
SOPHIA	87
SOPHIE	115
SPARK	216
SPLASH	77, 236
SPLATTER	76, 233
SPOT	43
SPRING	107
STAIN	258
STATIC	37, 247
STEENA	67
STELLA	149
STEPHANIE	182
STITCH	188
STRIP BARS	12
SUMMER	64
SUNNY	134
SUNSET	23
SURGE	35, 146
SWITCH	77, 238
ITEM NAME	PAGE
TAI	103

TAILOR	189
THE ALEXANDRIA	29, 240
THE ALIBASTER	47
THE APOLLO	27
THE BROADWAY	28, 240
THE FAIRFAX	32, 242
THE FRANKLIN	32, 242
THE GRAND	33, 243
THE TANGIERS	30, 241
THERMO	218
THOMAS	146
TIGER	197
TIMBER	159
TINT	255
TOWNES	183
TREAD	153
TRITON	143
TUCKER	127
TULIP	185
VAPOR	76, 233
VEGA	120
VELOCITY	212
VENICE	18
VENUS	123
VIDA	162
VINCENT	68
VIVIAN	50
VIVIANA	65
VIVIENNE	129
VOLT	230
WADE	193
WATTS	230
WAVELENGTH	35, 245
WAVERLY	136
WHITE PEARL	164
WHY	13
WILLOW	190
WILSHIRE	18
WINSTON	98
WINTER	107
WIRE	39, 244
WYATT	173
YOSEMITE	160
YVES	82
ZAZU	63
ZOEY	90

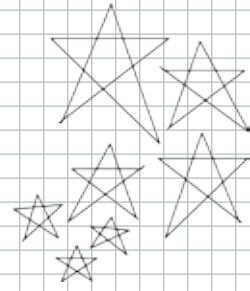

AT A GLANCE

- USA HEADQUARTERS IN LOS ANGELES, CA  
- ASIA HEADQUARTERS IN DONGGUAN, CHINA
- STANDARD LEAD TIMES VARY (CONTACT YOUR PROJECT MANAGER FOR MORE INFORMATION)
  - MODEL ROOM: APPROX. 45-60 DAYS
  - PRODUCTION: APPROX. 100 DAYS
- ALL FRAMED MIRRORS COME STANDARD WITH ANSI VINYL SAFETY BACKING, CLEAT AND LOCKING HARDWARE (UNLESS OTHER IS SPECIFIED)
- SHOP DRAWINGS WITHIN 48 HOURS OF P.O.
- FINISHES: SEE OUR WEBSITE TO SELECT FROM A MULTITUDE OF FINISHES, ORDER A FINISH BOOK, OR MATCH TO ANY PANTONE COLOR OR CONTROL SAMPLE
- ANTIQUE + COLOR MIRRORS (CAN BE CUT INTO ALMOST ANY SIZE OR SHAPE) - SOME STOCKED IN USA LOCATION
- QUICK SHIP ITEMS - SELECT ANY SIZE - SHIPS WITHIN 3-4 WEEKS OUT OF LA LOCATION

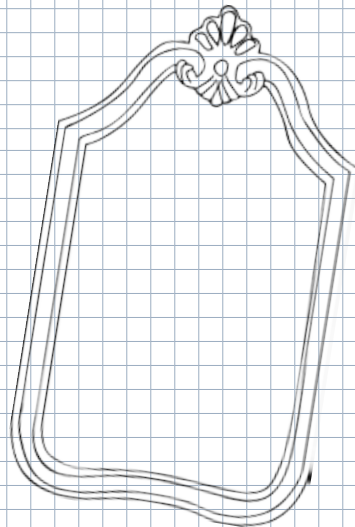

OUR  
TEAM

Our team is here to assist you! Visit [www.mirrorimagehospitality.com/contacts](http://www.mirrorimagehospitality.com/contacts) to find your local sales representative. The following is a list of email addresses for your reference.

Request a quote: [quoting@mirrorimageinc.com](mailto:quoting@mirrorimageinc.com)

Send a purchase order: [purchaseorders@mirrorimageinc.com](mailto:purchaseorders@mirrorimageinc.com)

Accounting: [accounting@mirrorimageinc.com](mailto:accounting@mirrorimageinc.com)

For all other inquiries, email [info@mirrorimageinc.com](mailto:info@mirrorimageinc.com)



