

Proudly Serving the Marine Industry for Over 40 Years

# 2017

## Quality Marine Accessories Catalog







Fellow boaters, fishermen, and industry partners,

Welcome to our 2017 boating accessories catalog! As we hit our 42nd anniversary in 2017, we are growing strong! With the overall boating market growing at around 5%, we have been on fire with 25% growth in 2016 and around 300% growth since the depth of the "great recession" in 2009. Our industry of boating is all about fun and family, and we are proud to be a part of it!



I am taking a different path this year with my catalog letter. I want to make sure our customers can visually recognize most of the great brands that make up the T-H Marine family of products, by sharing these brand logos with you:



ATLAS™ - America's #1 hydraulic jack plate.



HOT FOOT™ - Original foot throttle for boats.



G-Juice™ - World's #1 liquid fish care formula.



OXYGENATOR™ - World's only livewell oxygen generator.



AQUA-BLAZE

AQUA-BLAZE™ - Broadest top selling boat LED lights.



HydroWave® - Patented fish attracting sound device.



KVD KONG™ - World's strongest electronics mount.



TACKLE TITAN

TACKLE TITAN™ - Innovative tackle management.



CMC Marine™ - World's #1 selling tilt & trim plates.



G-FORCE™ - Trolling motor performance products.



Loc-R-Bar™ - Patented boat security lock and alarm system.



Z-LAUNCH™ - Patented watercraft launch cord.

We appreciate you checking out all of our products. Thank you for allowing T-H Marine to be a part of your success and fun, both in the factory and on the water.

Sincerely,  
Jeff Huntley  
President & CEO





Proudly Serving the Marine Industry for Over 40 Years



## PRICES:

Prices for items in this catalog apply to standard pack quantities only. All orders which do not reflect standard packaging quantities will be rounded to the nearest standard pack. T-H Marine will make every attempt to hold prices constant. Prices are subject to change due to uncontrollable cost increases.

## RETURNS:

T-H Marine products are carefully inspected and packaged and all efforts are made to insure that you receive goods of the quality that you expect. Returns are allowed for goods that have been determined to be defective in the manufacturing process. We will replace, repair or issue credit at our discretion. Returns must have prior authorization and an RGA# issued. Request for returns must be made to our office and must include the part number of the item, quantity of the item, reason for the return, date and T-H Marine invoice number. No deductions will be allowed on invoices without credit having been issued from T-H Marine Supplies, Inc. Any returned goods that are not covered by warranty will carry a restocking charge and must be approved before being returned. Freight must be prepaid on all returned goods. No returns will be allowed from OEM customers after 90 days from receipt of goods.

## DESIGNS:

All catalog items are subject to change or design improvement at any time during the catalog year.

## WARRANTY:

All T-H Marine Supplies, Inc. products are covered by a one year limited warranty to be free from defective material or workmanship, unless otherwise stated in product literature.

**T-H MARINE SUPPLIES, INC.**

200 Finney Drive  
Huntsville, Alabama 35824

Phone: 256.772.0164

Fax: 256.772.7135

Website: [www.THMARINE.com](http://www.THMARINE.com)

Email: [info@thmarine.com](mailto:info@thmarine.com)



**ALL PRODUCTS  
MADE IN U.S.A.**



## **T-H Marine Regional Sales Representatives**

### **Northeast**

*(Connecticut, Maine, Maryland, Massachusetts, New Hampshire, New Jersey, New York, Pennsylvania, Rhode Island, Vermont, Virginia, West Virginia)*

#### **Atlantic Marketing Company**

22 Bayview Ave. • P.O. Box 293 • Stonington, CT 06378

Phone: 860.535.8292 • Fax: 860.535.2960

Email: amoffice@amconet.com • www.amconet.com

### **Midwest**

*(Illinois, Indiana, Iowa, Kansas, Lower Michigan, Upper Michigan, Minnesota, Missouri, Nebraska, North Dakota, Ohio, Oklahoma, South Dakota, Wisconsin)*

#### **Midwest Outdoor Marketing**

Route 1, Box 741 • Hwy. 5 South • Camdenton, MO 65020

Phone: 573.317.1103 • Fax: 573.317.1022

Email: info@momarketing.com • www.momarketing.com

### **South**

*(Alabama, Arkansas, Florida, Georgia, Kentucky, Louisiana, Mississippi, North Carolina, South Carolina, Tennessee, Texas)*

#### **William F. Miller & Associates**

15 Music Square West • Nashville, TN 37203

Phone: 615.298.4444 • Fax: 615.269.4954

Email: info@williamfmiller.com • www.williamfmiller.com

### **West**

*(Arizona, California, Colorado, Idaho, Montana, Nevada, New Mexico, Oregon, Utah, Washington, Wyoming, British Columbia, Canada, Alaska, Hawaii)*

#### **West Coast Sales**

1341 Distribution Way #20 • Vista, CA 92081

Phone: 800.333.4163 • Fax: 760.734.4436

Email: jsanders@westcoastsales.com • www.westcoastsales.com

### **Canada**

*(All Canada except BC)*

#### **West Coast Sales**

1931 Woodbury Ave. • Portsmouth, NH 03801

Phone/Cell: 281.734.7488

Email: djdemoss@westcoastsales.com • www.westcoastsales.com

### **International**

#### **Brunger Export**

4901 N.W. 17th Way – Suite 600 • Fort Lauderdale, FL 33309

Phone: 954.928.1245 • Fax: 954.928.1644

Email: info@brungerexport.com • www.brungerexport.com





## New Products for 2017

### New Parts..... Page No.

Earth Magnetic Latches.....	2
Atlas™ Heavy Duty Hydraulic Jack Plate.....	9
Mr. Crappie Crappie Care.....	19
Mr. Crappie Bait Blaster Underwater Light.....	19
Molded Rod Racks.....	37
G-Force Eliminator Prop Nut™.....	38
G-Force Equalizer™.....	39
LANE BLASTER™ LED Trolling Motor Headlight.....	41
Oetiker® Standard & Side Jaw Pincers.....	44
High Output Underwater LED Fishing Light.....	48
Fully Encapsulated Underwater LED Light.....	49
Stainless Steel Oval LED Underwater Light.....	49
Extreme LED Underwater Lights.....	49
LED Side Docking Light.....	51
LED Navigation Lights – Combination Bow.....	52
LED Navigation Lights – Single Side Bow Lights.....	52
LED Flex Strip Bow Lights.....	53
LED Bow Light Combination Kit – Battery Operated.....	53
LED Stern Lights and Bases.....	54
Bimini Top Light.....	55
Snap Flex Bases.....	55
Snap Flex Stern Lights.....	55
High Intensity Oval LED Courtesy Light/Rock Light Kits.....	57
Pontoon LED Module String Light Kit – Blue.....	58
Pontoon LED Flat Flexible Ribbon LED Strip Light Kit – Blue... 59	
Pontoon LED Flat Flexible Ribbon LED Strip Light Kit – RGB Color Changing.....	59
LED Flat Rope Lights – RGB Color Changing.....	61
LED Flex Strip Lights with Track.....	62
LED Flex Strip Lights – Battery Operated.....	62
LED Flex Strip Lights – Mounting Track & Track Ends.....	62
LED Flex Strip Lights – Ultraviolet LED Strip Lights.....	63
Flexible LED Light Bar.....	63
LED Push-In Cockpit Light.....	65
Stainless Steel Indirect LED Courtesy Light.....	70

### New Parts..... Page No.

Low Profile Stainless Steel LED Dome Light.....	70
High Intensity Oval LED Courtesy Light/Rock Light.....	70
Cup Holder LED Accent Ring.....	72
LED Cup Holder Insert.....	72, 78
Speaker LED Accent Ring.....	72
Z-Launch™ Watercraft Launch Cord.....	73
YOLOtek - PowerStick™.....	74
YOLOtek - AquaStickPOWER™.....	75
YOLOtek - AquaStick™.....	75
Banshee™ Alarm Padlock.....	76
Folding Drink Holder.....	78
Suction Cup Lever Tie Down.....	80
24/27 Series Combo Battery Tray.....	81
Soft Molded Grab Handle with Stainless Steel Accent Rings... 88	
HydroWave® Product Insert.....	89-97
KVD Kong™ Extreme Electronics Mount.....	98
Kong™ Wave Tamer.....	98
Wave Away.....	98
Shock-Lock Mini Kong™ Electronic Mounts.....	99
Shock-Lock Dual Kong™.....	99
TACKLE TITAN™ Magnetic Lure Holder & Tackle Organizer.....	100
TACKLE TITAN™ MINI - Magnetic Lure Holder & Tackle Organizer.....	100
TACKLE TITAN™ LURE MANAGER - Magnetic Lure Manager Pair.....	101
TACKLE TITAN™ LURE MANAGER SYSTEM - Magnetic Lure Management System.....	101
Cook's Go-To Tackle Storage System.....	101
TACKLE TITAN™ Knife & Plier Holder.....	102
TACKLE TITAN™ Single Electronics Caddy.....	102
TACKLE TITAN™ Large Gear Caddy.....	102
TACKLE TITAN™ Single Drink Holder.....	102
12V Waterproof Battery Pack, Rugged Case.....	102
Peddle Paddle.....	103

Each year T-H Marine strives to bring exciting new products to the marine marketplace. This year is no exception. Take a look at this year's newest list of "Problem Solvers." We are excited that this year we have new products that not only solve problems but save labor as well. We are confident that you will find a solution for your needs.







## Hatches, Plates & Lids

**Lid Locks & Latches** ..... 2  
Anchor Handle Locks, Slam Latches, Magnetic Latches

**Hatches** ..... 3-5  
Designer Series™ Access Hatches, Sure Seal™ Access Hatches, Locking, Non-Locking, Vertical Access Doors, Drop-In Boxes, Tackle Boxes, Tackle Tray, Organizer, Glove Boxes

**Deck Plates** ..... 5-6  
Quick Release, Low Profile Twist Out, Screw Out, Pry Out, Screw Down

**Lid Accessories** ..... 6-7  
Storage Tubes, Lid Lifts, Restraint Straps, Lid Springs, Versatubes

## Performance

**Jack Plates** ..... 8-12  
Atlas™ Series Hydraulic Jack Plates, Atlas™ Heavy Duty Hydraulic Jack Plate, Atlas™ Series Digital Position Gauge, Atlas™ Series Hot Shot™ Jack Plates, Atlas™ Micro Jacker, A, Z-Lock™ Manual Jack Plate, High Performance, Mechanical, Fixed

**Trim Controls, Performance & Safety** ..... 13-16  
Emergency Ladder, Wheel Mount, Floor Mount, Transom Mount, Throttle Mount, Foot Throttles, Foot Throttle Mount, Transom Wedges, Engine Accessories, Stabilizers, Ignition Kill Switches, Skegs

## Plumbing & Drain

**Plumbing, Aeration & Livewell Accessories** ..... 17-24  
Pro Live Well Oxygenator™, G-Juice™, Pro Air Pumps, Max-Air™ Venturi, Baitwell Kits, Aerator Controls, Spray Heads, Wash Down/Spray Head Combo, Wash Down Fittings, Brite Plate™ Chrome Plated Parts

**Drains & Drain Plugs** ..... 24-29  
Cockpit Drains & Scuppers, All Purpose/Hatch Drains, Impact Drains, Oval Vents, Floor Drains, Splash Well Drains, Seat Pedestal Drains, Drain Plugs, Overflow Tubes, Livewell Drains, Garboard Drain

**Fittings, Filters & Screens** ..... 29-31  
Stainless Steel Mesh, Pump Screens, Drain Filters

**Thru-Hulls** ..... 32  
Straight, Extended Length, Ninety Degree, Threaded, Specialty Filters, Stainless Mesh Screens

**Plumbing Fittings** ..... 33  
Adapters, Reducers, Elbows, Tees, Gaskets

**Manifold Systems** ..... 34  
“T” Fittings, Adapter Fittings, Nipple Fittings, Reducer Fittings

## Rod Organization

**Custom Rod Organizers, Tubes, Rod Holding Devices** ..... 35-37  
Molded Faceplates, Oval Rod Tubes, OEM Rod Tubes, Mounting Faceplates, Tube End Caps, Rod Holders, Rod Grommets, Flanges, Rod Straps, Rod Holder Drains, Rod Tubes & Racks

## Trolling Motor Accessories

**Trolling Motor Accessories** ..... 38-41  
G-Force Eliminator Prop Nut™, G-Force Equalizer™ Motor Lift Assist, G-Force Silencer™ Vibration Pads, LANE BLASTER™ Trolling Motor Headlight, Troll-Tamer™ Trolling Motor Stabilizer Lock, G-Force Handle, Bounce Buster Coaster Circuit Breaker Kit, Trolling Motor & Charge Plugs, Foot Control Switches

## Rigging

**Motorwell to Engine and Rigging Accessories** ..... 42-46  
Zippered Rigging Sleeve, Flex Sleeving, Rigging Flanges & Hose, Hose Clamps & Cable Ties, Hydraulic Hose Stress Fitting, Cable Boots, Reinforcement Rings & Grommets, Wire Covers, Vent Flanges, Clamps, Wire Hose Hangers, Utility Grommets, Clam Shell Vents





**LED Lighting – AQUA-BLAZE** ..... 47-72  
 Underwater Lights..... 48-49  
 Spreader Lights..... 50-51  
 Navigation Lights..... 52-55  
 Light Kits..... 56-57  
 Pontoon Light Kits..... 58-59  
 Linear Lighting ..... 60-63  
 Courtesy Lights..... 64-70  
 Battery Operated Lights .....71  
 Cups and Speakers .....72

**Electronics & Lighting**..... 73-76  
 Z-Launch™ Watercraft Launch Cord, YOLOtek, Loc-R-Bar™ Boat Security System,  
 Two Way Boat Alarm, Banshee™ Alarm Padlock, Light Mounting Bracket, Light Clips,  
 Oval Courtesy Lights

**Quick Flush™ Outboard Flushing System**..... 77

**Holders & Restraint Devices**..... 77-81  
 Steer Stop™ Steering Lock, Trailing Clips, Motor Stik™, Drink/Cup Holder & Stabilizer,  
 Fuel Container Hold-Down Kit, Cooler Mounting Kit, All Purpose Strap, Prop-Stop™  
 Retainer, Paddle Keeper, Windshield Fastener

**Battery Trays**..... 81-83  
 Poly Strap Models, Stainless Steel Rod Models, Related Accessories

**Bungee/Shock Cord, Fuel System and Pontoon Boat Accessories** ..... 83-85  
 Gate Latches, Door Stops, Pontoon Splash Guard Deflector, Saf-T-Latch™,  
 Gate Holders, Rail Shims, Cleats, Fender Hanger Clips, Fuel Splash Guards

**Aluminum Boat Mounts/Rub Rail Fittings & Cleats** ..... 85-86  
 Steering Console Mount, Throttle Control Mount, End Caps, Butt Splices, Cleats

**Wash Down Stations & Coiled Hoses** ..... 86

**Boating Accessories**..... 86-88  
 Vinyl Caps, Prop Wrench, Anchor Retrieval System, Aqua Clips, Grab Handles

**Fishing Accessories**..... 88-103  
 G-Force Culling System, Money Pole™ Lure Retriever .....88  
 HydroWave® Marine Audio Technology - Product Insert..... 89-97  
 KVD Kong™, Kong™ Wave Tamer, Wave Away .....98  
 Shock-Lock™ Mini-Kong™, Dual Kong™ .....99  
 TACKLE TITAN™ Lure Management Systems ..... 100-101  
 Cook's Go-To Tackle Storage System.....101  
 TACKLE TITAN™ Fishing Accessories .....102  
 Peddle Paddle .....103

**CMC Products**..... 104-110  
 CMC Hydraulic Power Lift Jack Plates, CMC Manual Power Lift  
 Jack Plates, CMC Static Set Back Plates, CMC Accessories,  
 CMC Tilt 'N' Trim Units, CMC Transom Spacers & Clamp Adapters,  
 CMC Breakaway Unit

**Alphabetical Index**..... 111-115  
**Part Number Index** ..... 116-120

## LED Lighting

## Boating & Marine Accessories

## Fishing Accessories

## CMC Jack Plates & Trim Units

## Indexes





## Anchor Handle Locks

- Easy Grip “Two Finger” Handle
- For Lids Up to 3/4” Thick
- Fits 2-3/8” to 2-1/2” Hole
- Waterproof “O” Ring Seals

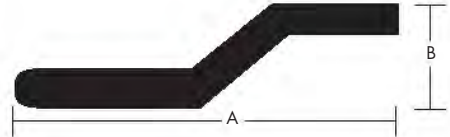

Part #	Type	Body Color	Handle Color
AL-1	Locking	Black	Black
AL-2	Locking	White	White
ALC-1	Locking	Black	Chrome
ALCN-1	Non Locking	Black	Chrome
ALC-2	Locking	White	Chrome
ALCN-2	Non Locking	White	Chrome
ALS-1	Lock Spacer for Lids Under 1/2” Thick		
Cams/Zinc	Type	“A” (in)	B” (in)
CAM-ZA	Straight	2-1/4”	
CAM-ZCXL	Offset	3-1/4”	1”
KEY-2	Replacement Key for AL Models		

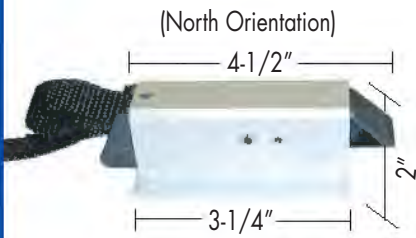

## Deck Lid Slam Latches

- Web Strap Pull Release with 32” Strap
- Unit Ships Complete with Striker
- Models to Orient in 2 Directions



Part #	Description
DLSL-1N	Deck Lid Slam Latch - North
DLSL-1S	Deck Lid Slam Latch - South



## Nautical Slam Latches

- Low Profile Oval Design
- UV Stable – Corrosion Resistant
- Stainless Steel Striker Plate
- Fits 2” Round Hole

Part #	Material Thickness	Color
NFSL-5-1	1/16” to 7/8”	Black
NFSL-5-2	1/16” to 7/8”	White



Closed

## Earth Magnetic Latches



- Powerful Magnetic Attraction
- Holds Lids and Doors Securely
- Encased in Plastic – Won’t Rust or Corrode

Part #	Description
MAGHL-2-DP	Earth Magnetic Latch - 1 pr



Open



## Designer Series™ Access Hatches

- Cam Style Locks Hold Lid Securely
- Positive Lid Seal for Water Tight Fit
- Hidden Fasteners in Frame
- Stainless Steel Hinges
- Structurally Engineered “Walk On” Lids
- Sizes for All Uses — Vertical or Horizontal
- Deck Seal Optional
- Height Above Deck — 5/8”
- Locking Hatches feature Stainless Steel Lock — Prevents Unauthorized Access



Rope Locker Slot can be installed in any size hatch — Call for ordering information.

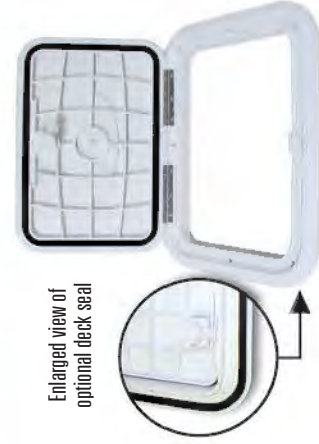

Non-Locking Models	Removable Door	Locking Models	Outside	Inside	Cut-Out
HDSS-0714-X		HDSSL-0714-X	7-1/2" x 14-1/4"	4-5/8" x 11-1/4"	5-1/8" x 11-7/8"
HDSS-1115-X	HDSS-1013-X-REM	HDSSL-1115-X	10" x 13"	6-3/4" x 9-3/4"	7-1/8" x 10-1/8"
HDSS-1119-X	HDSS-1119-X-REM	HDSSL-1119-X	11" x 15"	7-5/8" x 11-5/8"	8-1/4" x 12-1/8"
HDSS-1317-X	HDSS-1317-X-REM	HDSSL-1317-X	10-7/8" x 18-7/8"	7-5/8" x 15-1/2"	8-1/4" x 16-1/8"
HDSS-1324-X	HDSS-1324-X-REM	HDSSL-1324-X	12-7/8" x 16-7/8"	9-5/8" x 13-1/2"	10-1/8" x 14-1/8"
HDSS-1330-X	HDSS-1324-X-REM	HDSSL-1330-X	12-7/8" x 23-3/4"	9-5/8" x 20-1/2"	10-1/8" x 21-1/8"
HDSS-1620-X	HDSS-1330-X	HDSSL-1620-X	12-7/8" x 29-3/4"	9-5/8" x 26-3/8"	10-1/8" x 27"
		HDSSL-1620-X	16" x 20"	12-5/8" x 16-5/8"	13-1/8" x 17"

"X" in Part # Denotes Color Code: 1=Black 2=Polair White 3=Sand Shell 7=Light Gray

## Designer Series™ Glove Boxes

- Cam Lock — Holds Lid Securely
- Positive Lid Seal for Water Tight Fit
- Stainless Steel Hinges
- Hidden Fasteners in Frame
- Push Button Lock with Lift Tab
- Easy to Open — Locks Securely
- Prevents Unauthorized Access



Part #	Description	Outside Dim	Inside Dim	Cut Out Dim
GDSS4-0714-X	Glove Box - Non Locking	7-1/2" Wx14" L	4-5/8" Wx11-1/4" L	5-1/2" Wx12" L
GDSLPB4-0714-1	Locking Glove Box-Black	5-1/2" Deep	5" Deep	

"X" in Part # Denotes Color Code: 1=Black 2=Polair White





## Designer Series™ Tackle Centers

- Locking Versions Available – Call for Details

Part # (w/ Trays)	Description
TDSS-0714-2T-X	7"x14" Tackle Center - Includes Two 3600 Trays - 10" Deep
TDSS-1115-3T-X	11"x15" Tackle Center - Includes Three 3600 Trays - 10" Deep
TDSS-1317-4T-X	13"x17" Tackle Center - Includes Four 3600 Trays - 10" Deep

"X" in Part # Denotes Color Code: 1=Black 2=Polar White



## Sure-Seal™ Access Hatches

- Easy Access to Horizontal or Vertical Storage
- Watertight – Lid Overlaps Frame
- Dual Seals – Lid and Frame
- No Visible Fasteners
- Corrosion Free Integrated Hinge
- 180 Degree Door Opening
- Available in Lockable Version



Locking	Part Number		Dimensions		Cut-Out
	Non-Locking	Outside	Inside		
HATL-1115-X	HAT-1115-X	10-3/4" x 15"	7-3/8" x 11-1/4"	8-3/4" x 12-5/8"	
HATL-1324-X	HAT-1324-X	13 x 23-1/4"	9-1/2" x 19-5/8"	11 x 20-7/8"	

"X" in Part # Denotes Color Code - 1=Black 2=Polar White



## Tackle Tray Boxes

- Vacuum Formed Tackle Centers
- Includes Sure-Seal™ Hatch
- Popular Plano Style Trays



Part #	Description
TBOX -1115-3T-X	Box with 11" x 15" Hatch - With 3 Trays - 9" Deep*

"X" in Part # Denotes Color Code - 1=Black 2=Polar White

\*See SureSeal™ Access Hatch dimensions above for length, width and cutout



## Designer Series™ Vertical Access Door with Vent

- Slam Latch for Easy Opening and Closing
- Large 16"x20" Size
- Slotted Vent for Air Flow
- Great for Battery Compartments
- Stainless or Molded Latches Available
- Custom Options Available

Part #	Description	Outside Dim	Inside Dim	Cut Out Dim
HDSS-1620-"X"LV	Access Door w/ Vent	16"x20"	12-5/8"x16-5/8"	13-1/8"x17"

"X" in Part # Denotes Color Code: 1=Black 2=Polar White 3=Sand Shell 7=Light Gray



## Quick Release Deck Plate

- Cam Hatch Holds Secure
- Easy to Open & Close
- Hidden Fasteners in Ring
- Textured Finish
- Gripper in Lid Prevents Rotation

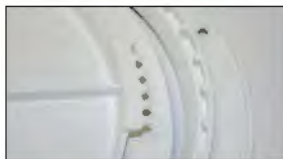

Part #	Description	Outside	Inside	Cut-Out
DPCAM-6-"X"	Quick Release Deck Plate 6" Dia	8"	5-1/8"	6-1/4"
DPCAM-8-"X"	Quick Release Deck Plate 8" Dia	10"	7-1/8"	8-1/4"

"X" in Part # Denotes Color Code - Use the Following Codes  
1=Black 2=Polar White 3=Sand Shell

## Low Profile Twist-Out Deck Plates

- Quick Twist-Out Lid - Fast Access
- Hidden Fasteners Provide Smooth Look
- Smooth Low Profile Lid - Overlaps Frame
- "O" Ring for Watertight Design

Textured	Smooth	Description	OD	Cut Out
DPSLP-4-X	DPSLP-4S-X	Twist-Out Deck Plate - 4"	5-5/8"	4-1/2"
DPSLP-5-X	DPSLP-5S-X	Twist-Out Deck Plate - 5"	6-7/8"	5-1/2"
DPSLP-6-X		Twist Out Deck Plate - 6"	8"	6-1/4"
DPSLP-8-X		Twist Out Deck Plate - 8"	10"	8-1/4"

"X" in Part # Denotes Color Code: 1=Black 2=Polar White 3=Sand Shell



## Sure-Seal™ Deck Plates

- Watertight - Lid Overlaps Frame
- Positive "O" Ring Seal
- Total UV & Chemical Stability
- No Visible Mounting Fasteners



Part Numbers		Dimensions		
Screw-Out Style	Pry-Out Style	(Diameter in inches)		
Textured	Textured	Outside	Inside	Cut-Out
DPS-4-X		5-3/4"	4"	4-1/2"
DPS-6-X	DPP-6-X	8"	6"	6-1/4"
DPS-8-X	DPP-8-X	10"	8"	8-1/4"

"X" in Part # Denotes Color Code - 1=Black 2=Polar White 3=Sand Shell JAVA=Light Tan



## Sure-Seal™ Oval Deck Plates

- Covers the Space of Two Deck Plates
- Positive Seal in Frame
- Inexpensive Alternative to a Hatch
- Watertight Pry-Out Lid Overlaps Frame
- Quick & Easy Access to Valves, Batteries, Fire Extinguishers or Fittings
- Hidden Fasteners in Frame
- Diamond Grid Non-Slip Pattern on Lid

Part #	Description	Dim - OD	Dim - ID	Dim - Cut Out
DPOVAL-6D-X	Oval Deck Plate	15-3/8" X 8-1/2"	13-1/8" x 6-1/8"	14-1/8" x 7-1/8"

"X" in Part # Denotes Color Code - 1=Black 2=Polar White 3=Sand Shell 7=Light Gray







## Designer Series™ Screw Down Deck Plates

- Tough Non-Corrosive Poly Material
- Textured Top – Smooth Tapered Edges
- Flanged to Fit Hole Securely

Black	White	Description	Min. Hole Size
DSSDP-1-1	DSSDP-1-2	Screw Down Deck Plate – 6" OD	4-1/2"
DSSDP-2-1	DSSDP-2-2	Screw Down Deck Plate – 8" OD	6-1/4"



## Screw Down Deck Plates

- Strong Super Tough Poly
- Attractive Matte Finish
- Inexpensive Alternative to Screw-Out Plates

Size (O.D.)	Part Number Based on Color of Deck Plate		
	Black	Off-White	Fish White
5-5/8"	SDP-1		SDP-1FW
8"	SDP-2	SDP-2W	SDP-2FW
10"	SDP-3		SDP-3FW



## Sure-Seal™ Versatubes™ – Low Profile

- New, Lower Profile Deck Plate Storage Compartment
- Larger 5" Diameter for More Room
- Store Your Valuables Protected from Rain & Spray
- Quick Open, Quarter-Turn Lid

Part #	Description	Color
VTLP-8-1	Versatube Low Profile Deck Plate Storage - 8" Deep	Black
VTLP-8-2	Versatube Low Profile Deck Plate Storage - 8" Deep	White

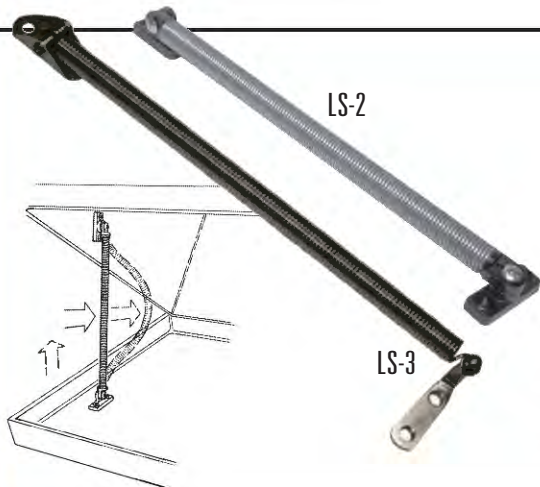

## Lid & Hatch Support Springs

- Stainless Spring Steel
- Deflects to Close
- Supports 10 to 20 lb. Lids

Part #	Size	Description	Supports
LS-2	7/16" x 8-1/2" L	Molded Nylon Ends	10 lbs
LS-2C	7/16" x 8-1/2" L	LS-2 w/Restraint Cable	10 lbs
LS-3	7/16" x 8-1/2" L	Offset Stainless ends	10 lbs
HS-1	5/8" x 12" L	Molded Nylon Ends	20 lbs



## Lid Lifts

- Injection Molded Poly
- Bottom Cup Prevents Water from Entering Box
- Large 3-Finger Opening on LLR's
- Easy to Install



Black #	Outside	Hole Size
LL-1	2-3/4" x 2-3/4"	2-1/8"
LLR-1	3-1/2" x 2-1/4"	2 ea. 1-1/2"

## Door Restraint Straps

- Restrains Doors, Hatches & Lids
- PVC Coated Stainless Steel Cable
- Stainless Steel "Eye" Ends
- Supports Up to 250 lbs., 750 lbs. for Heavy Duty



Part #	Heavy Duty	Description	Length
DRS-4		Door Restraint Strap	4"
DRS-5		Door Restraint Strap	5"
DRS-7		Door Restraint Strap	7"
DRS-9		Door Restraint Strap	9"
DRS-1	DRS-1HD	Door Restraint Strap	13"
DRS-16	DRS-16HD	Door Restraint Strap	16"
DRS-20		Door Restraint Strap	20"

• Custom straps available. Call for details.





# ATLAS™

## HYDRAULIC JACKING PLATE

**92%**  
of Professional  
Anglers Use  
ATLAS™



PERFORMANCE



Predrilled for  
Power Pole  
and Talon™  
Shallow Water  
Anchors

Predrilled for  
Hot Shot™ Hole Shot  
Plates

### Atlas™ Series Hydraulic Jack Plates

Atlas™ is an all new design to meet the demands of today's high performance outboards. This one piece design featuring the innovative Rod and Slot lifting system will handle the stresses from the heaviest and most powerful outboards, 300hp and 625 lb. max (283.5 kg), on the market today. All of the hydraulics are built into the jack eliminating the necessity of installing pumps and reservoirs inside the transom. This all new hydraulic unit is fast too... lifting from bottom to top in 8 seconds!

Check out these features:

- Self Contained Hydraulics
- Fast – 8 Second Lift Time • Rod and Slot Lifting Design
- Self Lubricating • Easy to Install – Easy to Service
- Installs in Half the Time of Comparable Jacks
- Lifetime Warranty on Frame & 3 Years on Actuator and Wiring Harness
- Hydraulic Rise - 5-3/4" – Total Rise - 8-1/4" to 9-3/4"
- Predrilled for Emergency Reboarding Ladder



Part #	Description	Setback
AHJ-4V-DP	Atlas Series™ Hydraulic Jack Plate	4"
AHJ-6V-DP	Atlas Series™ Hydraulic Jack Plate	6"
AHJ-8V-DP	Atlas Series™ Hydraulic Jack Plate	8"
AHJ-10V-DP	Atlas Series™ Hydraulic Jack Plate	10"
AHJ-12V-DP	Atlas Series™ Hydraulic Jack Plate	12"
AHJ-14V-DP	Atlas Series™ Hydraulic Jack Plate	14"
AHJACT-3-DP	Replacement Actuator	
AHJRELAYKIT-2-DP	Replacement Wiring Harness	
AHJSWITCH-1-DP	Replacement Switch	



# ATLAS™

THE ONLY CHOICE

**NEW!!**

## ATLAS™ Heavy Duty Hydraulic Jack Plate

T-H Marine's ATLAS™ Hydraulic Jack Plate is now available in a "HEAVY DUTY" upgrade. T-H Marine's ATLAS™ Hydraulic Jack Plate is the #1 selling jack plate in the world and the #1 Choice by fishing professionals and boat manufacturers. With the new ATLAS™ HEAVY DUTY, the product is available for applications on even larger outboards, up to 400 hp.

### 5 REASONS YOU SHOULD CHOOSE THE ATLAS™ HYDRAULIC JACK PLATE

- ATLAS™ is truly the best hydraulic jack plate in the world
- ATLAS™ is factory installed by more boat manufacturers than any other plate
- ATLAS™ is used by more professional fisherman than any other hydraulic jack plate
- ATLAS™ is the #1 selling hydraulic plate in the world – sold & serviced by more outlets
- ATLAS™ hydraulic actuator is made in the U.S.A. vs. our competitors being from China

### 6 WAYS THE ATLAS™ CHANGED HYDRAULIC JACK PLATES FOREVER

- ATLAS™ is made by T-H Marine/CMC, who were the FIRST to offer an actuator inside the jack plate – the competition copied
- ATLAS™ was the first plate to offer predrilling for shallow water anchors – the competition copied
- ATLAS™ was the first and only plate that did not require regular grease lubrication – the competition design cannot do that
- ATLAS™ was the first plate to include a heavy duty safety cable to protect boaters from engine entering cockpit upon failure
- ATLAS™ was the first plate to offer a very simple actuator replacement in the field
- ATLAS™ was the first major development in hydraulic jack plates in over a decade – spurring hydraulic jackplate improvement

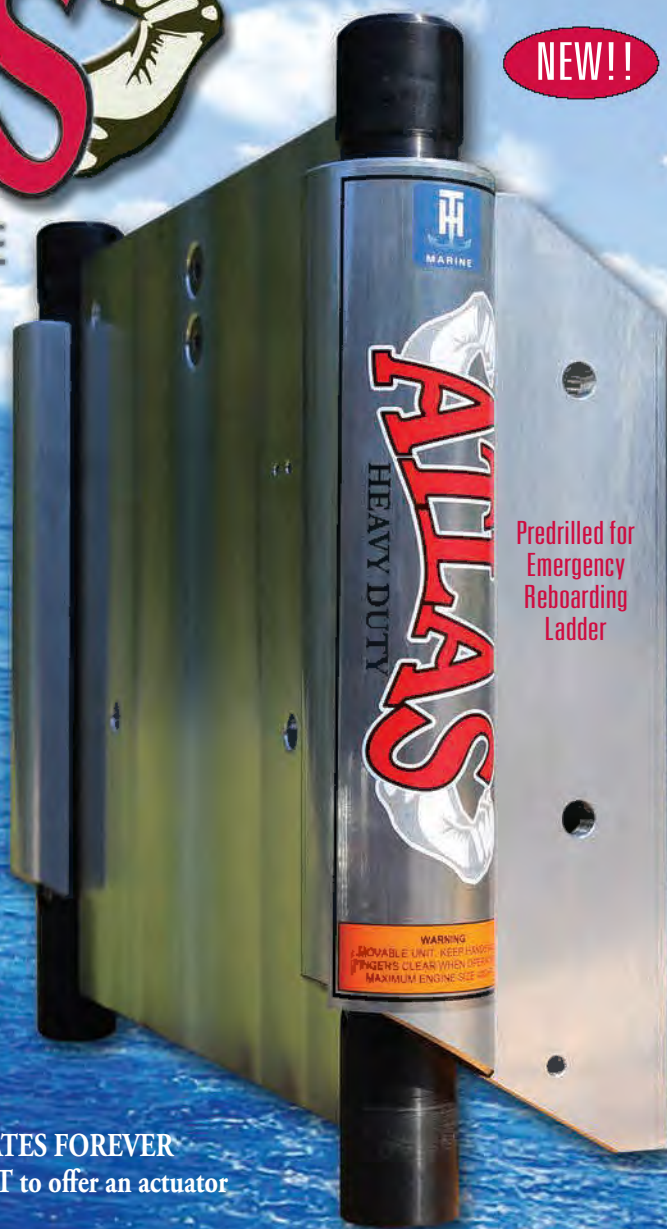

Predrilled for  
Emergency  
Reboarding  
Ladder

**Holes Pre-Drilled  
for 4 or 6 Engine Hole  
Motor Pattern**

Part #	Description	Setback
AHJ-4VHD-DP	Atlas™ Heavy Duty Hydraulic Jack Plate - 400 HP max	4"
AHJ-6VHD-DP	Atlas™ Heavy Duty Hydraulic Jack Plate - 400 HP max	6"
AHJ-8VHD-DP	Atlas™ Heavy Duty Hydraulic Jack Plate - 400 HP max	8"
AHJ-10VHD-DP	Atlas™ Heavy Duty Hydraulic Jack Plate - 400 HP max	10"
AHJ-12VHD-DP	Atlas™ Heavy Duty Hydraulic Jack Plate - 400 HP max	12"
AHJ-14VHD-DP	Atlas™ Heavy Duty Hydraulic Jack Plate - 400 HP max	14"





## Atlas™ Series Digital Position Gauge Kit

- All Digital Readout
- Each Number Indicates 1/4" Rise
- Numbers from 0 to 20
- All Atlas™ Jacks are Pre-drilled to Fit
- Black Face and Stainless Steel Face Gauges Available

FAGK-1-DP	Atlas™ Gauge Kit	Black Face	Fits 4" & 8" Models
FAGK-2-DP	Atlas™ Gauge Kit	Black Face	Fits 6"-10", 12" & 14" Models
FAGK-1SS-DP	Atlas™ Gauge Kit	Stainless Steel Face	Fits 4" & 8" Models
FAGK-2SS-DP	Atlas™ Gauge Kit	Stainless Steel Face	Fits 6"-10", 12" & 14" Models



## Atlas™ Series Hot Shot™ Hole Shot Plates

- Models to Fit All Atlas™ Jacks
- Provides Improved Hole Shot
- Reduces Water Drag at Take Off
- Reduces Porpoising

Models Marked -T have Side Imaging Transducer Cut-Out. Slot Fits Most Model SI Transducers.

Part #	Fits Atlas	Size
AHJHSP-4V-DP	AHJ-4V-DP	4"
AHJHSP-6V-DP	AHJ-6V-DP	6"
AHJHSP-8V-DP	AHJ-8V-DP	8"
AHJHSP-T-8V-DP	AHJ-8V-DP	8"
AHJHSP-10V-DP	AHJ-10V-DP	10"
AHJHSP-T-10V-DP	AHJ-10V-DP	10"
AHJHSP-12V-DP	AHJ-12V-DP	12"
AHJHSP-T-12V-DP	AHJ-12V-DP	12"
AHJHSP-14V-DP	AHJ-14V-DP	14"



## Atlas Micro Jacker™

- Perfect for Shallow Water Skiffs and Flat Boats
- Lightest on Market – 23 lbs
- Smallest Footprint Available – 14-5/8"W x 11-1/2"H
- Strong, Fast Actuator – 8 Seconds Top to Bottom
- 115hp Max and 425 Pounds Max
- Optional Clamp-on Motor Adapter



Part #	Description
AHJM-4-DP	Atlas Micro Jacker™
AHJM-CMA-DP	Micro Jacker Clamp-on Motor Adapter
ELCT0163	Replacement Actuator (Model #7342)
7014G	Replacement Wiring Harness

## Z-Lock™ Manual Jack Plates

- Exclusive Z-Lock Design Provides Maximum Strength
- Prevents Side Slippage and Movement
- Easily Adjusts Up or Down with Center Bolt
- Full 1/2" Aluminum Material for Strength
- Handles All V6 Outboards – 300hp Max
- Vertical Rise – 5"

Part #	Description	Setback
JPZ-4-DP	Z-Lock™ Jack Plate	4"
JPZ-6-DP	Z-Lock™ Jack Plate	6"
JPZ-8-DP	Z-Lock™ Jack Plate	8"
JPZ-10-DP	Z-Lock™ Jack Plate	10"
JPZ-12-DP	Z-Lock™ Jack Plate	12"



## Z-Lock™ Hot Shot™ Hole Shot Plates

- Improved Hole Shot
- Reduces Drag on Take Off
- Helps With Porpoising

Part #	Description	Fits
JPZHSP-6	Hot Shot™ Hole Shot Plate	JPZ-6-DP
JPZHSP-8	Hot Shot™ Hole Shot Plate	JPZ-8-DP
JPZHSP-10	Hot Shot™ Hole Shot Plate	JPZ-10-DP
JPZHSP-12	Hot Shot™ Hole Shot Plate	JPZ-12-DP

PERFORMANCE





## Pro Hi-Jacker™ Jack Plates

- High Strength Aluminum – 3/8" Thick
- One-Piece Design – Top Adjust
- Locking Bars Allow One Wrench Adjust
- Maximum 175hp Outboards
- 4" Vertical Adjustment

Part #	Description
JP-6PW-DP	Pro Hi-Jacker™ Jack Plates 6" setback, aluminum
JP-ADJ-BOLT	Center Adjustment Bolt & Collar - All Models



## Hi-Jacker™ Jack Plate

- 3/8" Aluminum – Two Piece Design
- Natural Aluminum Finish
- Dual Stainless Steel Adjustment Rods
- Maximum 150hp Outboards
- 6" Setback – 4" Vertical Lift

Part #	Description
JP-1A-DP	Hi-Jacker™ Jack Plate - Aluminum

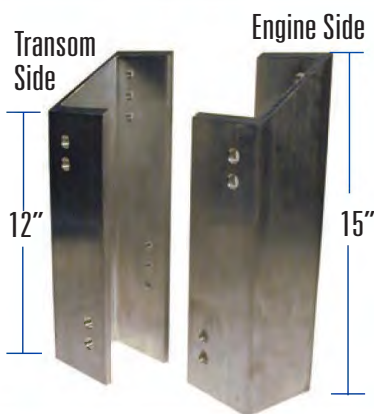

## Hi-Jacker™ Fixed Jack Plate

- Inexpensive Short Transom Fix
- Solid Aluminum Extrusion
- 3-Engine Mount Holes – 2-Transom Holes
- Total Vertical of 5-1/2 Inches – 4" Setback

Part #	Description	HP
JP-4FA-DP	Hi-Jacker™ Fixed Jack Plate	Max 150hp
JP-4FAHD-DP	Hi-Jacker™ Fixed Jack Plate	Max 300hp

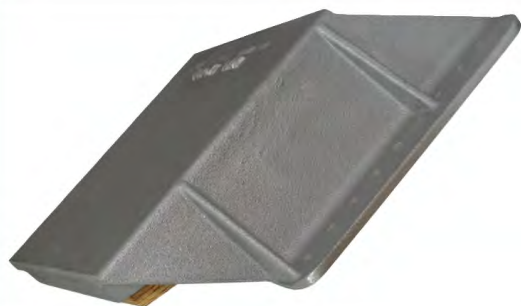

## Mini-Jacker™

- "Clamp Style" Small Outboard Jack Plate
- Cast Aluminum Bracket
- Marine Grade Transom Block
- 4" Setback – 3" Vertical
- Max Wt – 150lbs – Max HP-35

Part #	Description
MJ-1-DP	Mini-Jacker™ - For Outboards Only

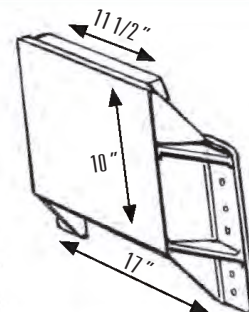

## Bolt Kit for Jack Plates

- For Mounting Outboard to Plate
- Kit Contains: 4 each 1/2" x 2-3/4" stainless steel long bolts  
4 each 1/2" lock nuts – brass with nylon insert  
8 each 1/2" flat washers – stainless steel
- Complies with Mercury and Yamaha Engine Mounting Specifications

Part #	Description
BK-1-DP	Jack Plate Bolt Kit - Brass nuts w/ nylon insert - Fine Thread - 1/2" - 20

## Emergency Reboarding Ladder

- Easily Rotates and Drops Down Into Ladder Position
- Meets NMMA Regs for Reboarding Ladders
- Strong All-Aluminum Design
- Snaps Up Securely into Slot When Not in Use
- Non-Slip Material on Both Steps



### Part # Description

EBL-1	Reboarding Ladder - Fits All Atlas™ Jack Plates
EBL-1-DP	Reboarding Ladder - Fits All Outboards - Port Side
EBL-2-DP	Reboarding Ladder - Fits All Outboards - Starboard Side
EBL-3-DP	Reboarding Ladder - Fits All Outboards - Port Side for Dual Power Pole Applications

## FingerFlex™

*The Ultimate in Trim Control for Hydraulic Helms*

- No Wheel Removal Required
- Wrap Around Bracket Installs in Minutes
- Positive Clicking Technology for Positive Touch
- Also Operates Power Jack Plates



Not for Tilt Steering



### Part # Description

FFTB-1-DP	FingerFlex™ Bezel Mount, Single
-----------	---------------------------------

## Steering Wheel Trim Control

- Rugged Urethane Coiled Cord
- Weatherproof Rubber Booted Switches
- Mounts Easily to Steering Wheel Spokes

Not for Use with Hydraulic Steering



### Part # Description

ST-1-DP	Steering Wheel Trim Control - 50 AMP
---------	--------------------------------------

## Transom Trim Control

- Puts Tilt & Trim Control Anywhere
- Weatherproof Control Switches
- Can Also Operate Power Jack Plates

### Part # Description

TTC-1	Transom Trim Control - 50 AMP
-------	-------------------------------



## Hot Trim™ Floor Mounted Trim Control

- Foot Operated Tilt & Trim Control
- Weatherproof Control Switches
- Prewired Matte Black Unit

### Part # Description

HT-1	Hot Trim™ Floor Mounted Trim Control - 50 AMP
------	---







## Trim Handle

- Puts Tilt & Trim Control Directly Onto Throttle Lever
- Weatherproof 50 Amp Switches
- Fits Pre 1979 OMC Control Handles

**Part # Description**

EJT-1-DP Trim Handle - 50 AMP

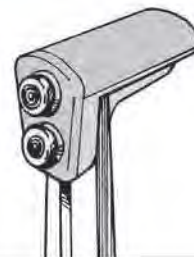

Cable not included.

## Hot Foot™ Pro Top Load Foot Throttle

- Improved Safety & Throttle Control
- Attractive Full Color Pedal Graphics
- Topside Cable Connections
- Patented Idle Stop for FICHT & Optimax
- Stainless Steel Hardware with Teflon Bushings
- Requires Longer Throttle Cable (Not Included)



**Part # Description**

HF-1T-DP Fits Johnson, Evinrude, Mercury & Mariner

HF-1CT-DP Fits Honda, Yamaha, Chrysler & Suzuki

HFS-1-DP Replacement Spring (all models)



Cable not included.

## Hot Foot™ Foot Throttle

- Number One Throttle on Market for Over 20 Years
- Provides Added Safety & Performance
- All Cast Aluminum – Stainless Steel Hardware
- Nylon & Teflon Bushings on all Critical Pivot Points
- Patented Idle Stop for FICHT & Optimax Engines
- Accepts All Engine Manufacturer Throttle Cables. Requires Longer Throttle Cable (Not Included)



**Part # Description**

HF-1-DP Universal Model - Fits All Marine Engines

HFS-1-DP Replacement Spring (all models)



## Hot Foot™ Slide Mount

- Easy Adjustment of Hot Foot™
- Stainless Steel Fasteners & Release Pin
- Allows 5" of Slide Adjustment

**Part # Description**

HFM-1 Hot Foot™ Slide Mount

## CMC Wedges/Set Back Spacers

- 2 Degree Wedges Provide Extra Positive or Negative Trim
- Designed to be Stacked Together to Act as Set Back Spacers
- 1/2" x 4" x 11-1/4" Size

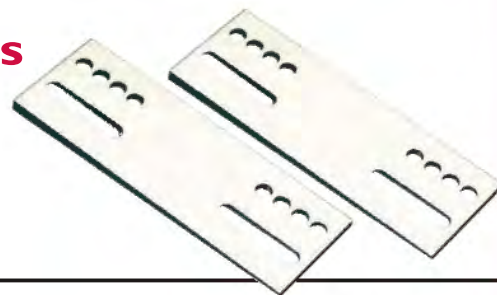

Part #	Description
#20122	2 Degree Reversible Transom Wedges

## Transom Wedges

- Fits All Standard 4-Bolt Patterns
- Full Contact Between Engine & Transom
- 2-1/4" W – 11-1/4" L – 1-1/16" to 3/16" Thickness

Part #	Description
TW-2	Transom Wedges - 1 Pair - 5 Degrees Negative Tuck
TW-3	Reverse Transom Wedge - 1 Pair - 5 Degrees Positive Tilt



## Transom Support Plates

- Distributes Stress of Engine Bolts
- High Quality Cast Aluminum
- Call for Customizing Program
- All Plates – 3/8" Thick

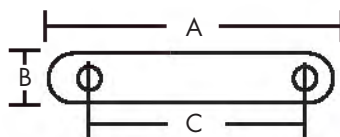

Part #	Description	A	B	C
TSP-1	Top Bolt Holes - Standard	15"	2"	13"
TSP-2	Lower Bolt Holes - Standard	12"	2"	10"
TSP-1C	Top Bolt Holes - Std - Custom	15"	2"	13"
TSP-1CP	Top Bolt Holes - Std - Custom & Painted	15"	2"	13"
TSP-7	For Yamaha 350 - four bolt holes	15-1/4"	3-3/4"	12-3/8"
#20022	Transom Washer Plate - Top	14-7/8"	2"	12-7/8"
#20032	Transom Washer Plate - Bottom	11-7/8"	2"	9-7/8"

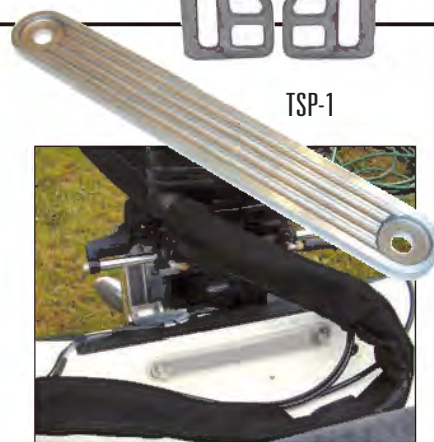

TSP-1



TSP-7

Plate can be customized with Logo and/or background painting. Call for details.



#20022



#20032

## Replacement Skegs

- Solid Cast Aluminum
- Welds to Lower Units
- Easily Cut to Shape

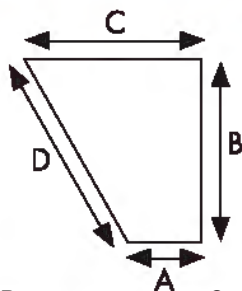

Part #	A	B	C	D
RS-1-DP	5-1/2"	6"	10-1/4"	9"
RS-2-DP	4-1/2"	5-3/4"	9-1/2"	10"
RS-3-DP	4"	4-1/4"	7-1/2"	7"
RS-4-DP	3-1/2"	6-1/2"	9-1/4"	10-1/2"

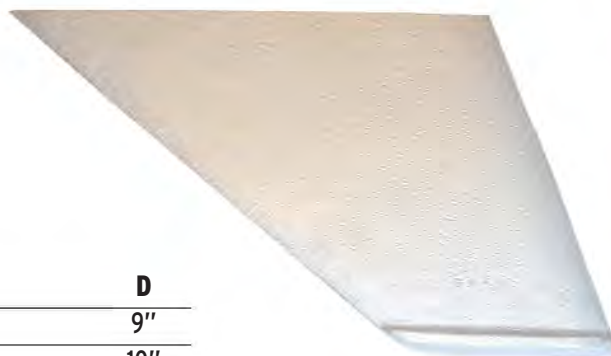





## Torque Tab

- Counters Torque Pressure on Wheel
- Inexpensive & Easy to Install
- Cast Aluminum – Stainless Hardware

Part #	Description
TAB-1-DP	Torque Tab

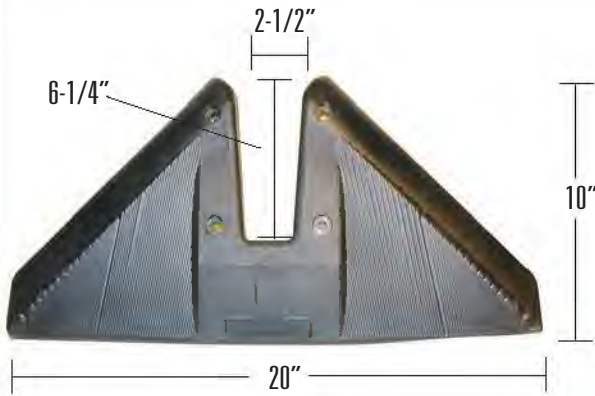
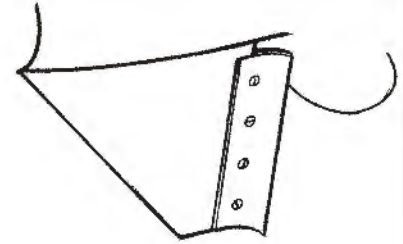

## Hydro-Tail™ Performance Stabilizer

- Planes Quicker – Reduces Cavitations
- One Piece Unit for Strength
- Fits Most Outboards & Stern Drives

Part #	Description
HYD-1-DP	Hydro-Tail™ Performance Stabilizer

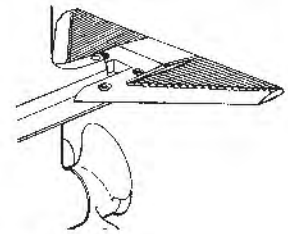

## Saf-T-Stop™ Ignition Kill Switches

- Meets All Requirements of Emergency Stop Switches
- Coiled Lanyard
- Isolated Circuits on Dual Units to Prevent Feedback
- Mounts Anywhere – Requires 1-1/2" Hole

KS-1	Saf-T-Stop™ Ignition Kill Switch	Single Outboard
KS-2	Saf-T-Stop™ Ignition Kill Switch	Single I/O
KS-12	Saf-T-Stop™ Ignition Kill Switch	Dual Outboard
KS-22	Saf-T-Stop™ Ignition Kill Switch	Dual I/O
L-4-DP	Saf-T-Stop™ Ignition Kill Switch	Replacement Lanyard



# THE OXYGENATOR™

BY T-H MARINE

[www.KeepFishAlive.com](http://www.KeepFishAlive.com)

## Pro Live Well Oxygenator™

- Produces 100% Pure Oxygen in Live Wells
- Easy Installation in Live Well – Flush Mount
- Keeps Catch Alive and Healthy
- 12 Volt – Less than 1 Amp
- Silent Running
- No Switch Required – Auto On/Off
- Rated Capacity – 20 Gallons

Part #	Description
02-BK3-DP	Pro Live Well Oxygenator™ - Packaged
02-BKM3	Pro Live Well Oxygenator™ - Bulk OEM



PLUMBING & DRAIN



# G JUICE

POWERED BY U2 PRO FORMULA

## Livewell Treatment Solution

G-Juice™ is a single phase, full functional water conditioner for use in fresh and salt water. Conditions water entering the live well, bait tanks, minnow buckets and in fish transport situations.

- Approved for use with THE OXYGENATOR™
- Non-Toxic to Humans, Pets & Aquatic Life
- Removes Nitrites, Ammonia, Chlorine,
  - Adds Essential Electrolytes Chloramines and Heavy Metals
  - Replaces Skin Slime and Stops Bleeding
  - Available by the Bottle or in Disposable Single Use Packets

U21-FW	G-Juice - Freshwater - 1 oz
U28-FW	G-Juice - Freshwater - 8 oz
U216-FW	G-Juice - Freshwater - 16 oz
U264-FW	G-Juice - Freshwater - 64 oz
U2.3FW-12PK	G-Juice - Freshwater - 1/3 oz packets, 12 pack
U216-SW	G-Juice - Salt Water - 16 oz
U264-SW	G-Juice - Salt Water - 64 oz

PLUMBING & DRAIN



Endorsed by  
*B.A.S.S. Elite Pro  
Gerald Swindle*

*"Keeps your fish  
alive in the most  
stressful tournament  
situations."*

**TOURNAMENT  
TESTED!**





# MR. CRAPPIE®

## BRAND

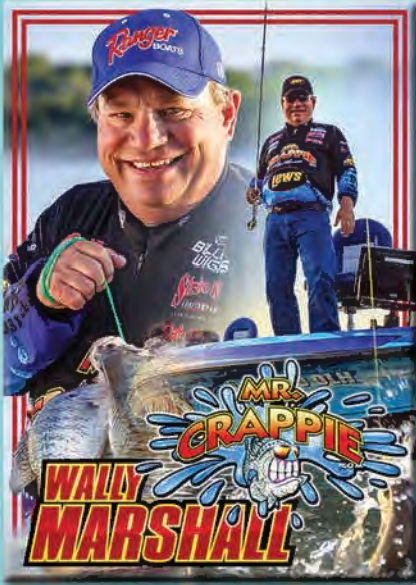

*Wally Marshall™*

“Without Mr. Crappie Care Products, You Can’t Win!”



### Livewell/Bait Tank Treatment Solution

- Specially Formulated for Crappie, Panfish, Minnows, Shiners and other Baitfish
- Keeps Your Bait Healthy and Alive
- Replaces Slime Coat and Helps Stop Bleeding
- Non-Toxic to Humans, Pets and Aquatic Life
- Removes Nitrites, Ammonia, Heavy Metals, Chloramines and Chlorine
- Adds Essential Electrolytes
- Available by the Bottle or in Disposable Single Use Packets

**NEW!!**

Part #	Description	Size
U2C1-FW	Mr.Crappie Crappie Care	1 oz
U2C8-FW	Mr.Crappie Crappie Care	8 oz
U2C64-FW	Mr.Crappie Crappie Care	64 oz
U2.3FW-12PK	Mr.Crappie Crappie Care	1/3 oz packets, 12 pack
U2C128-FW	Mr.Crappie Crappie Care	128 oz

**NEW!!** Designed by Mr. Crappie, Wally Marshall, to be the Ultimate Crappie Fishing Light

Wally Marshall says, “The Mr. Crappie Bait Blaster will have you catching crappie at night just like a pro! Mr. Crappie Bait Blaster is great for night-time crappie fishing and is awesome under docks. The Mr. Crappie Bait Blaster will draw millions of baitfish and crappie within minutes.”

### Mr. Crappie® Bait Blaster Underwater Light

- 18' Power Cable, Weighted to Maintain the Desired Depth Range
- Green LED Lights for Maximum Fish Attraction
- 360 Degree Light Output
- 180 LED Design

LED-34143 Mr. Crappie Bait Blaster Underwater Light





Improved Pump Design



PAS-1

## Pro-Air System – Livewell Aeration

- Provides Long Lasting Oxygen Rich Air
- Easy Mount for Fixed or Portable Tanks
- Dual Outlets Can Aerate Two Livewells at Once
- 12 Volt DC Pump is Potted & Waterproof
- Fine Mesh Screen or Air Stones
- Pump Capacity – Approx. 30 Gals.
- Draws Only 1/4 AMP

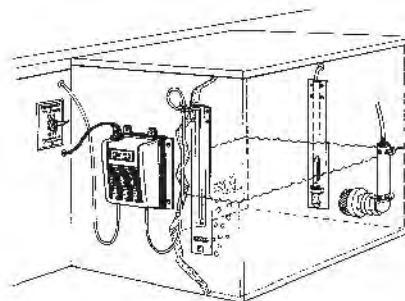

Part #	Description
PAS-1	Complete Kit – w/Air Stones
PAS-2	PAS-1 – No Switch
PAP-1	Pump Only
T-1	System Tubing – 500' Roll – 1/8"

PLUMBING & DRAIN



MAV-2KT

## MAX-AIR™ Livewell Venturi

- Most Efficient Aeration System Available
- Injects Air Low Into Livewell
- Fits 3/4" Hose

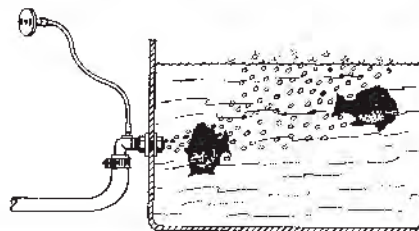

Part #	Description
MAV-2	MAX-AIR™ Venturi Fitting Only
MAV-2K	MAX-AIR™ Venturi Kit With Face Plate
MAV-2KT	MAX-AIR™ Venturi With Face Plate and 6' Tubing
MAV-FACEPLATE	Replacement Faceplate

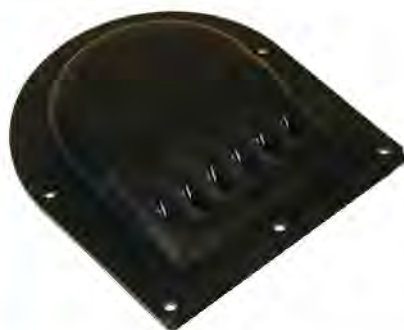

## Water Scoop

- Provides Fresh Water to Livewells While Underway
- Pressure Relief Holes Prevent Overpowering Pumps
- Can Be Used With Standard Aerator Pump

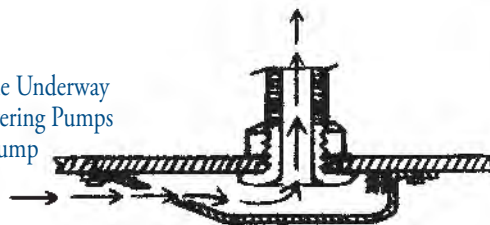

Part #	Description
WS-1	Water Scoop



## Automatic Aerator Control

- Turns Pumps On & Off Automatically
- Solid State Aerator Timer – Fully Adjustable
- 10 Amp Fully Waterproof Circuitry
- Handles High Capacity Pump Current Draw
- Requires 3" Round or 2-1/2" Square Hole
- Auto Spray (On) Time – 45 seconds
- Auto Delay (Off) Time – 45 seconds (min) – 5-1/2 min (max)

Part #	Description
AAC-1-DP	Automatic Aerator Control



# EZ-Pumps™

- UV Stable and Rust Resistant
- 3 Sizes Fits Most Installations
- Easy Installation - No Drilling or Running Hoses
- Screen and Pick-up All in One
- Gives the Tournament Angler an Edge Over the Competition
- Upgrade Your Present System Inexpensively
- Keep Fish and Bait Alive Longer
- Active Bait Gets You More Strikes
- Prevents Livewell System Air Lock
- Hassle Free Livewell Operation
- Extends Battery Life
- Fish in Stealth Mode



Part #	Description	Length (A)	Intake (B)	Size	Color
EZ-BLK-1	EZ Pump	4-3/4"	1" to 3-1/2"	Long	Black
EZ-WHT-1	EZ Pump	4-3/4"	1" to 3-1/2"	Long	White
EZ-SND-1	EZ Pump	4-3/4"	1" to 3-1/2"	Long	Sand
EZ-BLK-2	EZ Pump	3-3/8"	1" to 2-1/2"	Medium	Black
EZ-WHT-2	EZ Pump	3-3/8"	1" to 2-1/2"	Medium	White

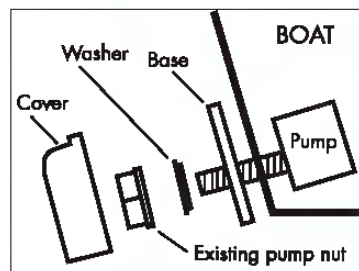
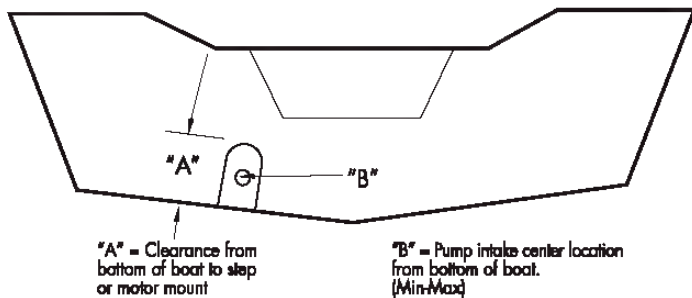

## Bait Tank Plumbing Kit

- Complete Kit for Plumbing Fixed or Portable Tanks
- Detailed Installation Instructions Included
- Kit Contains:
  - ODT-190 90° Overflow Drain Tube
  - TH-1202 1-1/8" Thru-Hull Drain Fitting
  - AHV-2 Aerator Spray Head w/Shut-off Valve
  - DAH-90 Directional Aerator Head for Current
  - TEE-3/4 Tee Fitting to Connect Both Heads to Pump

Part #	Description
BWK-2	Complete Baitwell Kit





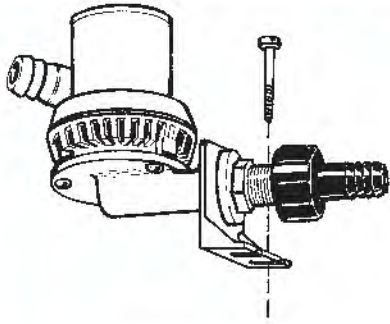

## Aerator Pump Bracket

- Molded Aerator Pump Support
- 1-1/8" Pump Mounting Hole

Part #	Description
PB-90	Right Angle Bracket



WDV-1

## Wash Down Fittings

- Injection Molded – Rust Proof
- Standard Garden Hose Threads
- Protective Cap w/ Retainer
- Flange is 2-1/4" dia. – Fits 1-1/4" Hole
- Fits 3/4" Hose



\*See page 86 for Hoses and Wash Down Stations



WD-1CP-DP

Part #	Description	Fits	Color
WDV-1	Wash Down Fitting	Straight with Shut-off Valve	Black
WDV-1CP	Wash Down Fitting	Straight with Shut-off Valve	Chrome
WDV-90	Wash Down Fitting	90 Degree with Shut-off Valve	Black
WD-1	Wash Down Fitting	Straight without Shut-off Valve	Black
WD-1CP-DP	Wash Down Fitting	Straight without Shut-off Valve	Chrome
AHVWD-90	Washdown Fitting/Aerator Spray Head*		Black
AHVWD-92	Washdown Fitting/Aerator Spray Head*		White

\*See below for details.



AHVWD-90



AHVWD-92



## Aerator Spray Head/ Wash Down Combos

- Single Fitting Handles Both Jobs
- Positive Action Shut-Off Valve
- Multi-Directional Spray Head



Part #	Description
AHVWD-90	Aerator Spray Head/Wash Down Fitting - Black
AHVWD-92	Aerator Spray Head/Wash Down Fitting - White

## Brite Plate™ Chrome Plated Fittings

- Look of Stainless – Price of Plastic
- Strong Plating Process Strengthens Parts
- Five Step Metal Bonding Process
- Won't Flake, Chip or Easily Scratch
- For Above Waterline Use



Straight	90 Degree	Extended Length	Description	Hose Size
TH-750CP	TH-7590CP	TH-750XLCP	Thru-Hull	3/4"
TH-1200CP	TH-1290CP	TH-1200XLCP	Thru-Hull	1-1/8"
	TH-1890CP		Thru-Hull Short	1-1/8"
TH-1500CP	TH-1590CP	TH-1500XLCP	Thru-Hull	1-1/2"
RFTH-2BCP			Scupper Thru Hull	1-1/2"
RF-1CP			Rigging Flange	

See page 31 for dimensions. Note: Recommend use of silicone sealant or neoprene gaskets only — see page 32.



## Directional Livewell Fill Fitting

- Protects Delicate Bait
- Provides Directional Current
- 90 Degree Design
- Allows Full Flow from Pump

Part #	Description
TH-DFR-1292	Livewell Directional Fill Fitting - 1-1/8" Barb - White



## Directional Flow Aerator Heads

- Creates Circular Current
- Keeps Baitfish Alive
- Max Wall Thickness – 5/8"
- Fits 3/4" Hose

Part #	Description	Hose Dia.
DAH-90	Directional Flow Head, 90 Degrees	3/4"
DAH-45	Directional Flow Head, 45 Degrees	3/4"
DAHI-118	Adjustable Flow Head	–
DAHIK-118	Adjustable Flow Head with Fitting	1-1/8"
DAHIK-750-DP	Adjustable Flow Head with Fitting	3/4"
APD-190FT	Fitting for DAHI-118	3/4"
TH-1890T	Fitting for DAHI-118	1-1/8"







## Aerator Spray Heads



AH-1



AH-90



AHV-1



AHV-90



AHV-92



AHVWD-90

Part #	Description	Shut-off	Barb	Hole Size	Thread Length
AH-1	Fixed Flange - Black	No	3/4	1-1/16	3/8
AH-90	Double Nut - Black	No	3/4	1-1/16	5/8
AH-92	Fixed Flange - White	No	3/4	1-1/16	5/8
AHV-1	Fixed Flange - Black	Yes	3/4	1-1/16	3/8
AHV-90	Screw On Valve - Black	Yes	3/4	1-1/16	3/4
AHV-92	Fixed Flange - White	Yes	3/4	1-1/16	5/8
AHV-1890	Screw-On Valve - 90°	Yes	1-1/8	1-1/4	3/4
AHVWD-90	Spray Head/Wash Down	Yes	3/4"	1-1/16"	3/4"
AHVWD-92	Spray Head/Wash Down	Yes	3/4"	1-1/16"	3/4"

## Cockpit Drains

- Tapered or Flat Head Designs
- Complete Drainage for Cockpit Areas
- Flush Fit Drop-in Screens
- 90° & White Only

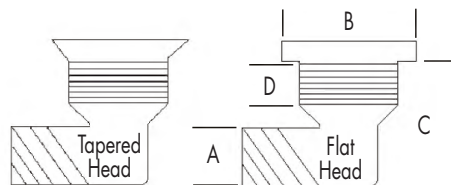

Part #	A	B	C	D	Head	Style
TH-1992	1-1/2"	2-3/8"	3"	1"	Tapered	Open Drain
TH-1992S	1-1/2"	2-3/8"	3"	1"	Tapered	Removable Screen
TH-1992BHS	1-1/2"	2-3/8"	3"	1"	Flat	Big Head w/ Screen
TH-1992R	1-1/2"	2-3/8"	3"	1"	Tapered	Debris Bar Insert
TH-1992FH	1-1/2"	2-3/8"	3"	1"	Flat	Open Drain
TH-1992FHS	1-1/2"	2-3/8"	3"	1"	Flat	Removable Screen
TH-1992FHR	1-1/2"	2-3/8"	3"	1"	Flat	Debris Bar Insert

## Deck Drain Thru-Hulls With Grille

- Prevents Objects From Passing Thru Drain
- Excellent Shower Drain
- Fits 1-1/2" Hose

TH-1502G-B	Straight, White
TH-1592G-B	90°, White
FG-150	Grill for 1-1/2" Thru Hull





## Flow-Max™ Ball Scuppers

- Replaces Worn Out Flapper Scuppers
- 70% More Drainage Than Competitive Models
- New Twist-Off Feature for Clearing Debris
- Retrofits All Hole Patterns
- Stainless Steel Lock Screw for Safety
- Seal Slotted to Fit Over 1-1/4" Motorwell Tube



Part #	Description
FMS-1-0	Flow-Max™ Ball Scupper - Clear 3" dia. x 2-1/2" h

## Cockpit Scupper Drains

- Check Ball Inside Prevents Water Backup
- Molded From High Strength Material – UV Stabilized
- Top Screen Removable for Cleaning

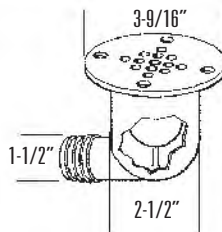

Part #	Description	Color	Hose Dia.
CSD-92	90° Outlet	White	1-1/2"
CSD-92W0	90° Outlet without Check Ball	White	1-1/2"
CSD-90	90° Outlet	Oyster	1-1/2"

## Inline Scupper

- Three Sizes Available
- Prevents Backwash
- Chemical Resistant Materials
- Thermo-Plastic Flapper



Part #	Hose Size	Description
ILS-750	3/4"	Double Barb Inline Scupper - Black
ILS-1200	1-1/8"	Double Barb Inline Scupper - Black
ILS-1500	1-1/2"	Double Barb Inline Scupper - Black

## Large Rectangular Scuppers

- Quickly Drains Decks
- For Decks Above Waterline
- Maximum Drainage for Larger Boats
- Easily Clears Debris
- Fits 2" x 5-1/2" Opening



Part #	Description
LRS-2-DP	Rectangular Scupper - White

## Duckbill Scuppers

- Tough Thermoplastic Flapper
- Easy to Install Over Drain Tubes
- Seals Tight Under Water Pressure
- 1-13/16" ID and 2-3/4" OD

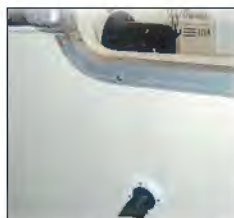

Part #	Description
DBS-2B	Duckbill Scupper - Blk/Wht

PLUMBING & DRAIN





## Flush Mount Scupper Adapters

- Mounts Over 1" to 1-1/4" Drain Tubes
- Grooved Inside to Fit Over Drain Flange

Part #	Description
SA-1	Flush Mount Scupper AdaptersBlack/Black Flapper
SA-2	Flush Mount Scupper AdaptersWhite/White Flapper
SA-2B	Flush Mount Scupper AdaptersWhite/Black Flapper
SA-3	Flush Mount Scupper AdaptersSand/Sand Flapper



## Flapper Scupper Repair Kit

- Repairs Most Scuppers
- Kit Contains: 2 each 1-5/8" – 1-7/8" & 2-1/4" OD Flappers Keepers and Stainless Fasteners



Part #	Description	Color
FSRK-1-DP	Flapper Scupper Repair Kit	Black



## Recessed Flapper Scupper Drains

- Thermo-Plastic Flapper Won't Curl
- Flapper Impervious to Sun or Chemicals

## Push-Together Scuppers

- Mating Rib Design Snaps Together
- Outside Flange Diameter – 2-15/16"
- Installs in 1-7/8" Hole

Part #	Description	Hull Thickness	Color
RFS-1	Push-Together Scupper	1-1/2 to 3-5/8"	Black
RFS-2	Push-Together Scupper	1-1/2 to 3-5/8"	White



## Recessed Threaded Thru-Hull Scuppers

- Fits Hulls Up to 3-1/2" Thick (XS Models Fit 1-3/8" Hulls)
- Barbed to Fit 1-1/2" or 2" Hose

Part #	Description
RFTH-2B	Fits 1-1/2" Hose; White/Black Flapper
RFTH-2BCP	Fits 1-1/2" Hose; Chrome/Black Flapper
RFTH-1XS	Fits 1-1/2" Hose; Black Short Thread
RFTH-2XS	Fits 1-1/2" Hose; White Short Thread



## Flex Flange Thru-Hull Drain

- Unique Flexible Flange
- Allows Near Total Drainage
- 1-1/2" Hose Barb
- Easily Connects to Scuppers

Part #	Description
TH-1502FF	Flex Flange Drain - 1-1/2"

## Splash Well Drains

- Molded High Strength Material
- Flexible to Prevent Breakage
- Push Together for Secure Fit
- Brite Plate Chrome Models



Black #	White #	Chrome #	CMax Thickness	Hole
SWD-1	SWD-1W		1-7/8" to 3-1/8"	1"
SWD-3	SWD-3W	SWD-3WCP	2-3/4" to 4-1/2"	1-1/4"
	SWD-4W	SWD-4WCP	1/2" to 3"	1-1/4"
SWD-5			2-3/4" to 12"	1-1/4"



## All Purpose Drains/ Hatch Drains

- Low Profile Flat or Concave Head for Complete Drainage
- Requires 1-3/8" Hole



Black #	White #	Description	"A"	"B"	"C"	"D"
APD-1	APD-2	Straight - Concave	1-3/4"	3/4"	3/4"	2"
APD-1F		Straight - Flat	1-3/4"	3/4"	3/4"	2"
APD-190	APD-290	90 Degree - Concave	1-3/4"	1/2"	3/4"	2"
APD-190F	APD-290F	90 Degree - Flat	1-7/8"	7/8"	3/4"	2-1/4"
APD-118	-	Straight - Concave	1-3/4"	3/4"	1-1/8"	2"
PP-118		Plug for All Parts Above				

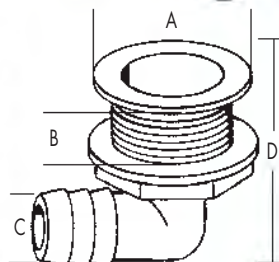

## Impact & Push-In Drains

- Low Profile Head for Complete Drainage
- Easily Push Into Place

Part #	Description	Dia.	Length	Color
PD-1	Push-In Drain	3/8"	1-1/16"	Black
PD-2	Push-In Drain	3/8"	1-1/16"	White
IPD-580	Impact Drain	5/8"	1/2"	Black
IPD-582	Impact Drain	5/8"	1/2"	White
IPD-1000	Impact Drain	1"	3/4"	Black
IPD-1000-5	Impact Drain	1"	5-1/8"	Black
IPD-1002	Impact Drain	1"	3/4"	White
DBAS-1W	Push-In Drain	3/8"	1-1/2"	White
DBBS-1W	Push-In Drain	5/8"	1-1/2"	White
DBBS-1G	Push-In Drain	5/8"	1-1/2"	Gray



Push-In Drains



Impact Drains

## Seat Pedestal Drains

- Marine Grade Vinyl - Slide On
- Requires 1/4" Tubing

Part #	Description	Fits
SPD-1	Seat Pedestal Drain	Fits 1-1/4" Pedestal

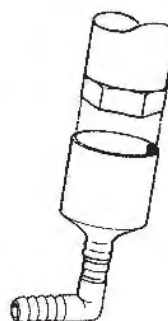





## Floor Drain – Lid Pulls

- Combination Drain with Lid Pull
- Perfect for Ski Lockers & Hatches
- 5-1/4" Dia. – Fits 3-3/4" Hole

Part #	Description
FDP-4WS	Floor Drain/Pull, Off-white, Sand



## Floor Drains

- Drain with Flange for Secure Fit

Black	White	OD Dia.	Cut Out
FD-2	FD-2W	4-1/8"	2-1/4"
FD-4	FD-4W	5-1/4"	3-3/4"

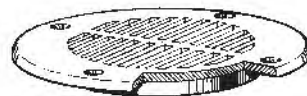

## Louvered Vent Covers

- Deflects Rain & Eliminates "See-Thru"

Black	OD Dia.	Cut Out
LV-1	5-1/4"	3-3/4"



## Overflow Drains With Filter

- Filter Prevents Baitfish or Debris from Passing Thru
- Thru-Hull Style Overflow – Fits 1-1/2" Hose

TH-1502F	Overflow Drain	Straight, White
TH-1592F	Overflow Drain	90 Degree, White
FF-150	Overflow Drain	Filter Only

PP-150



## Push-In Plug for Drains

- Stops Water in Livewell or Baitwell Drains
- Marine Grade Molded Vinyl
- Double Rings for Positive Seal

PP-150	Push-In Plug for 1-1/2" Thru-Hull Drains
PP-118	Push-In Plug for 1-1/8" Thru-Hull and All Purpose Drains
PP-125	Push-In Plug for 1-1/4" Thru-Hull Drains



PP-118



DP-1

## Drain Plugs

- Screw-In Plug – Stays With Boat
- Tough Nylon Material – "O" Ring Seal
- Flange 1-1/2" x 2" – Fits 1" Hole

DP-1	Drain Plug	Black
DP-2	Drain Plug	White
DP-1FS	Drain Plug – Flexible Stem	Black



DP-1FS



## Garboard Drain Plug & Base

- Chrome Brass
- Salt Water & UV Resistant
- 9/16" Plug
- Fits 1" Hole

Part #	Description
GDP-ICB	Garboard Drain Plug & Base

## Overflow Drain Tubes

### Push In Tubes

- Fits Securely Into Drains (T-H Marine)
- Flexible Marine Vinyl Seals

ODT-1	Fits All T-H Marine 1-1/8" Thru Hulls - Straight - 12"L
ODT-190	Fits All T-H Marine 1-1/8" Thru Hulls - 90° - 12"L
ODTS-1	Filter Screen for ODT-1 & ODT-190
ODT-2	Fits All T-H Marine 1-1/2" Thru Hulls - Straight - 18"L with screen
ODT-290	Fits All T-H Marine 1-1/2" Thru Hulls - 90° - 18"L with screen
ODTS-2	Filter Screen for ODT-2 & ODT-290

*NOTE: Any tube above can be cut to custom lengths. Specify length by adding to part number (inches) (ie: "ODT-1-8" = eight inches)*



### Screw In Tubes

- Threaded Seal - Cannot Be Knocked Out
- Unscrew Half Way to Expose Drain Holes

ODT-1-12TW	Fits 1-1/8" Threaded Drain - Straight - 12"L
ODT-1-12GSTW	Fits 1-1/8" Threaded Drain - With Top Screen Glued - 12"L
ODT-2T	Fits 1-1/2" Threaded Drain - w/Screen - Straight - 18"L

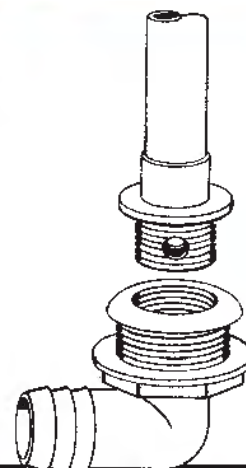

### Threaded Drains

- Threaded to Fit Screw-In Tubes Above

TH-1200T	Thru-Hull Drain - 1-1/8" Barb - Straight
TH-1200XLT	Thru-Hull Drain - 1-1/8" Barb - Xtra Long
TH-1290T	Thru-Hull Drain - 1-1/8" Barb - 90°
TH-1890T	Thru-Hull Drain - 1-1/8" Barb - Short 90°
TH-1502T	Thru-Hull Drain - 1-1/2" Barb - Straight White
TH-1592T	Thru-Hull Drain - 1-1/2" Barb - 90° White

### Livewell Overflow Tube/Utility Storage Clips

- Two Sizes to Fit 7/8" or 1-1/2" Tubes
- Mounts Anywhere - Holds Securely
- Holds Nav Light Poles, Overflow Tubes, Etc.

Part #	Description	Fits
ULC-1	Utility Storage Clips	ODT-1 or any 7/8" Tube
UC-1	Utility Storage Clips	ODT-2 or any 1-1/2" Tube
RUSC-1	Rubber Utility Storage Clip	ODT-1 or any 7/8" Tube



### Aerator Filter Domes

- Protects Pumps From Debris
- Twist-Off to Clean
- Mounts Behind Standard Thru-Hulls

Part #	Description	Hole I.D.	Application
AFD-2	Aerator Filter Dome	1"	Fits 3/4" Thru-Hull or Pump
AFD-118	Aerator Filter Dome	1-5/8"	Fits Top of 1-1/2" Thru-Hull
AFD-118P	Aerator Filter Dome	1-3/8"	Fits 1-1/8" Thru-Hull







## Aerator Filter

- Protects Pumps From Debris
- Screws On Over Pump Intake Fitting
- Fits Over 3/4" or 1-1/8" Fittings
- Available with Snap-On Mount

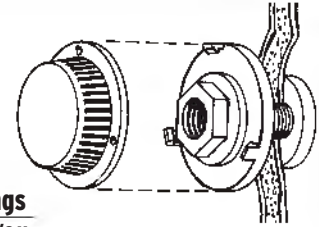

Part #	Description	Fits Fittings
AF-1	Aerator Filter	3/4" or 1-1/8"
AFM-1	Aerator Filter With Mount	3/4"



## Bait Well Filter w/ Mount

- Fits Over Bait Well Drains
- Prevents Ingestion of Bait Fish
- Mounts Behind Drain Fitting

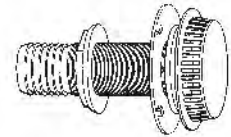

Part #	Description	Fits
BWF-1	Bait Well Filter	Fits 1-1/2" Thru-Hull

Thru-Hull Not Included



## Stainless Steel Wire Mesh Strainers

- Protects Pumps From Debris or Bait Fish
- Formed Wire Mesh – Molded PVC Threaded Base

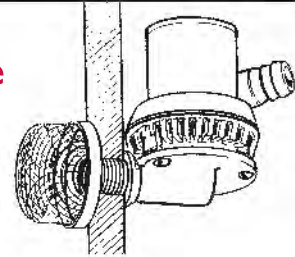

Part #	Fits	Threads
AS-1	Aerator Pump Intake	3/4" - 14
AS-2	TH-1, 1XL, 90, 92 Thru-Hulls	1" - 8



## Miniature Stainless Aerator Screens

- Pushes Snug Into Thru-Hull Fittings
- Easily Removed for Cleaning
- For Recirc Systems or Drains

Part #	Fits
ASM-5	Fits 1-1/8" Thru-Hull Fittings & All APD's

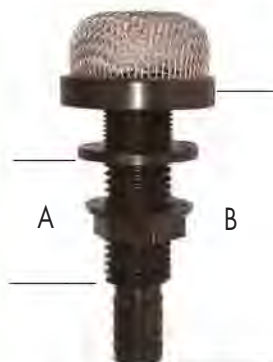

## Thru-Hull Strainer Mounts

- Threaded to Fit AS-1 Stainless Screen
- Flange Allows Flush Fit – No Outside Nut
- Fits 3/4" Hose

Part #	A	B	Description
THSM-1	1-3/4"	4"	Fitting Mount
THSM-1XL	3"	4-1/2"	Long Fitting
THSM-1KIT	1-3/4"	4"	Mount & Screen
AS-1	-	-	Screen Only



## CeaCap™ Bulkhead Pass-Thru Fitting

- Watertight Seal for Cables, Tubing or Wires
- Self-Attaching – No Hardware Needed
- Turn Down Washer Included

Part #	Description	Color
TH-CC-1	1/4" slot, 3/4" hole, 1-1/4" flange	Black
TH-CC-2	1/4" slot, 3/4" hole, 1-1/4" flange	White
TH-CCL-1	9/32" slot, 1" hole, 1-1/2" flange	Black
TH-CCL-2	9/32" slot, 1" hole, 1-1/2" flange	White



## Overflow Fittings with Filters

- Prevents Drain Clogs
- Twist-Off to Clean
- Fits 1-1/2" ID Hose

Part #	Description	Size
TH-1500AFD	Overflow Fitting	Straight
TH-1500XSFAFD	Overflow Fitting	Straight Short
TH-1590AFD	Overflow Fitting	90 Degree
PP-150	Push Plug for Overflow	

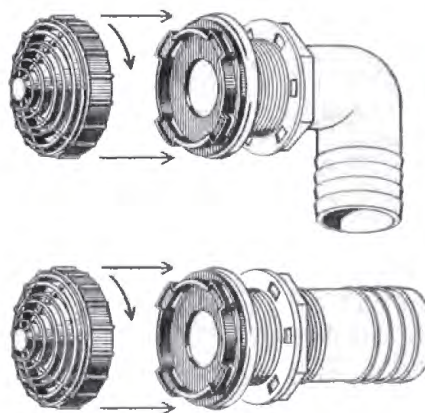

## Thru-Hull Washer/ Gaskets

- Water Tight Seal for Thru-Hulls
- Eliminates Need for Messy Sealant
- Gaskets Compress Flat/Almost Invisible

Part #	Type	Material	Fitting Size
THW-750	Gasket	Closed Cell Neoprene Foam	3/4"
THW-1200	Gasket	Closed Cell Neoprene Foam	1-1/8"
THW-1500	Gasket	Closed Cell Neoprene Foam	1-1/2"



## Seacock Remote Operation Arm

- Operate Seacock from Deck
- Stainless Steel Arm
- Call for Custom Lengths, Brackets and Minimums

Part #	Description
SEACOCK-15.5	Seacock Remote Operation Arm - 15.5" Length
SEACOCK-18.5	Seacock Remote Operation Arm - 18.5" Length
SEACOCK-24	Seacock Remote Operation Arm - 24" Length
SEACOCK-36	Seacock Remote Operation Arm - 36" Length
SEACOCK-40	Seacock Remote Operation Arm - 40" Length
SCB-527	Seacock Arm Mounting Bracket - 4" Length

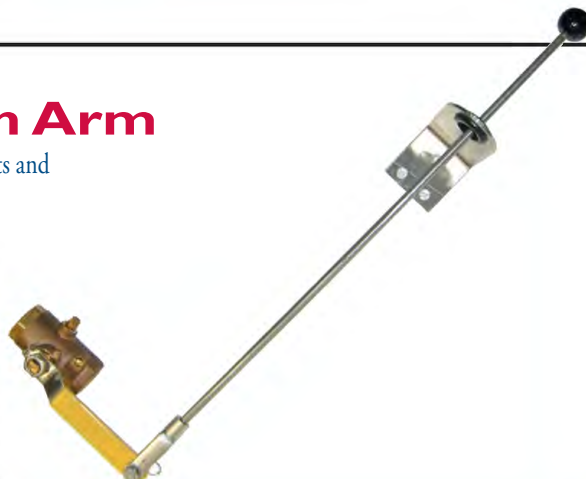





## Thru-Hull Fittings

- High Quality UV and Chemical Resistant Virgin Polypro
- Sized to Fit All Marine Hose
- 90° Features Finished Head & Pass-Around Nut

### STRAIGHT FITTINGS

Thru-Hull Dimensions Chart - Straight (inches)

Part # Black	Part # White	A	B	C	D	E
TH-500	TH-502	1-3/8	3-1/16	1-3/4	1/2	1
TH-650	TH-652	1-3/8	3-3/8	1-3/4	5/8	1
TH-750	TH-752	1-3/8	3-1/16	1-3/4	3/4	1
TH-1000	TH-1002	1-7/8	3-1/2	1-5/8	1	1-3/8
TH-1200	TH-1202	1-7/8	3-1/2	1-3/4	1-1/8	1-3/8
TH-1500XS	TH-1502XS	2-7/8	2-3/4	1	1-1/2	2
TH-750XL	TH-752XL	1-3/8	4-1/2	3	3/4	1
TH-1200XL	TH-1202XL	1-7/8	5-3/8	3-3/8	1-1/8	1-3/8
TH-1500XL	TH-1502XL	2-7/8	5-3/8	3-1/4	1-1/2	2

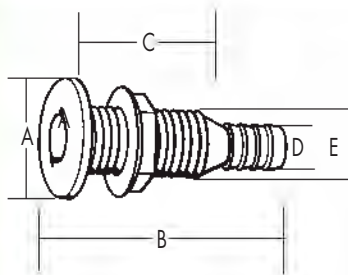

### 90 DEGREE FITTINGS

Thru-Hull Dimensions Chart - 90 Degree (inches)

Part # Black	Part # White	A	B	C	D	E
TH-7590	TH-7592	1-3/8	2-1/2	1	3/4	1
TH-1290	TH-1292	1-7/8	3-1/2	1-1/8	1-1/8	1-3/8
TH-1890	TH-1892	1-7/8	2-1/4	3/4	1-1/8	1-3/8
TH-1590	TH-1592	2-7/8	4-1/4	1-5/8	1-1/2	2

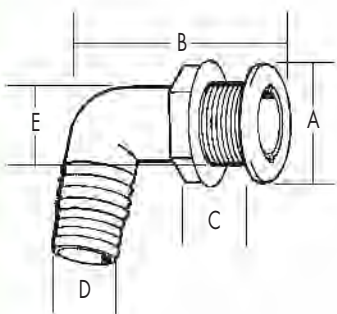

## Specialty Thru-Hull Fittings

- TH-7590S — Black
- TH-1290S — Black
- TH-1292S — White
- Spanner Head
- Low Clearance

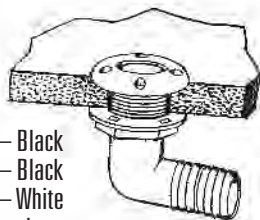

- TH-1 — Standard
- TH-1XL — Long
- Fixed Flange
- Outside Nut

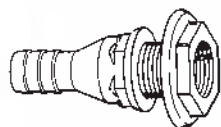

- TH-3S — Black
- Flat Head
- Total Drainage
- Requires No Sump

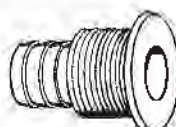

- TH-90 — Black
- TH-92 — White
- Double Nut
- 90 Degree

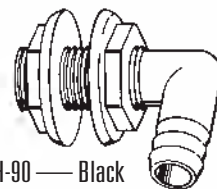

### SPECIALTY FITTINGS

Thru-Hull Dimensions Chart - Specialty Fittings (inches)

Part # Black	Part # White	A	B	C	D	E
TH-1	-	1-5/8	2-3/4	3/8	3/4	1
TH-1XL	-	1-5/8	3-1/8	1-1/4	3/4	1
TH-3S	-	1-1/2	2	1	3/4	1
TH-90	TH-92	1-5/8	2-5/8	7/8	3/4	1
TH-7590S	-	1-5/8	2-5/8	7/8	3/4	1
TH-1290S	TH-1292S	2-3/8	3-1/4	7/8	1-1/8	1-3/8
-	TH-1502S2	2-7/8	3	3/4	1-1/2	1-7/8
-	TH-1502S2N	2-7/8	3-3/4	3/4	1-1/2	1-7/8
APD-190F	APD-290F	1-7/8	2-3/8	3/4	3/4	1-3/8

- TH-1502S2 — White
- TH-1502S2N — Jam Nut
- Tight Clearance
- Two Piece Fitting
- With or w/o Jam Nut

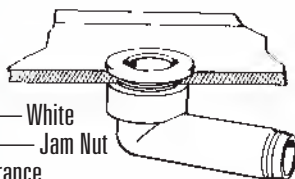

- APD-190F — Black
- APD-290F — White
- Flat Head
- Total Drainage
- Requires No Sump

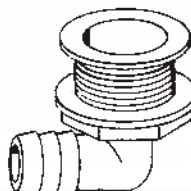



## Plumbing Fittings

FA-3/4	Female Adapter - Straight - Gray
	Hose I.D.: 3/4"
	Threads: Female Straight 3/4" - 14



FA-3/4

FA-90	Female Adapter - 90 Degree - White
	Hose I.D.: 3/4"
	Threads: Female Straight 3/4" - 14



FA-90

### Elbows

ELL - 3/4	90° Elbow, 3/4" Hose I.D.
ELL-118	90° Elbow, 1-1/8" Hose I.D.



ELL-3/4

### Tee-Reducing

#### Size - Black

TEE-150	Hose I.D.: 1-1/2" - 3/4" - 1-1/2"
TEE-250	Hose I.D.: 1-1/8" - 3/4" - 1-1/8"
TEE-350	Hose I.D.: 1-1/2" - 1-1/8" - 1-1/2"



TEE-150

### Tees

#### Size - Black

TEE-3/8	TEE, 3 way, 3/8" Hose I.D.
TEE-5/8	TEE, 3 way, 5/8" Hose I.D.
TEE-3/4	TEE, 3 way, 3/4" Hose I.D.
TEE-118	TEE, 3 way, 1-1/8" Hose I.D.
TEE-112	TEE, 3 way, 1-1/2" Hose I.D.

TEE-112



### Y-Fitting

#### Size - Black

Y-118	Y-Fitting, 3 Way, 1-1/8" Hose
Y-750	Y-Fitting, 3 Way, 3/4" Hose

Y-118







## Manifold Systems - Refer to Website for More Sizes and Models



### “T” Fittings

- Glass Filled Polymer
- Less Expensive than Brass
- Four Sizes for Multiple Flow Rates

MS-3TT34 “T” Fitting - 3 Way 3/4” FNPT

MS-3TT100 “T” Fitting - 3 Way 1” FNPT

MS-3TT112 “T” Fitting - 3 Way 1-1/2” FNPT



### Adapter Fittings

- Converts from Pipe Threads to Hose Barbs
- Tough Glass Filled Polymers

MS-3A100 Adapter Fitting - 1” MPT to 1” Barb

MS-3A10034 Adapter Fitting - 1” MPT to 3/4” Barb

MS-3A11434 Adapter Fitting - 1-1/4” MPT to 3/4” Barb

MS-3A112 Adapter Fitting - 1-1/2” MPT to 1-1/2” Barb



### Nipple Fittings

- Connects Sea Cocks to Manifolds
- Male National Pipe Threads on Each End
- 4 Sizes to Fit Most Systems

MS-3M100 Nipple Fitting - 1” MPT to 1” MPT

MS-3M114 Nipple Fitting - 1-1/4” MPT to 1-1/4” MPT



### Reducer Fittings

- Reduces from Male to Female National Pipe Threads
- Connects Pumps to Manifolds
- 3 Sizes Makes Most Connections

MS-3RB10034 Reducer Fitting - 1” MPT to 3/4” FPT

MS-3RB11234 Reducer Fitting - 1-1/2” MPT to 3/4” FPT



### 90 Degree Elbow Fittings

MS-3EL1234 Elbow Fitting - 1/2” MPT to 3/4” Hose Barb

MS-3EL34 Elbow Fitting - 3/4” MPT to 3/4” Hose Barb

MS-3EL100 Elbow Fitting - 1” MPT to 1” Hose Barb



## Custom Rod Organizers

- Starboard™ Custom Plates
- Oval Shaped Rod Tubes for Better Rod Eye Fit
- Heavy Walled PVC Tubes
- Custom OEM Designs, Sizes & Number of Tubes
- Vinyl Caps Available to Fit All Tubes
- Call for Details on Ordering



## Custom Rod Tubes

- Rod Tubes Available in Oval and Round Shapes
- Various Mounting Flanges Available
- Vinyl Caps Available to Fit All Tubes (Add -WCI to end of part # to have installed)

Part #	Description	Dia.	Hole Size	Max Length
TE0-2.50-1-"X"	Med Oval Rod Tube w/Black Flange	2.30"	2-1/2"	80"
TE0-2.50-2-"X"	Med Oval Rod Tube w/White Flange	2.30"	2-1/2"	80"
TE0-2.50-3-"X"	Med Oval Rod Tube w/Sand Flange	2.30"	2-1/2"	80"
TE0-3.00-1-"X"	Lg Oval Rod Tube w/Black Flange	3.00"	3"	80"
TE0-3.00-2-"X"	Lg Oval Rod Tube w/White Flange	3.00"	3"	80"
TE0-3.00-3-"X"	Lg Oval Rod Tube w/Sand Flange	3.00"	3"	80"
TE-1GT-"X"	Round 2.250" Dia. Tube w/Black Flange			
TE-1FWGT-"X"	Round 2.250" Dia. Tube w/White Flange			
TE-1SGT-"X"	Round 2.250" Dia. Tube w/Sand Flange			
PH-3FWGT-"X"	Round 2.60" Dia. Tube w/White Flange			
PH-3SGT-"X"	Round 2.60" Dia. Tube w/Sand Flange			

"X" = Length of Tube Desired in Inches

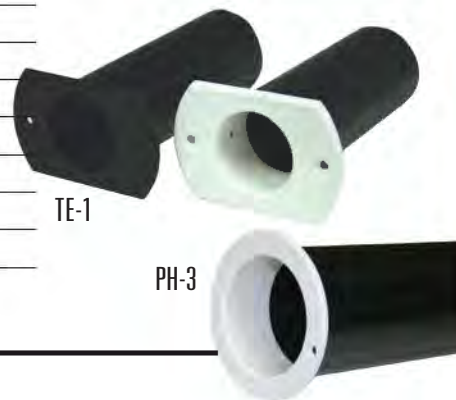

## Rod Tubes & Vinyl Caps

Part #	Description	Dia.	Hole Size	Max Length
GT-1.375-"X"	Sm Round Rod Tube w/Rolled Top	1.375"	1-3/8"	43"
GT-1.700-"X"	Med Round Rod Tube w/Rolled Top	1.70"	1-3/4"	60"
GT-2.250-"X"	Lg Round Rod Tube w/Rolled Top	2.25"	2-1/4"	80"
VCAP-1.375	Vinyl Cap - Fits 1.375" Tubes	1-3/8"	n/a	n/a
VCAP-1.687	Vinyl Cap - Fits 1.70" Tubes	1-11/16"	n/a	n/a
VCAP-2.125	Vinyl Cap - Fits 2.50" Tubes	2-1/8"	n/a	n/a

"X" = Length of Tube Desired in Inches



## Rod Storage Holders

- Mounts Horizontally or Vertically
- Foam Insert Holds Rods Securely
- Holds up to 6 Rods

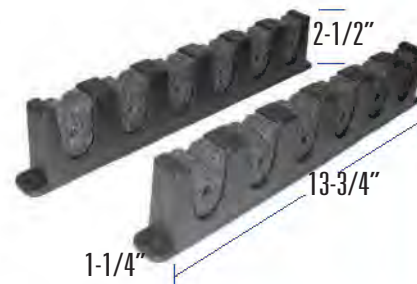
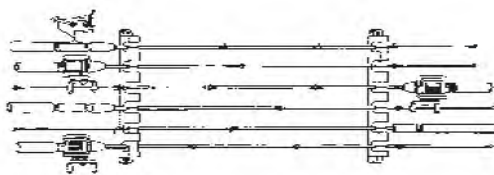

Part #	Description
FRH-1P-DP	Foam Rod Holder - Packaged Pair





## Rod Grommets

- Flexible Marine Vinyl
- Protects Rod Tips or Butts
- Also Great for Boat Hooks, Gaffs, etc.

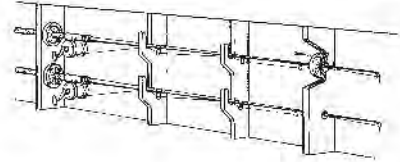

Part Numbers			Dimensions (inches)	
Black	White	Fish White	O.D.	Max Hole Size
UG-1	UG-1W	UG-1FW	3-3/8	2-3/8
UG-2	UG-2W	UG-2FW	2-3/4	1-3/4
UG-3	UG-3W	UG-3FW	4	3



## Rod Tube Ends

- Tapered Inside to Protect Rod Tips
- Opening is 1-7/8" ID – Requires 2" Hole

- Fits Inside 2" PVC Pipe

Part #	Description	Color	Fits
TE-1	Tube End	Black	GT-2.250
TE-1W	Tube End	Oyster	GT-2.250
TE-1FW	Tube End	Fish White	GT-2.250
TE-1S	Tube End	Sand	GT-2.250
PH-30	Tube End for 2-5/8" pvc	Oyster	GT-2.60
TE0-2.50	Oval Tube Flange		See pg. 35 for details



## Rod Tamer™ Rod Straps

- Holds Rods Securely – Can't Snag Hooks
- Polyurethane Cord – UV & Chemical Resistant
- Non-Corrosive Molded Ends and Hooks

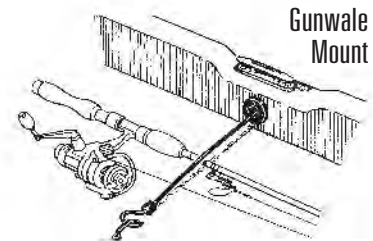

### Gunwale Mount

- Retracts Into Gunwale When Unused
- Requires 3/4" Hole

### Deck Mount

- Strap End Mounts Directly to Deck

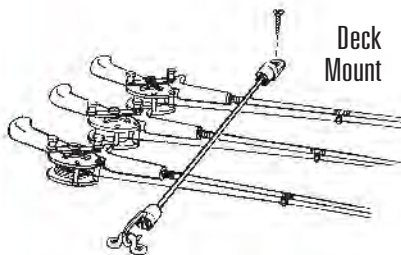

RHDN-1	Rod Tamer™	12" Gunwale Mount, Small Hook
RHDN-2	Rod Tamer™	18" Gunwale Mount, Small Hook
RHD-1	Rod Tamer™	12" Gunwale Mount, Holds Up to 3 Rods
RHD-2	Rod Tamer™	18" Gunwale Mount, Holds Up to 6 Rods
RT-14	Rod Tamer™	14" Deck Mount, Holds Up to 4 Rods
RT-18	Rod Tamer™	18" Deck Mount, Holds Up to 7 Rods

NOTE:  
Custom  
Lengths  
Available  
in RT  
Models

Note: Available with Stainless Steel Eye Straps — Call for Information.



## Rod Holder Drain Caps

- Molded Marine Vinyl Drain Cap
- Accepts 3/8" Tubing (Not Included)

Part #	Description	Fits
RHBD-1	Rod Holder Drain Cap	All T-H Rod Holders
RHBD-2SS	Rod Holder Drain Cap	Most Stainless Steel Rod Holders
RHBD-2SST	Rod Holder Drain Cap	Most Stainless Steel Rod Holders, w/ Tee





## Pedestal Base Plug

- Keep Water Out of Your Pedestal Base
- Seals Pedestal Base When Seat is Out

- Fits 1.77" Bases
- Slide Pin for Easy Removal
- Molded Material Won't Rust or Corrode



Part #	Description
PBP-1	Pedestal Base Plug

## Molded Rod Racks

- Rugged One-Piece Poly
- Holds Rods Securely
- UV Stabilized to Resist Fading
- Knife, Pliers & Lure Slots



Part #	Description	Color	Holds
RHRM-2B	Molded Rod Racks	Black	2 Rods
RHRM-2W	Molded Rod Racks	White	2 Rods
RHRM-3B	Molded Rod Racks	Black	3 Rods
RHRM-3W	Molded Rod Racks	White	3 Rods



## Rod Racks

- UV Stabilized Polypro Tubes with Reel Slots
- High Density Polyethylene Racks
- Knife and Pliers Holders on All Racks
- Stainless Steel Mounting Hardware

Rack Color	Tube Color	Three Rack Part #
Black	Black	RHRB-3B
White	White	RHRW-3W
Fish White	Fish White	RHRFW-3FW



## Rod Holders

- Durable UV Stabilized Tubes
- One-Piece Design for Easy Installation
- Rod Index in Bottom of All Models
- Fits 1-7/8" Hole
- "Rocket Launcher" Style with Reel Slot
- Standoffs Allow Individual Mounting
- Available Without Standoffs for Rack Mounts

- New Oval Head Shape
- Molded for UV Resistance
- Textured for Appearance
- Fits 2" Hole



RHSF-3



RH-1



RH-2FW



RH-4



Description	Length	Black	White	Off-White
Angled 30°	8-3/4"	RH-1	RH-1FW	
Flat Top	8-3/4"	RH-2	RH-2FW	RH-2W
Removable Standoffs	11-7/8"	RHS-3B	RHS-3FW	RHS-3W
No Standoffs	11-7/8"		RH-3FW	RH-3W
Fixed Standoffs	11-7/8"	RHSF-3B	RHSF-3FW	RHSF-3W
Angled Top - Oval Head	8-1/8"	RH-4		
Angled Top - Oval Head - Long	9-7/8"	RH-5	RH-5FW	





# G-Force Eliminator™ Prop Nut

**NEW!!**

The ELIMINATOR™ Prop Nut is built to make your trolling motor perform better, longer and quieter. Designed to lessen prop noise and vibration, The ELIMINATOR™ Prop Nut stabilizes the prop by providing a larger contact point.

In addition, it acts as a heat sink and has built-in cooling ports that reduce the operating temperature for longer battery and trolling motor life. Made to fit most Minn Kota and Motorguide trolling motors. Comes in an assortment of colors to provide a sleek, matching aesthetic. Make sure that you're getting the most out of your trolling motor with the the ELIMINATOR™ Prop Nut.



- Machined from 6061 Billet Aluminum
- O-ring Dampens Noise/ Vibration and Secures Nut
- Wider Contact Area for a More Stable Prop
- Cooling Ports Aid in Heat Dissipation
- Anodized Protected
- No Tools Needed

- Available in Popular Colors
- Visually Appealing
- Designed and Made in the U.S.A.
- Patent Pending

Brand	Black	Blue	Clear Silver	Red
MOTORGUIDE	GFEL-MG-BK-DP	GFEL-MG-BU-DP	GFEL-MG-C-DP	GFEL-MG-R-DP
MINN KOTA 80+	GFEL-MK-BK-DP	GFEL-MK-BU-DP	GFEL-MK-C-DP	GFEL-MK-R-DP
MINN KOTA 75-	GFEL-MKS-BK-DP	GFEL-MKS-BU-DP	GFEL-MKS-C-DP	GFEL-MKS-R-DP





## G-Force Equalizer™

**NEW!!**

### Trolling Motor Lift Assist

- Reduce Lift Weight by 50% Plus
- For Motorguide Trolling Motors
- Available in Black, Red, and Blue
- Easy Installation
- Marine-Grade Stainless Steel Hardware
- Sold in a Pair



Part #	Description	Fits	Color
GFEQ-MG-BK-DP	G-Force Equalizer™ Trolling Motor Lift Assist	Motorguide	Black
GFEQ-MG-BU-DP	G-Force Equalizer™ Trolling Motor Lift Assist	Motorguide	Blue
GFEQ-MG-R-DP	G-Force Equalizer™ Trolling Motor Lift Assist	Motorguide	Red

## G-Force Silencer™

### Trolling Motor Vibration Pads

- Extends Life of Trolling Motor
- Reduces Noise and Vibration
- Eliminates Metal-to-Metal Contact
- Prevents Harsh Clanking when Stowing Trolling Motor
- Available in Red and Black
- Package will Contain Product for Motorguide and Minn Kota



**PLACEMENT CHART**

MOTORGUIDE	MINN KOTA FORTEX	MINN KOTA MAXXUM/EDGE

Part #	Description	Color
GFES-RED-DP	G-Force Equalizer™ Trolling Motor Vibration Pads	Red
GFES-BLK-DP	G-Force Equalizer™ Trolling Motor Vibration Pads	Black

## Wireless Trolling Motor Accessories

### G-Force™ Trolling Motor Lift Handle - Clamp On Model

- Clamps around Trolling Motor Shaft
- Features G-Force Handle for Optimum Grip to Lift Motor Out of Water
- Fits Motorguide Xi5 Series, Minn Kota Terrova, Riptide & Auto Pilot Series

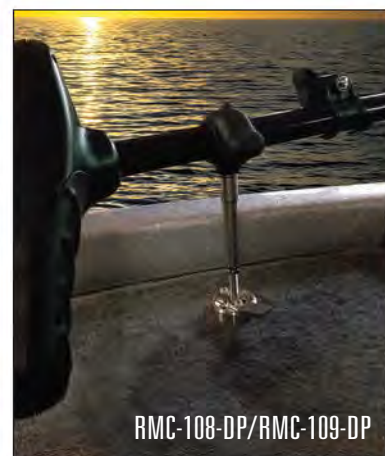

### Troll-Tamer™ Trolling Motor Stabilizer Lock - Clamp On Model

- Ultimate Lock Down Trolling Motor Protection
- Fits Motorguide Xi5 Series, Minn Kota Terrova, Riptide & Auto Pilot Series

Part #	Description
GFH-CA1R-DP	G-Force™ Trolling Motor Lift Handle & Cable w/Trolling Motor Clamp - Red - Wireless Trolling Motors
RMC-108-DP	Troll-Tamer™ Trolling Motor Stabilizer Lock, MK Terrova, Riptide & Auto Pilot/MG Xi5, 5''-8'' spacing
RMC-109-DP	Troll-Tamer™ Trolling Motor Stabilizer Lock, MK Terrova, Riptide & Auto Pilot/MG Xi5, 8''-12'' spacing

TROLLING MOTOR ACCESSORIES





# Troll-Tamer™ Trolling Motor Stabilizer Lock

- Prevents Damage to Trolling Motors
- Locks Motor to Deck Securely
- Models for Most Minn Kota & Motorguide Units
- Locking Pin with Quick Release Toe Kick Base
- All Stainless Steel – No Rust or Corrosion

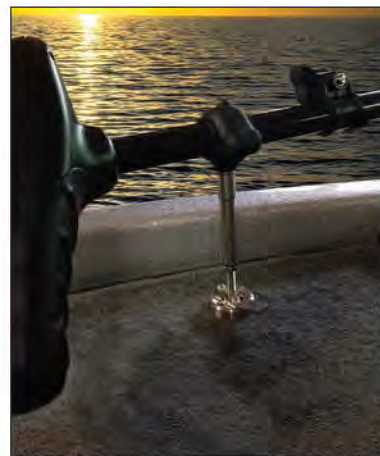

RMC-108-DP/RMC-109-DP

Part #	Trolling Motor Type	Fits	Motor to Deck
RMC-101MG-DP	Foot Controlled	Motorguide	5" to 8"
RMC-101MK-DP	Foot Controlled	Minn Kota - Maxxum	5" to 8"
RMC-101FMK-DP	Foot Controlled	Minn Kota - Fortrex	5" to 8"
RMC-104FMK-DP	Foot Controlled	Minn Kota - Maxxum	3-1/2" to 5"
RMC-105FMK-DP	Foot Controlled	Minn Kota - Maxxum	2-3/4" to 4-1/2"
RMC-108-DP	Wireless	Minn Kota Terrova, Riptide & Auto Pilot - Motor Guide Xi5	5" to 8"
RMC-109-DP	Wireless	Minn Kota Terrova, Riptide & Auto Pilot - Motor Guide Xi5	8" to 12"

# G-Force™ Handle

*Patented Trolling Motor Replacement Lift & Release Cord*

- Stops Cord & Handle Breakage
- Full Grip Cushioned Handle
- 42" Stainless Steel Cable – Nylon Jacket
- Fits Most Trolling Motors
- Hook & Loop Restraint Strap



Endorsed by:  
Gerald Swindle  
B.A.S.S. Elite Pro

Part #	Description	Color
GFH-1R-DP	Replacement Trolling Motor Cord	Red
GFH-1G-DP	Replacement Trolling Motor Cord	Black
GFH-CA1R-DP	Clamp On for Wireless Motor	Red

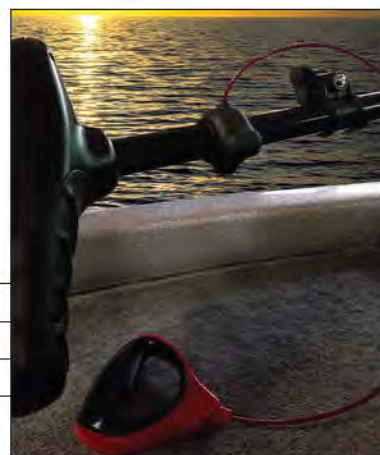

GFH-CA1R-DP

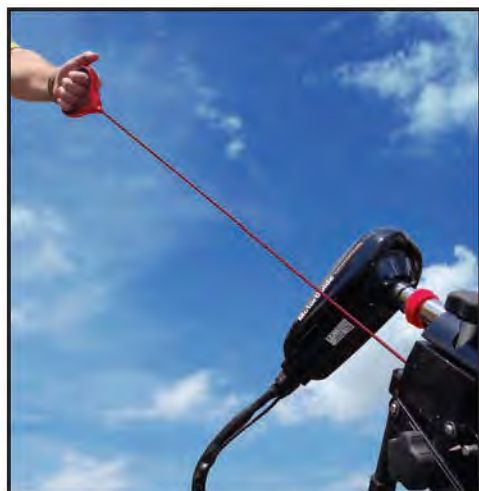

## LANE BLASTER™ LED Trolling Motor Headlight

**NEW!!**

- Blast Out the Dark – Super Bright Spot Beam Headlight
- Mounts Directly to Trolling Motor Mount
- Simple Installation
- Waterproof - IP68 Rated LED Headlight
- Shockproof

- 50,000 Hour Life
- Corrosion Proof Aluminum and Stainless Steel
- 10W Single LED, 1000 Lumens
- Endorsed by BASSMASTER Classic Champion Chris Lane



Part #	Description
LED-TMHL-DP	Trolling Motor Headlight - 10W Single LED - Black Housing

## Bounce Buster Coaster

- Protects Decks from Bounce Buster Damage
- Fits Minn Kota Bow Mount Stabilizer Rods
- Stand-Off Model Fits into Deep Carpet with Pad
- Protects Carpeted Decks from Damage

Part #	Description
BBC-1	Bounce Buster Coaster
BBC-1P	Bounce Buster Coaster with Stand-Off



## Trolling Motor & Charger Power Plugs

- Heavy Duty Use – Handles High Amps
- Water Tight Seal – Gold Contacts
- Original Equipment on Ranger® Boats
- Easily Handles 12 or 24 Volt Systems

Part #	Description
TMBMP-1	Trolling Motor Male Plug - Black
TMFR-1	Female Base Receptacle - Black

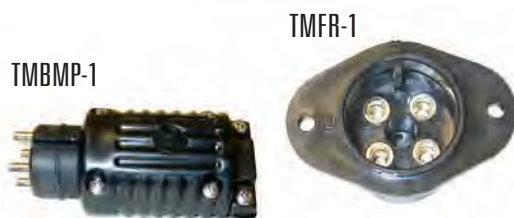

## Trolling Motor Mount

- Cast Aluminum Bracket – Marine Wood Mounting Block
- Designed for Clamp-on Type Electric Trolling Motors

**Important:** Maximum trolling motor thrust of 36 pounds. Motor must be removed and stowed before operating boat or trailering. Not designed for outboards of any horsepower.

Part #	Description
TMM-1-DP	Trolling Motor Mount



## Trolling Motor Circuit Breaker Kit

- Protects Trolling Motors from Damage
- 3' of 8-Gauge Wire to Battery
- Kit Includes Mounting Box, Fasteners & Second Ring Terminal for Attaching Trolling Motor Wire
- Contains 50 Amp Circuit Breaker
- Will Work with 12 or 24 Volt Motors

Part #	Description
CBBK-1-DP	Trolling Motor Circuit Breaker Kit



## Sure Foot™ Trolling Motor Switches

- Foot Control Switch for Electric Trolling Motors
- Rated to 50 AMPS D.C.
- 15° Tilt Angle for Ease of Operation

FCS-1	Sure Foot™ Trolling Motor Switch
FCS-2	Sure Foot™ Trolling Motor Switch with Flip Lever for Continuous "ON"







## Utility Flanges

- Great for Running Wiring, Hoses, Fuel Lines or Plumbing
- Prevents Damage to Stringers and Bulkheads
- Protects Hoses and Wires from Chafing

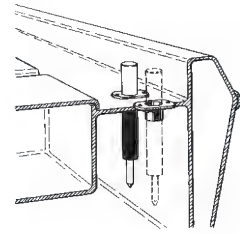

### Utility Flanges - Part Number Information

Black	White	Sand	Size (ID)
PH-1	-	-	1-1/2"
PH-2	-	-	1-3/4"
PH-3	PH3-FW	PH-3S	2-1/2"
TE-1	TE-1W	TE-1S	2-1/4"



## Zippered Rigging Sleeves

- Zips On and Off to Protect Cables and Hoses
- Rugged Sunbrella® - Weather & UV Resistant
- Ends are Secured with Cable Ties

Part #	Description	Size
ZRS-1	Zippered Rigging Sleeve	48" Black



## T-H Flex™ Sleeving

- Lightweight Sleeving - Protects Wire, Cables and Hoses
- Braided from High Temperature Yarns
- Expands Up to Four Times its Normal Diameter

Dia.	O.E.M. Part #	Spool Size	Distributor Part #	Spool Size
			FLX-25-DP	100'
1/2"	FLXB-50	500'	FLX-50-DP	100'
3/4"	FLXB-75	500'	FLX-75-DP	100'
1-1/4"	FLXB-125	500'	FLX-125-DP	50'
1-1/2"	FLXB-150	500'	FLX-150-DP	50'
1-1/2"	FLXB-150FR	500'	Flame Retardant	
2"	FLX-200-DP	50'	FLX-200-DP	50'



## Bulkhead Strain Relief Hose Kit

- Distributes Strain From Bends in Hose
- Water Tight Gripper Fitting — No Leaks
- Great for Hydraulic Steering Hose
- Bulkhead Fitting Has Flange for Protection
- Flange is 2-3/4" Dia. & Requires 1-1/4" Installation Hole

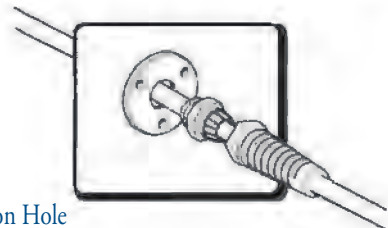

Part #	Description
BSR-1-FH	Bulhead Strain Relief for .250 OD to .485 OD Fuel Hose
BSR-1K	Bulkhead Strain Relief Hose Kit
BSR-1K-CB	Bulkhead Strain Relief - Chrome Brass Base

*Must be Installed Prior to Attaching End Fittings*

## Rigging Flange with Fuel Hose Port & Rigging Flange Hose Union

- Completes Professional Rigging Installation
- Complies with ABYC-NMMA Specs
- Split Design of Union Allows Installation on Pre-Rigged Boats
- Fuel Hose Ports ID = 3/4"
- Installs with 2" ID T-H Marine Rigging Hose

Black	White	Description
RFHU-1		Rigging Flange Hose Union
RFFHP-1	RFFHP-2	Rigging Flange with Fuel Hose Port



Typical Installation shown. Fuel Hose not included.



## Tri-Shape Rigging Flange

- Hose Fits Over Flange and Into Base
- Designed to Prevent Water Leaks
- Fits 2" Hole

Part #	Description
RFT-1	Rigging Flange Only



## Rigging, Flange, Hose Kits

- Protects Cables, Hoses and Wiring from Elements
- Molded Polypropylene Flange Threaded to Retain Hose
- Vinyl Cap Provides Closure for the Engine End of Hose
- Kit Includes Flange & Four (4) Feet of Rigging Hose
- Two Size Flanges for 2" and 2-1/2" ID T-H Marine Rigging Hose

Component	Size	Black #	White #	Chrome #
Flange	Fits 2" ID Hose	RF-1	RF-2	RF-1CP
Flange	Fits 2-1/2" ID Hose	RF-2.5-1		
Hose	2"x50 ft.	RFH-1	RFH-2	
Hose	2-1/2"x50 ft.	RFH-2.5-1		
Rigging Flange & Hose Kit				
RFK-1-DP	Black 2" Rigging Flange & 4 ft. Black Hose			
RFK-1CP-DP	Chrome 2" Rigging Flange & 4 ft. Black Hose			

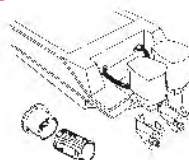

## Nylon Cable Ties

Part # (100/Pack)	Part # (1000/Pack)	Length (Inches)	Description
004B-C	004B-M	4"	Cable Tie
055B-C	055B-M	5-5/8"	Cable Tie
007B-C	007B-M	7-1/2"	Heavy Duty Cable Tie
075B-RAD-C	075B-RAD-M	7-1/2"	Radiused Cable Tie
008B-C	008B-M	8"	Cable Tie
011B-C	011B-M	11"	Cable Tie
014B-C		14"	Cable Tie
145B-C		14"	Screw Mount Cable Tie

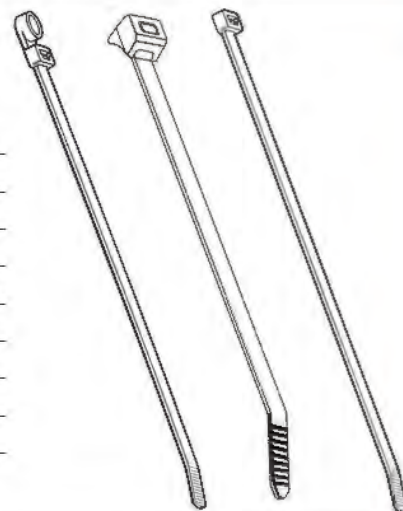





## Oetiker® Stepless® Ear Clamp Kit

- Great for Shop or Rigging Work
- Contains 10 ea. of the 15 Most Needed Sizes (See Chart Below)
- Complete with Crimping Tool

Part #	Description
18500000	Stepless® Clamp Rigging Kit



## Oetiker® Stepless® Ear Hose Clamps

- Forms a Full 360 Degree Circle
- Tongue and Groove Interlock Design
- Fast Clamping with Tool
- No Leaks Around Hose
- Stainless Steel
- 100 ea. per Bag

Part #	Description	Size	Included in Kit
16700001	Stainless Steel Stepless® Ear Clamp	5.8 - 7.0mm	Y
16700004	Stainless Steel Stepless® Ear Clamp	7.8 - 9.5mm	Y
16700006	Stainless Steel Stepless® Ear Clamp	8.8 - 10.5mm (3/8)	Y
16700007	Stainless Steel Stepless® Ear Clamp	9.6 - 11.3mm	Y
16700010	Stainless Steel Stepless® Ear Clamp	10.8 - 13.3mm	Y
16700011	Stainless Steel Stepless® Ear Clamp	11.0 - 13.8mm (1/2)	Y
16700012	Stainless Steel Stepless® Ear Clamp	11.5 - 14.0mm	Y
16700013	Stainless Steel Stepless® Ear Clamp	12.0 - 14.5mm	Y
16700016	Stainless Steel Stepless® Ear Clamp	13.2 - 15.7mm	Y
16700017	Stainless Steel Stepless® Ear Clamp	14.5 - 17.0mm (5/8)	Y
16700020	Stainless Steel Stepless® Ear Clamp	15.3 - 18.5mm	Y
16700024	Stainless Steel Stepless® Ear Clamp	17.8 - 21.0mm (3/4)	Y
16700031	Stainless Steel Stepless® Ear Clamp	22.4 - 25.6mm (1)	Y
16700037	Stainless Steel Stepless® Ear Clamp	26.9 - 30.1mm (1-1/8")	Y
16700040	Stainless Steel Stepless® Ear Clamp	28.4 - 31.6mm	Y
16705000	Stainless Steel Stepless® Ear Clamp	34.9 - 38.1mm (1-1/2)	Y
16705989	Stainless Steel Stepless® Ear Clamp	37.8 - 41.0mm	Y
14100396	Standard Jaw Pincer Pliers		Y

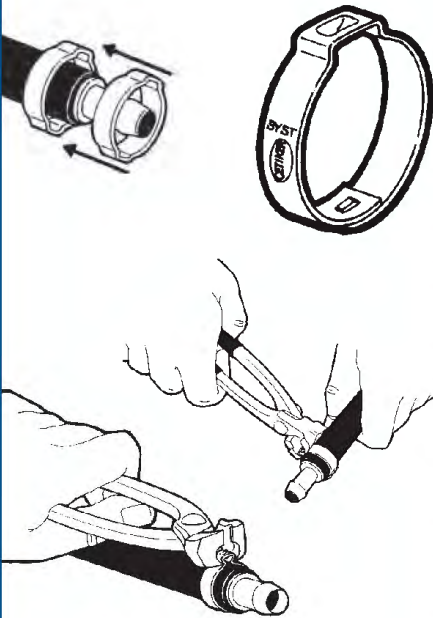

## Oetiker® Hose Clamps

- Clamp On – Quick & Secure
- Single Ear – All Stainless Steel
- Full Size Range for All Marine Hose

Part #	Description	Nominal Size	Part #	Description	Nominal Size			
15500070	101R	25/64"	15500019	316R	1-1/4"			
15500000	105R	3/8"	15500020	331R	1-5/16"			
15500001	113R	7/16"	15500021	346R	1-3/8"			
15500003	133R	1/2"	15500022	361R	1-7/16" (1-1/8")			
15500006	140R	35/64"	15500023	376R	1-15/32"			
15500007	145R	9/16"	15500024	381R	1-1/2"			
15500008	157R	5/8"	15500030	470R	1-13/16" (1-1/2")			
15500009	170R	11/16"	15500031	485R	1-7/8"			
15500010	185R	23/32"	15500032	500R	1-15/16"			
15500011	198R	3/4"	15500033	615R	2"			
15500012	210R	13/16"	<b>OETIKER CLAMP INSTALLATION TOOLS</b>					
15500013	226R	7/8"						
15500014	241R	15/16"						
15500015	256R	1" (3/4")						
15500016	271R	1-1/16"						
15500017	286R	1-1/8"						
15500018	301R	1-3/16"						
						<b>Part #</b>	<b>Description</b>	
						14100396	Standard Jaw Pincers (formerly 14100118)	
						14100387	Side Jaw Pincers (formerly 14100083)	



**NEW!!**



## Stainless Steel Hose Clamps

Part #	Item	Hose Size (OD)
HC-4	Stainless Steel Hose Clamps	7/32" to 5/8"
HC-6	Stainless Steel Hose Clamps	3/4" to 7/8"
HC-8	Stainless Steel Hose Clamps	7/16" to 1"
HC-10	Stainless Steel Hose Clamps	7/16" to 1-1/16"
HC-12	Stainless Steel Hose Clamps	7/16" to 1-1/4"
HC-16	Stainless Steel Hose Clamps	1 1/16" to 1-1/2"
HC-24	Stainless Steel Hose Clamps	1" to 2"
HC-28	Stainless Steel Hose Clamps	1-1/4" to 2-1/4"



## Wire/Hose Hanger

- Secures Wiring Harness or Hoses
- Can Be Glassed In or Screwed Down
- Fits Standard Cable Ties
- Molded – Non Corrosive



Part #	Description
WHH-1	Wire/Hose Hanger
WHH-1KIT-DP	Kit consists of: 10 Ea. Hangers - Cable Ties - Double Stick Tape

## Decorative Wire Cover

- Covers Wire Pass-Thru Holes
- Provides a Finished Look for Wiring

Part #	Description
DWC-1	Decorative Wire Cover



## Vent Hose Flanges

- Fits 3" or 4" I.D. Wire Supported Vent Hose
- Barbs Prevent Hose from Slipping Off

Black #	Sand #	Description
VHF-3	VHF-3WS	Vent Hose Flange, 3"
VHF-4	VHF-4WS	Vent Hose Flange, 4"



## Cable Boot Grommets

- Protects Cables, Hoses and Wires from Chafing
- Flange Fits into Pass-Thru Hole
- Cable Boot Snaps into Grommet

Black #	Fits
CBG-2	CB-2
CBG-1	CB-1
CBG-4	CB-4







## Reinforcing Rings for Cable Boots

Black #	Fits
CBR-1	CB-1
CBR-2	CB-2
CBR-4	CB-4



## Cable Boots

- Finishes & Protects Pass Thru Hole for Wires & Cables
- Rugged Marine Vinyl — Resists UV, Gasoline and Oil
- Cable Tie Snugs Around Wires and Cables

Black #	White #	Fish White #	Size
CB-2	CB-2W	CB-2FW	2" Boot
CB-1	CB-1W	CB-1FW	3" Boot
CB-4	CB-4W	CB-4FW	4-1/2" Boot



## Rope Grommets

- Fits 3" Hole
- Prevents Chafing
- Molded Poly
- Flange Diameter – 3-7/8"

Part #	Description
RG-1	Rope Grommet - Black



UG-1

## Utility Grommets

- Protects Items Passing Thru Bulkheads, Braces or Stringers
- Marine Grade Flexible Vinyl

Part Numbers			Dimensions (inches)	
Black	White	Fish White	O.D.	Max Hole Size
UG-1	UG-1W	UG-1FW	3-3/8	2-3/8
UG-2	UG-2W	UG-2FW	2-3/4	1-3/4
UG-3	UG-3W	UG-3FW	4	3



UG 2 & UG-3



## Oval Grommet

- Provides Protection for Cables and Wiring

Part #	Description	Size (OD)	Fits Hole Size
OG-1	Oval Grommet - Small	3.83" x 2.32"	1-1/2" x 3"
OGL-1	Oval Grommet - Large	3" x 9"	2" x 8"



## Clam Shell Vents

- Available in Stainless Steel or Plastic

Black	White	Stainless Steel	Hole Size
CS-1	CS-2	CS-1SS	9/16 x 1-7/8"
CSS-1	CSS-2	CSS-1SS	7/16 x 7/8"
		CS-SS-3	1-5/8" x 2-1/2"





# AQUA-BLAZE





# UNDERWATER LED LIGHTS



## Premium LED Underwater Light

- Super Bright
- Six High Intensity LEDs – Newest Generation
- Stainless Steel Bezel – No Rust or Corrosion
- Surface Mount Installation

LED-39060 Premium LED Underwater Light - White

LED-39061 Premium LED Underwater Light - Blue

LED-39062 Premium LED Underwater Light - Green



## High Output Underwater LED Fishing Light



Part #	Description
LED-34154	High Output Underwater LED Fishing Light

- Waterproof Light Housing
- 18' Power Cable
- Green LED Lights for Maximum Fish Attraction
- 180 LED/5-Side Design for 360 Degree Light Output
- Light is Weighted to Maintain the Desired Depth Range

**NEW!!**

LED LIGHTING

## High Intensity LED Underwater Lights

**Affordable and Totally Waterproof**

These waterproof, high-intensity LED underwater lights are designed to be used above or below the water line. A broad flood light effect is created by the engineered optics of the convex light face. Compared to other LED models, this light has greater light output and a wider aperture.

- Surface Mount or Small Hole for Wiring
- 6 Super Bright LED's
- Lower Amperage Draw and Longer Life than Conventional Bulbs
- 100,000 Hour Life
- No High Heat Like Most other Underwater Lights
- White, Blue or Green Illumination
- Also Suggested for Transoms, Trim-Tabs and T-Tops
- Stainless Steel Hardware Included
- Dimensions: Surface Size: 3.5" x 1.5"

Height: 1.2" with Mounting Spacer or 0.7" without Spacer



*Proven to attract bait fish during night trips and add ambiance to any vessel.*

LED-39055	Underwater LED Light	6 Red LEDs
LED-51866	Underwater LED Light	6 White LEDs
LED-51867	Underwater LED Light	6 Blue LEDs
LED-51868	Underwater LED Light	6 Green LEDs



## Underwater LED Light with Stainless Steel Bezel

- 316 Stainless Steel Bezel
- Six Bright LEDs – Lights Up Transoms
- No High Heat – Can Be Used Above Water

LED-51900 Stainless Steel Underwater LED Light - White

LED-51901 Stainless Steel Underwater LED Light - Blue

For more: Visit

2017 Marine Ave [www.thmarine.com](http://www.thmarine.com)



# UNDERWATER LED LIGHTS

## Fully Encapsulated Underwater LED Light

- Heavy Duty Die Cast Aluminum Housing with Powder Coated Finish
- Fits Most Trolling Motor Models
- High Output LED – Night Time Navigation
- Marine Tinned Wire
- Low Amp Draw

**NEW!!**

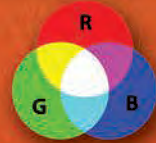

Part #	Description	LED Color
LED-33990	6 LED Underwater Light, Fully Encapsulated, Oblong	White
LED-33991	6 LED Underwater Light, Fully Encapsulated, Oblong	Blue
LED-33992	6 LED Underwater Light, Fully Encapsulated, Oblong	Green
LED-33993	6 LED Underwater Light, Fully Encapsulated, Oblong	RGB

## Stainless Steel Oval LED Underwater Light

T-H Marine introduces a high quality underwater light. This surface mount, stainless steel underwater light is highly attractive, with superior brightness and durable construction. Completely waterproof, this 316 stainless steel bezel light will last for many years in the toughest marine environments.

- Waterproof - IP68 Rated
- Overheat Protection
- Resistant to Corrosion, UV and Chemicals
- Impact Resistant
- Fully Sealed and Waterproof Light
- Very Easy to Install with Two (2) Screws and Small Wiring Hole
- Six (6) Super Bright LED Diodes
- Size: 5.7" x 1.7"
- Available in LED Colors of White, Blue, Green, RGB

**NEW!!**



Part #	Description	LED Color
LED-SM7815-W	SS Oval Underwater Light - 5.7" x 1.7" - 6 LEDs	White
LED-SM7815-B	SS Oval Underwater Light - 5.7" x 1.7" - 6 LEDs	Blue
LED-SM7815-G	SS Oval Underwater Light - 5.7" x 1.7" - 6 LEDs	Green
LED-SM7815-RGB	SS Oval Underwater Light - 5.7" x 1.7" - 6 LEDs	RGB

## Extreme LED Underwater Light

- Extreme Output LED Underwater Light – Surface Mount
- 20% Brighter than Our Standard LED Underwater Light
- Brighter than Competitor Underwater Lights of Same Size
- High Impact Polymer Construction
- Completely Waterproof – For Use Underwater or Above Water
- Polarity and Thermal Protection

**NEW!!**



Part #	Description	LED Color
LED-SM171COB-W	Extreme LED Underwater Light - Oval 3.5" x 1.5"	White
LED-SM172COB-B	Extreme LED Underwater Light - Oval 3.5" x 1.5"	Blue
LED-SM173COB-G	Extreme LED Underwater Light - Oval 3.5" x 1.5"	Green

LED LIGHTING





# LED SPREADER LIGHTS

LED LIGHTING



## Oval Recessed Mount Spreader LED Light

- Super Bright White 4 Element LEDs
- Powder Coated Aluminum Case
- Recessed Mounting – Fits T-Top Molded Enclosures
- Flood Light Spread Illuminates Decks Fully
- Dimensions: 5-7/8" L x 1-3/4" W x 1-5/8" D



LED-39120	Oval Recessed Flush Mount Spreader - White Housing
LED-39122	Oval Recessed Flush Mount Spreader - Black Housing
LED-39112SB	316 Stainless Bezel Covers for Oval Spreaders

## LED Super Spreader Light

### Blazing Illumination Turns Night Into Day

Flood your boat deck with bright and smooth illumination to make low light or night fishing safer and easier.

- Five (5) Super High Intensity 1W LEDs
- Great for New Installations or replacing 55W Halogen Flood Lights
- Provide Smooth, Bright, Even Light to the Entire Boat Deck
- Power Consumption 80% Lower than Incandescent Lights
- Die-cast Aluminum Housing, Powder Coated
- Optical grade PMMA lens
- Color Temperature: 6000K
- Super Long Life up to 30,000 Hours (30% longer than competition)
- Mounting Bracket and Hardware: 316 Stainless Steel
- Simple, Single Bolt Installation
- Operating Voltage: 10-30V DC
- Waterproof – IP67 Rating

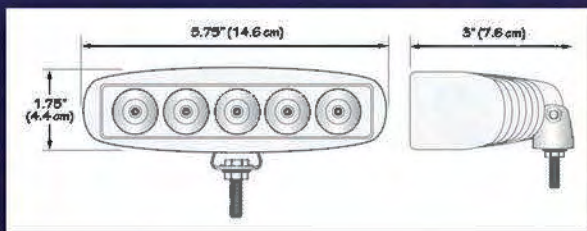

LED-39094	LED Super Spreader - Bolt/Gimble Mount - Black Housing
LED-51914	LED Super Spreader - Bolt/Gimble Mount - White Housing







# LED SPREADER LIGHTS

## LED Mini Spreader

- 2" LED Round Mini Spreader Light / Docking Light
- Die-Cast Aluminum Body with Matte Black or White Finish
- 1000 Lumens, High-Output Single 10W LED for a Bright, Narrow Spot Beam Pattern
- Impact-Resistant Polycarbonate Lens
- Waterproof - IP68 Rated
- Reverse Voltage Protection
- Draws 1.3A @ 12V
- Stainless Steel Mounting Hardware

LED-39690 LED Mini Spreader - 10W - White Housing - Spreader or Docking Light

LED-39691 LED Mini Spreader - 10W - Black Housing - Spreader or Docking Light



## LED Side Docking Light

- LED-51888 • Stainless Steel Housing - 5Ds - White Housing
- Low Profile Design
- Extreme Output LED Lighting for Docking at Night

LED-319DL LED Side Docking Light

**NEW!!**

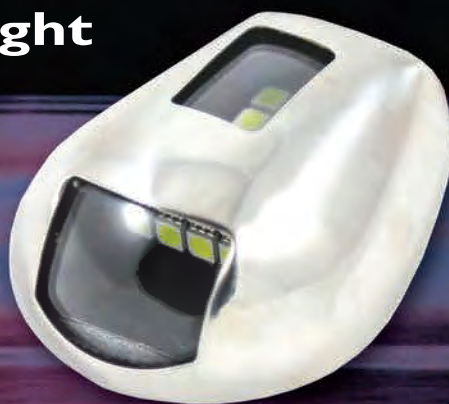

## Recessed Flush Mount LED Spreader Light

- Four Bright High Intensity LEDs
- Flush Mount Fits into T-Top Recesses
- Powder Coated Aluminum
- Wide 145 Degree Angle Light Spread
- 4 Watts
- Waterproof - IP67 Rating
- Dimensions: 4-7/8" L x 1-3/4" W x 1-5/8" D



LED-51905

Recessed Flush Mount LED Spreader

Black Powder Coating

LED-51913

Recessed Flush Mount LED Spreader

White Powder Coating





# LED NAVIGATION LIGHTS



LED-BNAVC-1

## LED Navigation Lights – Combination Bow

**NEW!!**

- Two Versions of Compact and Low Profile Bow Nav Lights
- Combination Bow Navigation Light
- 316 Stainless Steel Housing
- 2 Nautical Mile USCG Certification
- Waterproof



LED-LPBNAVC-1



Part #	Description
LED-BNAVC-1	LED Combination Bow Navigation Light - Stainless Housing, Gasket & Hdwr. Dimensions: 2-3/8" L x 2-1/16" W x 7/8" H
LED-LPBNAVC-1	Low Profile Combination Bow Navigation Light - Stainless Flush Mount Dimensions: 2-3/8" L x 1-7/8" W x 1" H

LED LIGHTING



## LED Navigation Lights – Single Side Bow Lights

**NEW!!**

- Lowest Footprint of Any Single Color LED Navigation Bow Light
- 316 Stainless Housing
- 2 Nautical Mile USCG Certification
- Available in Horizontal Deck Mount, Vertical Straight Mount, and Vertical Angle Mount

Part #	Description	Mounts	Dimensions
LED-LPNAV-1	Low Profile Bullet Nav Lights - Port/Stbd Pair	Horizontal Deck Mount	2-1/4" L x 1" W x 11/16" H
LED-LPNAV-2	Low Profile Bullet Nav Lights - Port/Stbd Pair	Vertical Angle Mount	2-1/4" L x 1" W x 11/16" H



# LED NAVIGATION LIGHTS

## LED Flex Strip Bow Lights

- Red and Green Set of Lights
- Super Bright
- Ideal for Kayaks and Small Boats for Visibility
- Not Tested for USCG Certification

**NEW!!**



Part #	Description
LED-52000-DP	LED Flex Strip Bow Light Kit - Red & Green Combination - 6" - 12V

**NEW!!**

## LED Bow Light Combination Kit – Battery Operated

- Same Features as Our LED-52000-DP
- Now Operable with Waterproof Battery Pack
- Perfect for Canoes, Kayaks, and Other Small Craft
- Not Tested for USCG Certification



Part #	Description
LED-39306-DP	LED Bow Light Combination Kit



## Shark Eye Nav Lights

- Available in LED or Incandescent Models
- Certified to meet ABYC A-16 & USCG
- NMMA Type Accepted
- Stainless Steel Base – Tin Wire
- Green Lens and Red Lens in Set
- Each Light is 7-1/2" L and 2-1/4" W

Part #	Description
SEL-1LED-DP	LED Shark Eye Lights - One Pair - 2NM
SEL-1-DP	Incandescent Shark Eye Lights - One Pair - 1NM





# LED NAVIGATION LIGHTS

## LED Stern Light

**NEW!!**

- LED Lighting for Maximum Visibility
- Low Amp Draw for Long Battery Life
- Fits in Standard Light Base
- Available in Fixed, Adjustable and Folding Sizes
- USCG Certified

LED-39503	LED Stern Light, All Around Navigation Light, 24"
LED-39507	LED Stern Light, All Around Navigation Light, 36"
LED-39509	LED Stern Light, All Around Navigation Light, 48"
LED-39510	LED Stern Light, All Around Navigation Light, 54"
LED-39757	LED Stern Light, All Around Navigation Light, Adjustable 28"-48"
LED-39513	LED Stern Light, All Around Navigation Light, Adjustable 37"-67"
LED-39758	LED Stern Light, Folding All Around Navigation Light
LED-39759	LED Stern Light, Fixed All Around Navigation Light, 5"
LED-39771	LED Stern Light, Folding, All Around Navigation Light, 24.2" - 41.7"
LED-39772	LED Stern Light, Adjustable, All Around Navigation, USCG Cert., 28" - 48"



LED LIGHTING



## Base Stern - 2-Prong

**NEW!!**

- Available in High Impact Corrosion Resistant Nylon Design, Chrome Zamack Finish or Stainless Steel Housing
- 2-Prong
- Pre-Wired Pigtail Wiring Harness
  - Rubber or Tethered Cover Keeps Inside Base Clean and Dry
  - Available with Locking Swivel Top

LED-NAV-39522	Stern Light Base, Nylon Low Profile, 2-Prong
LED-NAV-39762	Stern Light Base w/ Cover, Zamack, 2-Prong
LED-NAV-39526	Stern Light Base, Swivel Top, Nylon
LED-NAV-39524	Stern Light Base, Nylon, Low Profile, 2-Prong
LED-NAV-39525	Stern Light Base, Stamped SS, Round







# LED NAVIGATION LIGHTS

## Bimini Top Light

- LED Fold Down, All Around Pontoon Lights are Approved for USCG 2NM (Colreg 2mile)
- Injection Molded Nylon
- 3/16" Stainless Base
- Mounts on 1-1/4" Square Tubing
- Mounts on 3/4" Round Tubing
- 24" and 36" Light Available

**NEW!!**



Part #	Description	Size
LED-BTSL-24	Bimini Top Light	24" Light
LED-BTSL-36	Bimini Top Light	36" Light



**NEW!!**

## Snap Flex Base

- Patented Design Quick-Release Base
- 3/16 Stainless Base
- UV Stable Cover Keeps Water Out When Not in Use
- Easily Mounted with 3 Screws (NOT PROVIDED)

Part #	Description
LED-NAVSFSB	Snap Flex Stern Light Base

## Snap Flex Stern Light

- Patented Design Quick-Release Stern Light
- UV Stable Fiberglass Shaft /Flexible
- Two-mile USCG-Approved LED Configuration
- Light Features a Spring-Loaded Locking RCA CAM that Prevents the Fiberglass Light from Walking Out of the Base

Part #	Description
LED-NAVSFSL-48	Snap Flex Stern Light

**NEW!!**



LED LIGHTING



# LED LIGHT KITS



## LED Lighting Kit for Boats

- Complete Kit for Installing Accent LED Lights to Any Boat
- See to Work on Tackle or Gear in the Dark
- Kits Available in Bright White, Blue or Red LEDs

Kit Includes:

- 3 ea. of our 4" Slim Line LED Utility Lights
- 4 ea. of our 12" Flex Strip LED Lights
- 2 ea. of our 24" Flex Strip Lights

Part #	Description	LED Color
LED-BTKIT-WHT	LED Lighting Kit for Boats	White LEDs
LED-BTKIT-BLUE	LED Lighting Kit for Boats	Blue LEDs
LED-BTKIT-RED	LED Lighting Kit for Boats	Red LEDs
LED-BTKIT-GREEN	LED Lighting Kit for Boats	Green LEDs



LED LIGHTING

## LED Lighting Kit for Trailers

- Make Your Trailer More Visible at Night
- Attaches to Any Trailer Frame
- High Bond 3M Adhesive on Flex Strips

Kit Includes:

- 2 ea. of our 24" Flex Strip LED Lights
- 2 ea. of our 48" Flex Strip Lights

Part #	Description	LED Color
LED-TRLKIT-WHT	LED Lighting Kit for Trailers	White LEDs
LED-TRLKIT-BLUE	LED Lighting Kit for Trailers	Blue LEDs
LED-TRLKIT-RED	LED Lighting Kit for Trailers	Red LEDs
LED-TRLKIT-GREEN	LED Lighting Kit for Trailers	Green LEDs

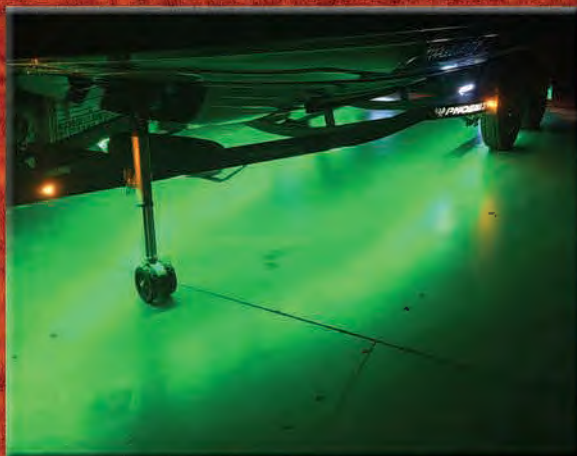



# LED LIGHT KITS

## High Intensity Oval LED Courtesy Light/ Rock Light Kits

- Lights Up Boat Deck for Late Night or Early Morning Tackle Rigging
- Extreme High Output Lights
- Waterproof and Shockproof
- Available in 2 Pack or 6 Pack Kits
- 6 Pack Kits are Available in Single or Two Colors
- Kits Include:
  - 6 Pack:
    - 6 LED Lights
    - 2 Switches
    - 6 Flat Rubber Mounting Plates
    - Mounting Screws and Bolts
  - 2 Pack:
    - 2 LED Lights
    - 1 Switch
    - 2 Angled Rubber Mounting Plates
    - Mounting Screws and Bolts



### 6-LED Kits

Part #	Bezel Color	Light Colors	Number of Lights
LED-33253-6KT	White	Blue	6
LED-33255-6KT	Black	White	6
LED-33256-6KT	Black	Blue	6
LED-33257-6KT	Black	Red	6
LED-33308-6KT	Black	Green	6
LED-33309-6KT	Black	Amber	6
LED-32650-6KT	Black	RGB	6
LED-32651-6KT	White	RGB	6
LED-RKRW-6KT	Black	Red (4), White (2)	6
LED-RKBW-6KT	Black	Blue (4), White (2)	6
LED-RKGW-6KT	Black	Green (4), White (2)	6
LED-RKAW-6KT	Black	Amber (4), White (2)	6

### 2-LED Kits

Part #	Bezel Color	Light Colors	Number of Lights
LED-33253-2KT	White	Blue	2
LED-33255-2KT	Black	White	2
LED-33256-2KT	Black	Blue	2
LED-33257-2KT	Black	Red	2
LED-33308-2KT	Black	Green	2
LED-33309-2KT	Black	Amber	2
LED-32650-2KT	Black	RGB	2
LED-32651-2KT	White	RGB	2



LED LIGHTING



# PONTOON LED LIGHT KITS

T-H Marine has you covered for Pontoon Boat Under Deck LED Light Kits. All kits include everything you need to brilliantly light up your pontoon, to create an incredible indirect lighting effect under your deck, on your pontoons, and reflecting off the water. Have more fun at night by making your pontoon come alive with LED lighting. Unlike most kits on the market, our entire kits are IP68 Waterproof and fully submersible, marine grade systems.

LED LIGHTING



## Pontoon LED Module String Light Kit – Blue

- Most Economical Pontoon Kit Available
- IP68 - Fully Waterproof and Submersible
- Includes: Two 25' Long LED Module Strings Containing 24 3-LED Modules Per String
- Strings Include Additional 20' of Wire Pigtail to Route to Control Switch
- Simple Installation: Mounts with Adhesive Strips or Fasteners

Part #	Description
LED-34160-DP	LED Pontoon Boat Light Kit, 2x25' LED Module String, 20' Wiring, Packaged, Blue







# PONTOON LED LIGHT KITS



## Pontoon LED Flat Flexible Ribbon LED Strip Light Kit – Blue

**NEW!!**

- IP68 - Fully Waterproof and Submersible – Silicone Tube with Silicone Gel Fill
- Includes: Two 20' or 25' Long IP68 LED Light Strips, Waterproof Wiring Harness, and Mounting Channels
- Simple Installation: Mounts with Adhesive Strips Pre-installed on Mounting Channels

Part #	Description
LED-PBDK20B-DP	Pontoon Boat Under Deck LED Light Kit - Blue - 16-22' Boats - 6m/20ft LED Strips
LED-PBDK25B-DP	Pontoon Boat Under Deck LED Light Kit - Blue - 24-30' Boats - 7.5m/25ft LED Strips

## Pontoon LED Flat Flexible Ribbon LED Strip Light Kit – RGB Color Changing

- Dazzling Light Show Effects with RGB Color Changing Lights with Many Controller Features
- IP68 - Fully Waterproof and Submersible – Silicone Tube with Silicone Gel Fill
- Includes: IP68 RGB Controller with Remote Control, Two 20' or 25' Long IP68 LED Light Strips, Waterproof Wiring Harness, and Mounting Channels
- Simple Installation: Mounts with Adhesive Strips Pre-installed on Mounting Channels

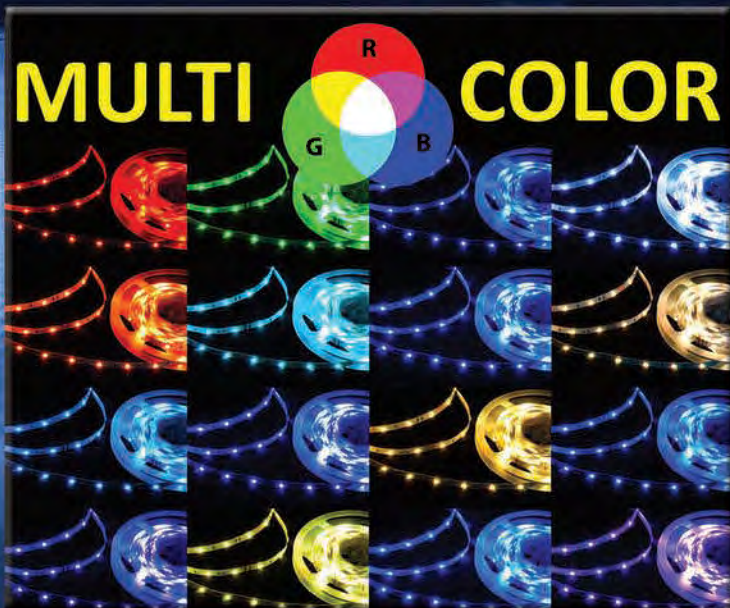

Part #	Description
LED-PBDK20RGB-DP	Pontoon Boat Under Deck LED Light Kit - RGB - 16-22' Boats - 6m/20ft LED Strips
LED-PBDK25RGB-DP	Pontoon Boat Under Deck LED Light Kit - RGB - 24-30' Boats - 7.5m/25ft LED Strips

LED LIGHTING





# LINEAR LED LIGHTING



## LED Flex Strip Lights

### Add Wow to Your Boat

- Can Be Cut to Lengths
- Moisture and Water Resistant
- Strong 3M Mounting Tape on Back
- Available in 1 ft., 2 ft., 4 ft. & 6 ft. Strips
- LED Colors: White, Blue, Red & Green, White/Blue Combo

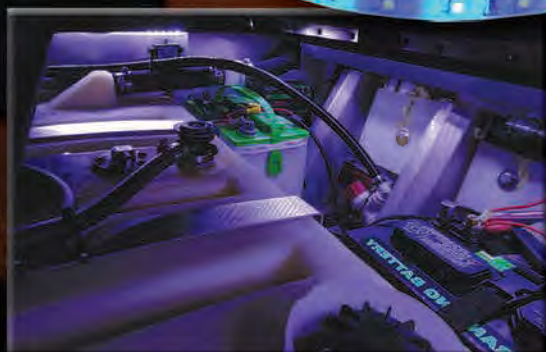

LED-51946	Flex Strip Lights	12"	White LED
LED-51947	Flex Strip Lights	12"	Blue LED
LED-51948	Flex Strip Lights	12"	Red LED
LED-51949	Flex Strip Lights	12"	Green LED
LED-51950	Flex Strip Lights	24"	White LED
LED-51951	Flex Strip Lights	24"	Blue LED
LED-51952	Flex Strip Lights	24"	Red LED
LED-51959	Flex Strip Lights	24"	White/Blue Combo LED
LED-51965	Flex Strip Lights	24"	Green LED
LED-51953	Flex Strip Lights	48"	White LED
LED-51954	Flex Strip Lights	48"	Blue LED
LED-51955	Flex Strip Lights	48"	Red LED
LED-51961	Flex Strip Lights	48"	White/Blue Combo LED
LED-51966	Flex Strip Lights	48"	Green LED
LED-51956	Flex Strip Lights	72"	White LED
LED-51957	Flex Strip Lights	72"	Blue LED
LED-51963	Flex Strip Lights	72"	White/Blue Combo LED
LED-RLC	Strip Light Mounting Channel - No Tape - 6' Lengths		
LED-RLC-WT	Strip Light Mounting Channel - With Tape - 6' Lengths		

LED LIGHTING





# LINEAR LED LIGHTING

## LED Flat Rope Lights

- Bright LED Continuous Rope Lights
- Lengths from 14 ft. to 28 ft.
- Blue, White & Green LEDs for Accents  
(Request info for Green Lights)
- Mounting Channel has 3M High Tenacity Tape

LED-SM14-B	LED Rope Lighting	14'	Blue
LED-SM16-B	LED Rope Lighting	16'	Blue
LED-SM18-B	LED Rope Lighting	18'	Blue
LED-SM20-B	LED Rope Lighting	20'	Blue
LED-SM22-B	LED Rope Lighting	22'	Blue
LED-SM24-B	LED Rope Lighting	24'	Blue
LED-SM26-B	LED Rope Lighting	26'	Blue
LED-SM28-B	LED Rope Lighting	28'	Blue
LED-SM14-W	LED Rope Lighting	14'	White
LED-SM16-W	LED Rope Lighting	16'	White
LED-SM18-W	LED Rope Lighting	18'	White
LED-SM20-W	LED Rope Lighting	20'	White
LED-SM22-W	LED Rope Lighting	22'	White
LED-SM24-W	LED Rope Lighting	24'	White
LED-SM26-W	LED Rope Lighting	26'	White
LED-SM28-W	LED Rope Lighting	28'	White
LED-SMSLC-6WT	Flat Rope Light Mounting Channel - 6 ft Length		



LED LIGHTING

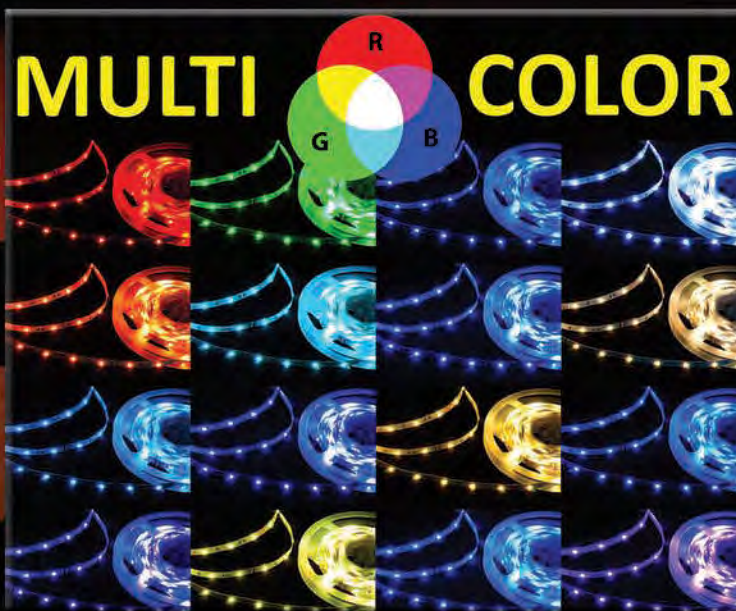

## LED Flat Rope Lights – RGB Color Changing **NEW!!**

Create awesome colors and light shows on your boat or trailer with our RGB Color Changing Flat Rope LED Light strips. Unlike other RGB systems, ours are marine grade, IP68 waterproof, and fully submersible, including our RGB controller.

- Dazzling Light Show Effects with RGB Color Changing Lights with Many Controller Features
- IP68 - Fully Waterproof and Submersible – Silicone Tube with Silicone Gel Fill
- Light Strips, Controllers with Remotes, Mounting Channel, and Rubberized Clips Available Separately to Build Any System You Need.
- High Output, Super Bright, Super Flexible
- 12V DC, 7.2 Watts Per Meter, 0.6 Amps Per Meter
- 432 Lumens Per Meter

LED-SM16-RGB	LED Flat Silicone Ribbon LED Light Strip, RGB Color Changing, 5m/16'
LED-SM20-RGB	LED Flat Silicone Ribbon LED Light Strip, RGB Color Changing, 6m/20'
LED-SM25-RGB	LED Flat Silicone Ribbon LED Light Strip, RGB Color Changing, 7.5m/25'
LED-SMSLC50-4WT	Track for LED Flat Rope Light Strip (5050 LED) with Mounting Tape, 4' Long
LED-ROPKIT-X	Mounting Clips and Screws for LED Flat Rope Light Strips, quantity = x
LED-RGBCONT-1	RGB LED Light Controller (IP68 Waterproof) with Remote Control



# LINEAR LED LIGHTING

## LED Flex Strip Lights with Track

- Super Bright LED Flex Strip Lights in Convenient to Mount Sizes
- Great for Any Courtesy Light Application
- Perfect for Lighting in Storage Compartments
- Includes Low Profile and Easy to Mount Track and Ends
- Completely Waterproof
- 2 Background Flex Colors – White and Black
- 3 Lengths – 4", 6", 12"
- 4 Colors – White, Blue, Green, Red

**NEW!!**

White PCB Strip

Black PCB Strip



LED Flex Light Strip Color	Size	Part # - LED Color			
		White	Blue	Green	Red
White PCB strip, Track, Ends & Hdwr.	4"	LED-39328	LED-39329	LED-39330	LED-39331
White PCB strip, Track, Ends & Hdwr.	6"	LED-39320	LED-39321	LED-39322	LED-39323
White PCB Strip, Track, Ends & Hdwr.	12"	LED-33267	LED-33268	LED-33269	LED-33270
Black PCB strip, Track, Ends & Hdwr.	4"	LED-33279	LED-33280	LED-33281	LED-33282
Black PCB strip, Track, Ends & Hdwr.	6"	LED-33275	LED-33276	LED-33277	LED-33278
Black PCB strip, Track, Ends & Hdwr.	12"	LED-33271	LED-33272	LED-33273	LED-33274

LED LIGHTING

## LED Flex Strip Lights – Battery Operated

**NEW!!**

- All the Features of T-H Marine 12V LED Flex Strip lights in a Convenient Battery Operated Version
- Allows for Lighting where Running Electrical Wiring is Difficult
- Waterproof Battery Box
- Uses Three (3) AA Batteries
- 18" Strips Available in Three Colors – White, Blue, Green



Part #	Description	Length	Color
LED-39275	LED Flex Strip Light, Battery Operated	18"	White
LED-39276	LED Flex Strip Light, Battery Operated	18"	Blue
LED-39277	LED Flex Strip Light, Battery Operated	18"	Green

## LED Flex Strip Lights – Mounting Track & Track Ends

- For Use with T-H Marine LED Flex Strip Lights
- For Convenient and Secure Mounting of T-H Marine LED Flex Strip Lights
  - Ends Fit into Track to Provide for Screw Mounting
  - Ends Available in Black and White
  - Track Available in Clear, Black, and White



Part #	Description
LED-39532	Flex Light Track Ends - White - 100 pack
LED-39533	Flex Light Track Ends - Black - 100 pack
LED-39536	Clear Poly-Carb. Flex Light Track with Adhesive - 6' Long
LED-39537	Black Poly-Carb. Flex Light Track with Adhesive - 6' Long
LED-39538	White Poly-Carb. Flex Light Track with Adhesive - 6' Long



# LINEAR LED LIGHTING

## LED Flex Strip Lights – Ultraviolet LED Strip Lights

- Same Features as Our Other LED Flex Strip Lights
- Now Available in Ultraviolet LEDs/UV LEDs
- Great for Night Fishing

Part #	Description
LED-UV24-DP	LED Flex Strip Lights - Ultraviolet/UV - 27.25" strip
LED-UV24TRK-DP	LED Flex Strip Lights - Ultraviolet/UV - 27.25" strip w/ track



**NEW!!**



## Flexible LED Light Bar

- Available in 9 LED and 12 LED Light Bars
- Great for T-Top Lights
- Mount on Curved Surfaces
- Flexible Silicon Housing
- 100% Waterproof
- Available in White, Blue, and Blue/White Combinations

**NEW!!**



Part #	Description	# LED	Color	Dimensions
LED-39685	Flexible LED Light Bar	9 LED	White	10.34" L x 1.50" W x 0.42" H
LED-39686	Flexible LED Light Bar	9 LED	Blue	10.34" L x 1.50" W x 0.42" H
LED-39687	Flexible LED Light Bar	12 LED	White	12.93" L x 1.50" W x 0.42" H
LED-39688	Flexible LED Light Bar	12 LED	Blue	12.93" L x 1.50" W x 0.42" H

## LED Module Pod Light Strings

- Completely Waterproof LED Modules
- Three (3) Super Bright LEDs Per Pod
- Available in Single Modules or Long Strings
- Great for "Rope Light" Applications or Any General Courtesy Lighting
- Available in Multiple Colors



Part #	Description	Color
LED-59265	Pod Light Strings - 20' light string	White
LED-59266	Pod Light Strings - 20' light string	Blue
LED-59267	Pod Light Strings - 20' light string	Green
LED-59268	Pod Light Strings - 20' light string	Red

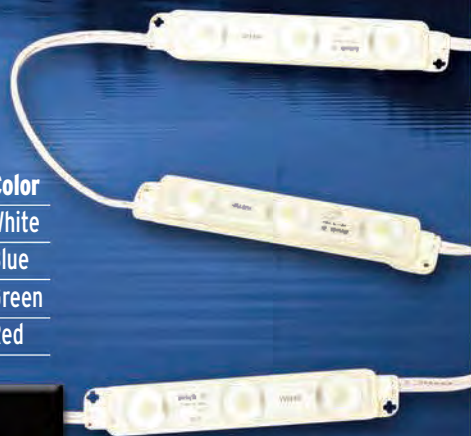

LED LIGHTING





# COURTESY LED LIGHTS



## Stainless LED Puck Lights

**Clean Looking - Excellent Brilliance**

Highly polished stainless steel housing offers a rich, clean look. Ideal for use in boats and RVs as a ceiling, courtesy or task light. Clear Polycarbonate engineered lens optics provides uniform and wide angle illumination.

- Great for Lighting under Cabinets, Cockpits, Headliners and Compartments
- Polished Stainless Steel Bezel
- Surface Mounts on any Flat Surface
- Hidden Fasteners
- Circuit Board Completely Sealed in Epoxy to Resist Water, Corrosion and Vibration
- LEDs Feature Super Long Life Span of up to 50,000 Hours
- 3" and 4" Diameter Sizes Fit Most Needs
- LED Colors Available: White, Blue and Red (3" only)

LED-51827 Puck Light  
3" Dia - 4 Warm White LEDs

LED-51828 Puck Light  
3" Dia - 4 Blue LEDs

LED-51897 Puck Light  
3" Dia. - 4 Red LEDs

LED-51831 Puck Light  
4" Dia - 6 Warm White LEDs

LED-51832 Puck Light  
4" Dia - 6 Blue LEDs



## Recessed LED Puck Lights

**Low Profile LED Lights - Smooth Look**

Ideal for cabin and compartment lighting in boats and RVs. Three bezel colors offer a shiny look and the clear PC lens, with engineered optics, provides uniform and comfortable illumination.

- Great for Under Cabinets, Rod Lockers, Utility Bins, Etc
- Recessed Mounting Gives Clean Profile Look
- Circuit Board Completely Sealed in Epoxy to Resist Water, Corrosion and Vibration
- Low Amp Draw for Longer Battery Life
- Hidden Fasteners
- 3" Diameter - 6 Brite LEDs
- Requires 2" Diameter Hole
- Black, White & Chrome Bezels Come with Each Light
- LED Colors Available: White, Blue, and Red

LED-51847 Recessed 3" LED Puck Flood  
3-Bezels - 6 White LEDs

LED-51848 Recessed 3" LED Puck Flood  
3-Bezels - 6 Red LEDs

LED-51849 Recessed 3" LED Puck Flood  
3-Bezels - 6 Blue LEDs



## LED Surface Mount Dome Light

**Easy Mount LED Dome Light with Switch**

Clear PC Lens pattern is uniquely designed to distribute the illumination to a wide beam angle of no less than 120°.

- Surface Mount - Easy Installation
- Ideal for Interior Use in Boats, RVs and Other Applications
- Circuit Board Completely Sealed in Epoxy to Resist Water, Corrosion and Vibration
- UV Stable White Housing Resists Color Fading
- Low Power Draw
- Hidden Fasteners
- On/Off Rocker Switch on Bezel
- Super Flux (P4) Type LEDs, Super Bright, Long Life Span up to 100,000 Hours
- Two Models: 15 White LEDs or 9 White / 6 Red LEDs (for night vision)
- Red/White Combo Model has 6 Red and 9 White LEDs

LED-51829 Dome Light w/Switch  
4" Dia  
15 Cool White LEDs

LED-51830 Dome Light w/Switch  
4" Dia  
6 Red / 9 White LED Combination



## Automatic LED Lid Light

- Automatic On/Off LED Light when Lid is Raised or Lowered
- Hands Free Operation - No Switch Needed
- Stainless Steel Ball Switch - Won't Rust or Corrode
- Shines Light Downward - Not into Eyes
- Six Bright White LEDs Illuminates Compartments Fully
- PATENT PENDING

LED-39540 Automatic LED Lid Light - White





# COURTESY LED LIGHTS



## Push-In LED Utility Light

- Great for Lighting Any Small Area
- Simple Push-In Installation
- 1-1/8" Diameter – Fits into a 3/4" Hole
- Stainless Steel Bezel

LED-51977 Push-In LED Utility Light - White

LED-51978 Push-In LED Utility Light - Blue

## Mini LED Dual Mount Courtesy Light

*All Purpose Dual Mount LED Courtesy Lights Mount Anywhere Light is Needed*

These mini utility lights use three LEDs to accent the cabin with soft light. They mount vertically or horizontally for low-profile placement on steps, companionways, under cabinets, compartments and more. Low heat, low amp draw, noncorrosive, shock-resistant and water-resistant.

- Can be Mounted to Face Down, Up or Out
- 3 Bright LEDs
- Very Low Amp Draw
- Versatile Use Anywhere Light is Needed
- Fixture Dimensions: 2-1/8" L x 5/8" H x 1/2" W
- Stainless Steel Fasteners Included



LED-51880 Mini LED Light Dual Mount 3 White LEDs

LED-51898 Mini LED Light Dual Mount 3 Blue LEDs

## LED Push-In Cockpit Light

- No Fasteners Required for Installation
- Low Profile and Watertight
- Versatile LED Light for Varying Application
- LED Color - White RGB (69500-RGB)
- Lumens: 2.58, Color: N/A
- Cutout: 3/4" Standard Button Light
- Wattage: RGB: 0.6W
- Voltage: 12V
- Amp Draw: RGB: 0.05 A



**NEW!!**

LED-1404 LED Push-In Cockpit Light

## Livewell/Courtesy Lights LED

- Totally Waterproof
- Neoprene Sealing Gasket Included
- Can Mount Underwater
- Bright 3-Element LED Bulb

Part #	Description	Color	Hole Size	OD
LWL-1P-LED	Livewell/Courtesy Light - LED - Potted		1"	1-7/8"
LWLM-1P-LED	Mini Livewell/Courtesy Light - LED - Potted	White	5/8"	1"
LWLM-1P-LED-BLUE	Mini Livewell/Courtesy Light - LED - Potted	Blue	5/8"	1"



LWLM-1P-LED

## Flush Head LED Livewell Lights

*Totally Waterproof Light Can be Mounted Underwater*

Also great for accent and courtesy lighting! Waterproof, super bright LED designed for livewells, lockers or compartments. Can be used above or below water level with through wall mounting. Also great for accent lighting.

- Great for Livewell Illumination – 100% Waterproof
- Light up High Moisture Areas Without Worry
- Compact Size Mounts Anywhere
- Low Amp Draw for Longer Battery Life
- Super Life Span up to 100,000 Hours
- Impact Resistant Lens with Wide Viewing Angle
- Requires 1" Hole
- 1 LED with Diffuser Lens
- Low Power Draw - Miniscule Heat
- Pigtail Connection, 12V
- Diameter – 1-1/4"



LED-51874 Livewell / Utility Light White LED

LED-51875 Livewell / Utility Light Blue LED





# COURTESY LED LIGHTS

## LED Companion Way Lights

*Light Pathways, Steps and Utility Boxes Economically*

- Opaque PC Lens Produces Warm Glow
- Circuit Board Completely Sealed in Epoxy to Resist Water, Corrosion and Vibration
- Low Current Draw, Super Long Life Span up to 100,000 Hours
- Easy Surface Mount • Fasteners Included
- Bezel Colors Available: Black, White, Chrome Plated
- Dimensions: 2.6" Long x 1.3" Wide

LED-51816	Companion Way LED Light	Black Plastic Bezel	2 White LEDs
LED-51819	Companion Way LED Light	White Plastic Bezel	2 White LEDs
LED-51818	Companion Way LED Light	White Plastic Bezel	2 Red LEDs
LED-51822	Companion Way LED Light	Chrome Bezel	2 White LEDs
LED-51820	Companion Way LED Light	Chrome Bezel	2 Blue LEDs



## LED Oval Courtesy Lights

- Built In Switch – Push Lens for “On/Off”
- 12 Volt – 5 Watt – Tin Wire • Oval Hole – 3-1/4" x 2-1/8"
- Flange Overall – 5" x 3-1/8"

Light	Mounting Ring	Description
LED-OCL-1	OCLR-1	Oval Courtesy Light - Black
LED-OCL-2	OCLR-2	Oval Courtesy Light - White
LED-OCL-1K-DP		Black Packaged - Light & Ring
LED-OCL-2K-DP		White Packaged - Light & Ring
OCL-1	OCLR-1	Incandescent Oval Courtesy - Black
OCL-2	OCLR-2	Incandescent Oval Courtesy - White



## LED Courtesy Companion Way Lights

*Recessed Courtesy Companion Way Lights Provide Light In a Variety of Uses*

- LED Square Courtesy Light / Companion Way Light – 2.25" x 2.25"
- Great for Compartments, Rod Lockers, Gear Bins, etc.
- Lights a Pathway or Storage Area
- LEDs – Low Power – Long Life (up to 100,000 hours)
- Frosted PC lens • 3 LEDs Provide Excellent Illumination
- Circuit Board Completely Sealed in Epoxy to Resist Water, Corrosion/Vibration
- Available Bezel Colors: Black and White
- Hidden Fastener Models Provide Clean, No Screw-head Exposed Installation

LED-51894	Courtesy Companion Way LED Light	White Plastic Bezel - 3 White LEDs - hidden fasteners
LED-51891	Courtesy Companion Way LED Light	Black Plastic Bezel - 3 White LEDs - hidden fasteners
LED-51899	Courtesy Companion Way LED Light	Sand Plastic Bezel - 3 White LEDs - hidden fasteners
LED-51876	Courtesy Companion Way LED Light	White Plastic Bezel - 3 White LEDs - exposed fasteners
LED-39050	Courtesy Companion Way LED Light	Black Plastic Bezel - 3 White LEDs - exposed fasteners





# COURTESY LED LIGHTS

## LED Mini Accent Light

- Versatile Accent LED Light
- Two Bright LED's
- Hidden Fasteners
- 316 Stainless Steel Bezel
- Small Flush Mounted Light Great for Stairs, Doors, Compartments

### Mini Accent LED Light - Combo Colors

- Two Colors in a Small and Very Attractive Package
- Light is Switched so that it can be Turned to White or to Alternate Color.
- Red or Blue are Alternate Colors Available
- Great for T-Tops and Anywhere that Night Vision Could be Needed



Part #	Description	LED Color
LED-39116	LED Mini Accent Light - Red/White Combo - 4 Diode	Red/White Combo
LED-39117	LED Mini Accent Light - Blue/White Combo - 4 Diode	Blue/White Combo
LED-39216	LED Mini Accent Light - 2 High Output LED - 316 SS Bezel	White
LED-39217	LED Mini Accent Light - 2 High Output LED - 316 SS Bezel	Blue
LED-39218	LED Mini Accent Light - 2 High Output LED - 316 SS Bezel	Red
LED-39224	LED Mini Accent Light - 2 High Output LED - No Bezel	White
LED-39254	LED Mini Accent Light - 2 High Output LED - Black SS Bezel	White
LED-39255	LED Mini Accent Light - 2 High Output LED - Black SS Bezel	Blue

## Courtesy/Accent LED Light

- Attractive Chrome Bezel
- 1-3/4" W x 3" L - Fits Anywhere
- Great for Hatches, Storage, Compartment, Etc.
- Two Super Bright LEDs
- Illuminate Entries & Steps

Part #	Description	LED Color	Bezel
LED-39024	Courtesy/Accent LED Light	White LEDs	Chrome
LED-39027	Courtesy/Accent LED Light	White LEDs	Black
LED-39034	Courtesy/Accent LED Light	Blue LEDs	Chrome



## LED Oblong Courtesy Lights

### Provides Attractive Light Anywhere

Attractive stainless steel bezel courtesy lights can be used virtually anywhere. The bright polished stainless provides a very rich look. They are great for accent lighting, step, task, compartment, cabinet or courtesy lighting.

- Surface Mount
- Hidden Fasteners
- Three Bright LEDs Provide Excellent Brilliance
- Engineered Lens Directs Light Downward to Avoid Light from Shining into the Eyes
- Circuit Board Completely Sealed in Epoxy to Resist Water, Corrosion and Vibration
- Super Long Life LEDs - Up to 100,000 Hours
- Polished 316 Stainless Steel Bezel
- 1.25" W x 3" L
- Available LED Colors: White, Red and Blue

LED-51823	Oblong Courtesy Light	3 Blue LEDs
LED-51824	Oblong Courtesy Light	3 Red LEDs
LED-51825	Oblong Courtesy Light	3 White LEDs



# COURTESY LED LIGHTS



## Slim Line LED Utility Strip Lights

*Long Lasting Strip Light is a Multi Purpose Solution*

Excellent for lighting or decorating interior and exterior of boats, RVs and other vehicles.

- Submersible - 100% Waterproof - Can be Used Virtually Anywhere
- Surface Mounting for Easy Installation
- Low Amp Draw For Longer Battery Life
- Clear Lens Provides Maximum Light

LED-51800	Slim Line Strip Light	4"	6 White LEDs
LED-51801	Slim Line Strip Light	4"	6 Blue LEDs
LED-51803	Slim Line Strip Light	4"	6 Red LEDs
LED-51805	Slim Line Strip Light	6"	12 White LEDs
LED-51806	Slim Line Strip Light	6"	12 Blue LEDs
LED-51810	Slim Line Strip Light	8"	18 White LEDs
LED-51811	Slim Line Strip Light	8"	18 Blue LEDs

- Three Lengths (4", 6", and 8") Cover Any Application
- 4" LED colors available: White, Blue, and Red
- 6" LED colors available: White, Blue
- 8" LED colors available: White, Blue



## LED Rail Light

*Rotating LED Rail Light*

This series of the lights features a rotating axis design to adjust the light to any desired direction.

- Circuit Board Coated with Conformal Coating to Resist Moisture, Corrosion and Vibration
- Powder Coated Aluminum Extrusion Rail with Molded Mounting Ends
- Light Rotates to Direct Light Where You Want It
- Frosted Lens Pattern for Uniform Light Distribution
- Super Bright, Efficient, Long Lasting LEDs (up to 100,000 hours)
- Low Power Draw • Surface Mount • Easy to Install Anywhere
- Available in 6" (12 LED) and 12" (24 LED)

LED-51857	LED Rail Light w/Switch 6" L - 12 Cool White LEDs	Rotating
LED-51858	LED Rail Light w/Switch 12" L - 24 Cool White LEDs	Rotating



## Mini Stick-On LED Light

- Peel & Stick Anywhere You Need Light
- Small Unobtrusive Light Fits Anywhere
- Single Bright LED • 7/8" Diameter

LED-39072 Mini Stick-On Light - White

LED-39073 Mini Stick-On Light - Blue



See more T-H Marine products and accessories at [www.thmarine.com](http://www.thmarine.com)



# COURTESY LED LIGHTS

## LED Round Companion Way with Eyebrow Accent Slit

- Luxury Style Courtesy Light
- Low Profile
- Chrome Cover with Accent Slit
- Provides Ambient Lighting Above and Directed Lighting Below
- Waterproof
- Available in White and Blue

Part #	Description	LED Color
LED-39100	LED Round Companion Way with Eyebrow Accent Slit	White
LED-39101	LED Round Companion Way with Eyebrow Accent Slit	Blue



## LED Module Courtesy Lights

Our LED Modules offer a powerful punch in a small package. LED Module courtesy lights are superb for many marine environment uses. LED modules are the most economical choice for courtesy, utility, or task lighting. These modules are injection molded, polymer encased LED lights that are super durable. Modules are waterproof, so they can be used virtually everywhere in your boat, on your trailer, etc. All of our

Module lights include the following features:

- Most economical courtesy lights available
- IP68 - Fully waterproof and submersible
- Super durable and long life (50,000+ hours)
- Simple installation: Mount with adhesive strips or fasteners
- Low power: @12V DC, 0.2 Watts / 0.017 Amps per LED
- Super bright in multiple colors

### SINGLE LED Module Light

Contains: One (1) LED  
 Dimensions: 1.56" L x 1.11" W x 0.34" H  
 Colors: White, Blue



Part #	Description	LED Color
LED-34189	LED Module Light, Single - 1 LED Module	White
LED-34190	LED Module Light, Single - 1 LED Module	Blue

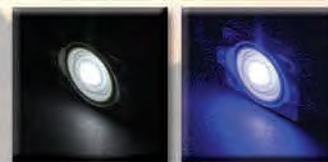

### TRIPLE LED Module Light

Contains: Three (3) LEDs  
 Dimensions: 3.21" L x 0.52" W x 0.42" H  
 Colors: White, Blue, Green, Red



Part #	Description	LED Color
LED-34180	LED Module Light, Triple - 3 LED Module	White
LED-34181	LED Module Light, Triple - 3 LED Module	Blue
LED-34182	LED Module Light, Triple - 3 LED Module	Green
LED-34183	LED Module Light, Triple - 3 LED Module	Red



### QUAD LED Module Light

Contains: Four (4) LEDs  
 Dimensions: 1.90" L x 1.50" W x 0.42" H  
 Colors: White, Blue, Green, Red



Part #	Description	LED Color
LED-34185	LED Module Light, Quad - 4 LED Module	White
LED-34186	LED Module Light, Quad - 4 LED Module	Blue
LED-34187	LED Module Light, Quad - 4 LED Module	Green
LED-34188	LED Module Light, Quad - 4 LED Module	Red





# COURTESY LED LIGHTS



**NEW!!**

## Stainless Steel Indirect LED Courtesy Light

These indirect courtesy lights / accent lights are attractive, compact, and very bright. They are fully water sealed and IP67 compliant and ideal for either interior or exterior indirect lighting applications. Available in three color output options with polished 316 stainless steel finish.

- Lumens (White): 50
- Voltage: 10-15v DC
- 12v DC Amps: 45 mA
- Rated Watts: 0.55
- Mounting Hole Diameter: 5/16"
- Dimensions: 1" W x 1" H x 1/2" D
- Ingress Rating: IP67
- Light Body Material: Stainless Steel
- LED Colors: Blue, Red, White & RGB



LED-33240	Indirect Stainless Steel LED Courtesy Light	White
LED-33241	Indirect Stainless Steel LED Courtesy Light	Blue
LED-33242	Indirect Stainless Steel LED Courtesy Light	Red
LED-32648	Indirect Stainless Steel LED Courtesy Light	RGB

## Low Profile Stainless Steel LED Dome Light

**NEW!!**

This low profile stainless steel dome light is a beautiful polished stainless steel light that surface mounts. Available in three LED combinations: all white, blue/white combination, and red/white combination. Perfect for any dome light application.

- Lumens (White): 250
- Voltage: 10-30 Vdc
- 12v DC Amps: 410 mA
- Rated Watts: 6
- Mounting Hole Diameter: 3/4"
- Dimensions: 6.75" dia. x 1.13"
- Ingress Rating: IP67
- Light Body Material: Stainless Steel
- LED Colors: White, White/Blue, White/Red



LED-33249	Low Profile Dome LED Light, Stainless Steel Bezel	White
LED-33250	Low Profile Dome LED Light, Stainless Steel Bezel	Blue/White Combo
LED-33251	Low Profile Dome LED Light, Stainless Steel Bezel	Red/White Combo

## High Intensity Oval LED Courtesy Light/Rock Light

**NEW!!**



This high intensity oval LED courtesy light is seriously bright, yet small in size. Light body is black or white power coated aluminum for the harshest elements. Available LED colors are blue and white. This light is great as a deck light, task light, or courtesy light for your boat. This light is also designed to withstand the rigors of trailer lighting, to add color and style to your boat trailer. LED Lifespan of 50,000+ and low amp draw.



- Durable Glass Lens
- Billet Aluminum Housing
- Powder Coat Finish – Black or White
- LED Colors – White, Blue, Red, Green, Amber & RGB
- Watts: 3W
- Amp Draw: 0.2 A
- Quantity of LEDs: 3
- Raw Lumens: 200
- Dimensions: 3" W x 1.625" H

LED-33253	High Intensity Oval Courtesy LED Light - White Housing - Blue
LED-33255	High Intensity Oval Courtesy LED Light - Black Housing - White
LED-33256	High Intensity Oval Courtesy LED Light - Black Housing - Blue
LED-33257	High Intensity Oval Courtesy LED Light - Black Housing - Red
LED-33308	High Intensity Oval Courtesy LED Light - Black Housing - Green
LED-33309	High Intensity Oval Courtesy LED Light - Black Housing - Amber
LED-32650	High Intensity Oval Courtesy LED Light - Black Housing - RGB
LED-32651	High Intensity Oval Courtesy LED Light - White Housing - RGB





# BATTERY-OPERATED LED

## LED Flex Strip Lights – Battery Operated

- All the Features of T-H Marine 12V LED Flex Strip lights in a Convenient Battery Operated Version
- Allows for Lighting where Running Electrical Wiring is Difficult
- Waterproof Battery Box
- Uses Three (3) AA Batteries
- 18" Strips Available in Three Colors – White, Blue, Green

Part #	Description	Length	Color
LED-39275	LED Flex Strip Light, Battery Operated	18"	White
LED-39276	LED Flex Strip Light, Battery Operated	18"	Blue
LED-39277	LED Flex Strip Light, Battery Operated	18"	Green



## Battery Operated LED Slim Line Lights

- Same Great Features as Our Standard 4" LED Slim Line Lights
- Now in Battery Operated Version for Hard to Wire Places
- Waterproof Battery Box
- Uses Three (3) AA Batteries, Included
- Available Colors: White, Blue

Part #	Description
LED-39670-DP	Battery Operated 4" LED Slim Line Light, Packaged, White
LED-39672-DP	Battery Operated 4" LED Slim Line Light, Packaged, Blue



## Battery Operated LED Strip Light Accent Kit Pairs

- Same Great Features as Our Standard LED Flex Strip Lights
- Convenient Battery Operated Version
- Includes Two (2) LED Strips, 18" Long
- Includes Mounting Track, Mounting Track Ends, Fasteners
- Waterproof Battery Box
- Uses Three (3) AA Batteries, Included
- Available Colors: White, Blue, Green

Part #	Description
LED-39308-DP	Battery Operated 2x18" LED Strip Accent Kit, Packaged, White
LED-39310-DP	Battery Operated 2x18" LED Strip Accent Kit, Packaged, Blue
LED-39312-DP	Battery Operated 2x18" LED Strip Accent Kit, Packaged, Green

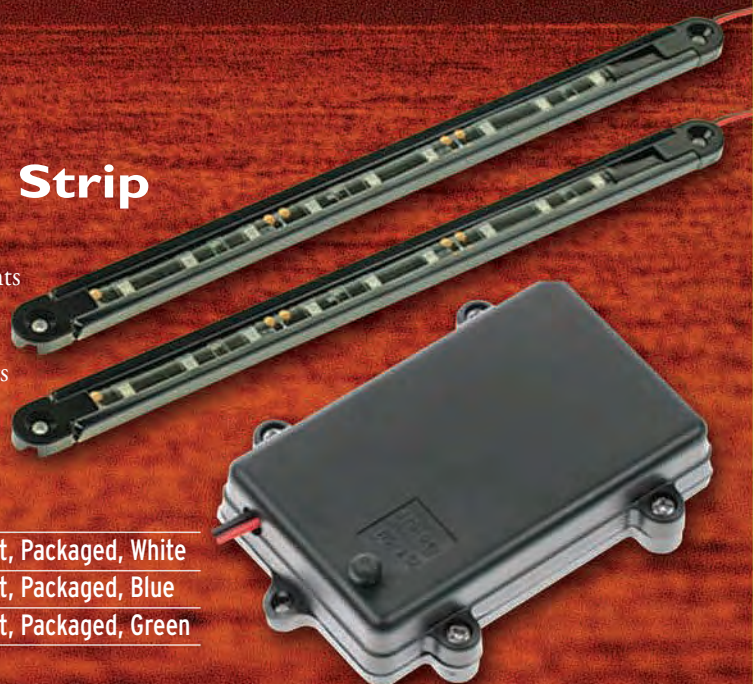

LED LIGHTING



# LED CUPS & SPEAKERS

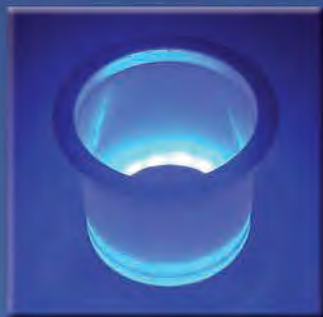

## LED Lighted Stainless Steel Rim Drink Holder

- Illuminated Cup Holder Provides Soft LED Lighting
- 15 Super Bright LEDs in Blue, Green, Red or White
- Robust UV Stable Molded Housing
- Mounts in Standard 3-5/8" Hole
- Corrosion Resistant 316 Stainless Steel Rim for a Sleek Finished Look
- LED Light System is Waterproof
- Includes Drain Hole and Nipple for Routing Drainage
- Wired for Connection to 12V Source

Part #	Description	LED Color
LED-LCH-BU	LED Lighted Drink Holder w/SS Rim	Blue
LED-LCH-G	LED Lighted Drink Holder w/SS Rim	Green
LED-LCH-R	LED Lighted Drink Holder w/SS Rim	Red
LED-LCH-W	LED Lighted Drink Holder w/SS Rim	White

## Cup Holder LED Accent Ring

- Convert Any Cup Holder to LED Accent
- Simple Installation – Fits Under Cup Holder Top Flange
- Fits Cup Holders from 3-1/4" to 3-1/2" Dia
- Ring Contains 18 Attractive LEDs

**NEW!!**

LED-SMCHR-B	Cup Holder LED Accent Ring	18 Blue LEDs
LED-SMCHR-R	Cup Holder LED Accent Ring	18 Red LEDs
LED-SMCHR-G	Cup Holder LED Accent Ring	18 Green LEDs

## LED Cup Holder Insert

- UV-Enhanced Foam Insulator
- Rubber Tabs Secure Cans and Bottles
- Made from Polymer Material and Acrylics
- Easily Removable for Clean up
- Snug, Secure Fit Eliminates Rattle when in Motion

**NEW!!**

Part #	Description	LED Color
LED-CHI-W	Cup Holder Insert, LED	White
LED-CHI-B	Cup Holder Insert, LED	Blue
LED-CHI-R	Cup Holder Insert, LED	Red
LED-CHI-G	Cup Holder Insert, LED	Green
LED-CHI-RGB	Cup Holder Insert, LED	RGB



## Speaker LED Accent Ring

- Light Up Your Boat Speakers
- Lights Up Speaker Enclosure or Bezel
- Fits Behind Speaker – Easy Installation
- Ring Contains 30 Attractive LEDs

**NEW!!**

Diameter	Blue	Red	Green
5"	LED-SMSKR-5B	LED-SMSKR-5R	LED-SMSKR-5G
6-1/2"	LED-SMSKR-B	LED-SMSKR-R	LED-SMSKR-G





# Z-LAUNCH™ Watercraft Launch Cord

Makes launching boat by yourself as easy as 1-2-3! Endorsed and used by professional angler Timmy Horton...used by majority of BASS and FLW fishing professionals.

The patented Z-LAUNCH™ Watercraft Launch Cord makes solo watercraft launching easier than you've ever experienced.

The no-hassle launch cord, made of premium elastics, uses automatically adjusting tension when you back your boat, jet ski, or tow tube into the water, so it won't jerk your watercraft around when you pull the trailer forward. Expandable to more than 2x original length, the Z-LAUNCH™ Watercraft Launch Cord attaches in just 3 steps. Fasten a hook to your trailer, connect a steel ring to the winch, and lock the winch. You're ready for the smoothest watercraft launching on the water.



*Tim Horton,  
Professional Angler*



- All Stainless Hardware
- Simple and Safe Operation
- No-Hassle Design
- Attaches Easily
- Expands to More than 2x Length
- Unlike Rope, will not Jerk Your Watercraft or You
- Stay Safe and Dry Launching Your Boat Alone
- Great for Ramps with "No Power" Laws



Part #	Description	Length	Boat Type
ZL-10-DP	Z-LAUNCH™	10'	Boats to 16'
ZL-15-DP	Z-LAUNCH™	15'	Boats to 17' to 22'
ZL-20-DP	Z-LAUNCH™	20'	Boats 23' to 35'



Visit [thmarine.com](http://thmarine.com)  
for more products  
and information!



# YOLOtek

Powering Your Adventures!



T-H MARINE is your exclusive source for YOLOtek products.

YOLOtek is an exciting brand of products designed to improve the powering and usage of mobile phones and action cameras on boats and in other active lifestyle spaces.

T-H MARINE holds the exclusive worldwide license for YOLOtek products in the following markets: recreational boating, recreational fishing, recreational vehicles and sporting goods.

YOLOtek is the "Official Powered Mount Provider" for Major League Fishing (MLF) and the FLW Tour.



BOATING AND MARINE ACCESSORIES



AWARDED -  
Best New Product  
Showcase Winner  
at 2015 American  
Sportfishing  
Association ICAST  
Show.



## YOLOtek - PowerStick™

Navigation Light Base Powered & Mounted Cell Phone Holder and USB Charger

Patent Pending

PowerStick provides power thru TWO (2) USB power ports and HOLDS your phone securely. Plugs into the navigation light port on the front or back of your boat. Provides the power you need for phone, camera, and all your electronic gear! Power where you want it, right on your boat.

IPX6 Waterproof USB: 2.1 fast charging on top and standard 1.0 on bottom. Dead cell phones on your boat are a thing of the past. Power Up with PowerStick!

**Part # Description**

YO-PSV1 YOLOtek PowerStick™ - Nav Light Base Powered Cell Phone Holder & USB Charger





*AWARDED -  
Selected as a  
TOP NEW  
PRODUCT  
at the 2015  
BASSMASTER  
Classic Show.*

**YOLOtek**  
Powering Your Adventures!

**NEW!!**

## YOLOtek - AquaStickPOWER™

*Navigation Light Base Powered & Mounted Action Camera Extension Mounting Stick*

*Patent Pending*

AquaStickPOWER (USBx2) is what the pros use to hold & power their GoPro, VIRB, iON or other action cameras. Plugs right into your navigation light ports on your boat. Securely mounts your action camera with a locking collar for speeds up to 70 mph.

TWO (2) USB power ports means you NEVER worry about the battery of your action camera again. IPX6 Waterproof USB: 2.1 fast charging on top and standard 1.0 on bottom. Extends from approximately 29" to 43". Provides secure mounting and great point of views for camera. Capture all those special moments on your boat without needing a person to hold the camera. Don't miss the shot with AquaStickPOWER! GoPro case not included.

*Official Powered Mount Provider for Major League Fishing (MLF) and the FLW Tour.*

Part #	Description
YO-ASPV1	YOLOtek AquaStickPOWER™ - Nav Light Base Powered Action Camera Extension Mounting Stick



BOATING AND MARINE ACCESSORIES

## YOLOtek - AquaStick™

*Navigation Light Base Mounted Action Camera Extension Mounting Stick (non-powered)*

*Patent Pending*

AquaStick mounts your GoPro, VIRB, iON, or other action camera in your navigation light port. Secures with a locking collar for running at speeds up to 70 mph.

This non-powered version of the AquaStick provides a superb mounting stick. Extends from approximately 29" to 43". Provides secure mounting and great point of views for camera. Capture all those special moments on your boat without needing a person to hold the camera. Don't miss the shot with AquaStick! GoPro case not included.

Part #	Description
YO-ASV1	YOLOtek AquaStick™ - Action Camera Extension Mounting Stick, Non-Powered (Without USB Ports)





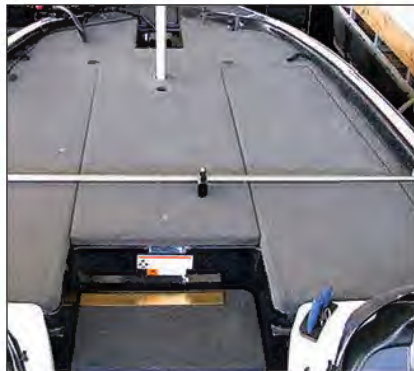

## Loc-R-Bar™ Boat Security System

- Stong Adjustable Stainless Steel Bar Prevents Theft
- Total Protection for Less Than a Quality Rod & Reel
- Locks Rod Locker Boxes Securely
- Unique Alarm Padlock Alerts for Intruders
- Optional Adapter Secures Front Boxes



Loc-R-Bar™ Front Compartment Adapter

Part #	Description
LB-LRBS113S	Loc-R-Bar™ Complete Alarm System
LB-LCK110DBA	Loc-R-Bar™ Alarm Padlock Only
LB-ADAPTER/1A	Loc-R-Bar™ Front Compartment Adapter
LB-SET-BKS-03A-03B	Set of L-R Mounting Brackets



## Banshee™ Alarm Padlock

- Great for Trailer Couplers, Gear Boxes, Rod Lockers, etc.
- Fits Most Trailer Couplers
- Screams like a Banshee when Activated
- Vibration Activated Alarm Increases in Volume
- Can be De-activated for Trailing



Part #	Description
LB-TLRLCK	Banshee™ Alarm Padlock

### 2 Sided Mounting Pad Antenna



Main Engine

Wiring for Optional Installation

## Two Way Boat Alarm

- Shock Sensor Detects Intruders
- Alerts you up to 3000 Yards when Activated
- Two Way Remote Alerts with Sound, Light & Vibration
- Up to 3000 Yards Response and 1000 Yards Transmit
- 128 db Alarm Horn
- Waterproof Main Engine
- Shock Sensor with Sensitivity Adjustment
- Easy Installation



Endorsed by Kevin Van Dam



Siren

Remote

Part #	Description
TWA-1-DP	Two Way Alarm System - Complete Set
TWAR-1-DP	Two Way Alarm - Additional Remote Control Unit
TWA-DIS-5	Counter Display with 5 Alarm Kits

## Light Clips

- Secure and Stow Navigation Lights
- Fits All Standard 7/8" Navigation Light Poles



Part #	Description
RUSC-1	Rubber Light Clips - Black

## Light Mounting Bracket

- Brackets Mount the Light Directly to the Rub Rail or Gunnel of Boat
- Kit Contains Two Mounting Brackets and Hardware for Mounting to Boat
- Fits LED Mini Spreader (page 51)

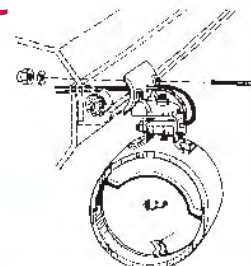

Part #	Description
HLB-1-DP	Light Mounting Bracket

## Quick Flush™ — Outboard Flush Kits

- Snaps On – Quickly Flushes Salt or Sand from Outboard
- Slide Valve Stays on Engine Permanently – “O” Ring Sealed
- No More Fighting Garden Hose to Connect to Engine
- Kit Contains: Slide Valve – Quick Connect – Rubber Washer
- Fits All Outboards with Flushing Port

Part #	Item	Application
QF-1K-DP	Complete Kit	Johnson - Evinrude*
QF-2K-DP	Complete Kit	Merc/Yamaha/Other

\*Inspection Stream Hole in Valve



Patented 5,671,906



## Steer-Stop™ Steering Lock

- Locks Hydraulic Steering when Trailing
- Clips onto Hydraulic Steering Rams
- Keeps Engine Straight and Prevents Damage to Transom Savers

Part #	Description
SS-1-DP	Steer-Stop™ Steering Lock Set - 4"

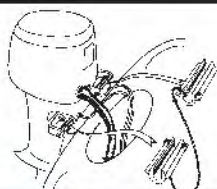

## Motor Stik™

- Fits Over Trim Rams
- Supports Your Outboard While Trailing
- Takes the Pressure Off of Hydraulic System
- Most Outboards 150hp and Up
- Strong Aluminum Tubing with Molded Ends
- Salt or Fresh Water

Part #	Description
MSS-1	Outboard Motor Supports



Outboard Motor Support

## Evinrude G2 Motor Support

- Constructed from Extra Tough Aluminum and Delrin Composite
- Protects Evinrude G2 Motor and Boat Transom while Trailing
- Protects Boat Steering System and Releases Pressure on Engine Hydraulic System
- Total Length: 18" • Base Width: 12"
- Width: 7.5" (from Enter Points of Prongs)

Part #	Description
MS-EG2-DP	Evinrude G2 Motor Support



## Trailing Clips

- Protects Stern Drive Units while Trailing or Storing
- Increase the Life of the O-Rings, Internal Seals, and Valve in the Hydraulic System
- Resistant to UV Rays, Gasoline, Oil and Other Marine Chemicals
- Fits all Stern Drives with 3/4" Hydraulic Rams

Part #	Description
TC-1-DP	Trailing Clips, Pair - 12" Length

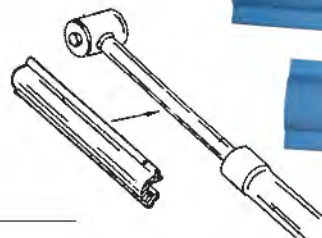





## Folding Drink Holder

- Pop-up Adjustable Arms Fit Mugs, Cans, Bottles and Insulated Coolies
- Corrosion-Free Construction
- Folds Away When Not in Use
- Opening Measures 3.75" Across
- Stainless Steel Mounting Hardware Included

Part #	Description	Color
LCH-52012	Folding Cup Holder	White
LCH-52016	Folding Drink Holder	Black



## Cup Holder

- Resistant to UV, Breakage and Chemicals
- Short Cup Holder has Drain Holes on Bottom
- Large Cup Holder Accepts 3/8" I.D. Hose for Drainage

Black #	White #	A	B	C
LCH-1	LCH-1W	4-1/4"	4-5/16"	4-1/4"
LCH-2		1-7/8"	4-3/16"	3-5/8"

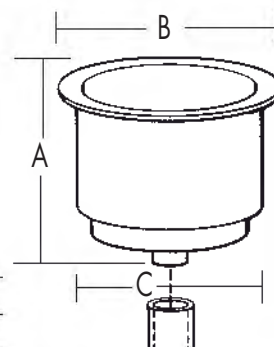

## Stainless Steel Cup Holder

- Top Quality Stainless Steel – 304 Stainless Steel
- Requires 3-5/8" Hole – Fits Most Existing Cup Holes
- Drain Fits 3/8" Hose

Part #	Description	A	B	C
LCH-1SS	Stainless Steel Cup Holder	4"	4-1/8"	3-5/8"

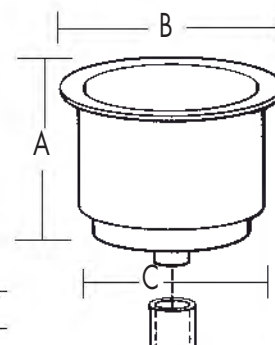

## LED Cup Holder Insert

- UV-Enhanced Foam Insulator
- Rubber Tabs Secure Cans and Bottles
- Made from Polymer Material and Acrylics
- Easily Removable for Clean up
- Snug, Secure Fit Eliminates Rattle when in Motion



Part #	Description	LED Color
LED-CHI-W	Cup Holder Insert, LED	White
LED-CHI-B	Cup Holder Insert, LED	Blue
LED-CHI-R	Cup Holder Insert, LED	Red
LED-CHI-G	Cup Holder Insert, LED	Green
LED-CHI-RGB	Cup Holder Insert, LED	RGB





## LED Lighted Stainless Steel Rim Drink Holders

- Illuminated Cup Holder Provides Soft LED Lighting
- 15 Super Bright LEDs in Blue, Green, Red or White
- Robust UV Stable Molded Housing
- Mounts in Standard 3-5/8" Hole
- Corrosion Resistant 316 Stainless Steel Rim for a Sleek Finished Look
- LED Light System is Waterproof
- Includes Drain Hole and Nipple for Routing Drainage
- Wired for Connection to 12V Source
- A = 4" Depth • B = 4-1/8" Rim Dia. • C = 3-5/8" Hole Cut



Part #	Description	LED Color
LED-LCH-BU	LED Lighted Drink Holder w/SS Rim	Blue
LED-LCH-G	LED Lighted Drink Holder w/SS Rim	Green
LED-LCH-R	LED Lighted Drink Holder w/SS Rim	Red
LED-LCH-W	LED Lighted Drink Holder w/SS Rim	White

## Molded Drink Holders with Stainless Steel Rim

- Available with Removable or Fixed Stainless Steel Rim
- Robust Plastic Drink Holder with Built-in Drainage Hole and Nipple
- Corrosion Resistant 316 Stainless Steel Rim for a Sleek Finished Look
- Installs in a Standard 3.625" Cutout
- Stepped Cup to Accommodate Various Drink Sizes
- A = 4" Depth • B = 4-1/8" Rim Dia. • C = 3-5/8" Hole Cut

Part #	Description
LCH-ISR	Molded Drink Holder with Fixed Stainless Steel Rim
LCH-ISRREM	Molded Drink Holder with Removable Stainless Steel Rim, Screw Mount



Fixed Stainless Steel Rim



Removable Stainless Steel Rim

## Premium Flexible Cup Holder Drink Stabilizer

- Soft and Flexible Molded Inserts Fit Snugly into Drink Holders to Stabilize Drinks of Different Sizes
- Prevent Rattling Sounds and Drink Spillage

Part #	Description	Fits
LCH-DKS-1	Cup Holder Drink Stabilizer	LED Lighted and Stainless Steel Rim Cup Holders
LCH-DKS-2	Cup Holder Drink Stabilizer	Complete Stainless Steel Cup Holders







## Fuel Container Hold-Down Kit

- Securely Holds Portable Fuel Tanks Up to 62" in Circumference
- Quick Release Buckles for Quick & Easy Removal
- Kits Includes: Two 62" Poly Straps, Four Footman Loops w/ Hardware

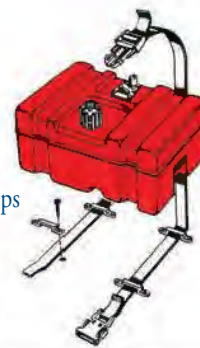

### Part # Description

FCH-1	Fuel Container Hold-Down Complete Kit
-------	---------------------------------------



## Cooler Mounting Kits

- Secures Any Size Cooler to Deck
- Recessed Fasteners Allow Full In-corner Mounting
- Nylon Bungee Straps – Stainless Steel Center Hook
- Kit Contains Four Corner Brackets and Two Bungee Straps

### Part # Description

CMK-1-DP	Complete Cooler Mounting Kit
----------	------------------------------

STRAP-12BWS	Single Cooler Mount Bungee Straps
-------------	-----------------------------------



## Suction Cup Lever Tie Down

- Spring Locking D Hook
- Quick Locking and Releasing Lever

### Part # Description

TD-54778	Suction Cup Lever Tie Down - 4 pack
----------	-------------------------------------



## All Purpose Holding Strap Kits

- Tough 62" Polypropylene Strap Secures Any Loose Article
- Quick Release Buckle Makes Removal a Snap
- Two Footman Loops and Stainless Hardware Included

### Part # Description

APS-1	All Purpose Holding Strap Kit w/Plastic Buckle & 2 Molded Footman Loops
-------	---

BSK-1SS	All Purpose Holding Strap Kit w/Stainless Steel Buckle & 2 Stainless Steel Footman Loops
---------	--

## Prop Stop™ Spare Prop Retainer

- Secures Spare Propeller in Any Location
- Holds Any Size Propeller and its Thrust Washers
- Tough Graphite Retaining Rod

### Part # Description

PRR-1	Prop Stop™ Rod Only
-------	---------------------

## Paddle Keeper

- Unique Concept for Paddle Storage
- Holds Paddle Either Vertical, Horizontal or Overhead

Part #	Description
PK-1-DP	Paddle Keeper



## Windshield Fastener

- Makes Installing and Removing the Windshield Simple
- Base Mounts to the Boat and the Quick Twist Fastener Passes Thru Windshield
- Great for Preventing Broken Windshields in Shipping, Installation and for Cleaning

Part #	Description
WSH-1	Windshield Fastener - Wing Nut Head
WSH-1F	Windshield Fastener - Flush Mount Slotted Head

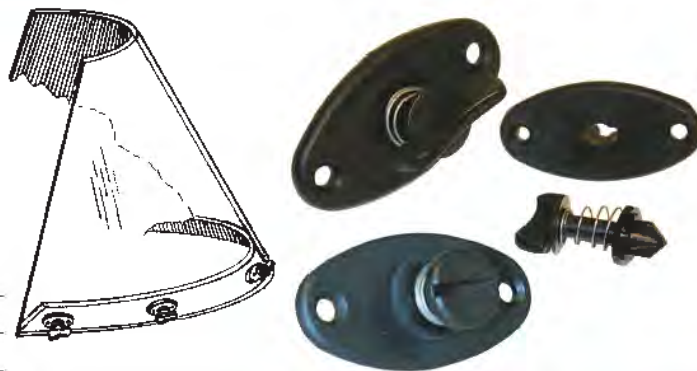

## Battery Holder Tray for Optima® Batteries

- Shaped Inserts Fit Both Optima® D27M and D31M Series
- Rugged Poly Tray with 8 Mounting Slots
- Poly Strap with Stainless Steel Buckle
- Resistant to UV and Corrosion

Part #	Description
NBH-31-SSC-OPT	Battery Tray for Optima® Batteries



## 24/27 Series Combo Battery Tray

- Holds Either 24 or 27 Series Deep Cycle Batteries – Removable Clips Allow Either Size to be Securely Held
- Rugged Poly Tray with 8 Mounting Slots
- Poly Strap with Stainless Steel Buckle
- Resistant to UV and Corrosion



Part #	Description
NBH-247P	24/27 Series Combo Battery Tray



## Battery Holder Replacement Straps

Part #	Description
BS-1	Replacement Battery Strap w/Poly Buckle
BS-1-42SS	Replacement Battery Strap w/Stainless Steel Buckle
BSK-1SS	Replacement Battery Strap w/Stainless Steel Buckle & 2 Stainless Steel Footman Loops







## Dual Battery Holder Tray

- Holds Two Series 27 Deep Cycle Batteries
- No Wasted Space – Two Batteries Side by Side
- Patented Poly Strap with Quick Release Buckle
- Meets All NMMA & ABYC Specs for Battery Retention

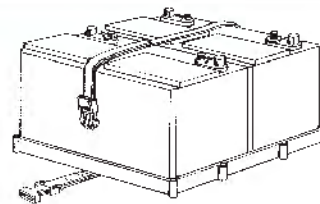

Part #	Description	Dimensions (OD)	Dimensions (ID)
DBH-27P	Dual Battery Holder - Plastic Buckle	14-1/2"	12-3/4"
DBH-27-SC	Dual Battery Holder - SS Buckle	14-1/2"	12-3/4"



## Battery Holder Tray with Stainless Steel Buckle

- Quality "316" Stainless Buckle
- Designed to Fit Tight Spaces
- Meets All NMMA & ABYC Specs
- Recessed Mounts – No Tabs

Stainless Buckle	Battery Series	Length (Inside)	Width (Inside)	Width (Outside)	Height
NBH-24-SSC	24	10-5/8"	7"	8"	1"
NBH-27-SSC	27	12-1/2"	7"	8-1/2"	1"
NBH-31-SSC	29/31	13"	7"	8-1/8"	1"
BS-1-42SS	Replacement Strap w/Stainless Steel Buckle				



## Frame Top Battery Tray

### Frame Top Holds Batteries Securely

- Top Frame Encompasses Entire Battery Perimeter
- Easy Adjust Knobs
- Thick Base Holds Heaviest Batteries
- Recessed Fasteners
- Available in Series 24, 27 and 31
- Stainless Steel Rods Resist Corrosion
- Meets All NMMA & ABYC Specs

Part #	Description	Fits Batteries	Inside Dims	Outside Dims
BHF-24S	Frame Top Battery Tray	24 Series	6-7/8"W x 10-3/8"L	7-1/2"W x 12-7/8"L
BHF-27S	Frame Top Battery Tray	27 Series	6-7/8"W x 11-15/16"L	7-1/2"W x 14-1/4"L
BHF-31S	Frame Top Battery Tray	31 Series	6-7/8"W x 13"L	7-1/2"W x 15-1/2"L



## Battery Holder Trays

- Meets All NMMA & ABYC Specs
- Quick and Easy to Install
- Rugged Hi-Strength Poly Material

Poly Strap	Battery Series	Length (Inside)	Width (Inside)	Width w/tabs (Outside)	Height
BH-24P	24	11-1/8"	7-1/4"	8-5/8"	1"
BH-27P	27	12-3/8"	7-1/4"	8-5/8"	1"
BH-31P	29/31	13"	7-1/4"	8-5/8"	1"
BS-1	Replacement Strap w/Poly Buckle				



## Space Saver Battery Holder Trays

- Fits into Tightest Spaces
- Meets All NMMA & ABYC Specs
- Recess Mounting Wells – No Tabs
- Patented Poly Strap Models or Stainless Steel Rod Models
- Quick Release Buckle on Poly Strap



Poly Strap	Stainless Rods	Battery Series	Length (Inside)	Width (Inside)	Width (Outside)	Height
NBH-24P	NBH-24S	24	10-5/8"	7"	8"	1'
NBH-27P	NBH-27S	27	12-1/2"	7"	8-1/2"	1'
NBH-31P	NBH-31S	29/31	13"	7"	8-1/8"	1'
BS-1	Replacement Strap w/Poly Buckle					

## Bungee/Shock Cords

- Components Needed to Construct Custom Straps for any Application
- Components are Offered Separately or Can Be Purchased as a Custom Part
- Contact T-H Marine for Custom Strap Production to Meet Your Specifications

Part #	Description	Size	Color
<b>STRAPS</b>			
BCORD-14B	Bungee/Shock cord	1/4" x 500'	Black
BCORD-14BW	Bungee/Shock cord	1/4" x 500'	Black & White
PCORD-14B	Polyurethane cord	1/4" - 280'	Black
<b>HOOKS</b>			
RTHOOK-1	Hook	For 1/4"	Black
RTSM-1	Screw mount	For 1/4"	Black
<b>EYES</b>			
EYE-1	Molded eye strap	1/2" ID	Black
EYESS-1	Stainless steel eye	3/8" ID	Stainless

Bungee Shock Cord



RTHOOK-1



RTSM-1



EYE-1/EYESS-1



## Pontoon Gate Latch

- Entire Unit Installs on Gate Only
- Molded Nylon for Strength – No Rattle
- Operates on Right or Left Hinged Gates
- Fits 1", 1-1/8" & 1-1/4" Square Tubing

**NOTICE: NOT DESIGNED AS A SAFETY OR LOAD BEARING DEVICE.**

Part #	Description	Color
GL-1	Gate Latch	Black
GL-2	Gate Latch	Gray

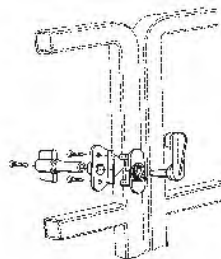

## Pontoon Door Stops

- Molded Anti-Rattle Stop
- Ribbed Models Snap Around Tube
- Fits up to 1-1/4" Square Tubing

**NOTICE: NOT DESIGNED AS A SAFETY OR LOAD BEARING DEVICE.**

Gray	Black	Type	Hinge
DS-1R	DS-1RB	W/Ribs	Right
DS-1L	DS-1LB	W/Ribs	Left
DS-2R	DS-2RB	No Ribs	Right
DS-2L	DS-2LB	No Ribs	Left

With Ribs



Without Ribs







Adjustable Tie-Down

Fixed Tie-Down

## Pontoon Fender Hanger Clips

- Easily Snaps onto Pontoon Rails
- Convenient Way to Attach Docking Fenders
- Stylish Gray Composite Material
- Adjustable Mount or Fixed Tie-Down Mounts Available



Part #	Description
PFAC-1	Adjustable Tie-Down Clip - Gray
PFH-1G	Fixed Tie-Down Clip - Gray



## Pontoon Splash Guard Deflector

- Prevents Water from Entering Floor
- Fits Between Deck Boards
- Tough Poly Extrusion
- 5 Foot Lengths

Part #	Description
PDSD-1	Pontoon Splash Guard Deflector



## Pontoon Finger Guard

- Constructed from Polypropylene

Part #	Description
PFFPG-1G	Pontoon Finger Pincher Guard - Gray
PFFPG-1LB	Pontoon Finger Pincher Guard - Lt Brown

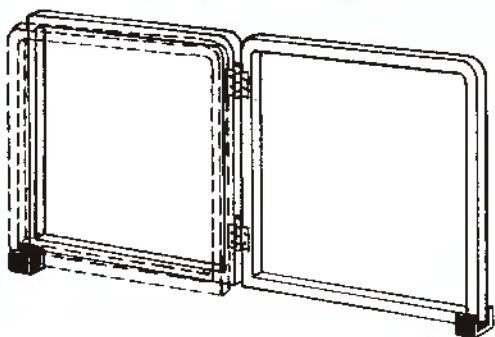

## Pontoon Gate Holders

- Holds Gates In Open Position
- Will Not Break, Rattle or Corrode
- Fits Up To 1-1/4" Square Tubing



**NOTICE: NOT DESIGNED AS A SAFETY OR LOAD BEARING DEVICE.**

Part #	Description	Color
GH-1G	Pontoon Gate Holder	Gray

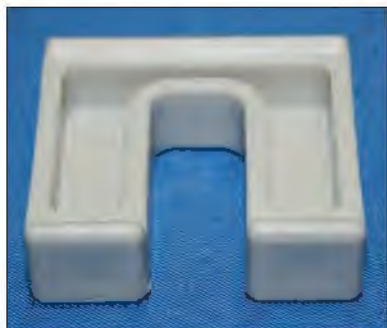

## Pontoon Rail Shims

- Uniformly Raises Rails Off of the Deck
- Unique Slotted Design for Easy Installation
- Eliminates Difficult Alignment of Shims
- Three Thicknesses Available



Gray	Black	Tan	Thickness
SPA-250G	SPA-250B		1/4"
SPA-375G	SPA-375B		3/8"
SPA-500G	SPA-500B	SPA-500LB	1/2"



## Fuel Splash Guards

- Directs Fuel Splash Away From Boat
- Great on Rolled Edge or Aluminum Boats

Part #	Fill Type	Width	Length	Hole Size
FSG-1XL	Vent or Round	4- 1/4"	7-5/8"	2"
FSG-2	Round Fill	4- 1/4"	6-1/8"	2"
FSG-2XL	Round Fill	4- 1/4"	7-5/8"	2"
FSG-3	Fits Perko # 1319	4- 1/4"	6-1/8"	2"
FSG-3XL	Fits Perko # 1319	4- 1/4"	7-5/8"	2"
FSG-7	Vent or Round	6-5/8"	4"	2"
FSG-7C	Round Carbon Fill System	6-5/8"	4"	2-1/4"
FSG-8C	Round Carbon Fill System	4-3/8"	5-1/4"	2"
FSG-10	Round Fill	4"	6"	2-1/4"
FSG-10XL	Round Fill	4"	7-1/2"	2-1/4"

- Contact us for Part # on ANY Fill.

FSG-7C



FSG-8C



FSG-10



FSG-1XL



FSG-2XL



FSG-3XL

FSG-10XL



## Steering Console Mount

- Thick .090 Welded Aluminum
- Wood Reinforced Wheel Mount Area
- Adjustable Height 10" to 20"

Part #	Description
SCM-2-DP	Steering Console Mount

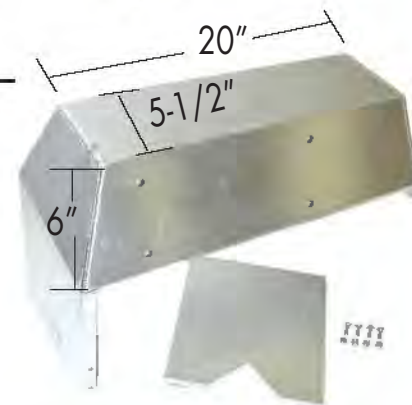
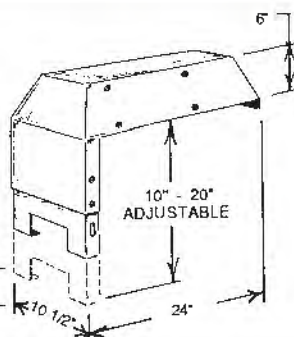

## Throttle Control Mount

- Solid .090 Aluminum
- Great for Aluminum Boats

Part #	Description
TCM-1-DP	Throttle Control Mount

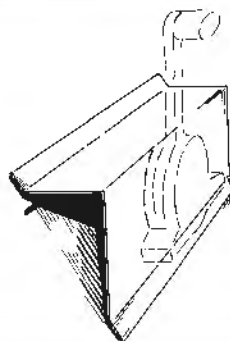





## Rub Rail Fittings

- Fits Aluminum or Rubber Rails
- Non-Corrosive Molded Ends

EC-150N	For 1-1/2" Wide Aluminum Molding w/Vinyl Insert	Black
ECR-1	For 1-1/2" Wide Rubber Molding w/Insert	Black
ECR-2	For 1-3/4" Wide Rubber Molding w/Insert	Black
SR-1	Butt Splice for 1-1/4" to 1-1/2" Rub Rail, 2-1/4" Long	Black
ECMW-2	End Cap Motor Well for 1-3/4" Wide Molding	Black
TEC-1	Trim End Cap, 1/2" to 5/8" Trim	Black
TEC-1L	Trim End Cap - Left - 1/2" to 5/8" Trim	Black
TEC-1R	Trim End Cap - Right - 1/2" to 5/8" Trim	Black
TTEC-1	End Cap for Aluminum Boat Insert - 1"W x 1-1/4"L x 3/8"T	Black
SMEC-1	End Cap for Aluminum Boat Insert - 1-1/4"W x 1-3/8"L x 5/16"T	Black



## Molded Nylon Cleats

- Tough Nylon & Molded for Strength & UV Resistance

CLEAT-4.5	Nylon Cleat	4-1/2" Black
CLEAT-6	Nylon Cleat	6" Black
CLEAT-8	Nylon Cleat	8" Black
CLEAT-10	Nylon Cleat	10" Black

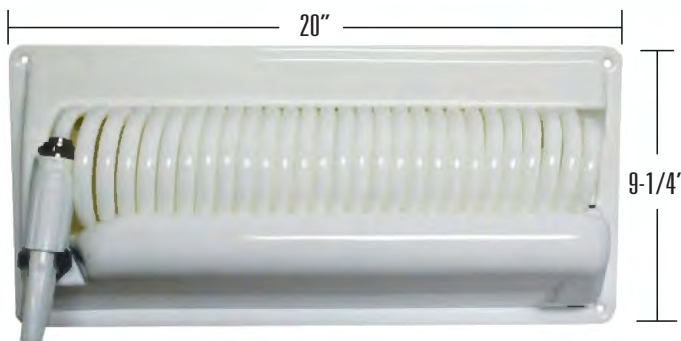

## Wash Down Hose Holder Station

- Surface Mount Affixes Anywhere on Deck
- Complete with 25' Wash Down Hose and Nozzle
- Keeps Decks Neat and Safe
- Comes with 5' of Supply Hose to Attach to Wash Down Fitting or Directly to Supply Pump
- Drain Holes in Bottom of Hose Compartment
- Available with White or Blue Hose

WDHH-25B-C-DP	Hose Holder With Blue Hose & Nozzle
WDHH-25W-C-DP	Hose Holder with White Hose & Nozzle

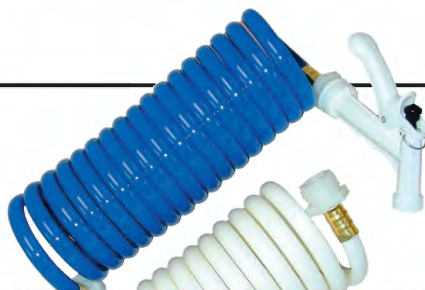

## Wash Down Station & Hose

- 1/2" Coiled Poly Hose
- UV & Chemical Resistant
- Non Corrosive Hose Fittings & Nozzles
- Station Includes Storage Tube & Screw-Out Cover

WDSB-"X"- "Y"	Wash Down Station w/15' Blue Hose & Choice of Cover Color & Nozzle Type
WDSW-"X"- "Y"	Wash Down Station w/15' White Hose & Choice of Cover Color & Nozzle Type
WDH-15B-"Y"	Wash Down Hose Only - 15' w/Choice of Nozzle - Blue Hose
WDH-25B-"Y"	Wash Down Hose Only - 25' w/Choice of Nozzle - Blue Hose
WDH-15W-"Y"	Wash Down Hose Only - 15' w/Choice of Nozzle - White Hose
WDH-25W-"Y"	Wash Down Hose Only - 25' w/Choice of Nozzle - White Hose
WDN-1	Nozzle Only - Pistol Grip Style
WDN-2	Nozzle Only - Straight Style



"X" = Color Code: 1=Black 2=Polar White 3=Sand Shell "Y" = B=Pistol Nozzle C=Straight Nozzle



# Anchor Master™ Anchor Retrieval System

- Use Boat's Power to Raise Anchor
- Slip Ring Onto Anchor Line – Attach Buoy Line
- Run Boat Into Current Away From Anchor Set
- Buoy Provides Resistance – Anchor Raises
- 12" Buoy – Stainless Ring & Snap – Rope



Part #	Description	Rope Type
AR-1-DP	Complete Anchor Master™ System*	Poly
AR-1N-DP	Complete Anchor Master™ System*	Tw Nylon
AR-0-DP	Anchor Master™ Without Buoy	Poly
AR-0N-DP	Anchor Master™ Without Buoy	Tw Nylon
ARO-1-DP	Stainless Anchor Ring Only	

\* Handles up to 20 lb. Fluke Style Anchors

# Aqua Utility Clips

- Holds Any Item Securely
- Rugged Poly Resists Sun & Salt
- Stainless Steel Spring
- Fits Standard 7/8" Rail



AUC-2	Aqua Utility Clips	White	Bulk - Each
AUC-9	Aqua Utility Clips	Blue	Bulk - Each
AUC-2PR-DP	Aqua Utility Clips	White	Packaged - 1 pair
AUC-9PR-DP	Aqua Utility Clips	Blue	Packaged - 1 pair

# Marine Grade Vinyl Caps

- Protects Bolt & Screw Threads
- Large Sizes Fit Rod Tubes



Part #	Diameter	Length
VCAP-.250	1/4"	1/2"
VCAP-.500	1/2"	1/2"
VCAP-1.375	1-3/8"	1-1/2"
VCAP-1.687	1-11/16"	1-1/2"
VCAP-2.125	2-1/8"	1-1/2"

# Prop Master™ Propeller Wrench

- Fits All 1-1/16" Prop Nuts (40hp & up)
- Rugged Nylon Resists Stripping
- 9/16" Garboard Drain Socket on Back
- Non-Corrosive in Salt Environment

Part #	Description
PMW-1	Prop Master™ Propeller Wrench







## Soft Molded Grab Handle with Stainless Steel Accent Rings

- Molded, UV-Resistant Grab Handles
- Stainless Steel Accent Rings Really Pop – Adds Rich Look
- Soft Overmold on Firm Handle
- Textured for Sure Grip
- Rubberized Ergonomic Feel
- Hidden Fasteners
- Center of Screw to Center of Screw Measures 7.25 inches
- Available in Two Colors: Black and Graphite Gray



Part #	Description	Color
GHB-1-SS	Soft Molded Grab Handle w/ Stainless Steel Accent Rings	Black
GHB-1G-SS	Soft Molded Grab Handle w/ Stainless Steel Accent Rings	Graphite Gray



## Grab Handles

- Molded – UV Resistant
- Textured for Sure Grip
- Hidden Fasteners

Part #	Description	Color
GHB-1	Grab Handle	Black
GHB-1FW	Grab Handle	Fish White
GHB-1T	Grab Handle	Tan



## G-Force Culling System

*Quick and Accurate Tournament Culling System*

- Handle Fish Only Once
- Aluminum Balance Beam
- Stainless Steel Hooks
- Eight Color Coded Buoys

Part #	Description
GFC-1-DP	Tournament Fish Culling System



## The Money Pole™ - Lure Retriever

*Never Lose Expensive Lures and Crankbaits Again*

- Rugged, Aluminum Extendable Pole
- Extends in 3 Sections to 18'
- Collapses to 6' for Easy Storage
- Superb Retriever for New Multi-Bait Rigs
- Designed by Tim Horton, Professional Angler

Part #	Description
MP-1	The Money Pole™ - Lure Retriever



*Tim Horton,  
Professional Angler*



# HYDROWAVE PRODUCT INSERT



MARINE AUDIO TECHNOLOGY

# HYDROWAVE

*Kevin VanDam*



**KVD**

**NEW!!**

The HydroWave KVD H2 is a Marine Audio Device based on the reactive senses of a Bass and other predatory fish. The HydroWave H2 delivers the latest in patented, sound emitting technology, effectively imitating the audible underwater sounds of baitfish and fish-feeding activities. Research has proven these sounds stimulate feeding in game fish. In addition to the 16 sound patterns on the H2 Bass HydroWave, the KVD H2 has 9 additional sound patterns designed by Kevin VanDam for specific fishing situations:

- Shallow Power
- Shallow Finesse
- Vegetation
- Top Water Schooling
- Off Shore Structure
- Off Shore Schooling
- Off Shore Finesse
- Marinas/Docks
- Crawfish

Our product acts as an underwater manipulative, like bait; however, it communicates to the fish's primary sensory system, the lateral line. It is involved in important behaviors such as prey detection, predator avoidance, or swimming in schools. The HydroWave is built on this science; however, our focus is prey detection. When the HydroWave is turned on, it sends out reverberations to a bigger fish's lateral line, creating a reality for them that there are smaller fish around and fellow fish are feeding on them. The bigger the fish's natural competitive instinct drives him to want to feed as well. This is how HydroWave Ignites a Feeding Frenzy and gives fishermen a considerable advantage in catching a greater number of fish.



HW-PKG-H2KVD

- 25 Sound Patterns
- Waterproof Speaker
- 16 Bit-CD Quality Sound
- Expansion Port for Additional Sounds
- 5 Pre-Programmed Delay Options (15/30/45/60/120)
- 14 Foot Cord
- Lateral & Vibration Reaction Technology
- 2.5" LCD Display
- Made in the USA

## PACKAGE CONTENT

- HydroWave KVD H2 Unit
- Waterproof Speaker with 14ft Cord
- Speaker Mounting Hardware
- Unit Mounting Bracket and Knobs
- User Guide and Warranty Card

FISHING ACCESSORIES



HYDROWAVE PRODUCT INSERT



MARINE AUDIO TECHNOLOGY

HYDROWAVE



BASS  
EDITION

NEW!!



The HydroWave Bass H2 is a Marine Audio Device based on the reactive senses of a Bass and other predatory fish, the HydroWave Bass H2 delivers the latest in patented, sound emitting technology, effectively imitating the audible underwater sounds of baitfish and fish-feeding activities. Research has proven these sounds stimulate feeding impulses in game fish.



HW-100038-11P

Bass Edition Sounds:

- Power Pattern
- Bait Blitz
- Delayed Schooling
- Schooling Blitz
- Surface Bait
- Spawning Biat
- Ultra Finesse
- Finesse
- Feeding Frenzy
- Deep Bait
- Crawfish on Gravel Finesse
- Crawfish on Sand Finesse
- Blue Back Finesse
- Bream Bed
- Active Pads

- 16 Sound Patterns
- Waterproof Speaker
- 16 bit-CD Quality Sound
- Expansion Port for Additional Sounds
- 5 Pre-Programmed Delay Options (15/30/45/60/120)
- 14 Foot Cord
- Lateral & Vibration Reaction Technology
- 2.5" Liquid Display
- Made in The USA

PACKAGE CONTENT

- H2 Unit
- Waterproof Speaker with 14' cord
- Speaker Mounting
- Six 3" Tie Wraps
- User guide & warranty card

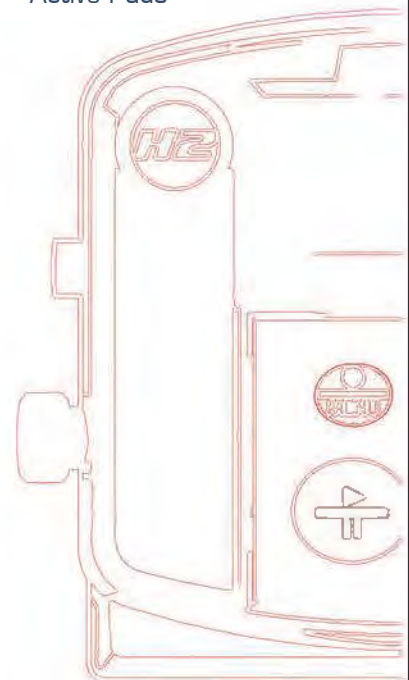

HYDROWAVE PRODUCT INSERT



MARINE AUDIO TECHNOLOGY

# HYDROWAVE

## INSHORE SALTWATER H2

**NEW!!**

The HydroWave Inshore Saltwater H2 is a Marine Audio Device with 16 sound patterns for the Inshore Saltwater environment. Baitfish recorded include shrimp, mullet, croaker, herring, cigar minnow and other popular saltwater baitfish.

The HydroWave is an electronic fishing device created to emit the sounds of a predatory fish engaged in feeding. Our product acts as an underwater manipulative, like bait; however, it communicates to the fish's primary sensory system, the lateral line, which allows fish and amphibians to perceive and localize movements in their vicinity. It is involved in important behaviors such as prey detection, predator avoidance, or swimming in schools. The HydroWave is built on this science; however, our focus is prey detection. When the HydroWave is turned on, it sends out reverberations to a bigger fish's lateral line, creating a reality for them that there are smaller fish around and fellow fish are feeding on them. The bigger the fish's natural competitive instinct drives him to want to feed as well.

This is how HydroWave Ignites a Feeding Frenzy and gives fishermen a considerable advantage in catching a greater number of fish.



HW-PKG-INSW

- 16 Sound Patterns
- Waterproof Speaker
- 16 Bit-CD Quality Sound
- Expansion Port for Additional Sounds
- Transom Speaker Mount
- 5 Pre-Programmed Delay Options (15/30/45/60/120)
- 30 Foot Speaker/Power Cord
- Lateral & Vibration Reaction Technology
- 2.5" LCD Display
- Made in the USA

### Inshore Saltwater Sounds:

- Baitfish Frenzy
- Baitfish Passive
- Baitfish Schooling
- Baitfish Finesse
- Baitfish Ultra Finesse
- Baitfish Blitz
- Herring Frenzy
- Herring Passive
- Croaker Frenzy
- Croaker Passive
- Crab Frenzy
- Crab Passive
- Mullet Frenzy
- Mullet Passive
- Shrimp Frenzy
- Shrimp Passive



HYDROWAVE PRODUCT INSERT

MARINE AUDIO TECHNOLOGY



HYDROWAVE

CATFISH · WALLEYE



The HydroWave Walleye and Catfish H2 is the next generation in the "Evolution of Sound". New features and upgrades aimed at helping fishermen experience a better and easier day on the water. Built on fishing science, the H2 sends out reverberations to a predatory fish's lateral line, sounds that help to trigger a fish's feeding instinct.

FISHING ACCESSORIES



Catfish

**NEW!!**

- Shad Passive
- Shad Frenzy
- Shad Schooling
- Skip Jack/Herring Passive
- Skip Jack/Herring Frenzy
- Skip Jack/Herring Schooling
- Bream/Sunfish Passive
- Bream/Sunfish Frenzy
- Bream/Sunfish Schooling

HW-PKG-H2CAT



Walleye

**NEW!!**

- Shad Passive
- Shad Frenzy
- Shad Schooling
- Shad Spawning
- Perch Passive
- Perch Bedding
- Perch Frenzy
- Crawfish Passive
- Crawfish Frenzy

HW-PKG-H2WALL



2.5" Liquid Crystal Display



Expansion Port for additional Sounds



16 bit- CD Quality Sound



5 Pre-Programmed Delay Options [15/20/45/60/120]



9 Sound Patterns



**HYDROWAVE PRODUCT INSERT**

**NEW!!**

# HYDROWAVE'S

## Expansion Modules

The HydroWave Expansion Modules will allow your Classic HydroWave unit or your HydroWave H2 unit additions to be expanded with different sounds. These Modules are basically plug ins for your unit to have additional sounds, giving you more options of attracting the species you are wanting to target.

### Kevin VanDam Signature Series

Kevin personally lays out his most productive loops on his KVD Signature Sounds Expansion Module. This expansion module features six exclusive sound loops that VanDam has found to be the most effective on bodies of water across the Country.



HW-EXP-KVD

### Bream Expansion Module

Truth is, where in the country can you go and not find a bass willing to eat a tasty little bluegill or frog that comes across it's path? In fact, we're all taught not to even bother to fish shallow cover unless you hear the bluegills popping. When the bluegills are popping and the frogs are hopping, the bass are most definitely chomping.



HW-EXP-BREAM

### Crawfish Expansion Module

The Hydrowave Crawfish Expansion Module is finely tuned to emit the sounds and vibrations that fish, feel, hear and sense as natural crawfish activities. The Crawfish Expansion Module features four unique crawfish sounds.



HW-EXP-CRAW

### Striper Thump Expansion Module

No fish out there is more of a schooling feeder than a striped bass. The Striper Trump Module comes with 5 exclusive baitfish vs striper sound recordings.



HW-EXP-STRIP

### Herring Expansion Module

Blueback herring don't take residence in many lakes throughout the country but if they do make a home in lakes near you. The Herring Expansion Module holds three herring specific sounds perfectly emulating this baitfish's variant conditions.



HW-EXP-HERR

### Bait Fish Expansion Module

Tricking dominate fish like these into biting requires the angler to either stumble into an active environment or simply create one on their own by using the Baitfish Expansion module to liven things up.



HW-EXP-BAIT

FISHING ACCESSORIES



HYDROWAVE PRODUCT INSERT

MARINE AUDIO TECHNOLOGY



# MR. CRAPPIE®

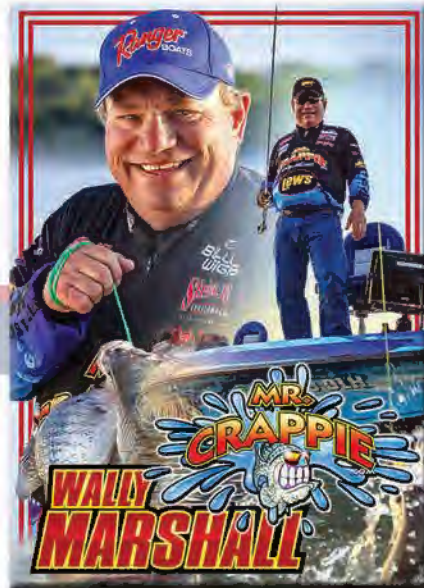

**NEW!!**



HW-PKG-H2MRCRAP

- 8 Sound Patterns
- Waterproof Speaker
- 16 Bit-CD Quality Sound
- Expansion Port for Additional Sounds
- 5 Pre-Programmed Delay Options (15/30/45/60/120)
- 14 Foot Cord
- Lateral & Vibration Reaction Technology
- 2.5" LCD Display
- Made in the USA

### PACKAGE CONTENT

- HydroWave Mr.Crappie H2 Unit
- Waterproof Speaker with 14ft Cord
- Speaker Mounting Hardware
- Unit Mounting Bracket and Knobs
- User Guide and Warranty Card

“Hey Crappie anglers! The all New Mr.Crappie HydroWave has all natural Live Action sounds of Crappie Feeding and Bait Fish! I have recorded all of these natural, live-action sounds to make crappie and bait fish Come Alive!”  
— Wally Marshall

### Mr.Crappie Sounds:

- Brushpile Majic
- Spider Rigging – Frenzy
- Tight Line – Finesse
- Bait Balls
- Busting Shad
- Finesse
- Power Trolling Frenzy
- Vertical Structure

The HydroWave is an electronic fishing device created to emit the sounds of a predatory fish engaged in feeding. Our product acts as an underwater manipulative, like bait; however, it communicates to the fish's primary sensory system, the lateral line, which allows fish and amphibians to perceive and localize movements in their vicinity. HydroWave Ignites a Feeding Frenzy and gives fishermen a considerable advantage in catching a greater number of fish.

HYDROWAVE PRODUCT INSERT



# MR. CRAPPIE®

**NEW!!**



"My Mr. Crappie HydroWave Mini is 'The Unit' to attach on docks to keep crappie and baitfish present.

My Mr. Crappie HydroWave Mini unit is perfect for small craft... keeps baitfish under your boat at all times!"  
— Wally Marshall



- Lateral & Vibration Reaction Technology
- Passive Sound
- Frenzy Sound
- Shock Resistant
- 90 Day Limited Warranty
- 9 Volt Battery
- 12 volt battery adapter available
- Amplification System
- 8 Foot Cord
- Waterproof

Preloaded with two signature Mr. Crappie sound loops, the Hydrowave Mini is powered only by a 9-Volt battery (not included), and lasts up to 6-8 hours on a single charge. Shock and Water-Resistant just like the original, you can control the volume, and play or pause sounds easily and conveniently from the head. The speaker is also attached by an 8ft cable for maximum reach. Delivering a whole new level of versatility, make the most of your fishing time with the new, portable Hydrowave Mini Marine Audio Device.

HW-PKG-MINIMRCRAP



## MR. CRAPPIE EXPANSION MODULE

The Mr. Crappie expansion card will allow the user to add the eight Mr. Crappie sound loops to their existing Classic or H2 HydroWave unit.

HW-EXP-MRCRP

FISHING ACCESSORIES



HYDROWAVE PRODUCT INSERT



Introducing the HydroWave Mini Audio Marine Technology device – a more compact, portable version of the original HydroWave. Preloaded with two of HydroWave’s most productive sounds, Passive Shad and Shad Frenzy, the HydroWave Mini is powered only by a 9-Volt battery (not included) and lasts up to 6-8 hours on a single charge. Shock and water-resistant like the original, you can control the volume, and play or pause sounds easily and conveniently from the head.

Now anglers fishing from a kayak, jonboat or even from the bank can harness the same HydroWave technology that Elite Series pros use to get inactive fish to feed and ignite feeding fish into a frenzy.



**NEW!!**



- Bass Mini: HW-PKG-MINI
- Ice Mini: HW-PKG-ICEMINI
- Catfish Mini: HW-PKG-MINICAT
- Crawfish Mini: HW-PKG-MINICAW
- Walleye Mini: HW-PKG-MINIWALL

**PACKAGE CONTENT**

- HydroWave Mini
- Waterproof Speaker with 8ft Cord
- Speaker Mounting Hardware
- User Guide and Warranty Card

- Frenzy Sound
- Passive Sound
- 9 Volt Battery
- 12 volt battery adapter available
- 90 Days Limited Warranty
- Amplification System
- Shock Resistant
- Lateral & Vibration Reaction Technology
- Waterproof
- 8 Foot Cord
- Made in The USA

HYDROWAVE PRODUCT INSERT

# ACCESSORIES



## Accessory Bag

The accessory bag includes everything needed to mount your existing HydroWave system on a new boat.



HW-ASSY-2.OBAG

## 12 Volt Kit

Allows your HydroWave mini to perform for a longer period of time on a larger power supply.



HW-ASSY-MINI12VK

## H2 2nd Boat Package

The 2nd Boat Package comes with everything necessary for anglers to pre rig each individual boat with all the needed components to run a HydroWave leaving you to just simply exchange head units and go hit the water.



HW-PKG-2.OBOAT

## Transom Bracket

Not everyone wants to mount their HydroWave onto their trolling motors. In fact, our very own Mark Courts loves his HydroWave mounted on the transom while back trolling for walleye.



HW-BKT-SPKRTRM

## H2 Replacement Speaker

The HydroWave H2 Omni Directional 16 bit speaker offers CD quality sound.



HW-ASSY-2.OSPKR

FISHING ACCESSORIES





Endorsed by Kevin VanDam

Developed With and Endorsed by Kevin VanDam



KVD Kong™ Features Unique Mechanical Nut for Securing Post to Base

## KVD Kong™ Extreme Electronics Mount

**NEW!!**

- Monstrously Strong
- Tames the Largest Beasts of Marine Electronics
  - Zero Movement in the Roughest Water Conditions
  - Marine Grade Mount for Freshwater or Saltwater
- All 6061 T6 Aircraft Aluminum and Stainless Steel
- Unique Half-Turn Quick Release Base for Easy Removal
- Built for the Largest and Heaviest Marine Electronics

Vertically Mounted



Part #	Description
SKLK-KONG-1-DP	KVD Kong™ Extreme Electronics Mount

Horizontally Mounted



PATENT PENDING

## Kong™ Wave Tamer

**NEW!!**

- Heavy Gauge Aluminum Construction
- Protects Electronics from Extreme Conditions
- Anodized Finish – Available in Black or Red
- Universal Hole Pattern Fits Most Electronics Brackets. Can Easily be Drilled for any Other Models.
- Allows Electronics to be Mounted in Center of Front Deck Behind Trolling Motor Pedal. Allows Easy Viewing while Fishing from Either Side of Boat.



Part #	Description	Color
SKTM-BK-DP	Kong Wave Tamer	Black
SKTM-R-DP	Kong Wave Tamer	Red

## Wave Away - Sonar & GPS Screen Cleaning Kit

**NEW!!**

- Specially Formulated to Clean and Protect LCD Screens
- Alcohol and Ammonia Free
- Sticks Where it is Sprayed – Resists Dripping into Sensitive Electronics
- Also Cleans Sunglasses, Cell Phones, Auto Nav Screens, LCD/LED Plasma TVs, Computer Screens & MP3 Players
- Kit Includes Screen Cleaner, 12" x 12" Microfiber Cloth and Velvet Drawstring Bag

Part #	Description
WAVE-15KIT-DP	Wave Away - 1.5 ounce kit
WAVE-27KIT-DP	Wave Away - 2.7 ounce kit







# Shock-Lock Mini Kong™ Electronics Mounts

- Unique “DOWEL PIN LOCK” No Slip Joints
- Quick Release Spring Loaded Base
- Multi-Position Pivot Points in Base
- Three Models to Fit Any Electronic Unit
- Anodized Aluminum with Stainless Fasteners
- Tested in the Most Severe Conditions by Top Touring Pros

**NEW!!**

Part #	Description	Size
SKLK-LAST-DP	Shock-Lock Mini Kong™ Mount	5" Arm - 6" Top Plate
SKLK-NAST-DP	Shock-Lock Mini Kong™ Mount	No Arm - 6" Top Plate
SKLK-SAST-DP	Shock-Lock Mini Kong™ Mount	3" Arm - 6" Top Plate



# Shock-Lock Dual Kong™

- Multi-Position Pivot Points in Base
- Anodized Aluminum with Stainless Fasteners
- Maximum Security in the Most Extreme Water Conditions
- Easily Adjustable for Different Model Electronics and Ease of Viewing
- Contact T-H Marine Customer Service for any Questions Installing into Specific Boat Models

**NEW!!**



Shock-Lock Dual Kong - Bow Mount



Shock-Lock Dual Kong - Console Mount

Part #	Description	Back Plate Dimensions
SKDK-BW36-DP	Dual Kong - Skeeter FX/ZX Dual Electronics Mount - Console, 2014-2017	15.220" x 9.505"
SKDK-BW37-DP	Dual Kong - Skeeter FX/ZX Dual Electronics Mount - Bow, 2014-2017	12.343" x 7.562"
SKDK-BW38-DP	Dual Kong - Nitro Z20/Z21 Dual Electronics Mount - Bow, 2014-2017	14.035" x 9.340"
SKDK-BW39-DP	Dual Kong - Phoenix 721/919/920/921 Dual Electronics Mount - Bow, 2010-2017	10.780" x 7.831"
SKDK-BW48-DP	Dual Kong - Nitro Z20/Z21 Dual Electronics Mount - Console, 2014-2017	13.078" x 8.500"
SKDK-BW49-DP	Dual Kong - Ranger 520/521C Dual Electronics Mount - Bow, 2013-2017	13.078" x 10.185"
SKDK-BW50-DP	Dual Kong - Ranger 520/521C Dual Electronics Mount - Console, 2013-2017	16.080" x 12.825"
SKDK-BW56-DP	Dual Kong - Phoenix 721/919/920/921 Dual Electronics Mount - Console, 2010-2017	13.078" x 8.500"
SKDK-BW57-DP	Dual Kong - Legend V20/V21 Dual Electronics Mount - Bow, 2014-2017	13.078" x 8.500"
SKDK-BW58-DP	Dual Kong - Legend V20/V21 Dual Electronics Mount - Console, 2014-2017	13.078" x 8.500"
SKDK-BW59-DP	Dual Kong - Bass Cat Pantera II Dual Electronics Mount - Console, 2014-2017	10.780" x 7.830"
SKDK-BW60-DP	Dual Kong - Bass Cat Cougar Dual Electronics Mount - Console, 2014-2017	12.343" x 7.562"
SKDK-BW61-DP	Dual Kong - Triton TRX 19/20/21 Dual Electronics Mount - Console, 2013-2017	13.960" x 9.196"
SKDK-BW62-DP	Dual Kong - Triton TRX 19/20/21 Dual Electronics Mount - Bow, 2013-2017	16.890" x 9.869"



# TACKLE TITAN™ - Tackle Management Systems

## TACKLE TITAN™ Magnetic Lure Holder & Tackle Organizer

The patented magnetic lure holder that has started a revolution in tackle management, the TACKLE TITAN™ can hold up to nine lures, plus numerous tools and small parts. The super-strong Neodymium magnets hold your lures and tools firmly, but also slide off easily when pressure is applied. Mounts on any flat surface with included 3M tape or fasteners.

- Dimensions: 13”L x 1.75”H x 1.25”D
- Available in Black and White
- Keeps What You Need Where You Need It
- Magnetic Top Shelf for Miscellaneous Items



Part #	Description	Color
TT-TITAN1-DP	TACKLE TITAN™ - Magnetic Lure & Tool Holder	Black
TT-TITAN2-DP	TACKLE TITAN™ - Magnetic Lure & Tool Holder	White

FISHING ACCESSORIES



**NEW!!**



## TACKLE TITAN™ MINI - Magnetic Lure Holder & Tackle Organizer

The smaller version of the patented magnetic lure holder that has started a revolution in tackle management, the TACKLE TITAN™ MINI offers the same innovative tackle management as the original TACKLE TITAN – on a smaller scale.



This four-magnet unit can fit into a multitude of convenient spaces to keep your most-used tackle right at your fingertips. Fishing will never be the same. The super strong Neodymium magnets hold your lures and tools firmly, but also slide off easily when pressure is applied. Mounts on any flat surface with included 3M tape or fasteners.

- Dimensions: 6” L x 1.25” H x 1.25” D
- Available in Black and White
- Keeps What You Need Where You Need It
- Magnetic Top Shelf for Miscellaneous Items

**NEW!!**



Part #	Description	Color
TT-MINI1-DP	TACKLE TITAN™ - MINI - Magnetic Lure & Tool Holder	Black
TT-MINI2-DP	TACKLE TITAN™ - MINI - Magnetic Lure & Tool Holder	White



# TACKLE TITAN™ - Tackle Management Systems

## TACKLE TITAN™ LURE MANAGER - Magnetic Lure Manager Pair

**NEW!!**

The patent pending TACKLE TITAN™ LURE MANAGER is a magnetic tackle management system that will change the way you fish! It features two units with five super magnets on each unit. The two units work as a pair to hold lures at any angle, and keep them safe, secure, and conveniently located. Mount the TACKLE TITAN™ LURE MANAGER to the inside of a storage compartment, to a sidewall, or under a hatch, and keep your lure collection handy at all times.



Dimensions: 6" L x 1.25" H x 1.25" D

Part #	Description
TT-TLMAN1-DP	TACKLE TITAN™ - Magnetic Lure Manager - Pair - Black



## TACKLE TITAN™ LURE MANAGER SYSTEM - Magnetic Lure Management System

**NEW!!**

The patent pending TACKLE TITAN™ LURE MANAGER SYSTEM is a complete tackle management system in one convenient package. It includes four pairs of Lure Hangars plus a 12" x 6.5" galvanized metal mounting plate – big enough to store 20 lures. Mount the TACKLE TITAN™ LURE MANAGER SYSTEM to the inside of a storage compartment lid or compartment sidewall to keep your lure collection safe and organized like never before.

Part #	Description	Color
TT-TLMS1-DP	TACKLE TITAN™ - Magnetic Lure Management System	Black

## Cook's Go-To Tackle Storage System

**NEW!!**

A revolutionary new system that converts the dead space under the deck compartment lids of your boat into highly usable, exceptionally convenient storage space. Perfect for hanging spinnerbaits and jigs, it also includes clips to store packed soft plastic baits. When your deck lid is open, baits stored in the organizers may be easily taken out, however, when the lids are closed, all baits are securely locked into place, keeping them tangle-free – even in rough water.

- Rack Dimensions: 12" x 1" x 1"
- Includes: 2 Racks, 12 Rings, Screws & Hardware, and Installation Instructions
- Tournament-Tested & Rough Water Proven
- Made in the USA

Part #	Description	Color
TT-CGTS1-DP	Cook's Go-To Tackle Storage System	Black
TT-CGTS2-DP	Cook's Go-To Tackle Storage System	White







Proudly Serving the Marine Industry for Over 40 Years

# TACKLE TITAN™ - Fishing Accessories



## TACKLE TITAN™ Knife & Plier Holder

**NEW!!**

- Holds 1 set of Pliers and Carbineer, 2 Knives, 13 Hook and Lure Holders
- UV, Weather and Corrosion Proof
- Two Suction Cups for Customizable Installation

TT-52071 Tackle Titan™ Knife & Plier Holder

## TACKLE TITAN™ Single Electronics Caddy

**NEW!!**

- No Tools Required for Installation
- Includes Two Large Suction Cups
- Can be Removed and Re-applied
- Two Storage Compartments

TT-52072 Tackle Titan™ Single Electronics Caddy



## TACKLE TITAN™ Large Gear Caddy

**NEW!!**

- No Tools Required for Installation
- Can be Removed and Re-applied
- Includes Two Large Suction Cups
- Two Storage Compartments

TT-52070 Tackle Titan™ Large Gear Caddy



**NEW!!**

## TACKLE TITAN™ Single Drink Holder

- No Tools Required for Installation
- Can be Removed and Re-applied
- Includes Two Large Suction Cups
- Slots for Lures and Pliers

TT-52076 Tackle Titan™ Single Drink Holder

## 12V Waterproof Battery Pack, Rugged Case

- Provides a 12V Power System Anywhere
- Includes 3 Customizable Accessory Connectors, Wall Charger & 12 Volt Utility Charger
- Water/Weather Resistant; Heavy Duty Dry Box Construction
- Max Operating Amperage: 3.0AMPS-12VDC-7.0AmpHours
- Great for Kayaks, Canoes, Small Boats, Camping, Power Outages & More

PWRBX-12V 12V Waterproof Battery Pack, Rugged Case



**NEW!!**

FISHING ACCESSORIES



# PEDAL PADDLE



**NEW!!**



The PEDAL PADDLE is a patent pending, movable mount for foot control trolling motor pedals. This secures the foot pedal and rotates around the seat pedestal.

- Easy Installation
- Low Profile and Appealing
- Keeps Your Trolling Motor Pedal Accessible
- Takes the Work Out of Controlling Your Boat
- Fits Most Brands of Foot Controlled Trolling Motor Pedals
- Adjustable for Maximum Comfort

Part #	Description
PEDP-1-DP	Peddle Paddle

*Don't Miss the Big Catch because Your Pedal is on the Other Side of the Boat!*



MinnKota Trolling Motor  
HDWR0458  
8 x 7/8" Phillips Oval Head SS  
Screw (4x)



Motorguide Trolling Motor  
HDWR0675  
1/4 - 20 x 1-1/4" Phillips Flat Machine  
Screw (3x)



Adapters to fit on 3/4" pin pedestal and 1.77 inch pedestal





# PRODUCT INSERT



QUALITY PRODUCTS | PRECISION MACHINING







## Hydraulic Power-Lift® Transom Jacks



Ideal for high speed positioning of outboard motor

*The High Speed Power-Lift is the newest addition to the product line. The model PL-65HS High Speed Power-Lift will raise V-6 300 h.p. and smaller outboard motors in approximately 8 seconds which is twice as fast as the regular PL-65 that has been in the market since 1982. Ideal for those who want a jack plate for high speed positioning of their outboard motor.*

**5.5" SET-BACK  
MODEL PL-65HS**  
#65301 - w/ gauge  
#65302 - w/o gauge

**10" SET-BACK  
MODEL PL-65-10HS**  
#61301 - w/ gauge  
#61302 - w/o gauge

**MOUNTING HARDWARE INCLUDED WITH CMC LIFTS.**  
\*The Model PL-65 is rated for V-6 and smaller motors. Not designed for V-8 motors or racing applications. See Model PL-65SS.

### Accessories



The optional position indicator is sealed and drip proof and mounts in the dash for safe and convenient height determination. The indicator features an up-down toggle switch as standard equipment. The sending unit is completely sealed and waterproof.

#### CUSTOM WASHER PLATES

The top washer plate can be custom engraved with no minimum order. Up to 16 characters can be engraved.

#20000



#### TRANSOM WASHER PLATES

Made of strong 3/8" 6061 T6 alloy aluminum (not cast aluminum), the CMC transom washer can eliminate bolts "biting" into transoms and can more evenly distribute loads on high performance engines. Hole centers: Top Plate - 12 7/8" Bottom Plate - 9 7/8"

Top Washer Plate #20022

Bottom Washer Plate #20032







Our most popular model, the PL-65 is rated for V-6 and smaller motors and provides 5" of vertical travel. It is not designed for V8 motors or racing applications. See model PL-65SS.



5 1/2" SET-BACK  
MODEL PL-65\*  
#65001 - w/ gauge  
#65002 - w/o gauge

10" SET-BACK  
MODEL PL-65-10  
#61001 - w/ gauge  
#61002 - w/o gauge



MODEL PL-65SS  
#65201 - w/ gauge

The same rugged lift system as our PL-65 units with the addition of 1/2" stainless steel motor rails that give this jack the strength and power to lift V6 and V8 engines of 300hp max. The solid stainless rails have no castings or welds to break making this the strongest jack in our lineup. The roller assembly contains a stainless steel 3/4" pin with aluminum-bronze alloy rollers for less friction, longer wear and virtually no binding.

CMC MARINE • PRODUCT INSERT

## With CMC, there is no need for a hydraulic tank, motor, pump and hoses inside your boat!

### TRANSOM WEDGES/SET BACK SPACERS

These 2 degree wedges are designed to give extra positive or negative trim. The wedges are used as an aid for boats with an insufficient transom angle or for boats having planing problems at low speed. Our unique design of the CMC Transom Wedges allows you to also use them as set back spacers, by simply inverting 2, 4, and 6 sets. Hole design fits the same pattern as the Power-Lift transom bracket and standard motoring mounting.

SIZE: 1/2" x 4" x 11 1/4" #20122



### TRIM BUTTON SWITCH

This weatherproof trim button switch is made of molded black plastic with raised white letters. It can easily be wired to the PT-130 Power Tilt and Trim or Power-Lift wire assemblies.

#20220



### WATER PRESSURE GAUGE

The water pressure gauge is sealed and drip proof and is mounted in the dash of the boat. The gauge registers from 0 - 30 P.S.I.

#20320





## Manual Power-Lift® Transom Jacks

### Manual Features:

- One Piece Design
- Made of 6061 T6 extruded aluminum alloy
- Stainless steel fasteners for maximum strength and durability
- Centrally located adjustment screw for positive alignment
- 5 1/2" Set Back from Transom
- 5" Vertical Adjustment
- Designed to fit standard B.I.A. bolt pattern without drill holes or making modifications in the boat or motor.



10" SET-BACK MODEL ML-65-10\*  
#61012



5 1/2" SET-BACK  
MANUAL ML-65\*  
#65012



MANUAL ML-65SS  
#65212

The ML-65 and the 4 and 5 1/2" set back plates are rated for V-6 and smaller motors. They are not designed for V8 or racing applications.

The ML-65SS is rated for V-8's and racing applications and is equipped with stainless steel motor rails.

With CMC, you can adjust your Power-Lift from the top or bottom!

The CMC manual Power-Lift provides the added convenience of adjusting from the top or the bottom. Most competitive brands can only be adjusted from the top.



### TWO-PIECE DESIGN

The two-piece adjustable manual has 5 inches of slot adjustment at the motor mounting bracket and 1 1/2 inches of adjustment at the transom bracket.

5 1/2" Set Back #55012\*  
4" Set Back #40012\*





## Static Set Back Plates



### The 7 INCH STATIC SET BACK PLATE

has 1 1/2 inches of adjustment at the transom bracket and 1 inch of adjustment on the motor bracket. The dimension from the top of the transom to the top of the motor side is 3 1/2 inches.

#70012\*



### The 9 INCH STATIC SET BACK PLATE

also has 1 1/2 inches of adjustment at the transom and 1 inch of adjustment on the motor bracket. The dimension from the top of the transom to the top of the motor side is 5 3/4 inches.

#90012\*

**MOUNTING HARDWARE INCLUDED WITH #70012, #90012, AND 65213 BUT NOT WITH #50012.**

*\* These Models are rated for V-6 and smaller motors. Not designed for V-8 motors or racing applications.*

### The 5 INCH VERTICAL EXTENSION

allows the motor to be mounted 5 inches higher than the standard mounting on the transom. It is a must for conversion from prop to jet drive.

Another application includes mounting the 5 inch vertical extension on the hydraulic Power-Lift to raise the motor higher on shallow running boats that are equipped with tunnel extensions.

#50012\*

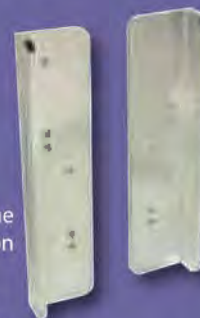

### The 2-1/2 INCH STATIC SET BACK PLATE

has 1 1/2 inches of adjustment at the transom. It is most commonly used in conjunction with the manual or hydraulic Power-Lift to give a total of 8 inches of set back.

#65213\*



## Transom Jack Specifications

ITEM	DESCRIPTION	MOTOR HP RATING	TRAVEL	SET BACK	OPERATION	CONSTRUCTION	FASTENERS	DIMENSIONS	PRODUCT WEIGHT
61002	PL-65-10 w/o gauge	Up thru V-6	5"	10"	12V Elec Hydraulic	Extruded 6061-T6 Alum. Alloy	Stainless Steel	18-1/8" W x 16-1/2" H	56#
65002	PL-65 w/o gauge	Up thru V-6	5"	5 1/2"	12V Elec Hydraulic	Extruded 6061-T6 Alum. Alloy	Stainless Steel	18-1/8" W x 16-1/2" H	45#
65201	PL-65SS w/gauge	Up thru V-8	5"	5 1/2"	12V Elec Hydraulic	S.S. Motor Rails & 6061-T6 Alum.	Stainless Steel	18-1/8" W x 15-1/2" H	67#
65213	2-1/2" Set Back	Up thru V-6	1-1/2"	2-1/2"	Static	Extruded 6061-T6 Alum. Alloy	Stainless Steel	15-1/8" W x 13-5/8" H	11#
65012	ML-65	Up thru V-6	5"	5 1/2"	Manual	Extruded 6061-T6 Alum. Alloy	Stainless Steel	18-1/8" W x 15-1/2" H	32#
61012	ML-65-10	Up thru V-6	5"	10"	Manual	Extruded 6061-T6 Alum. Alloy	Stainless Steel	18-1/8" W x 15-1/2" H	43#
65212	ML-65SS	Up thru V-8	5"	5 1/2"	Manual	S.S. Motor Rails & 6061-T6 Alum.	Stainless Steel	18-1/8" W x 15-1/2" H	56#
55012	2-PC. Manual	Up thru V-6	5"	5 1/2"	Manual	Extruded 6061-T6 Alum. Alloy	Stainless Steel	18-1/8" W x 15-1/2" H (Mounted)	23#
40012	2-PC. Manual	Up thru V-6	5"	4"	Manual	Extruded 6061-T6 Alum. Alloy	Stainless Steel	18-1/8" W x 15-1/2" H (Mounted)	20#
70012	Static Set Back	Up thru V-6	3 1/2"	7"	Static	Extruded 6061-T6 Alum. Alloy	Stainless Steel	18-1/8" W x 15-1/2" H (Mounted)	30#
90012	Static Set Back	Up thru V-6	5 3/4"	9"	Static	Extruded 6061-T6 Alum. Alloy	Stainless Steel	18" W x 15-1/2" H (Mounted)	27#
50012	5" Vertical Ext.	Up thru V-6	5"	1/2"	Static	Extruded 6061-T6 Alum. Alloy	Stainless Steel	5" W x 20-1/2" H (Mounted)	14#

*Specifications subject to change without notice.*





A T-H Marine Company

## Electric Hydraulic Tilt N' Trim

*You Get Power Tilt & Trim, Better Boat Handling, More Speed, Lower Fuel Consumption and No More Back Strain!*



### PT-130 FEATURES:

- Rated for 130 H.P. and Smaller Motors.
- 6" Set Back to Enhance Boat Stability and Performance.
- 20° of Trim and a Total of 90° of Tilt and Trim.
- 1/2" 6061 T6 Extruded Aluminum Construction with Stainless Steel Fasteners.
- Electric Hydraulic Actuator Rated at 7853 lbs. of Thrust!
- Standard B.I.A. Bolt Hole Pattern.
- Convenient Adapter Kit Available for Clamp-on Motors.
- Four Stainless Steel Motor Mounting Bolts Included.



### PT-35 FEATURES:

- Rated for 35 H.P. and Smaller Motors.
- 5 1/2" Set Back to Enhance Boat Stability and Performance.
- 84° of Trim and Tilt.
- 1/4" 6061 T6 Extruded Aluminum Construction with Stainless Steel Fasteners.
- Electric Hydraulic Actuator Rated at 7853 lbs. of Thrust!
- Accommodates Clamp-on or Bolt-on Motors Without the Need of an Adapter.
- Weighs Only 24 Pounds!

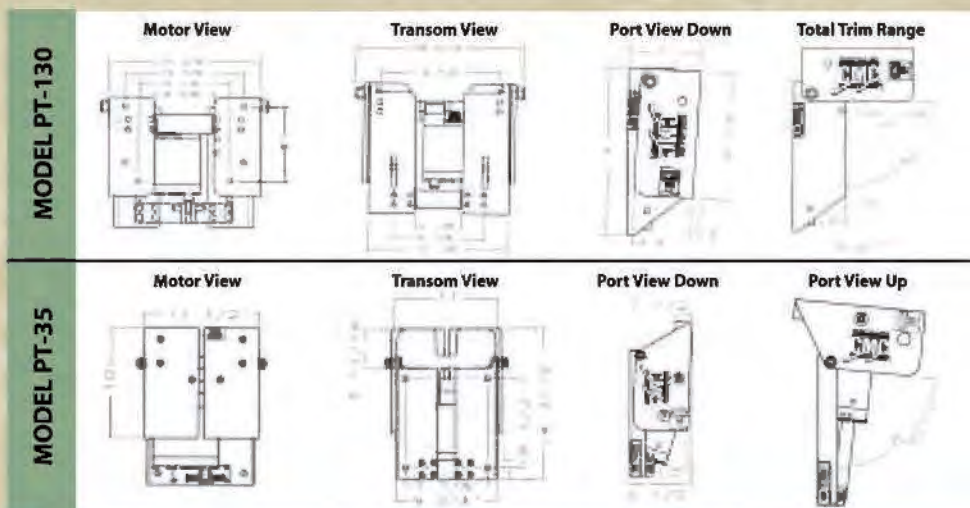

\* The inside dimension of the motor mounting area of the PT-35 is 11 inches. Before ordering, please make sure that the maximum width of the clamp mounting feet and/or mounting bolts of the motor that must fit into this area does not exceed this 11 inch limit. Refer to the transom view drawings. Mounting bolts are not included with the PT-35.





### TRANSOM CLAMP MOTOR ADAPTER

For installation of motors mounted with transom clamps, an adapter kit is available from CMC. This adapter kit is made for quick and easy installation of these type motors. The photo above shows this adapter on a PT-130 with a transom clamp motor. #13022



The optional tilt and trim gauge (not available with the PT-35) is sealed and drip proof and mounts in the dash of the boat for safe and convenient height determination. The sending unit is completely sealed and waterproof, which eliminates any moisture problems. The up-down toggle switch is standard equipment.

### TRANSOM SPACER FOR PONTOON BOAT

The transom on some pontoon boats are inset with an aluminum lip along the sides. To conveniently mount the PT-130 to this type transom, this transom spacer is available. The transom spacers are 1 inch thick allowing you to mount the PT-130 without interference with the 1/2" to 3/4" lip around the transom on some pontoon boats. #13032



### CMC BREAKAWAY UNIT

The CMC BA-130 Breakaway unit is designed for duck hunters and/or fisherman that use their boat in shallow stumpy areas. It allows small boats and motors to slide over submerged logs or debris at low speeds to get to a downed bird or your favorite fishing hole.



The BA-130 is rated for outboard motors up to a maximum of 130 H.P. The unit is mounted between the boat transom and the outboard motor. It is designed to help minimize damage to the outboard motor and boat transom only when an obstruction is encountered while running at speeds under 5 M.P.H. in the forward direction. As it encounters an obstruction momentum causes motor to deflect and rotate up to 45 degrees to slide over the obstruction. A drawbar spring is incorporated in the unit to help return the motor to its normal position while operating in the reverse direction at low R.P.M. The BA-130 is not designed to encounter obstructions while the boat is being operated in the reverse direction.

The unit is pre-drilled with the standard B.I.A. hole pattern. For motors that have clamps with thumb screws, CMC part # 13022 Transom Clamp Adapter is required. Product weight is 28 pounds (shipping weight is 33 pounds).

## Tilt N' Trim Specifications

ITEM	DESC.	MOTOR HP RATING	TRAVEL	SET BACK	OPERATION	CONSTRUCTION	FASTENERS	PROD WT
13001	PT-130 w/gauge	10 HP thru 130 HP	90° Trim and Tilt	5"	12V Elec Hydraulic	Extruded 6061-T6 Alum. Alloy	Stainless Steel	40#
13002	PT-130 w/o gauge	10 HP thru 130 HP	90° Trim and Tilt	6"	12V Elec Hydraulic	Extruded 6061-T6 Alum. Alloy	Stainless Steel	39#
32100	PT-35	35 HP & Smaller	84° Trim and Tilt	5 1/2"	12V Elec Hydraulic	Extruded 6061-T6 Alum. Alloy	Stainless Steel	24#

Specifications subject to change without notice.



# Alphabetical Index

## A

Access Covers .....	5-7
Access Door – Designer Series™ .....	4
Access Hatches .....	3, 4
Access Hatches, Designer Series.....	3
Actuators – Atlas™, Micro Jacker™ .....	8-12
Adapter Fittings.....	34
Aeration Fitting, Directional .....	22
Aeration Kits, Baitwell.....	20
Aeration/Livewell Systems .....	20
Aerator Controls .....	20
Aerator Filter Domes.....	29
Aerator Filters .....	30
Aerator Heads .....	22, 24
Aerator Pump Brackets.....	22
Aerator Pump Screens .....	30
Aerator Spray Head/ Wash Down Fitting .....	22
Aerator Screens.....	30
Aerator Timers .....	20
Aerator, Max-Air Venturi.....	20
Aerator, Pro-Air.....	20
Air Pump Aeration .....	22
Alarm, Banshee™ Padlock.....	76
Alarm, Two Way.....	76
All Purpose Drains .....	27
All Purpose Drains, Flat Head.....	27
All Purpose Strap.....	80
Anchor Handle Locks & Latches.....	2
Anchor Retriever, Anchor Master™.....	87
Aqua Clips / Utility Clips.....	87
Arm, Seacock Remote .....	31
Atlas™ Heavy Duty Hydraulic Jack Plates.....	8
Atlas™ Hydraulic Jack Plates.....	8
Atlas Micro Jacker™.....	10
Atlas Micro Jack™ - Clamp on Adapter .....	10
Atlas™ Series Position Gauge Kit.....	10
Atlas™ Series Hot Shot™ Hole Shot Plates.....	10
Automatic Aerator Control.....	20

## B

Bait Well Filter .....	30
Bait Well Kits .....	21
Ball Scupper.....	25
Banshee™ Alarm Padlock.....	78
Base Plug, Pedestal .....	37
Battery Case, Waterproof.....	14
Battery Holder for Optima .....	81
Battery Holders .....	81
Battery Operated Lights, LED.....	71
Battery Tray, Frame Top .....	84
Battery Tray Replacement Straps .....	81
Battery Trays .....	81, 82
Battery Trays – Combo 24-27 .....	81
<b>BOATING AND MARINE ACCESSORIES .....</b>	<b>73-88</b>
Bolt Caps .....	87
Bolt Kit, Jack Plate.....	12
Boots, Cable.....	46
Bounce Buster Coaster .....	41
Boxes - Tackle Tray .....	3, 4
Bracket, Aerator Pump .....	22
Bracket, Light Mounting.....	76
Brackets, Cooler Mounting .....	80
Brite Plate™ Chrome Plated Parts.....	23
Brite Plate™ Chrome – Splash Well Drain .....	27
Bulkhead Pass-Thru Fitting .....	32
Bulkhead Strain Relief Kit.....	42
Bungee/Shock Cord Material .....	83

## C

Cable Boot Rings .....	46
Cable Boots.....	46
Cable Boot Grommets.....	45
Cable Ties .....	43
Caddy, Single Electronics .....	102
Caddy, Large Gear.....	102
Camera Extension Mounting Sticks .....	74-75
Cams, Anchor Lock, Zinc & Stainless.....	2
Cam Lock Deck Plates .....	5
Caps, Black Vinyl.....	35, 87
Cases, Battery.....	100
CeaCap™ Bulkhead Fitting .....	31
Cell Phone Holder & Charger.....	74
Chrome Plated Parts.....	23
Circuit Breaker Kit, Trolling Motors.....	41
Clam Shell Vents .....	46
Clamp-On Outboard Adapter for Micro Jacker.....	9
Clamps, Hose.....	43, 44
Cleats .....	86
Clips, Aqua/Utility.....	87
Clips, Navigation Light .....	76
Clips, Trailering.....	77
Clips, Livewell Overflow Tube.....	29
<b>CMC MARINE JACK PLATES &amp; TRIM UNITS .....</b>	<b>104-110</b>
CMC Wedges/SetBack Spacers.....	15
Cockpit Drain.....	24, 25
Cooler Mounting Kit .....	82
Courtesy Lights – LED Models.....	64-70
Courtesy Lights – Incandescent Oval w/Switch .....	66
Cover, Wire.....	45
Covers, Access .....	5-6
Covers, Vent.....	28
Culling System, G-Force .....	88
Cup Holder Insert, LED .....	72, 78
Cup Holder LED Accent Ring.....	72, 79
Cup Holder, Flexible Drink Stabilizer .....	79
Cup Holder, Stainless Steel.....	78, 79
Cup Holders .....	78, 79

## D

Deck Drains, Thru-Hull.....	24, 29
Deck Lid Slam Latch.....	2
Deck Plates .....	5, 6
Deck Plates, Low Profile Twist Out .....	5, 6
Deck Plates, Quick Release Cam.....	5
Decorative Wire Covers.....	45
Designer Series™ Glove Boxes .....	3
Designer Series™ Hatches.....	3
Designer Series™ Screw Down Deck Plates .....	6
Designer Series™ Tackle Tray Centers .....	4
Designer Series™ Vertical Access Door with Vent.....	4
Digital Gauge Kits for Atlas™ Series Jacks .....	10
Directional Flow Aerator Heads .....	23
Directional Livewell Fill Fitting.....	23
Door Latch.....	2
Door Stops, Pontoon.....	83
Door Strap .....	7
Drain Caps, Rod Holders.....	35
Drain Filters.....	28
Drain Plugs .....	28
Drain Tubes.....	29
Drain Tubes, Livewell Overflow .....	28, 29
Drain, All Purpose.....	27
Drain, All Purpose, Threaded .....	29
Drain, Cockpit.....	24
Drain, Deck.....	25





Drain, Flapper Scupper .....26  
 Drain, Flex Flange.....26  
 Drain, Floor.....28  
 Drain, Hatch.....27  
 Drain, Impact.....27  
 Drain, Overflow.....28  
 Drain, Push-In.....27  
 Drain, Rod Holder.....36  
 Drain, Scupper.....25-26  
 Drain, Seat Pedestal.....27  
 Drain, Splash Well.....27  
 Drink Holder, Folding.....80  
 Drink Holder, LED Lighted Stainless Steel Rim.....72, 79  
 Drink Holder, Molded with Stainless Steel Rim.....79  
 Drink Holder, TACKLE TITAN™.....102  
 Dry Cases.....102  
 Dual Battery Tray.....82  
 Duckbill Scupper.....25

**E-F**

Earth Magnetic Latches.....2  
 Elbow Fittings.....35  
 Electronic Caddy.....102  
 Electronics Mounts.....98, 99  
 Emergency Reboarding Ladder.....13  
 End Caps.....35, 87  
 Engine Flush Kits.....76  
 Engine Jacks.....8-12  
 Evinrude G2 Motor Support.....77  
 Eye for Straps.....83  
 EZ Pump™ - Advanced Water Pick Up System.....21  
 Fastener, Windshield.....81  
 Fender Hanger Clips, Pontoon.....84  
 Filter, Aerator.....30  
 Filter, Bait Well.....30  
 Filter, Drain.....28, 31  
 Filter, Overflow Drain.....31  
 FingerFlex™, Trim Control for Hydraulic Steering.....13  
 Finger Guard, Pontoon.....82

**FISHING ACCESSORIES.....88-103**

Fishing Rod Holders.....35-37  
 Fittings, Brite Plate™.....23  
 Fittings, Bulkhead Pass-Thru.....31  
 Fittings, CeaCap™.....31  
 Fittings, Directional Livewell Fill.....23  
 Fittings, Hose.....34  
 Fitting, Overflow.....31  
 Fittings, Plumbing.....32, 33  
 Fittings, Rub Rail.....86  
 Fittings, Thru-Hull.....32  
 Fittings, Wash Down.....22  
 Flange, Rigging.....43  
 Flange – Rigging Hose Union.....43  
 Flange – Rigging w/Fuel Hose Port.....43  
 Flange – Tri Shape Rigging.....43  
 Flange, Vent Hose.....43  
 Flapper Scupper Drains.....26  
 Flapper Scupper Repair Kit.....26  
 Flex Flange Thru-Hull Drain.....26  
 Flex Sleeving.....42  
 Floor Drain.....28  
 Floor Drain/Lid Pull Combo.....28  
 Flow-Max™ Ball Scupper.....25  
 Flush Mount Scupper Adapters.....26  
 Flusher for Twin Outboards.....76  
 Folding Drink Holder.....78  
 Foot Control Switch.....41  
 Foot Control, Peddle Paddle.....103  
 Foot Throttle.....14

Foot Throttle Mount.....14  
 Foot Trim Controls.....13  
 Fuel Container Hold-Down Kit.....80  
 Fuel Splash Guard.....85

**G**

G-Force Handle.....39, 40  
 G-Force Culling System.....88  
 G-Force Eliminator™ Prop Nut.....38  
 G-Force Equalizer™.....39  
 G-Force Silencer™.....39  
 G-Juice™.....18  
 Garboard Drain Plug & Base.....28  
 Garboard Drain Wrench.....28  
 Gaskets for Thru Hulls.....31  
 Gate Holder, Pontoon.....84  
 Gate Latches, Pontoon.....83  
 Gauge Kit, Atlas™ Series.....10  
 Gear Caddy.....102  
 Glove Box, Designer Series.....3  
 Grommet, Cable Boot.....45  
 Grommet, Cable Pass-Thru.....45  
 Grommet, Oval.....46  
 Grommet, Rope.....46  
 Grommet, Rod.....36  
 Grommet, Utility.....46  
 Grab Handles.....88

**H**

Handle, G-Force.....39, 40  
 Handles, Grab.....88  
 Hanger Clips, Pontoon Fender.....84  
 Harness – Atlas™, Micro Jacker™.....8-10  
 Hatch Drain.....27  
 Hatch Spring.....6  
 Hatches, Designer Series.....3  
 Hatches - Designer Series - Locking.....3  
 Headlight, Trolling Motor.....41  
**HATCHES, PLATES & LIDS.....2-7**  
 Hi-Jacker Jack Plates.....12  
 Hold-Down Kit – Fuel Container.....82  
 Holder, Battery.....81-83  
 Holders, Cup.....78, 79  
 Holders, Drink, TACKLE TITAN™.....102  
 Holders, Knife & Plier, TACKLE TITAN™.....102  
 Holder, Navigation Light.....76  
 Holder, Pedestal.....37  
 Holder, Pontoon Gate.....84  
 Holder, Rod.....37  
 Holder, Spare Propeller.....80  
 Holders - Oval Top.....37  
 Hole Shot Plate, Hot Shot™, Z-Lock™.....9  
 Hooks for Shock Cord.....83  
 Hose Clamps.....45  
 Hose Clamps, Oetiker.....44  
 Hose Elbows.....33  
 Hose Fittings.....34  
 Hose Reducers.....33  
 Hose Tees.....33  
 Hose/Wire Hanger.....45  
 Hose, Coiled Wash Down.....86  
 Hose, Rigging.....42  
 Hot Foot™ Slide Mount.....14  
 Hot Shot™ Hole Shot Plates for Atlas™ Series Jack.....9  
 Hot Shot™ Hole Plates for Z-Lock.....11  
 Hot Trim™ Foot Trim Control.....13  
 Hot Foot™ Throttle.....14  
 Hydraulic Hose Strain Relief Fitting.....42  
 Hydraulic Jack Plates.....8-12



Hydro-Tail Stabilizer.....16	Speaker LED Accent Ring.....72
<b>HydroWave – Marine Audio Technology – Product Insert.....89-97</b>	LED Light Kits.....56-57
HydroWave KVD H2.....89	LED Lighting Kit for Boats.....56
HydroWave Bass Edition H2.....90	LED Lighting Kit for Trailers.....56
HydroWave Inshore Saltwater H2.....91	High Intensity Oval LED Courtesy Light/Rock Light Kits.....57
HydroWave Catfish & Walleye H2.....92	LED Linear Lighting.....60-63
HydroWave Expansion Modules – Kevin VanDam, Bream, Crawfish, Striper Thump, Herring, Bait Fish.....93	LED Flex Strip Lights.....60
HydroWave Mr.Crappie H2.....94	LED Flat Rope Lights.....61
HydroWave Mr.Crappie Mini & Expansion Module.....95	LED Flat Rope Lights – RGB Color Changing.....61
HydroWave Bass, Catfish, Crawfish, Ice, Walleye Minis.....96	LED Flex Strip Lights with Track.....62
HydroWave Accessories.....97	LED Flex Strip Lights – Battery Operated.....62
<b>I-J-K-L</b>	LED Flex Strip Lights – Mounting Track & Track Ends.....62
Ignition Cutoff Switch.....16	LED Flex Strip Lights – Ultraviolet LED Strip Lights.....63
Impact Drains.....27	Flexible LED Light Bar.....63
Inline Scupper.....25	LED Module Pod Light Strings.....63
Jack Plate Bolt Kit.....12	LED Navigation Lights.....52-55
Jack Plate - Atlas Micro Jacker™.....10	Combination Bow.....52
Jack Plates, Hi-Jacker™.....12	Single Side Bow Lights.....52
Jack Plate, Hole Shot Plate, Hot Shot™.....9	LED Flex Strip Bow Lights.....53
Jack Plates.....8-12, 104-110	LED Bow Light Combination Kit – Battery Operated.....53
Jack Plates – Manual – Z-Lock.....11	Shark Eye Nav Lights.....53
Key, Replacement for Anchor Handle Locks.....2	LED Stern Lights & Bases.....54
Kill Switch.....16	Bimini Top.....55
Kill Switch Lanyard.....16	Snap Flex Bases.....55
Knife & Plier Holder, TACKLE TITAN™.....102	Snap Flex Stern Lights.....55
Kong™ Wave Tamer.....98	LED Pontoon Light Kits.....58-59
KVD Kong™ Extreme Electronics Mount.....98	Pontoon LED Module String Light Kit – Blue.....58
Ladder - Emergency Reboarding.....13	Pontoon LED Flat Flexible Ribbon LED Strip Light Kit – Blue...59
LANE BLASTER™ LED Trolling Motor Headlight.....41	Pontoon LED Flat Flexible Ribbon LED Strip Light Kit – RGB Color Changing.....59
Large 3-Finger Lid Lift.....7	LED Spreader Lights.....50-51
Latches, Earth Magnetic.....2	Oval Recessed Mount Spreader LED Light.....50
Latches, Gate.....83, 84	LED Super Spreader Light.....50
Latches, Large Lid Slam.....2	LED Mini Spreader.....51
Latches, Lid.....2	LED Side Docking Light.....51
Launch Cord – Z-Launch™.....73	Recessed Flush Mount LED Spreader Light.....51
<b>LED LIGHTING – AQUA-BLAZE.....47-73</b>	LED Underwater Lights.....48-49
LED Battery Operated.....71	Premium LED Underwater Light.....48
LED Flex Strip Lights – Battery Operated.....71	High Output Underwater LED Fishing Light.....48
Battery Operated Slim Line Lights.....71	High Intensity LED Underwater Lights.....48
Battery Operated LED Strip Light Accent Kit Pairs.....71	Underwater LED Light with Stainless Steel Bezel.....48
LED Courtesy Lights.....64-70	Fully Encapsulated Underwater LED Light.....49
Stainless LED Puck Lights.....64	Stainless Steel Oval LED Underwater Light.....49
Recessed LED Puck Lights.....64	Extreme LED Underwater Light.....49
LED Surface Mount Dome Light.....64	Lever Tie Down.....80
Push-In LED Utility Light.....65	Lid Accessories.....2-7
Mini LED Dual Mount Courtesy Light.....65	Lid Latches.....2
LED Push-In Cockpit Light.....65	Lid Lifts.....7
Livewell/Courtesy Lights LED.....65	Lid Lifts – Large 3-Finger.....7
Flush Head LED Livewell Lights.....65	Lid Locks.....2
LED Companion Way Lights.....66	Lid Pull/Floor Drain Combo.....29
LED Oval Courtesy Lights.....66	Lid Spring.....6
LED Courtesy Companion Way Light.....66	Lid Strap.....7
LED Mini Accent Light.....67	Lifts, Lid.....7
Courtesy/Accent LED Light.....67	Light Clips.....77
LED Oblong Courtesy Lights.....67	Light Kits, LED.....56-57
Slim Line LED Utility Strip Lights.....68	Lights, Courtesy.....64-70
LED Rail Light.....68	Lights, Mounting Brackets.....78
Mini Stick-On LED Light.....68	Lights, LED.....47-73
LED Round Companion Way with Eyebrow Accent Slit.....69	Linear Lighting, LED.....60-63
LED Module Courtesy Lights – Single, Triple or Quad.....69	Liners, Hatch.....5
Stainless Steel Indirect LED Courtesy Light.....70	Livewell Aeration.....20
Low Profile Stainless Steel LED Dome Light.....70	Livewell Drain Tubes.....27
High Intensity Oval LED Courtesy Light/Rock Light.....70	Livewell Fitting, Directional.....23, 24
LED Cups & Speakers.....72	Livewell Lights – LED Models.....65
LED Lighted Stainless Steel Rim Drink Holder.....72	Livewell Overflow / Utility Storage Clips.....29
Cup Holder LED Accent Ring.....72	Livewell Treatment Solutions.....18, 19
LED Cup Holder Insert.....72, 79	Loc-R-Bar™ Boat Security System.....76
	Locks, Lid.....2





Low Clearance Thru-Hull.....32  
 Lure Holders .....100, 101  
 Lure Retriever, The Money Pole™ .....88

**M-N-O**

Manifold System Parts.....34  
 Marine Audio Technology – HydroWave..... 89-97  
 Max-Air™ Venturi Aerator.....20  
 Mini-Jacker™.....12  
 Molded Rod Racks.....37  
 Money Pole™ Lure Retriever .....88  
 Motor Stik™ - Outboard Motor Support.....77  
 Motor Support, Evinrude G2.....77  
 Mount – KVD Kong™ Extreme Electronics Mount .....98  
 Mount – Shock-Lock™ Mini Kong™ Electronics Mounts.....99  
 Mount, Steering Console.....80  
 Mount, Throttle Control.....85  
 Mounts, Cooler.....80  
 Mr.Crappie® Bait Blaster Underwater Light.....19  
 Mr.Crappie® Crappie Care.....19  
 Navigation Light Clips.....76  
 Navigation Lights, LED .....52-55  
 Nozzles, Wash Down.....87  
 Organizer, Rod Storage.....35  
 Oetiker® Hose Clamps.....44  
 Oetiker® Hose Clamp Kit.....44  
 Oetiker® Steplless® Ear Hose Clamps.....44  
 Outboard Flush Kits.....77  
 Oval Courtesy Light w/Switch, Incandescent .....66  
 Oval Deck Plates.....6  
 Oval Grommet.....46  
 Overflow Drain Thru-Hull.....28  
 Overflow Drain Tubes.....28  
 Overflow Fittings.....28  
 Oxygenator™, Pro Live Well.....17

**P-Q**

Paddle Keeper .....81  
 Peddle Paddle.....103  
 Pedestal Base Plug.....37  
 Pedestal Holders.....37

**PERFORMANCE.....8-16**

Pickup, Water.....20, 21  
 Plates, Jacking.....8-12  
 Plug, Drain.....28  
 Plug, Pedestal Base.....37  
 Plug, Push-In.....28  
 Plug, Thru-Hull.....28  
 Plumming Fittings.....33

**PLUMBING & DRAIN.....17-34**

Pontoon Door Stops.....83  
 Pontoon Fender Hanger Clips.....84  
 Pontoon Finger Guard.....84  
 Pontoon Gate Holder.....84  
 Pontoon Gate Latch.....83  
 Pontoon LED Light Kits.....58-59  
 Pontoon Rail Shims.....84  
 Pontoon Splash Guard Deflector.....84  
 Pro-Air System.....20  
 Pro Hi-Jacker Jack Plates.....12  
 Pro Live Well Oxygenator™.....17  
 Prop Nut, G-Force Eliminator™.....38  
 Prop-Stop™ Spare Prop Retainer.....80  
 Prop-Master Wrench.....87  
 Propeller Retainer, Prop-Stop™.....80  
 Propeller Wrench.....87  
 Pump Bracket.....22  
 Push-In Aerator Screens.....30  
 Push-In Drain.....27

Push-In Plug for Drains.....28  
 Quick Flush, Outboard Flush Kit.....77  
 Quick Release Deck Plates.....5

**R**

Radiused Cable Ties.....43  
 Rail Shims, Pontoon.....84  
 Reboarding Ladder.....13  
 Recessed Scupper Drain.....26  
 Reducer Fittings, Manifold.....34  
 Reducing Tee Fittings.....33  
 Remote Seacock Arm.....31  
 Retriever, Anchor.....87  
 Reverse Transom Wedge – 1 Pair.....15

**RIGGING.....42-46**

Rigging Flange.....43  
 Rigging Flange, Chrome Plated.....43  
 Rigging Flange, Tri-Shape.....43  
 Rigging Flange Hose Union.....43  
 Rigging Flange w/Fuel Port.....43  
 Rigging Hoses.....43  
 Rigging Sleeve, Zippered.....42  
 Rod Grommets.....36  
 Rod Hold-Down Strap.....36  
 Rod Holder Drain Caps.....36  
 Rod Holders.....37

**ROD ORGANIZATION.....35-37**

Rod Racks.....37  
 Rod Racks, Molded.....37  
 Rod Security System.....36  
 Rod Storage Holders, Foam.....35  
 Rod Storage Organizers.....35, 37  
 Rod Storage Tubes.....35  
 Rod Tamer™ Rod Straps.....36  
 Rod Tube End.....36  
 Rope Grommet.....46  
 Rub Rail Fittings.....86

**S**

Saf-T-Stop™ Ignition Kill Switches.....16  
 Scoop, Water Pickup.....20  
 Screen Cleaning Kit.....98  
 Screen, Aerator.....30  
 Screen, Drain.....30  
 Screw Down Plates - Designer Series.....6  
 Scupper, Adapters.....25  
 Scupper, Ball.....25  
 Scupper Drain.....25, 26  
 Scupper, Duckbill.....26  
 Scupper, Flapper-Type.....25-26  
 Scupper, Inline.....25  
 Scupper, Recessed Thru-Hull.....26  
 Scupper, Recessed Thru-Hull Chrome.....26  
 Scupper, Repair Kit.....26  
 Scupper, Transom Drain, Flat Bottom.....26  
 Seat Pedestal Drain.....27  
 Seacock Remote Arm.....31  
 Security System, Loc-R-Bar™.....76  
 Shims, Pontoon Rail.....84  
 Shock Cord.....83  
 Shock-Lock™ Dual Kong™.....99  
 Shock-Lock™ Mini-Kong™ Electronics Mount.....99  
 Skeg, Replacement.....15  
 Slam Latch – Large Deck Lids.....2  
 Sleeves, Zippered Rigging.....42  
 Sleeving, Flex.....42  
 Spacers, Transom.....14  
 Spanner Head Thru-Hull.....32  
 Spare Propeller Retainer.....80







# Part Number Index

PART #	PAGE	PART #	PAGE	PART #	PAGE	PART #	PAGE
004B-C.....	43	16700012.....	44	APD-1.....	27	CBR-2.....	46
004B-M.....	43	16700013.....	44	APD-1F.....	27	CBR-4.....	46
007B-C.....	43	16700016.....	44	APD-2.....	27	CLEAT-4.5.....	86
007B-M.....	43	16700017.....	44	APD-118.....	27	CLEAT-6.....	86
008B-C.....	43	16700020.....	44	APD-190.....	27	CLEAT-8.....	86
008B-M.....	43	16700024.....	44	APD-190F.....	27, 32	CLEAT-10.....	86
011B-C.....	43	16700031.....	44	APD-190FT.....	23	CMK-1-DP.....	80
011B-M.....	43	16700034.....	44	APD-290.....	27	CS-1.....	46
014B-C.....	43	16700040.....	44	APD-290F.....	27, 32	CS-1SS.....	46
014B-M.....	43	16705000.....	44	APS-1.....	80	CS-2.....	46
055B-C.....	43	16705989.....	44	AR-0-DP.....	87	CS-SS-3.....	46
055B-M.....	43	18500000.....	44	AR-ON-DP.....	87	CSD-90.....	25
075B-RAD-C.....	43	AAC-1-DP.....	20	AR-1-DP.....	87	CSD-92.....	25
075B-RAD-M.....	43	AF-1.....	30	AR-1N-DP.....	87	CSD-92W0.....	25
145B-C.....	43	AFD-118.....	29	ARO-1-DP.....	87	CSS-1.....	46
7014G.....	10	AFD-118P.....	29	AS-1.....	30	CSS-1SS.....	46
13001.....	110	AFD-2.....	29	AS-2.....	30	CSS-2.....	46
13002.....	110	AFM-1.....	30	ASM-5.....	30	DAH-45.....	23
13022.....	110	AH-1.....	24	AUC-2.....	87	DAH-90.....	23
13032.....	110	AH-90.....	24	AUC-9.....	87	DAHI-118.....	23
20000.....	105	AH-92.....	24	AUC-2PR-DP.....	87	DAHIK-118.....	23
20022.....	15, 105	AHJ-4V-DP.....	8	AUC-9PR-DP.....	87	DAHIK-750-DP.....	23
20032.....	15, 105	AHJ-4VHD-DP.....	9	BBC-1.....	41	DBAS-1W.....	27
20122.....	15, 106	AHJ-6V-DP.....	8	BBC-1P.....	41	DBBS-1G.....	27
20220.....	106	AHJ-6VHD-DP.....	9	BCORD-14B.....	83	DBBS-1W.....	27
20320.....	106	AHJ-8V-DP.....	8	BCORD-14BW.....	83	DBH-27P.....	82
40012.....	107, 108	AHJ-8VHD-DP.....	9	BDS-1115-9-DP.....	3	DBH-27-SC.....	82
50012.....	108	AHJ-10V-DP.....	8	BDS-1324-12-DP.....	3	DBS-2B.....	25
52100.....	110	AHJ-10VHD-DP.....	9	BH-24P.....	82	DLSL-1N.....	2
55012.....	107, 108	AHJ-12V-DP.....	8	BH-27P.....	82	DLSL-1S.....	2
61001.....	106	AHJ-12VHD-DP.....	9	BH-31P.....	82	DP-1.....	30
61002.....	106	AHJ-14V-DP.....	8	BH-24S.....	82	DP-1FS.....	30
61012.....	107, 108	AHJ-14VHD-DP.....	9	BHF-27S.....	82	DP-2.....	30
61301.....	105	AHJACT-3-DP.....	8	BHF-31S.....	82	DPCAM-6-X.....	5
61302.....	105	AHJHSP-4V-DP.....	10	BK-1-DP.....	12	DPCAM-8-X.....	5
65001.....	106	AHJHSP-6V-DP.....	10	BS-1.....	81, 82	DPOVAL-6D-X.....	5
65002.....	108, 110	AHJHSP-8V-DP.....	10	BS-1-42SS.....	81, 82	DPP-6-X.....	5
65012.....	109	AHJHSP-10V-DP.....	10	BSK-1SS.....	80, 81	DPP-8-X.....	5
65201.....	106, 108	AHJHSP-12V-DP.....	10	BSR-1-FH.....	42	DPS-4-X.....	5
65212.....	107, 108	AHJHSP-14V-DP.....	10	BSR-1K.....	42	DPS-6-X.....	5
65213.....	108	AHJHSP-T-8V-DP.....	10	BSR-1K-CB.....	42	DPS-8-X.....	5
65301.....	106	AHJHSP-T-12V-DP.....	10	BWF-1.....	30	DPSLP-4-X.....	5
65302.....	106	AHJM-4-DP.....	10	BWK-2.....	21	DPSLP-4S-X.....	5
70012.....	108	AHJM-CMA-DP.....	10	CAM-ZA.....	2	DPSLP-5-X.....	5
90012.....	108	AHJRELAYKIT-2-DP.....	8	CAM-ZCXL.....	2	DPSLP-5S-X.....	5
14100387.....	44	AHJSWITCH-1-DP.....	8	CB-1.....	46	DPSLP-6-X.....	5
14100396.....	44	AHV-1.....	24	CB-1FW.....	46	DPSLP-8-X.....	5
15500000.....	44	AHV-90.....	24	CB-1W.....	46	DRS-1.....	7
15500001.....	44	AHV-92.....	24	CB-2.....	46	DRS-1HD.....	7
15500003.....	44	AHV-1890.....	24	CB-2FW.....	46	DRS-4.....	7
15500006 THRU 15500024.....	44	AHVWD-90.....	22, 24	CB-2W.....	46	DRS-5.....	7
15500030 THRU 15500033.....	44	AHVWD-92.....	22, 24	CB-4.....	46	DRS-7.....	7
15500070.....	44	AL-1.....	2	CB-4FW.....	46	DRS-9.....	7
16700001.....	44	AL-2.....	2	CB-4W.....	46	DRS-16.....	7
16700004.....	44	ALC-1.....	2	CBBK-1-DP.....	41	DRS-16HD.....	7
16700006.....	44	ALC-2.....	2	CBG-1.....	45	DRS-20.....	7
16700007.....	44	ALCN-1.....	2	CBG-2.....	45	DS-1L.....	83
16700010.....	44	ALCN-2.....	2	CBG-4.....	45	DS-1LB.....	83
16700011.....	44	ALS-1.....	2	CBR-1.....	46	DS-1R.....	83



<b>PART #</b>	<b>PAGE</b>	<b>PART #</b>	<b>PAGE</b>	<b>PART #</b>	<b>PAGE</b>	<b>PART #</b>	<b>PAGE</b>
DS-1RB.....	83	FSG-1XL.....	85	HDSS-1119-X.....	3	JP-ADJ-BOLT.....	12
DS-2L.....	83	FSG-2.....	85	HDSS-1119-X-REM.....	3	JPZ-4-DP.....	11
DS-2LB.....	83	FSG-2XL.....	85	HDSS-1317-X.....	3	JPZ-6-DP.....	11
DS-2R.....	83	FSG-3.....	85	HDSS-1317-X-REM.....	3	JPZ-8-DP.....	11
DS-2RB.....	83	FSG-3XL.....	85	HDSS-1324-X.....	3	JPZ-10-DP.....	11
DSSDP-1-1.....	6	FSG-7.....	85	HDSS-1324-X-REM.....	3	JPZ-12-DP.....	11
DSSDP-1-2.....	6	FSG-7C.....	85	HDSS-1330-X.....	3	JPZHSP-6.....	11
DSSDP-2-1.....	6	FSG-8C.....	85	HDSS-1620-X.....	3	JPZHSP-8.....	11
DSSDP-2-2.....	6	FSG-10.....	85	HDSS-1620-"X"LV.....	4	JPZHSP-10.....	11
DSSDP-4-2.....	6	FSG-10XL.....	85	HDSSL-0714-X.....	3	JPZHSP-12.....	11
DWC-1.....	45	FSRK-1-DP.....	26	HDSSL-1115-X.....	3	KEY-2.....	2
EBL-1.....	13	GDP-1CB.....	28	HDSSL-1119-X.....	3	KS-1.....	16
EBL-1-DP.....	13	GDSS4-0714-X.....	3	HDSSL-1317-X.....	3	KS-2.....	16
EBL-2-DP.....	13	GDSL4-0714-1.....	3	HDSSL-1324-X.....	3	KS-12.....	16
EBL-3-DP.....	13	GFC-1-DP.....	88	HDSSL-1330-X.....	3	KS-22.....	16
EC-150N.....	85	GFEL-MG-BK-DP.....	39	HDSSL-1620-X.....	3	L-4-DP.....	16
ECMW-2.....	85	GFEL-MG-BU-DP.....	39	HF-1-DP.....	14	LB-ADAPTER/1A.....	76
ECR-1.....	85	GFEL-MG-C-DP.....	39	HF-1CT-DP.....	14	LB-LRBS113S.....	76
ECR-2.....	85	GFEL-MG-R-DP.....	39	HF-1T-DP.....	14	LB-LCK110DBA.....	76
ELCT0163.....	10	GFEL-MK-BK-DP.....	39	HFM-1.....	14	LB-SET-BKS-03A-03B.....	76
EJT-1-DP.....	14	GFEL-MK-BU-DP.....	39	HFS-1-DP.....	14	LB-TLR LCK.....	76
ELL-3/4.....	33	GFEL-MK-C-DP.....	39	HLB-1-DP.....	76	LCH-1.....	78
ELL-118.....	33	GFEL-MK-R-DP.....	39	HS-1.....	6	LCH-ISR.....	79
EYE-1.....	83	GFEL-MKS-BK-DP.....	39	HT-1.....	13	LCH-ISRREM.....	79
EYESS-1.....	83	GFEL-MKS-BU-DP.....	39	HW-100038-11P.....	90	LCH-1SS.....	78
EZ-BLK-1.....	21	GFEL-MKS-C-DP.....	39	HW-ASSY-2.0BAG.....	97	LCH-1W.....	78
EZ-WHT-1.....	21	GFEL-MKS-R-DP.....	39	HW-ASSY-2.0SPKR.....	97	LCH-2.....	78
EZ-SND-1.....	21	GFES-RED-DP.....	39	HW-ASSY-MINI12VK.....	97	LCH-DKS-1.....	79
EZ-BLK-2.....	21	GFES-BLK-DP.....	39	HW-BKT-SPKRTRM.....	97	LCH-DKS-2.....	79
EZ-WHT-2.....	21	GFEQ-MG-BK-DP.....	39	HW-EXP-BAIT.....	93	LCH-52012.....	78
FA-3/4.....	33	GFEQ-MG-BU-DP.....	39	HW-EXP-BREAM.....	93	LCH-52016.....	78
FA-90.....	33	GFEQ-MG-R-DP.....	39	HW-EXP-CRAW.....	93	LED-319DL.....	51
FAGK-1-DP.....	10	GFH-1G-DP.....	40	HW-EXP-HERR.....	93	LED-1404.....	65
FAGK-2-DP.....	10	GFH-1R-DP.....	40	HW-EXP-KVD.....	93	LED-32648.....	70
FAGK-1SS-DP.....	10	GFH-CA1R-DP.....	39, 40	HW-EXP-MRCRP.....	95	LED-32650.....	70
FAGK-2SS-DP.....	10	GH-1G.....	84	HW-EXP-STRIP.....	93	LED-32650-2KT.....	57
FCH-1.....	80	GHB-1.....	88	HW-PKG-2.OBOAT.....	97	LED-32650-6KT.....	57
FCS-1.....	41	GHB-1-SS.....	88	HW-PKG-H2CAT.....	92	LED-32651.....	70
FCS-2.....	41	GHB-1FW.....	88	HW-PKG-H2CRAP.....	94	LED-32651-2KT.....	57
FD-2.....	28	GHB-1G-SS.....	88	HW-PKG-H2KVD.....	89	LED-32651-6KT.....	57
FD-2W.....	28	GHB-1T.....	88	HW-PKG-H2MRCRAP.....	95	LED-33240.....	70
FD-4.....	28	GL-1.....	83	HW-PKG-H2WALL.....	92	LED-33241.....	70
FD-4W.....	28	GL-2.....	83	HW-PKG-ICEMINI.....	96	LED-33242.....	70
FDP-4WS.....	28	GT-1.375-"X".....	35	HW-PKG-INSW.....	91	LED-33249.....	70
FF-150.....	28	GT-1.700-"X".....	35	HW-PKG-MINI.....	96	LED-33250.....	70
FFTB-1-DP.....	13	GT-2.250-"X".....	35	HW-PKG-MINICAT.....	96	LED-33251.....	70
FG-150.....	24	HAT-1115-X.....	4	HW-PKG-MINICRAW.....	96	LED-33253.....	70
FLX-25-DP.....	42	HAT-1324-X.....	4	HW-PKG-MINIWALL.....	96	LED-33253-2KT.....	57
FLX-50-DP.....	42	HATL-1115-X.....	4	HYD-1-DP.....	16	LED-33253-6KT.....	57
FLX-75-DP.....	42	HATL-1324-X.....	4	ILS-750.....	25	LED-33255.....	70
FLX-125-DP.....	42	HC-4.....	45	ILS-1200.....	25	LED-33255-2KT.....	57
FLX-150-DP.....	42	HC-6.....	45	ILS-1500.....	25	LED-33255-6KT.....	57
FLX-200-DP.....	42	HC-8.....	45	IPD-580.....	27	LED-33256.....	70
FLXB-25.....	42	HC-10.....	45	IPD-582.....	27	LED-33256-2KT.....	57
FLXB-50.....	42	HC-12.....	45	IPD-1000.....	27	LED-33256-6KT.....	57
FLXB-75.....	42	HC-16.....	45	IPD-1000-5.....	27	LED-33257.....	70
FLXB-125.....	44	HC-24.....	45	IPD-1002.....	27	LED-33257-2KT.....	57
FLXB-150.....	42	HC-28.....	45	JP-1A-DP.....	12	LED-33257-6KT.....	57
FLXB-150FR.....	42	HDSS-0714-X.....	3	JP-4FA-DP.....	12	LED-33267.....	62
FMS-1-0.....	25	HDSS-1013-X-REM.....	3	JP-4FAHD-DP.....	12	LED-33268.....	62
FRH-1P-DP.....	35	HDSS-1115-X.....	3	JP-6PW-DP.....	12	LED-33269.....	62





PART #	PAGE	PART #	PAGE	PART #	PAGE	PART #	PAGE
LED-33270.....	62	LED-39277.....	62, 71	LED-51857.....	68	LED-LPBNAVC-1.....	52
LED-33271.....	62	LED-39306-DP.....	53	LED-51858.....	68	LED-NAV-39522.....	54
LED-33272.....	62	LED-39308-DP.....	71	LED-51866.....	48	LED-NAV-39526.....	54
LED-33273.....	62	LED-39310-DP.....	71	LED-51867.....	48	LED-NAV-39524.....	54
LED-33274.....	62	LED-39312-DP.....	71	LED-51868.....	48	LED-NAV-39525.....	54
LED-33275.....	62	LED-39320.....	62	LED-51874.....	65	LED-NAV-39762.....	54
LED-33276.....	62	LED-39321.....	62	LED-51875.....	65	LED-NAVSFSB.....	55
LED-33277.....	62	LED-39322.....	62	LED-51876.....	66	LED-NAVSFSL-48.....	55
LED-33278.....	62	LED-39323.....	62	LED-51880.....	65	LED-OCL-1.....	66
LED-33279.....	62	LED-39328.....	62	LED-51891.....	66	LED-OCL-1K-DP.....	66
LED-33280.....	62	LED-39329.....	62	LED-51894.....	66	LED-OCL-2.....	66
LED-33281.....	62	LED-39330.....	62	LED-51897.....	64	LED-OCL-2K-DP.....	66
LED-33282.....	62	LED-39331.....	62	LED-51898.....	65	LED-PBDK20B-DP.....	59
LED-33308.....	70	LED-39503.....	54	LED-51899.....	66	LED-PBDK20RGB-DP.....	59
LED-33308-2KT.....	57	LED-39507.....	54	LED-51900.....	48	LED-PBDK25B-DP.....	59
LED-33308-6KT.....	57	LED-39509.....	54	LED-51901.....	48	LED-PBDK25RGB-DP.....	59
LED-33309.....	70	LED-39510.....	54	LED-51905.....	51	LED-RGBCONT-1.....	61
LED-33309-2KT.....	57	LED-39513.....	54	LED-51913.....	51	LED-RKAW-6KT.....	57
LED-33309-6KT.....	57	LED-39532.....	62	LED-51914.....	50	LED-RKBW-6KT.....	57
LED-33990.....	49	LED-39533.....	62	LED-51946.....	60	LED-RKGW-6KT.....	57
LED-33991.....	49	LED-39536.....	62	LED-51947.....	60	LED-RKRW-6KT.....	57
LED-33992.....	49	LED-39537.....	62	LED-51948.....	60	LED-RLC.....	60
LED-33993.....	49	LED-39538.....	62	LED-51949.....	60	LED-RLC-WT.....	60
LED-34154.....	48	LED-39540.....	64	LED-51950.....	60	LED-ROPKIT-X.....	61
LED-34160-DP.....	58	LED-39670-DP.....	71	LED-51951.....	60	LED-SM14-B.....	61
LED-34180.....	69	LED-39672-DP.....	71	LED-51952.....	60	LED-SM14-W.....	61
LED-34181.....	69	LED-39685.....	63	LED-51953.....	60	LED-SM16-B.....	61
LED-34182.....	69	LED-39686.....	63	LED-51954.....	60	LED-SM16-RGB.....	61
LED-34183.....	69	LED-39687.....	63	LED-51955.....	60	LED-SM16-W.....	61
LED-34185.....	69	LED-39688.....	63	LED-51956.....	60	LED-SM18-B.....	61
LED-34186.....	69	LED-39690.....	51	LED-51957.....	60	LED-SM18-W.....	61
LED-34187.....	69	LED-39691.....	51	LED-51959.....	60	LED-SM20-B.....	61
LED-34188.....	69	LED-39757.....	54	LED-51961.....	60	LED-SM20-RGB.....	61
LED-34189.....	69	LED-39758.....	54	LED-51963.....	60	LED-SM20-W.....	61
LED-34190.....	69	LED-39759.....	54	LED-51965.....	60	LED-SM22-B.....	61
LED-39024.....	67	LED-39771.....	54	LED-51966.....	60	LED-SM22-W.....	61
LED-39027.....	67	LED-39772.....	54	LED-51977.....	65	LED-SM24-B.....	61
LED-39034.....	67	LED-51800.....	68	LED-51978.....	65	LED-SM24-W.....	61
LED-39050.....	66	LED-51801.....	68	LED-52000-DP.....	53	LED-SM25-RGB.....	61
LED-39055.....	48	LED-51803.....	68	LED-59265.....	63	LED-SM26-B.....	61
LED-39060.....	48	LED-51805.....	68	LED-59266.....	63	LED-SM26-W.....	61
LED-39061.....	48	LED-51806.....	68	LED-59267.....	63	LED-SM28-B.....	61
LED-39062.....	48	LED-51810.....	68	LED-59268.....	63	LED-SM28-W.....	61
LED-39072.....	68	LED-51811.....	68	LED-BNAVC-1.....	52	LED-SM7815-W.....	49
LED-39073.....	68	LED-51816.....	66	LED-BTKIT-BLUE.....	56	LED-SM7815-B.....	49
LED-39094.....	50	LED-51818.....	66	LED-BTKIT-GREEN.....	56	LED-SM7815-G.....	49
LED-39100.....	69	LED-51819.....	66	LED-BTKIT-RED.....	56	LED-SM7815-RGB.....	49
LED-39101.....	69	LED-51820.....	66	LED-BTKIT-WHITE.....	56	LED-SM171COB-W.....	49
LED-39116.....	67	LED-51822.....	66	LED-BTSL-24.....	55	LED-SM172COB-B.....	49
LED-39117.....	67	LED-51823.....	67	LED-BTSL-36.....	55	LED-SM173COB-G.....	49
LED-39120.....	50	LED-51824.....	67	LED-CHI-W.....	72, 78	LED-SMCHR-B.....	72
LED-39122.....	50	LED-51825.....	67	LED-CHI-B.....	72, 78	LED-SMCHR-G.....	72
LED-39112SB.....	50	LED-51827.....	64	LED-CHI-R.....	72, 78	LED-SMCHR-R.....	72
LED-39216.....	67	LED-51828.....	64	LED-CHI-G.....	72, 78	LED-SMSKR-B.....	72
LED-39217.....	67	LED-51829.....	64	LED-CHI-RGB.....	72, 78	LED-SMSKR-G.....	72
LED-39218.....	67	LED-51830.....	64	LED-LCH-BU.....	72, 78	LED-SMSKR-R.....	72
LED-39224.....	67	LED-51831.....	64	LED-LCH-G.....	72, 78	LED-SMSKR-5B.....	72
LED-39254.....	67	LED-51832.....	64	LED-LCH-R.....	72, 78	LED-SMSKR-5G.....	72
LED-39255.....	67	LED-51847.....	64	LED-LCH-W.....	72, 78	LED-SMSKR-5R.....	72
LED-39275.....	62, 71	LED-51848.....	64	LED-LPNAV-1.....	52	LED-SMSLC-6WT.....	61
LED-39276.....	62, 71	LED-51849.....	64	LED-LPNAV-2.....	52	LED-SMSLC50-4WT.....	61

PART #	PAGE	PART #	PAGE	PART #	PAGE	PART #	PAGE
LED-TMHL-DP	41	ODT-1	29	RFS-1	26	SDP-1FW	6
LED-TRLKIT-BLUE	56	ODT-1-12-GSTW	29	RFS-2	26	SDP-2	6
LED-TRLKIT-GREEN	56	ODT-1-12-TW	29	RFT-1	43	SDP-2FW	6
LED-TRLKIT-RED	56	ODT-190	29	RFT-1XS	26	SDP-2W	6
LED-TRLKIT-WHITE	56	ODT-2	29	RFT-2B	26	SDP-3	6
LED-UV24-DP	63	ODT-2T	29	RFT-2BCP	23, 26	SDP-3FW	6
LED-UV24TRK-DP	63	ODT-290	29	RFT-2XS	26	SEACOCK-15.5	31
LL-1	7	ODTS-1	29	RG-1	46	SEACOCK-18.5	31
LLR-1	7	ODTS-2	29	RH-1	37	SEACOCK-24	31
LRS-2-DP	25	OG-1	46	RH-1FW	37	SEACOCK-36	31
LS-2	7	OGL-1	46	RH-2	37	SEACOCK-40	31
LS-2C	7	PAP-1	20	RH-2FW	37	SEL-1-DP	53
LS-3	7	PAS-1	20	RH-2W	37	SEL-1LED-DP	53
LV-1	28	PAS-2	20	RH-3FW	37	SKDK-BW36-DP	99
LWL-1P-LED	65	PB-90	22	RH-3W	37	SKDK-BW37-DP	99
LWLM-1P-LED	65	PBP-1	37	RH-4	37	SKDK-BW38-DP	99
LWLM-1P-LED-BLUE	65	PCORD-14B	83	RH-5	37	SKDK-BW39-DP	99
MAGHL-2-DP	2	PD-1	27	RH-5W	37	SKDK-BW48-DP	99
MAV-2	20	PD-2	27	RHBD-1	36	SKDK-BW49-DP	99
MAV-2K	20	PDS-1	84	RHBD-2SS	36	SKDK-BW50-DP	99
MAV-2KT	20	PEDP-1-DP	103	RHBD-2SST	36	SKDK-BW56-DP	99
MAV-FACEPLATE	20	PFAC-1	84	RHD-1	36	SKDK-BW57-DP	99
MJ-1-DP	12	PFH-1G	84	RHD-2	36	SKDK-BW58-DP	99
MP-1	88	PFPG-1G	84	RHDN-1	36	SKDK-BW59-DP	99
MS-3A100	34	PFPG-1LB	84	RHDN-2	36	SKDK-BW60-DP	99
MS-3A112	34	PH-1	42	RHRB-3B	37	SKDK-BW61-DP	99
MS-3A10034	34	PH-2	42	RHRM-2B	37	SKDK-BW62-DP	99
MS-3A11434	34	PH-3	42	RHRM-2W	37	SKLK-KONG-1-DP	98
MS-3EL34	34	PH-3FW	42	RHRM-3B	37	SKLK-LAST-DP	99
MS-3EL100	34	PH-3FWGT-"X"	35	RHRM-3W	37	SKLK-NAST-DP	99
MS-3EL1234	34	PH-3S	42	RHRFW-3FW	37	SKLK-SAST-DP	99
MS-3M100	34	PH-3SGT-"X"	35	RHRW-3W	37	SKTM-BK-DP	98
MS-3M114	34	PH-30	36	RHS-3B	37	SKTM-R-DP	98
MS-3RB10034	34	PK-1-DP	81	RHS-3FW	37	SMEC-1	86
MS-3RB11234	34	PL-65	106	RHSF-3B	37	SPA-250B	84
MS-3TT34	34	PL-65HS	105	RHSF-3FW	37	SPA-250G	84
MS-3TT100	34	PL-65SS	106	RHSF-3W	37	SPA-375B	84
MS-3TT112	34	PL-65-10	106	RHSF-3W	37	SPA-375G	84
MS-EG2-DP	77	PL-65-10HS	105	RMC-101MG-DP	40	SPA-500B	84
MSS-1	77	PMW-1	87	RMC-101MK-DP	40	SPA-500G	84
NBH-247P	81	PP-118	27, 28	RMC-101FMK-DP	40	SPA-500-LB	84
NBH-24P	83	PP-125	28	RMC-104FMK-DP	40	SPD-1	27
NBH-27P	83	PP-150	28, 31	RMC-105FMK-DP	40	SR-1	86
NBH-31P	83	PRR-1	80	RMC-108-DP	39, 40	SS-1-DP	76
NBH-24S	83	PT-35	111	RMC-109-DP	39, 40	ST-1-DP	13
NBH-27S	83	PT-130	111	RS-1-DP	15	STRAP-12BWS	80
NBH-31S	83	PWRBX-12V	102	RS-2-DP	15	SWD-1	27
NBH-24-SSC	82	QF-1K-DP	77	RS-3-DP	15	SWD-1W	27
NBH-27-SSC	82	QF-2K-DP	77	RS-4-DP	15	SWD-3	27
NBH-31-SSC	82	RF-1	43	RT-14	36	SWD-3W	27
NBH-31-SSC-OPT	81	RF-1CP	23, 43	RT-18	36	SWD-3WCP	27
NFSL-5-1	2	RF-2	43	RTHOOK-1	83	SWD-4W	27
NFSL-5-2	2	RF-2.5-1	43	RTSM-1	83	SWD-4WCP	27
NRL-1	2	RFFHP-1	43	RUSC-1	29, 76	SWD-5	27
NRL-2	2	RFFHP-2	43	SA-1	26	T-1	20
O2-BK3-DP	17	RFH-1	43	SA-2	26	TAB-1	16
O2-BKM3	17	RFH-2	43	SA-2B	26	TBOX-1115-3T-X	4
OCL-1	66	RFH-2.5-1	43	SA-3	26	TC-1-DP	77
OCL-2	66	RFHU-1	43	SCB-527	31	TCM-1-DP	85
OCLR-1	66	RFK-1-DP	43	SCM-2-DP	85	TD-54778	80
OCLR-2	66	RFK-1CP-DP	43	SDP-1	6	TDSS-0714-2T-"X"	4





PART #	PAGE	PART #	PAGE	PART #	PAGE	PART #	PAGE
TDSS-1115-3T-"X"	4	TH-1292	32	TT-CGTS1-DP	101	WDSW-"X"- "Y"	86
TDSS-1317-4T-"X"	4	TH-1292S	32	TT-CGTS2-DP	101	WDV-1	22
TE-1	36, 42	TH-1500AFD	31	TT-MINI1-DP	100	WDV-1CP	22
TE-1FWGT-"X"	35	TH-1500CP	23	TT-MINI2-DP	100	WDV-90	22
TE-3FWGT-"X"	35	TH-1500XL	32	TT-TITANI1-DP	100	WHH-1	45
TE-1GT-"X"	35	TH-1500XLCP	23	TT-TITAN2-DP	100	WHH-1KIT-DP	45
TE-1SGT-"X"	35	TH-1500XS	32	TT-TLMAN1-DP	101	WS-1	20
TE-3SGT-"X"	35	TH1500XSFAFD	31	TT-TLMS1-DP	101	WSH-1	81
TE-1FW	36	TH-1502F	28	TTC-1	13	WSH-1F	81
TE-1S	36, 42	TH-1502FF	26	TTEC-1	86	Y-118	33
TE-1W	36, 42	TH-1502G	24	TW-2	15	Y-750	33
TEC-1	86	TH-1502S2	32	TW-3	15	YO-ASPV1	75
TEC-1L	86	TH-1502S2N	32	TWA-1-DP	76	YO-ASV1	75
TEC-1R	86	TH-1502T	29	TWA-DIS-5	76	YO-PSV1	74
TEE-112	33	TH-1502XL	32	TWAR-1-DP	76	ZL-10-DP	73
TEE-118	33	TH-1502XS	32	U21-FW	18	ZL-15-DP	73
TEE-150	33	TH-1590	32	U28-FW	18	ZL-20-DP	73
TEE-250	33	TH-1590AFD	31	U216-FW	18	ZRS-1	42
TEE-350	33	TH-1590CP	23	U264-FW	18		
TEE-3/4	33	TH-1592	32	U216-SW	18		
TEE-3/8	33	TH-1592F	28	U264-SW	18		
TEE-5/8	33	TH-1592G	24	U2CI-FW	19		
TEO-2.50	37	TH-1592T	29	U2C8-FW	19		
TEO-2.50-1-"X"	35	TH-1890	32	U2C64-FW	19		
TEO-2.50-2-"X"	35	TH-1890CP	23	U2C128-FW	19		
TEO-2.50-3-"X"	35	TH-1890T	23, 29	U2.3FW-12PK	18, 19		
TEO-2.50-Y-X	35	TH-1892	32	UC-1	29		
TEO-3.00-1-"X"	35	TH-1992	24	UG-1	36, 46		
TEO-3.00-2-"X"	35	TH-1992BHS	24	UG-1W	36, 46		
TEO-3.00-3-"X"	35	TH-1992FH	24	UG-1FW	36, 46		
TEO-3.00-Y-X	35	TH-1992FHR	24	UG-2	48		
TH-1	32	TH-1992FHS	24	UG-2FW	46		
TH-1XL	32	TH-1992R	24	UG-2W	36, 46		
TH-3S	32	TH-1992S	24	UG-3	48		
TH-90	32	TH-7590	32	UG-3FW	48		
TH-92	32	TH-7590CP	23	UG-3W	48		
TH-500	32	TH-7590S	32	ULC-1	29		
TH-502	32	TH-7592	32	VCAP-.250	87		
TH-650	32	TH-CC-1	31	VCAP-.500	87		
TH-652	32	TH-CC-2	31	VCAP-1.375	35, 87		
TH-750	32	TH-CCL-1	31	VCAP-1.687	35, 87		
TH-750CP	23	TH-CCL-2	31	VCAP-2.125	35, 87		
TH-750XL	32	TH-DFR-1292	23	VHF-3	45		
TH-750XLCP	23	THSM-1	30	VHF-3WS	45		
TH-752	32	THSM-1XL	30	VHF-4	45		
TH-752XL	32	THSM-1KIT	30	VHF-4WS	45		
TH-7590S	32	THW-750	31	VTLP-8-1	6		
TH-1000	32	THW-1200	31	VTLP-8-2	6		
TH-1002	32	THW-1500	31	WAVE-15KIT-DP	98		
TH-1200	32	TMBMP-1	41	WAVE-27KIT-DP	98		
TH-1200CP	23	TMFR-1	41	WD-1	22		
TH-1200T	29	TMM-1-DP	41	WD-1CP-DP	22		
TH-1200XL	32	TSP-1	15	WDH-15B-"Y"	86		
TH-1200XLCP	23	TSP-2	15	WDH-15W-"Y"	86		
TH-1200XLT	29	TSP-1C	15	WDH-25B-"Y"	86		
TH-1202	32	TSP-1CP	15	WDH-25W-"Y"	86		
TH-1202XL	32	TSP-7	15	WDHH-25B-C-DP	86		
TH-1290	32	TT-52070	102	WDHH-25W-C-DP	86		
TH-1290CP	23	TT-52071	102	WDN-1	86		
TH-1290S	32	TT-52072	102	WDN-2	86		
TH-1290T	29	TT-52076	102	WDSB-"X"- "Y"	86		





# T-H Marine

T-H Marine Supplies, Inc. has been serving the marine industry

since 1975. We are a family owned and operated corporation that takes pride in every product that leaves our factory. We are boaters and fishermen who design products for boaters and fishermen. We are constantly striving to develop new and innovative products to offer our OEM and after-market customers and to bring these products to market faster than any other manufacturer. We have a long term commitment to providing quality products, excellent customer service, fast and accurate shipping, and competitive prices. We are always easy to do business with. T-H Marine thanks each of our customers for your continued business and ask others to give us a chance at being your supplier.



Bonnie Davidson  
Accounts Payable -  
Human Resource Manager



Beth Myers  
Accounts Receivable  
Assistant - Customer  
Service



Brandy Rainey  
Aftermarket Planner,  
Sales Assistant,  
AR Manager



Krystal Bendall  
Aftermarket Customer  
Service



Karen Harrison  
Aftermarket Customer  
Service



Stephanie Wellman  
OEM Customer Service



Bonnie Sendejo  
OEM Customer Service



Carol Thompson  
Receptionist



Melinda Haynes  
Administrative Assistant



Karen Garcia  
Graphic Designer



Proudly Serving the Marine Industry for Over 40 Years



# T-H MARINE SUPPLIES, INC.

Most Products Made  
With Pride In U.S.A.



200 Finney Drive  
Huntsville, Alabama 35824  
Telephone: 256.772.0164  
Fax: 256.772.7135  
[www.THMARINE.com](http://www.THMARINE.com)



*Proud Members of the following Marine Associations:*



NATIONAL  
MARINE MANUFACTURERS  
ASSOCIATION



NMDA  
NATIONAL MARINE DISTRIBUTORS ASSOCIATION  
YOUR LINK TO THE SUPPLY CHAIN



Setting Standards for Safer Boating®  
AMERICAN BOAT & YACHT COUNCIL



MRAA



AMERICAN  
SPORTFISHING ASSOCIATION