

Manual

For Operation



compact NX5

The ultra-compact simulator
and its system modules

compact NX5

Sys App 3.1.0.0 or higher

The compact NX5, whereby well understood NG says Next Generation, is the most versatile tester to cover transient and power fail requirements according to international standards (basic and generic standards) and product family standards. With the intuitive touch panel, the NX5 is the most economical solution for tests during development as well as for full-compliant immunity tests and CE Marking for single phase DUT with the ability to be extended for testing three-phase DUTs by means of an automatically controlled external coupling network up to 200A.

EM TEST supplies a large range of accessories for the various applications such as magnetic field tests and more.

EN/IEC 61000-4-4
EN/IEC 61000-4-5
EN/IEC 61000-4-8
EN/IEC 61000-4-9
EN/IEC 61000-4-11
EN/IEC 61000-4-12
EN/IEC 61000-4-29
EN 61000-6-1
EN 61000-6-2



Exclusion for Documentation

Unless specifically agreed to in writing, AMETEK Compliance Test Solutions (AMETEK CTS):

- (a) Makes no warranty as to the accuracy, sufficiency or suitability of any technical or other information provided in its manuals or other documentation.
- (b) Assumes no responsibility or liability for losses, damages, cost or expenses, whether special, direct, indirect, consequential or incidental, which might arise out of the use of such information. The use of any such information will be entirely at the user's risk, and
- (c) Reminds you that if this manual is in any language other than English, although steps have been taken to maintain the accuracy of the translation, the accuracy cannot be guaranteed. Approved AMETEK content is contained with English language version.

The present manual shows suggestions of test setups according to the standards IEC 61000-4-x using equipment manufactured by EM TEST.

The suggestions do certainly not replace the standards! Variations due to different interpretations of the standard are possible. The circuits shown in the figures supposed to illustrate the functional principles only and do not show every single detail of the components.

Manual information

Version / date:	1.06 / 10.01.2017
Replaces:	1.05 / 30.09.2016
Filename:	UserManual-compact-NX 5-E-V1.06.doc
Printdate:	10.01.17

Contact Information

EM Test (Switzerland) GmbH

Sternenhofstrasse 15
4153 Reinach BL1
Switzerland

Phone : +41 61 717 91 91

Fax : +41 61 717 91 99

URL : <http://www.emtest.com>

Copyright © 2017 EM Test (Switzerland) GmbH

All right reserved.
Information in earlier versions. Specifications subject to change

Contents

1. General	6
1.1. Purpose	7
1.2. Warranty Terms	7
1.3. Product return procedure	8
1.4. Recycling and Disposal	8
1.4.1. RoHS directive 2011/65/EU (RoHS 2)	8
1.4.2. WEEE directive 2012/19/EU	8
1.4.3. Dismantling information	8
1.4.4. Parts which can be recycled	8
1.4.5. Parts which cannot be recycled	8
2. Safety information	9
2.1. Intended use	9
2.2. Responsibility of the operator	9
2.3. General hazard	9
2.4. Qualification of personnel	10
2.5. Safety label on the device	10
2.6. Prohibition of unauthorized conversions and modifications	10
3. Installation put in service	11
3.1. Safety instructions for installation and initial installation	11
3.1.1. Qualifications of the staff	11
3.1.2. Installation	11
3.2. Installation of the compact NX5 system	12
3.2.1. Unpacking	12
3.2.2. Accessories	13
3.2.3. Options	13
3.2.4. Grounding and power connection	14
3.2.5. Mains Switch and fuse	15
3.2.6. Connecting the compact NX5 system to the ground reference	15
3.3. Safety circuit, Warning lamps	16
3.3.1. Safety circuit	17
3.3.2. Warning Lamp	17
3.4. EUT Power supply and power switch	18
3.4.1. Notes on protective devices which need to install the operator	18
3.5. System configuration	21
3.5.1. Power ON the compact NX5 generator	21
3.5.2. Help	23
3.5.3. Software Number for IEC.control software license	24
3.6. Software Update	25
3.6.1. Software Update new Version	25
3.6.2. Software Update Install SysOS	28
3.6.3. Export actual settings	30
3.6.4. Import the settings	32
3.6.5. Manual Firmware Update	34
4. Design and Functions	36
4.1. Front view	36
4.2. Rear view	38
4.3. Menu description	41
4.3.1. Main Menu	41
4.3.2. Menu Setting	42
4.3.3. Test phenomena	43
4.3.4. Test and Run Window	46
4.3.5. EUT Setup	49
4.3.6. Setup	53
4.3.7. TEST Link	60
4.3.8. Manager	60
4.3.9. Devices & Modules	60
4.3.10. Information	62
4.4. Service	63
4.5. Variable voltage transformers adjustment procedure	64

4.5.1.	Adjustment procedure for variable transformers	65
4.5.2.	Adjustment procedure for tapped transformers with analogue DC control voltage.....	67
5.	Test Equipment compact NX5 N	68
5.1.	compact NX5	68
6.	Technical data	69
6.1.	EFT Electrical Fast Transients Burst as per IEC 61000-4-4	69
6.2.	SURGE Immunity requirements as per IEC 61000-4-5	70
6.3.	Pulsed magnetic Field as per IEC 61000-4-9.....	71
6.4.	Power Fail Generator as per IEC 61000-4-11	72
6.5.	EUT Supply Specifications	73
6.6.	General Specifications.....	73
6.7.	Environmental conditions	73
7.	Maintenance setup and service	74
7.1.	General	74
7.2.	Maintenance and cleaning.....	74
7.3.	Test set- up.....	74
7.4.	Insulating- or external transformer for EUT power supply.....	74
7.5.	Calibration and verification	75
7.5.1.	Factory calibration	75
7.5.2.	Guideline to determine the calibration period of EM Test instrumentation	75
7.5.3.	Calibration of Accessories made by passive components only:	75
7.5.4.	Periodically In-house verification	75
8.	Delivery Groups.....	76
8.1.	Basic equipment	76
8.2.	Accessories and options.....	76
9.	EFT Burst as per IEC 61000-4-4	78
9.1.	Operation	78
9.1.1.	Quick Start.....	79
9.1.2.	Standard test routines	80
9.1.3.	Extended Test.....	81
9.1.4.	Max Burst impulses / s	82
9.2.	Burst Menu	83
9.2.1.	Configuration	84
9.3.	Burst generation	87
9.4.	Test level with Burst as per IEC 61000-4-4	87
9.5.	Coupling/decoupling network	88
9.5.1.	Coupling/decoupling network for ac/dc power lines	88
9.5.2.	Capacitive coupling clamp	88
9.6.	Burst Test Setup	89
9.6.1.	Test setup with capacitive coupling clamp	90
10.	Surge Immunity as per IEC 61000-4-5	91
10.1.	Operation	91
10.1.1.	Quick Start.....	92
10.1.2.	Standard test Routine.....	92
10.1.3.	User Test Routines.....	94
10.2.	Surge Menu	96
10.3.	Surge pulse settings	97
10.3.1.	Configuration	97
10.3.2.	Setup current peak limiter for surge current	100
10.3.3.	HV-COM output (18 μ F capacitor).....	101
10.4.	Surge pulse application	102
10.4.1.	Phase synchronization in 3-phase system	102
10.4.2.	Charging time for surge	102
10.5.	Surge pulse application	103
10.6.	Coupling/decoupling network	103
10.6.1.	Coupling to AC/DC power supply lines	103
10.6.2.	Coupling to I / O lines	104
10.7.	Test set-up.....	104

11. Magnetic field test as per IEC 61000-4-9	105
11.1. Pulsed Magnetic field as per IEC 61000-4-9	106
12. Voltage Dips and Interruptions as per IEC 61000-4-11	108
12.1. Test setup for DIPS and Interruption tests	108
12.2. Operation	110
12.2.1. Quick Start	111
12.2.2. Standard Test Routines	112
12.2.3. Extended Tests	113
12.3. Voltage Variation	114
12.4. Power Fail Menu	115
12.5. The Power Fail Test	116
12.5.1. Test routines termination	116
12.5.2. Operating	116
12.6. Overcurrent	117
12.7. The Power Fail Test	118
12.7.1. Voltage Interruptions	118
12.7.2. Voltage dips, voltage variations	119
12.8. DC Power networks	119
12.9. Test setup and accessories	120
12.9.1. Transformer type V4780	120
12.9.2. Variable Transformer variac NX1-260-16	122
13. Power frequency Magnetic Field as per IEC 61000-4-8	124
13.1. Magnetic field as per IEC 61000-4-8	125
14. Telecom Surge Immunity as per IEC 61000-4-5	128
14.1. Operation	128
14.1.1. Quick Start	129
14.1.2. Standard test Routine	129
14.1.3. Extended Test Routines	130
14.1.4. Generator Network for Telecom Surge	131
14.2. Telecom Surge Menu	132
14.3. Telecom Surge pulse settings	132
14.3.1. Configuration	132
15. Report	135
15.1. Block diagram for report generation	135
15.1.1. Save a report after the test	135
15.2. Report setting	136
15.3. Report Export	137
16. Appendix	138
16.1. Declaration of CE-Conformity	138
16.1.1. CE-Conformity compact NX5	138
16.1.2. CE-Conformity V4780	139
16.1.3. CE-Conformity V4780	140
16.2. compact NX5 General Diagram	141
16.3. Main diagram control connection	141
16.4. Main diagram high voltage connection	143

1. General

The following manual is based on the following or later firmware:

Available Generators Compact NX Family	Burst	Surge	Power Fail	Telecom Surge
16 A models				
compact NX5 bsp-1-300-16	X	X	X	
compact NX5 bst-1-300-16	X	X		X
compact NX5 bspt-1-300-16	X	X	X	X
compact NX5 bs-1-300-16	X	X		
compact NX5 bp-1-300-16	X		X	
compact NX5 sp-1-300-16		X	X	
compact NX5 st-1-300-16		X		X
compact NX5 b-1-300-16	X			
compact NX5 s-1-300-16		X		
32 A models				
compact NX5 bspt-1-300-32	X	X	X	X
compact NX5 bsp-1-300-32	X	X	X	
compact NX5 bst-1-300-32	X	X		X
compact NX5 bs-1-300-32	X	X		
compact NX5 bp-1-300-32	X		X	
compact NX5 sp-1-300-32		X	X	
compact NX5 st-1-300-32		X		X
compact NX5 b-1-300-32	X			
compact NX5 s-1-300-32		X		
compact NX5 p-1-300-32			X	

1.1. Purpose

The compact NX5 test system is a multifunction compact generator that simulates conducted electromagnetic interference effects for immunity testing according to international, national, and manufacturers' standards.

The system is designed for full compliance conducted electromagnetic compatibility (EMC) test requirements. The application range is for testing of industrial, light industrial, household or commercial equipment, including many product family and product standards as per following basic standards

- IEC 61000-4-4 EFT / Burst
- IEC 61000-4-5 Surge
- IEC 61000-4-8 50/60Hz Magnetic Field
- IEC 61000-4-9 Pulse Magnetic Field
- IEC 61000-4-11 Voltage Dips, Voltage Interruptions for ac power mains supply
- IEC 61000-4-29 Voltage Interruptions
Voltage Dips for dc power supply systems

1.2. Warranty Terms

EM TEST provides this written warranty covering the product stated above, and if the buyer discovers and notifies EM TEST in writing of any defect in material or workmanship within the applicable warranty period stated above, then EM TEST may, at its option: repair or replace the product; or issue a credit note for the defective product; or provide the buyer with replacement parts for the product.

The buyer will, at its expense, return the defective product or parts thereof to EM TEST in accordance with the return procedure specified below. EM TEST will, at its expense, deliver the repaired or replaced product or parts to the buyer. Any warranty of EM TEST will not apply if the buyer is in default under the purchase order agreement or where the product or any part thereof:

- is damaged by misuse, accident, negligence or failure to maintain the same as specified or required by EM TEST;
- is damaged by modifications, alterations or attachments thereto which are not authorized by EM TEST;
- is installed or operated contrary to the instructions of EM TEST;
- is opened, modified or disassembled in any way without EM TEST's consent; or
- is used in combination with items, articles or materials not authorized by EM TEST.

The Buyer may not assert any claim that the products are not in conformity with any warranty until the buyer has made all payments to EM TEST provided for in the purchase order agreement.

1.3. Product return procedure

1. Request a Return Material Authorization (RMA) number from the local EM TEST representative
2. When requesting an RMA, have the following information ready:
 - Model number
 - Serial number
 - Description of the problem

NOTE: Unauthorized returns will not be accepted and will be returned at the shipper's expense.

NOTE: A returned product found upon inspection by EM TEST, to be in specification is subject to an evaluation fee and applicable freight charges.

1.4. Recycling and Disposal

1.4.1. RoHS directive 2011/65/EU (RoHS 2)

RoHS directive *2011/65/EU* (RoHS 2)

The EM TEST compact NX5 series generator complies with the directive 2011/65/EU (RoHS - Restriction of certain Hazardous Substances).

From December 2005, all EM TEST products either hand soldered or by machine are produced using lead-free solder.

1.4.2. WEEE directive 2012/19/EU

The EM TEST compact NX5 serie generator, is dedicated under category 9 in the directive 2012/19/EU (WEEE).

The product should be recycled through a professional organization with appropriate experience for the disposal and recycling of electronic products. EM TEST is also available to help with questions relating to the recycling of this equipment.

1.4.3. Dismantling information

Always remove power cord first. There is no special danger involved in dismantling the compact NX5

1.4.4. Parts which can be recycled

The NX5 generator contains parts made from steel, aluminum, PVC, two-component sealing compound. The impulse capacitors are filled with non-poisonous mineral oil. The various parts can be separated and recycled.

1.4.5. Parts which cannot be recycled

All parts in the compact NX5 series can be recycled.

2. Safety information



Attention

Before using this equipment, read the operating manual and the separate delivered **safety manual** carefully

2.1. Intended use

The “compact NX5” test system is designed primarily for conducted transient interference tests as specified in the European generic standards IEC/EN 61000-6-1 to cover equipment for household, office and light industrial use, and IEC/EN 61000-6-2 for applications in industrial environments. The “compact NX5” generates these tests in accordance with IEC/EN 61000-4-4, -4-5, -4-11, -4-18 and -4-29, depending of the model configuration. Accessories are available for generating optional tests to IEC/EN 61000-4-8 and -9.

The EMC Directive 2014/30/EU (for the assignment of the CE mark) refers to these standards and to this type of equipment.

2.2. Responsibility of the operator

These operating instructions form an essential part of the equipment and must be available to the operator at all times. The user must obey all safety instructions and warnings.



WARNING

The purpose of this instrument is the generation of defined interferences signals for EMI immunity testing. Depending on the arrangement of the test rig, the configuration, the cabling and the properties of the EUT itself, a significant amount of electromagnetic radiation may result that could also affect other equipment and systems.

The equipment is designed to operate in industrial environment. For operating in other or sensitive environment, such as light industry, airport area..., the user may use a shielded room for operate.

The user himself or herself is ultimately responsible for the correct and controlled operation of the rig. In case of doubt, the tests should be carried out in a Faraday cage.

2.3. General hazard

Before applying power to the system, verify that your product is configured properly for your particular application.



WARNING

The Compact NX5 system and its accessories operate at high voltages.

Hazardous voltages may be present when covers are removed. Qualified personnel must use extreme caution when servicing this equipment.

Circuit boards, test points, and output voltages also may be floating above (below) chassis ground.

Only *qualified personnel* who deal with attendant hazards in impulse generators, are allowed to perform installation and servicing.

Ensure that the AC power line ground is connected properly to the Power Rack input connector or chassis. Similarly, other power ground lines including those to application and maintenance equipment *must* be grounded properly for both personnel and equipment safety.

Always ensure that facility AC input power is de-energized prior to connecting or disconnecting any cable.

The user must ensure that the output power lines are labeled properly as to the safety hazards and that any inadvertent contact with hazardous voltages is eliminated.

Guard against risks of electrical shock during open cover checks by not touching any portion of the electrical circuits. Even when power is off, capacitors may retain an electrical charge. Use safety glasses during open cover checks to avoid personal injury by any sudden component failure.

Neither AMETEK CTS, or EM TEST (Switzerland) GmbH, nor any of the subsidiary sales organizations can accept any responsibility for personnel, material or inconsequential injury, loss or damage that results from improper use of the equipment and accessories.

**WARNING**

Personnel fitted with a heart pacemaker must neither operate the instrument nor approach the test setup while a test is being executed.

Only approved accessories, connectors, adapters, etc. are to be used to ensure safe operation.

2.4. Qualification of personnel

The compact NX5 must be operated only by authorized and trained specialists.

2.5. Safety label on the device

Please take note of the following explanations of the symbols used in order to achieve the optimum benefit from this manual and to ensure safety during operation of the equipment.



This symbol warns of a potential risk of shock hazard. The symbol on an instrument shows that that it can source 1000 volt or more, including the combined effect of normal and common mode voltages. Use standard safety precautions to avoid personal contact with these voltages.



This symbol indicates where a caution is required. Refer to the operating instructions located in the manual in order to protect against personal injury or damage the equipment.

CAUTION

The CAUTION symbol indicates a potential hazard. It calls attention to a procedure, practice or condition which, if not followed, , could possibly cause damage to equipment. Such damage may invalidate the warranty. If a CAUTION is indicated, do not proceed until its conditions are fully understood and met.

WARNING

The WARNING symbol indicates a potential hazard. It calls attention to a procedure, practice or condition which, if not followed, could possibly cause bodily injured or death. If a WARNING is indicated, do not proceed until its conditions are fully understood and met.

2.6. Prohibition of unauthorized conversions and modifications

The user is not entitled to the device to perform its own modifications and adaptations. Modifying parts on the generator by unauthorized persons will void the warranty of the device and the correct functioning cannot be guaranteed.

3. Installation put in service

This chapter includes a checklist with steps that should be taken before the compact NX5 generator is switched on and put into operation.

3.1. Safety instructions for installation and initial installation

National regulations in installation and operation of electrical equipment must be respected.



WARNING The compact NX5 test system is not suitable for use in an explosive atmosphere.



WARNING Connect the EUT only after the initial system setup has finished.

3.1.1. Qualifications of the staff

Basic knowledge of electrical engineering and electromagnetic compatibility is required to service the unit. The national regulations for installation of electrical equipment as well as the safety at work of electrical equipment must be known to the user.

3.1.2. Installation

The Compact NX5 system conforms to protection class 1. Local installation regulations must be respected to ensure the safe flow of leakage currents.



WARNING Operation without a ground connection is forbidden!

Two independent ground connections are necessary - one for the test system and one for the EUT. These must be connected back to the local permanent installation or to a fixed, permanent ground conductor.

Operate the equipment only in dry surroundings. Any condensation that occurs must be allowed to evaporate before putting the equipment into operation. Do not exceed the permissible ambient temperature or humidity levels. Use only officially approved connectors and accessory items.

Ensure that a reliable return path for the interference current is provided between the EUT and the generator. The ground reference plane and the ground connections to the instruments, as described in the relevant test standards, serve this purpose well.

The test system may only be opened by a qualified specialist upon specific instruction given by the manufacturer. The equipment works, on principle, with two independent power supplies, one for the generator and one for the EUT. The compact NX5 must be disconnected from both sources before any modifications to the test setup are undertaken. Besides the mains connections themselves, certain components also operate at high voltages, and are not provided with any form of extra protection against accidental contact.

The system complies with the safety requirements of IEC/EN 61010-1 (Safety requirements for electrical equipment for measurement, control and laboratory use).

It is the user's responsibility to ensure that the test rig does not emit excessive electromagnetic interference (EMI) that might affect other equipment. The test system itself does not produce any excessive radiation; however, the injection of interference pulses into the EUT can result in the device and/or its associated cables radiating EMI. To avoid radiating unwanted interference the standards organizations recommend that the test setup be located in a Faraday cage.

Since the purpose of the test system is to produce interference signals for interference immunity testing, the requirements in the IEC/EN 61000 series concerning limiting the radiated EMI can only be complied with by operating the test system inside a Faraday cage.

3.2. Installation of the compact NX5 system

3.2.1. Unpacking

Check the packaging for signs of damage in transit. Any damage should be reported immediately to the transportation company and the local representative.

Lift the compact NX5 test system out of its packaging. Place the test system so that there is sufficient free space around the cooling air inlets on both sides and behind the fan outlet on the rear panel.





NOTE Do not dispose of packaging materials. All packaging should be retained in the event that the instrument or any of its accessories should need to be returned to a EM TEST service center for repair or calibration.

Using the following list, check that all the items ordered have been delivered:



Item	Name	Remark	Picture
1	Compact NX5	Compact NX5 generator including - Single phase coupling network 300 V / 16 A Including ordered Modules - Burst Module - Surge Module - Power Fail Module - Telecom Surge Module	
2	Power Mains cable	Power Mains cable - Connectors country coded	
3	ESC	EUT Supply Cable - Connectors country coded	
4	ESA1	EUT Supply Adapter - Connectors country coded	
5	SCC AD	Safety Circuit Adapter (Sys. Link) Short circuit for Interlock	
6	SWL AD	Warning Lamp Adapter	
7	Ethernet cable	Ethernet crossover network cable RJ45, Cat 6, SF/UTP, red	
8	Cleaning tissue		
9	Safety Manual	Safety Manual 200 / 500 /NX Series	
10	Quick Start Guide	Quick Start Guide Compact NX – English or German	
11	USB Memory card	Files on USB Memory card	
12	User Manual	User manual (pdf on the memory card)	
13	iec.control Software	Software iec.control, (on the memory card)	
14	Software license	If ordered on a license sheet - UOC Optolink Converter USB to LWL - Optical fiber cable 5m	

3.2.2. Accessories

If additional equipment is ordered refer to the user manual of these devices

Name	Remark	Picture
SLC xxx	Sys Link Cable with various cable length	
UOC	USB Optolink Converter (USB to LWL) Optical Fiber cable, 5m Remark: The USB Optolink is included in the software license	
Copper braid	Earh band connection NX-generator to coupling NX, Dimension: 300 x 23 mm, 25mm ² , 4 x Screws M4 x 10mm	

3.2.3. Options

Name	Remark	Picture
PVF BKIT 1	Pulse Verification Fast Burst Kit 1 PVF 50, Pulse Verification Fast 50 Ohm PVF 1000, Pulse Verification Fast 1000 Ohm PVF AD 1 Pulse Verification Fast Adapter 1 – Multi Contact (MC) to SHV fix	 PVF AD1 PVF 50 or PVF 1000
ICC PVKIT 1	Industrial Capacitive Coupling Clamp Pulse Verification Kit 1 Transducer plate Support PVF AD3 Pulse Verification Fast Adapter 3 – MC to SHF	 Transducer Plate PVF AD3 PVF 50 Support
ESS 1	ESS 1 Interlock for NX5 system Switches OFF High voltage and EUT power supply	

3.2.4. Grounding and power connection

Two independent ground connections are necessary- one for the test system and one for the EUT. These must be connected back to the local permanent installation or to a fixed, permanent ground conductor. To avoid electric shock the power cord protective grounding conductor must be connected to ground.

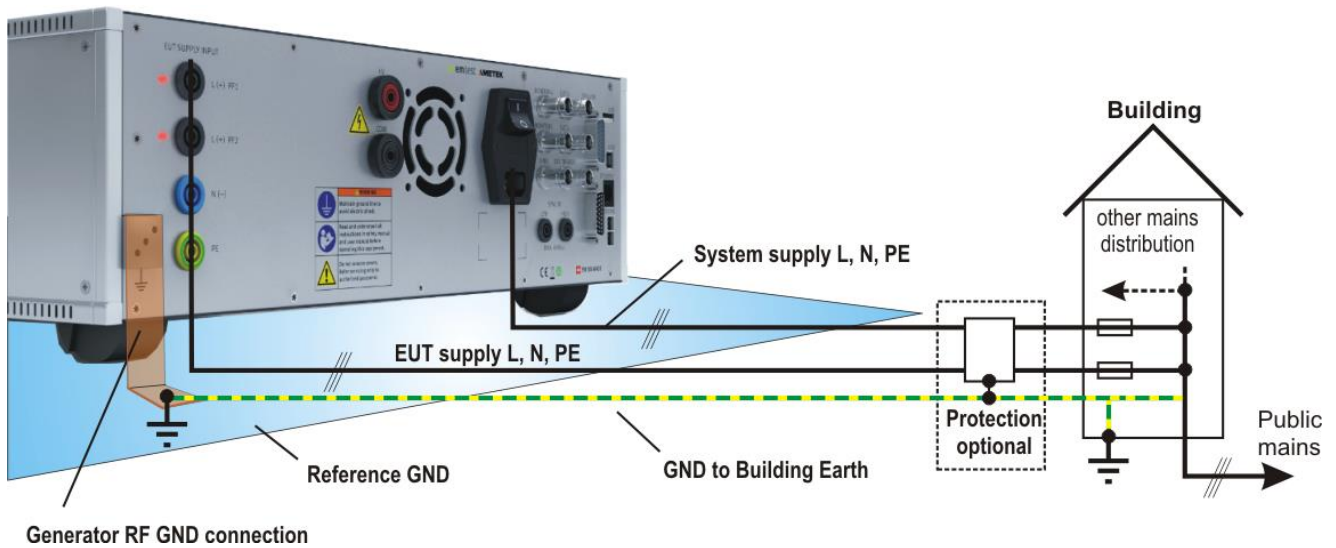

System GND

The system is connected to GND via the earth wire of the connected mains power cable for the generator and the EUT supply. A separate GND wire from the reference GND plane to the building earth point may be useful to avoid interferences to other areas.

EUT GND

Ensure that a reliable return path for the interference current is provided between the EUT and the generator. The GND wire from the generator to the reference GND and must be designed as a low inductance connection suitable for high frequencies. The reference ground plane and the ground connections to the instruments, as described in the relevant test standards, serve this purpose well.

Protection (optional)

A proposal is to separate protection of the EMC system with filters, insulation transformer or fault current protection and other measures may be useful for the EMC installation. The advantage is the separation of the EMC system from all other installation.

A shielded room with adequate filters may be the best solution for avoid unwanted conducted and radiated interference to other areas.

3.2.5. Mains Switch and fuse

The mains power voltage indicated on the instrument must correspond with the local supply voltage (mains voltage: 85–265 Vac, universal power unit, mains frequency: 50–60 Hz).

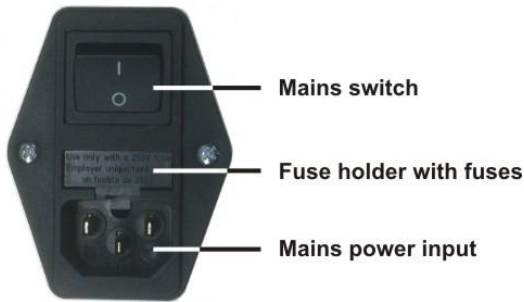

Mains Switch, fuse holder and power input

To replace a fuse:

- 1) Disconnect the mains cable
- 2) Pull the fuse holder out of the connector
- 3) Remove the damaged fuse(s)
- 4) Insert 1 or 2 fuses (4 A / 115V and 2 A / 230 V slow blow)
- 5) Replace the fuse holder
- 6) Plug the mains cable into a power outlet with a solid ground connection
- 7) Switch the system on and operate as instructed in this manual

3.2.6. Connecting the compact NX5 system to the ground reference

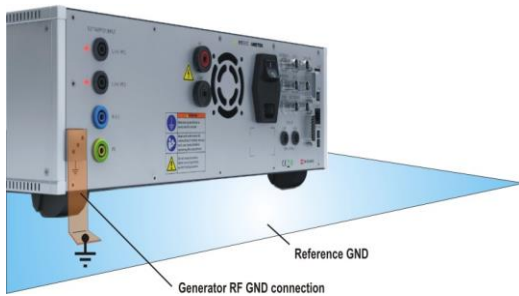

Connection to reference ground

Connection to reference ground

For burst tests, the generator must be placed on a ground reference plane which is connected to ground.

A low inductive high frequency ground connection between the test system and the ground reference plane (GRP) is absolutely essential for performing burst tests correctly.

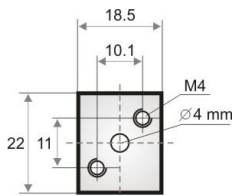

Earth Bolt 18.5 x 22 mm

Earth bolt dimension

Earth bolt dimensions:

Screws: Metric M4 ,
Distance: 10.1 mm x 11 mm
Plug: Banana plug, \varnothing 4 mm

3.3. Safety circuit, Warning lamps

Safety circuit and warning lamps are located at each end of the Sys Link. Each End of the Sys.Link is terminated with an adapter.

Safety circuit

Plug position: **SYS.LINK IN** Compact NX generator
 Connector: 2 screw contacts IN, OUT
 Pin Sys Link: 7, 16
 Operating: short circuit closed = operation
 short circuit open = no operation
 Voltage level: 24 Vdc (internal powered)

Warning Lamp

Plug position: **SYS.LINK OUT** Last device from daisy chain
 Connector: 2 screw contacts IN, OUT
 Pin Sys Link: 8, 17
 Operating: Potential free contact
 open = System is out of operation (green)
 closed = System is operating (red)
 Voltage level: 60 V, max. 2 A (external powered)

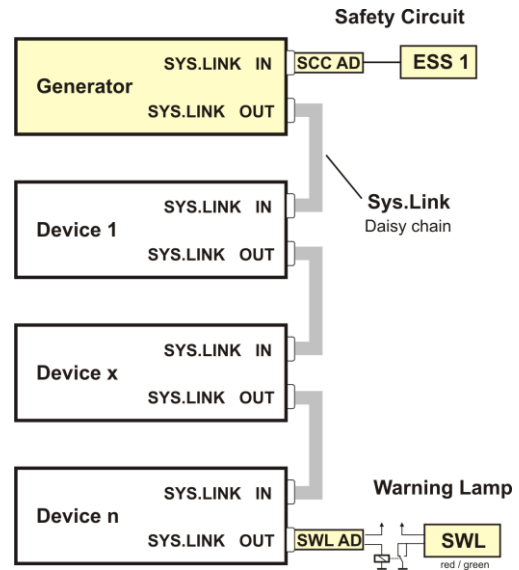

Important for operation

Connect the delivered Safety Circuit adapter **SCC AD** to the **SYSLINK** plug.

The compact NX generator does not start any test if the safety circuit is not connected and closed.

NOTE: *The short circuit is already short-circuited at the delivered Safety circuit adapter SCC AD.*



IMPORTANT



3.3.1. Safety circuit

The safety circuit locks the system and enables the generation of the high voltage impulses in the generators.

Design

Each device that has internal relevant high voltage unit, includes a safety circuit. The safety circuit works like an “open collector circuit”, where the external safety loop must be closed for switch on the high voltage.

Safety circuit closed

The device will generate high voltage pulses after start

Safety circuit open

The device will switch off the high voltage and discharges the high voltage circuit

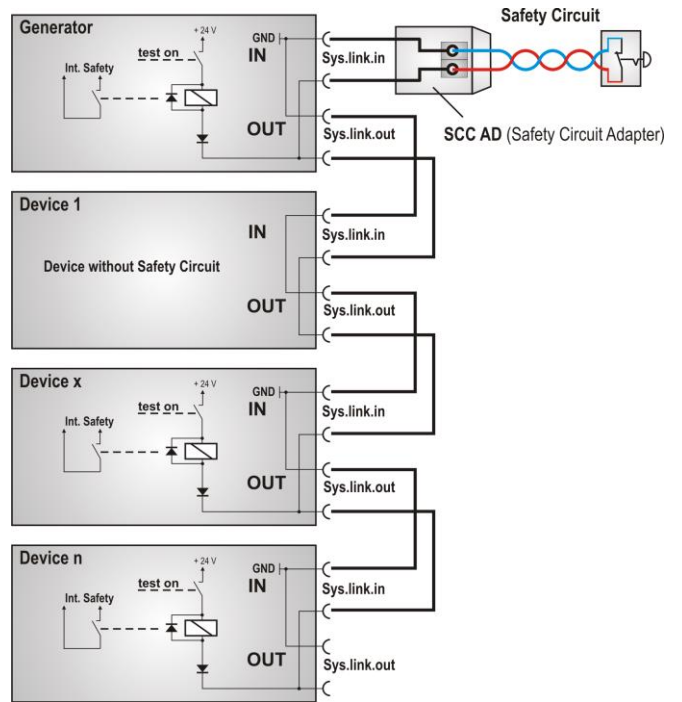

3.3.2. Warning Lamp

The warning lamp offers a voltage free contact that indicates the status of the generator system.

Design

Each device with warning lamp function can short the warning lamp contact. An external powered relays max. 60 V / 2 A controls the lamp. The user is responsible for the warning lamp power supply

Warning Lamp switch closed (red):

- Safety circuit is closed and
- TEST ON is on

Status: RED Lamp, Power on EUT output,
High voltage can be “switched ON”

Warning Lamp switch opened (green):

- Safety circuit is open and / or
- TEST ON is off
- Generator is switched off

Status: GREEN Lamp, no danger, High voltage is off

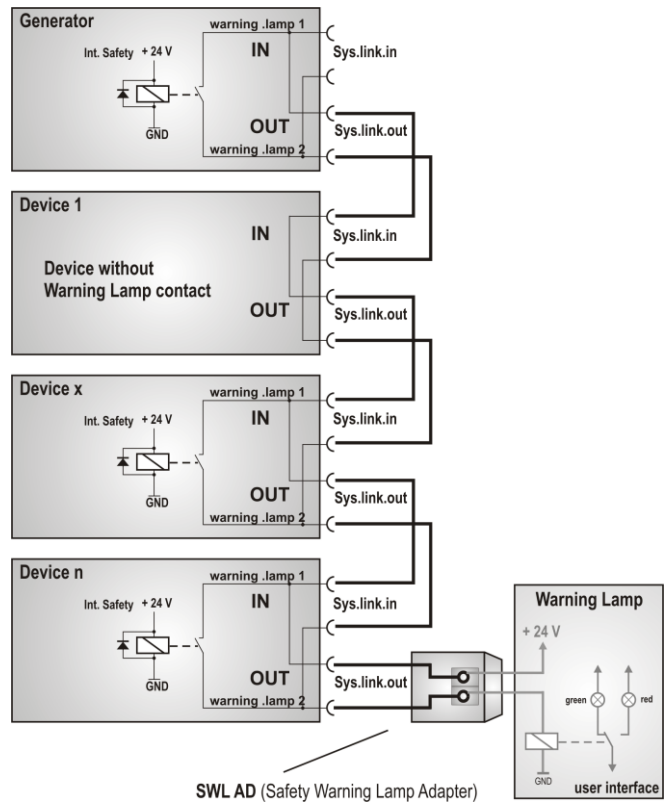

3.4. EUT Power supply and power switch

The EUT input should be connected through a properly rated power switch device, which should be located close to the test setup. In order to ensure easy and quick access to the EUT power, the switch should be clearly and visibly labeled as “EUT power ON/OFF”.

The in-house power distribution must be equipped with a proper circuit breaker and an emergency off button as per IEC 61010-1:2001.

Dimensioning of the mains supply and rating of fuse protection of the AC or DC power supply must conform with local electrical codes and EUT requirements. Inappropriate arrangement, mounting, cabling or handling of the EUT or ground can reduce or negate the effectiveness of the compact NX5's safety features.

3.4.1. Notes on protective devices which need to install the operator

There are two different protective devices in a mains distribution system for safe operation.

- A Fault current protection:** A **residual-current device** (RCD), or residual-current circuit breaker (RCCB) is an electrical wiring device that disconnects a circuit whenever it detects that the electric current is not balanced between line and the return neutral. In normal circumstances, these two wires are balanced, and any difference current usually indicates a short circuit or other electrical anomaly like a surge impulse is present.
- B Circuit breaker protection:** A **circuit breaker** is an electrical switch designed to protect an electrical circuit by overload or short circuit. Its basic function is to detect a fault condition and interrupt current flow.

3.4.1.1. Fault current protection

The standards recommend decoupling and filter capacitors to PE for decoupling surge pulses. This is the reason for tripping fault current protection relays that interrupt the mains to the EUT supply. For eliminate the circumstance use one of the following options:

Remove the fault current protection

This solution does not limit the current to PE. The surge test as other EMC tests with higher currents to PE are possible. The user must take care to the circuit with no fault current protection. Only trained professional people are allowed to perform such tests. Some countries do not allow to operate without fault current protection.

Using of insulating transformers

An insulating transformer separates the circuit from the test circuit. The Fault current detector (FI protection) cannot detect the earth current in the EUT circuit.



The fault current safety detection function in the generator circuit is disabled. The user must respect this circumstance. For a safe operation he must follow the electrical rulers.

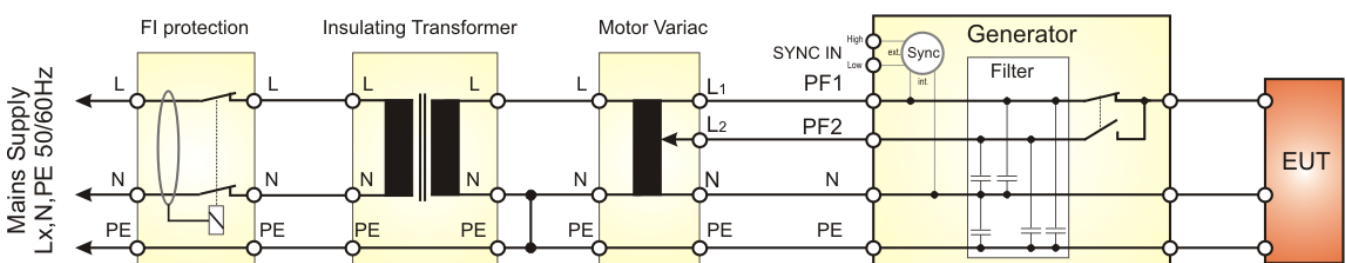

Behind the insulating transformer the neutral and PE must be connected for a proper phase synchronization of the generator. In case of a 3-phase system the user must perform similar.

3.4.1.2. Fuses for EUT with smaller nominal currents

The EM Test pulse generators have no built in fuse for the EUT power supply. It is in the scope of responsibility of the user to protect the EUT external for the rated current.



The design of the external fuse must be match the following rules:

- fuse dimension must be **equal or smaller** than the **rated EUT current** of the connected **test generator**
- fuse must be designed for **protect the connected EUT** device under test in malfunction

Example of external circuit breaker

Circuit breakers in the building are designed for 32 A. A circuit breaker box with 16 A protection is installed between the building supply and the test generator.

Test generator and EUT are now fused for 16 A rated current

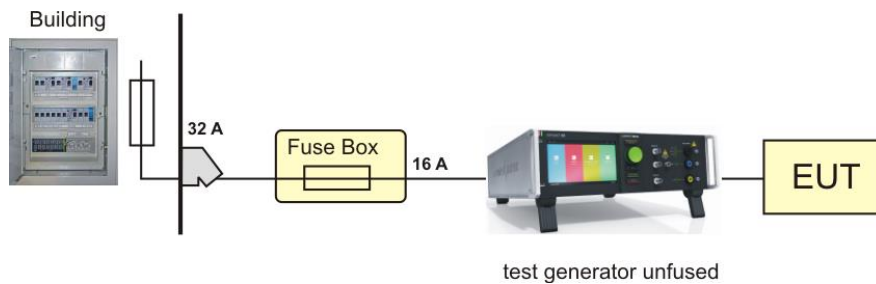

3.4.1.3. Phase indicator

The phase indication shows the correct connection of the supply to **Phase** and **Neutral** input of the compact NX5. For the generator hardware both, L and N paths are potential free and a reverse connection is not relevant for the generator operation.

For EUT where it is important that phase and neutral are correct, the LED indication shows the correct phase connection.

Phase indication

- 1 compact NX5 generator
- 2 EUT supply may be a
 - **direct supply from building** or via a
 - **tapped or variac transformer**
- 3 Phase indication LED illuminated
- 4 Phase indication LED inactive

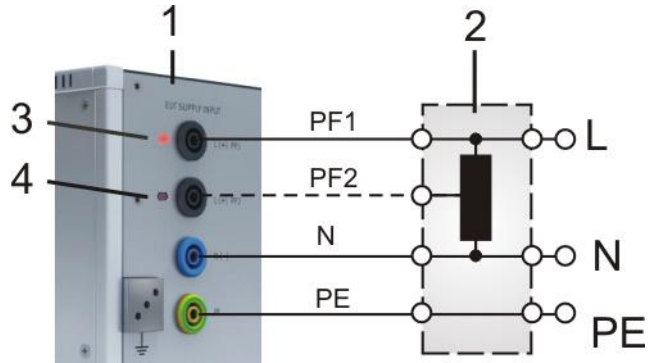

Remark: The phase synchronization signal taken from the L path.

The table below shows all combinations with correct (OK) and incorrect (Fail) supply connections

Type A

Supply to PF1, L, PE



Type B

Supply to PF1, PF2, L, PE



Type C

Supply to PF2, L, PE



3.5. System configuration

This chapter describes how to configure the compact NX5 generator to work with the EUT and the connected accessories. The software library includes all accessories with their parameters. Some parameters must be matched to the current device. For device, that is not existing in the library, the user has to create one by modify an existing equipment.

Procedure

The following system configuration is a short instruction guide. For detail setting refer to the related chapters in this manual.

1. Power ON the compact NX5 generator
2. EUT configuration setup
3. System settings
4. Transformers settings
5. External coupler settings

NOTE: If you have ordered the complete NX5 System from EM TEST, the System configuration was completed in the EM TEST factory in Switzerland

3.5.1. Power ON the compact NX5 generator

Approx. 3-4 seconds after power on the generator will drive the ventilator at full speed during few seconds. Then the ventilator returns to a variable speed control concerning the temperature.

Booting

After the welcome screen the software scans the equipment for search all existing internal phenomenon's and external devices.

A list shows and list all detected modules.

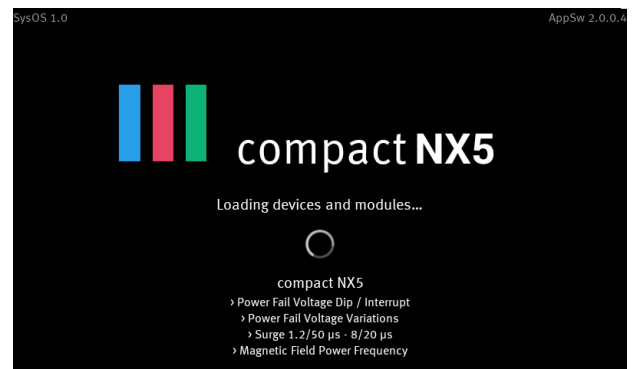

Home screen after booting

The home screen shows all detected symbols of phenomenon with their color.

Next steps:

1. EUT configuration setup
2. Menu / Setup for
 - System settings
 - Transformer settings
 - External coupler settings

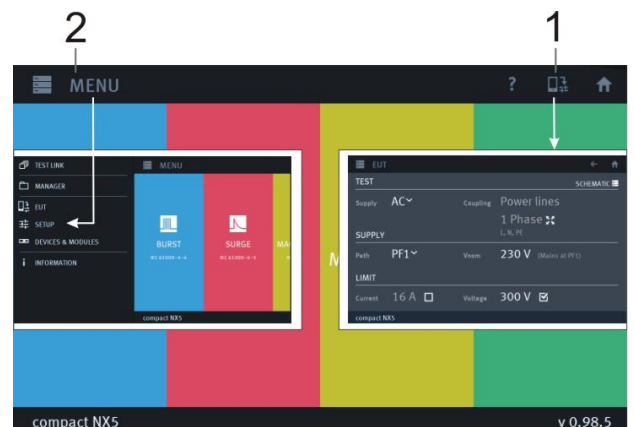

EUT configuration Setup

Supply: **AC**

Coupling: 1 phase set  to **L, N, PE**

Path: **PF1**

Vnom: **230 V** (115 V)

Limit: all disabled

NOTE: For detailed information see chapter 4.3.5. EUT Setup

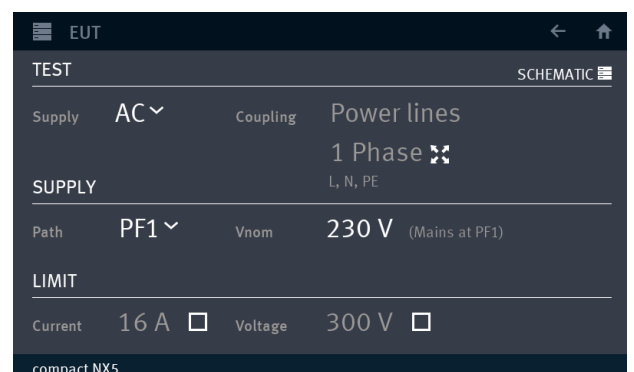

System settings

Setup General

System: **Language** if other than English

Date / Time: modify

Setup Equipment

- Transformers
- External couplers

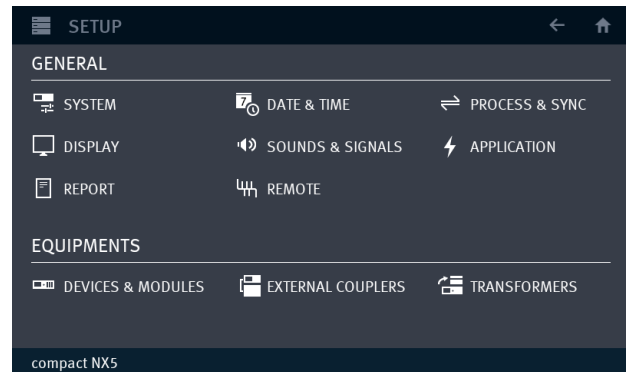

Transformers

If you have no variac or tapped transformer, you can skip this paragraph.

Add a Transformer into the setup

1. Select **ADD** for open the add transformer window
2. Select **VARIABLE** or TAPPED
3. Select the transformer (variac NX1-260-16)
4. Press **ADD** for close and exit

NOTE: See separate chapter for adjust the variable transformer parameters.

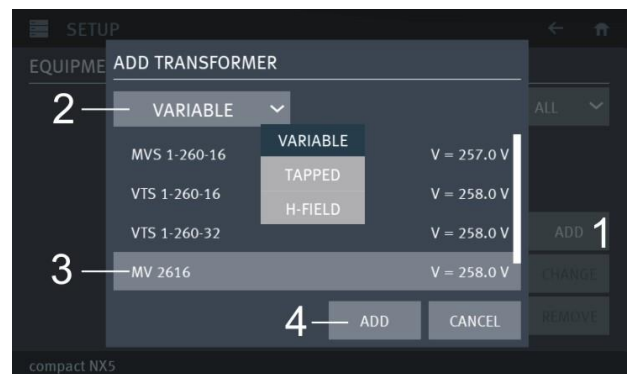

External couplers

External 3-phase coupling NX series devices are detected after power up the system automatically. If you have no magnetic field coil or external 3-phase coupling network, you can skip this paragraph.

Add an external coupler into the setup

1. Select **ADD** for open the add ext. couplers window
2. Select **CDN** or COIL
3. Select the transformer (variac NX1-260-16)
4. Press **ADD** for close and exit
5. Select **⬆** for return to the Home screen

NOTE: See separate chapter for adjust the external coupler parameters.

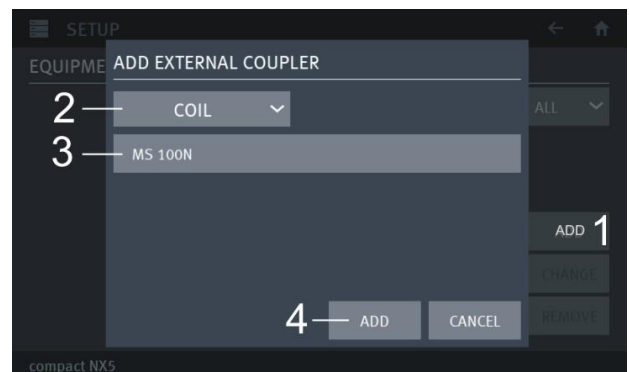

For operate a test see chapter **4.3.3. Test phenomena** and **4.3.3.1. Parameter setting**

3.5.2. Help

A short start guide instruction delivers a short instruction for Compact NX5 operation. The example guides the user for proceed a Burst test.

	<p>Start screen for Help after touch the  Help symbol on the Home screen</p>		
<p>General Safety Instructions</p>	<p>Front Connections</p>	<p>Rear Connections</p>	<p>Control Elements</p>
<p>Home Screen</p>	<p>Quick Start</p>	<p>Pulse Settings, wheel</p>	<p>Pulse Settings, numeric pad</p>
<p>Pulse Settings, information</p>	<p>Test Run</p>		

3.5.3. Software Number for IEC.control software license

Software Update procedure

1. Select **MENU / Setup**

2. Select **DEVICES & MODULES**

3. Make a **click** or **long click** to compact NX5 or press **change**

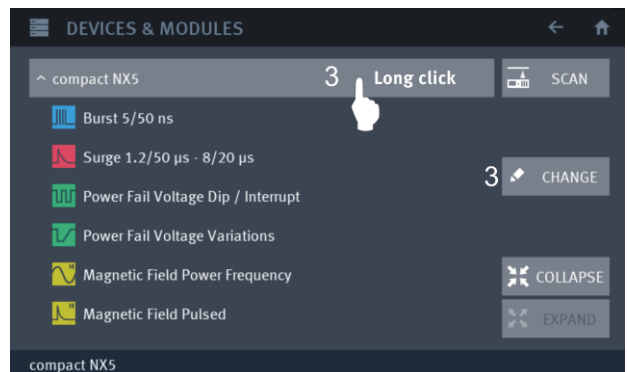
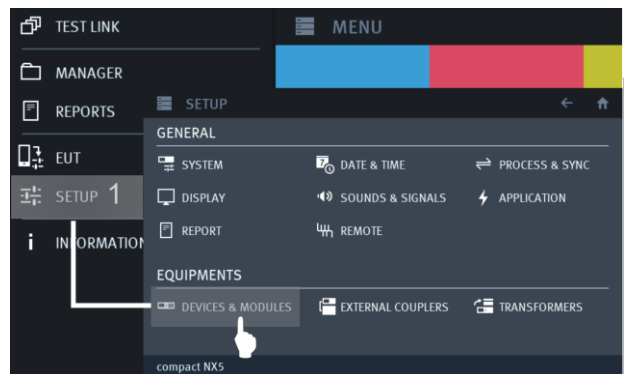

The yellow field indicates the information for:

- **Serial number**
- **Software number**
This number is matched with the **license** code in the **IEC.control** software

Active	Device	License	Serial No.	Interface	Coupling Network	Software No.	Firmware
<input checked="" type="checkbox"/>	compact NX5	A0AP989VP9	P1524158999	TCP/IP::10.0.0.10	coupling NX5	000025	2.0.2.0
<input type="checkbox"/>	None				No Cbk		

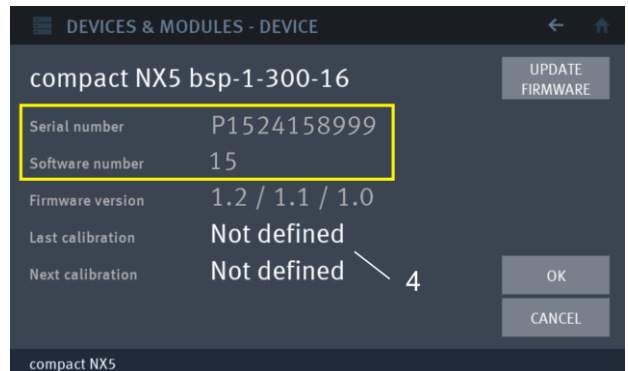

4. Click **Not defined** for enter a date for:

- Last calibration date
- Next calibration date

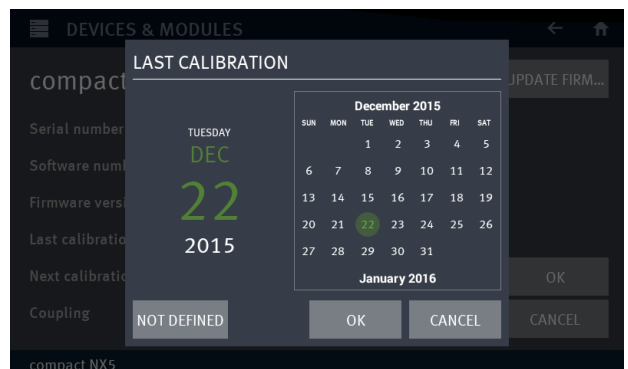

3.6. Software Update

For update the NX generator with a new software it is necessary to copy the new software to an empty USB memory stick.

The following software updates, backup and restore procedures are described in this chapter.

A 3.6.1 Software update new version

B 3.6.2 SysOS update

This update overwrites the settings to the factory setting. A previous **Backup with Export Settings** is strongly recommended

C 3.6.3 Export actual settings

D 3.6.4 Import settings

F 3.6.5 Firmware update

3.6.1. Software Update new Version

Software Update procedure

1. Select **MENU / INFORMATION**

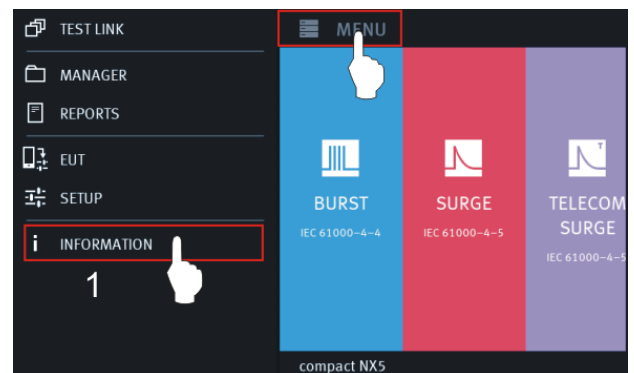

Software Update procedure

2. Press **Update Software**

Note: The button Update SysOS is only displayed when a new SysOS is recognized.



A message appears to **insert an USB memory stick** with a valid update package to the front or back side USB Port.

The update file will be automatically detected

SW filename: **com.cts.appsw.apk**

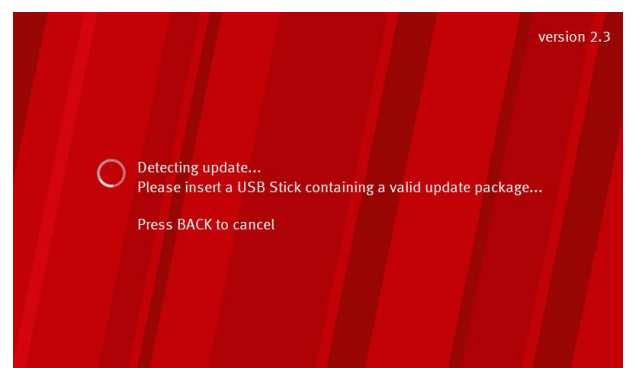

3. Press **INSTALL** for start the update procedure. The update process is shown on the screen.

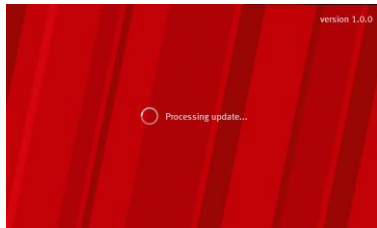

updating

Press **CANCEL** for exit



4. After display Update successfully done, **remove** the USB Sticks when indicated

A counter will indicate that the device will reboot after 10 seconds

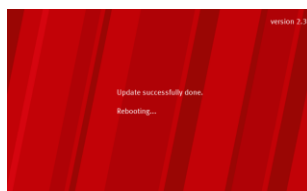

System reboot

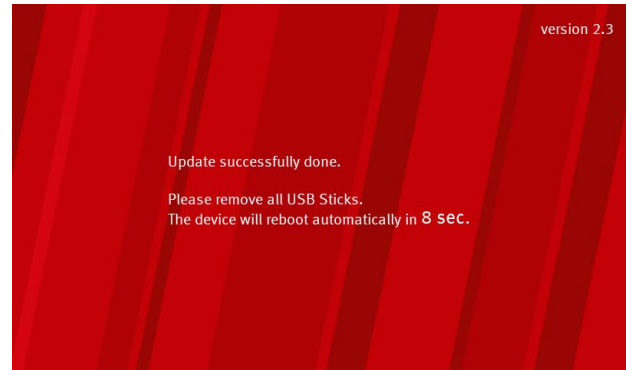

6. If you get the following message after rebooting,
- Click **OK**,
 - Continue** with **step 7 to 12** for the Phenomenon Firmware update to complete.
 - Then continue** with the following steps:
 - Save the settings on an USB Stick
 - Proceed the SysOP upgrade
 - Import the saved settings from the USB stick

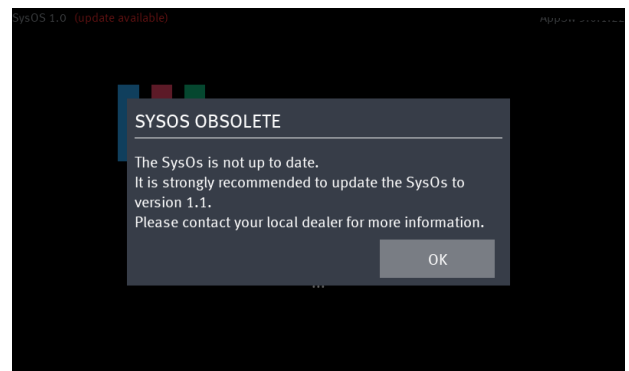

7. After switch on,
DO not switch OFF while updating
After the update the system is loading the devices

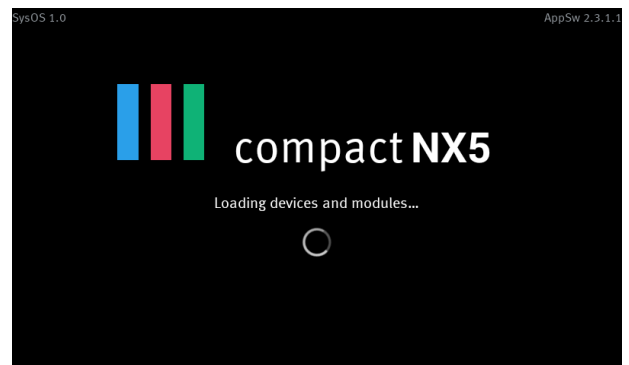
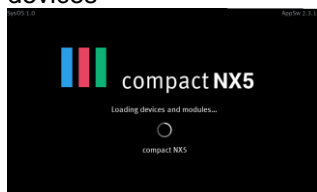

8. After switch on,

DO not switch OFF while updating

After the update the system is loading the devices

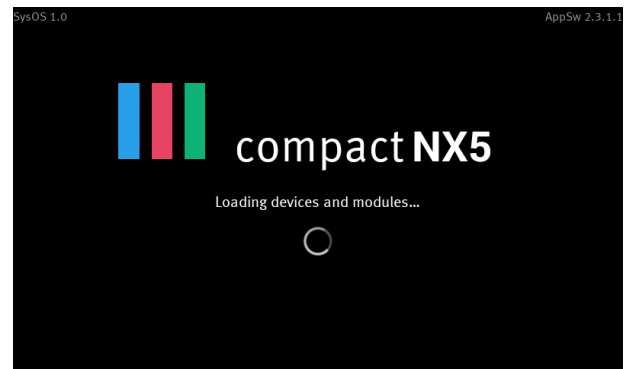

9. When starting a new app-sw version, the system checks the actual firmware versions and indicates the

Actual firmware versions and

Available updates for install

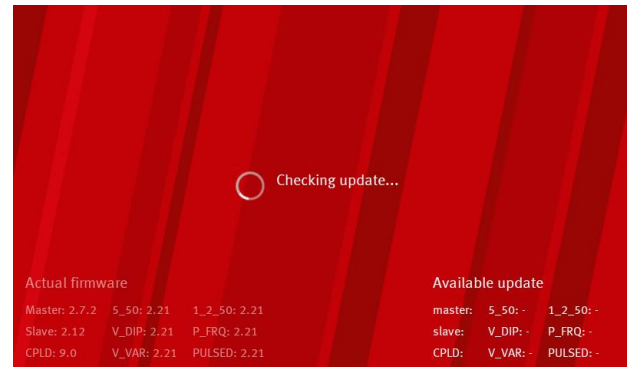

10. The available firmware updates are installed automatically on the compact NX generator.



The update processing is indicated and may need several minutes to complete.

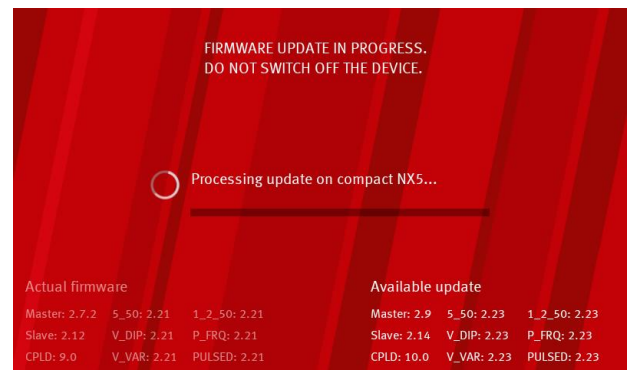

11. After successfully update remove all USB memory sticks and

Switch OFF / ON the device

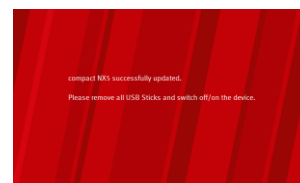

12. After switch on the final firmware update is installed and configured.

DO not switch OFF while updating

After the update the system is loading the devices

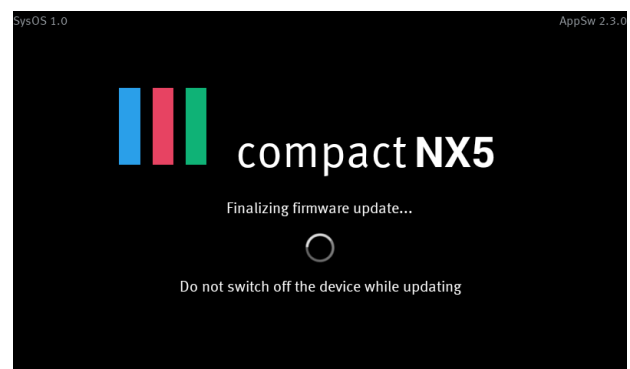
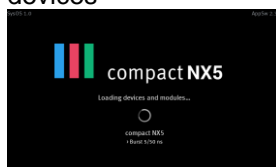

3.6.2. Software Update Install SysOS



Important

Before **install a new SysOS**,

Save the system settings on an external USB memory stick with the function **Export Settings**.

The update SysOS will set all settings to factory setting

- EUT settings
- All settings in SETUP GENERAL
- All settings in SETUP EQUIPMENTS
- All Link tests, User tests, Customized Standards

Make sure that you have done the Chapter 3.6.3. Export actual settings

Software Update procedure

1. Select **MENU / SETUP**



Software Update procedure

2. **Remove all USB Sticks** from the System and Click on **UPDATE SYSOS**

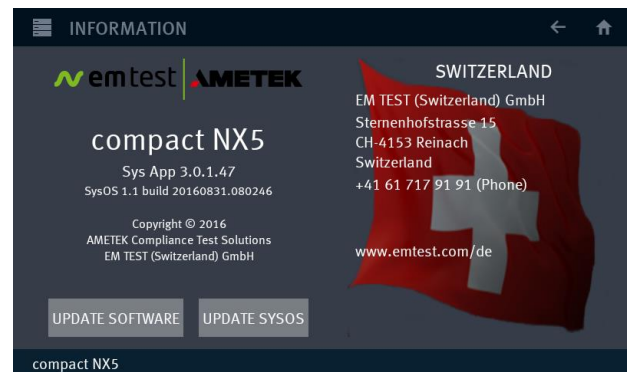

3. **Insert the USB Stick** containing the update files in the compact NX5 (front or back). Update file will be automatically detected and analyzed. This may take a minute.

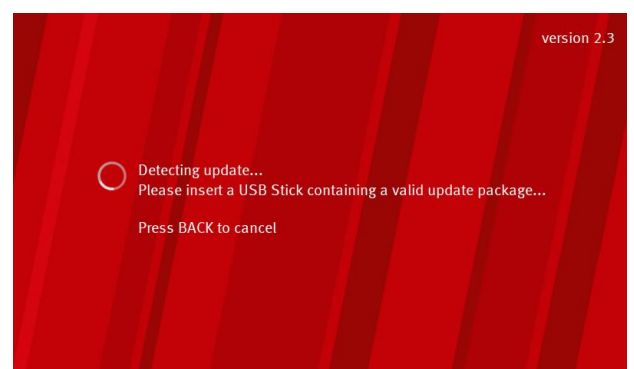

4. Once the update package has been checked, click **INSTALL** to proceed.

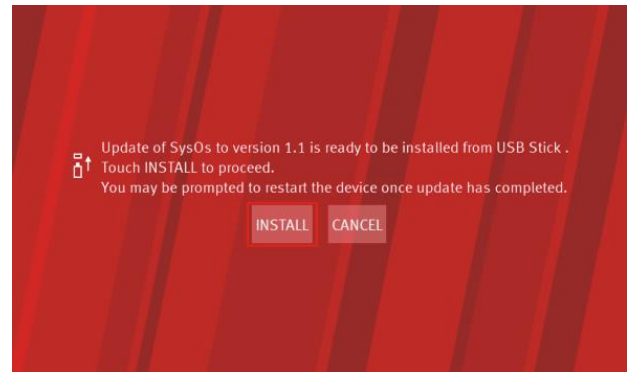

5. The update is then prepared but will need a System reboot to proceed.

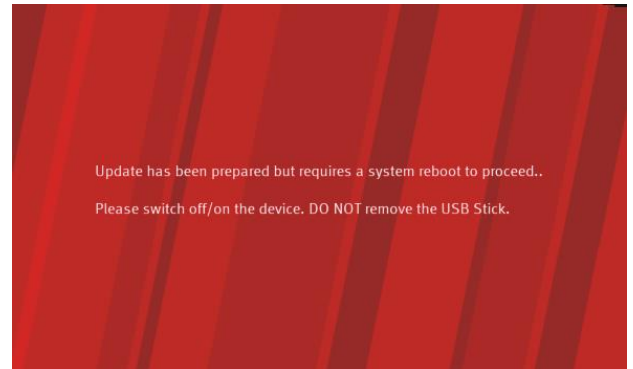

6. **DO NOT REMOVE** the USB Stick from the device and
- **Switch OFF** the compact NX,
 - **wait 5 seconds** and
 - **switch it ON** again.



7. A few seconds after restarting the device, you should see the following screen. Please wait until update process completed. This may take a few minutes.



8. Once update has completed and the following screen appears
- **remove all USB Sticks,**
 - **Switch OFF** the compact NX,
 - **wait 5 seconds** and
 - **switch it ON** again.

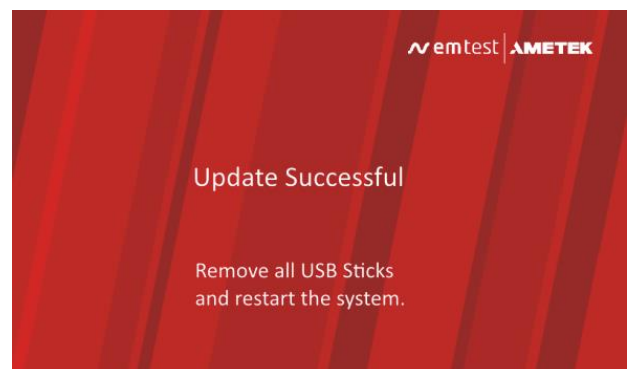

3.6.3. Export actual settings

The Export settings saves all device settings on an external USB Stick. It is strongly recommended to export the settings before doing a SysOS update.

Export settings procedure

1. Select **MENU / SETUP**

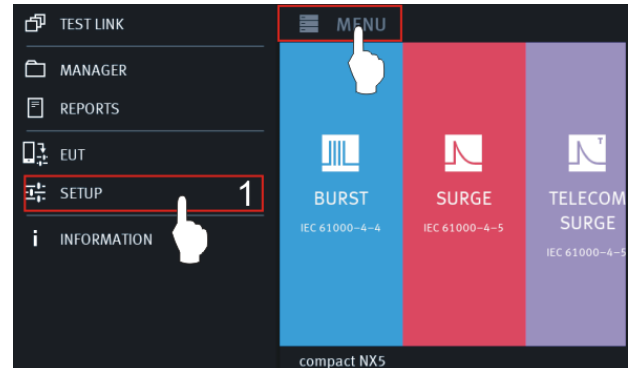

2. Press **System**

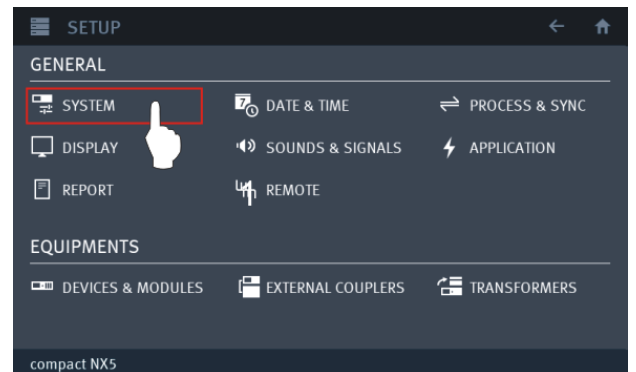

3. Insert **USB Stick** to the front USB slot

After few seconds the Backup settings button will automatically be enabled.

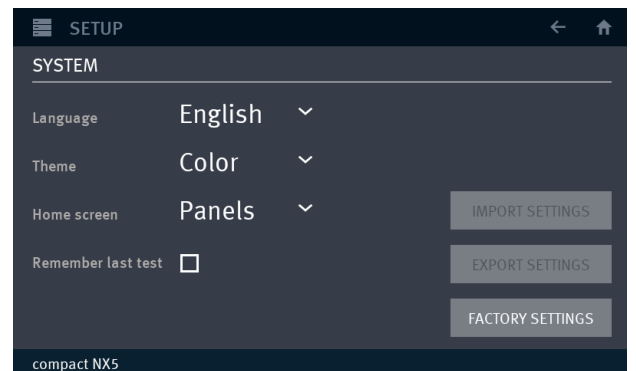

4. Click on **Backup Settings**

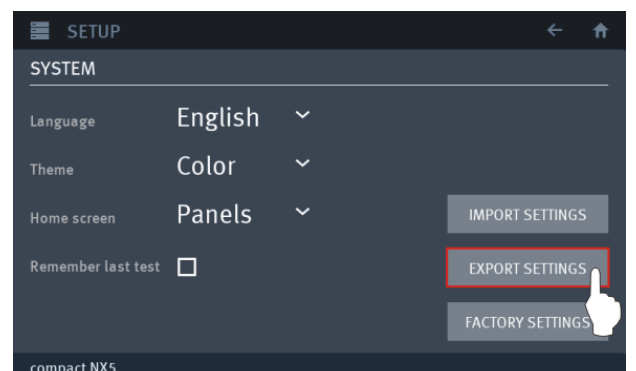

5. Select the folder where you want save the backup setting files

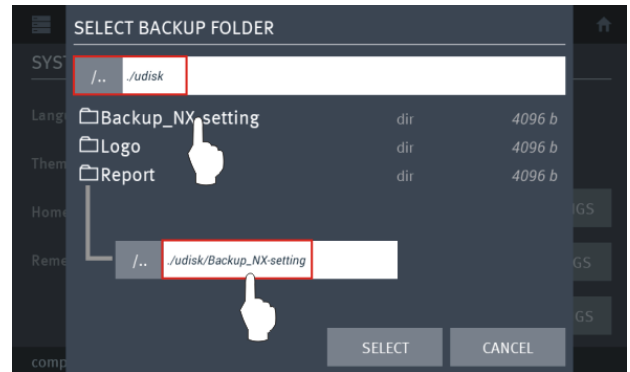

6. A message indicates the backup writing to the USB stick.

A message on the bottom of the screen confirms that the backup has completed.

Filename is **syssettings.bkp**

Remove the USB Stick from the generator compact NX

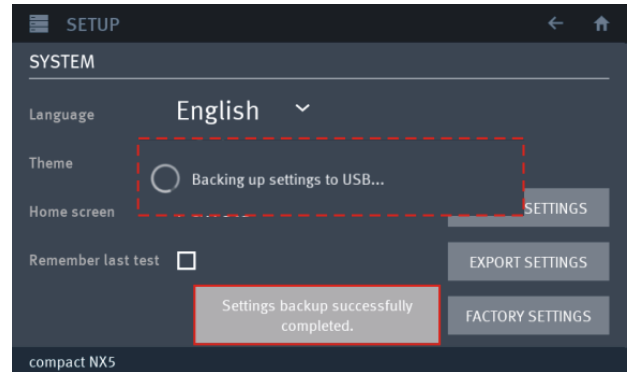

3.6.4. Import the settings

The Import settings restores all device settings from an external USB Stick. It will reinstall all device settings after a SysOS update.

1. Select **MENU / SETUP**

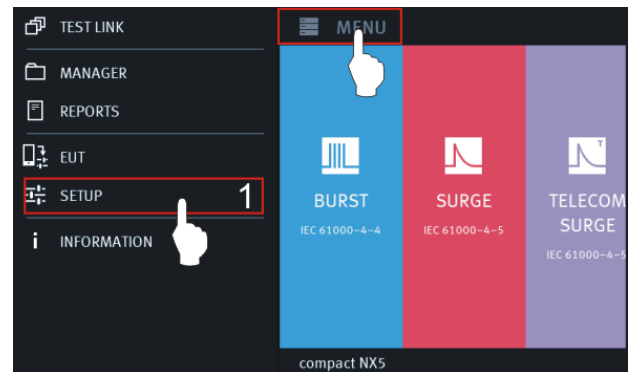

2. Press **Update Software**

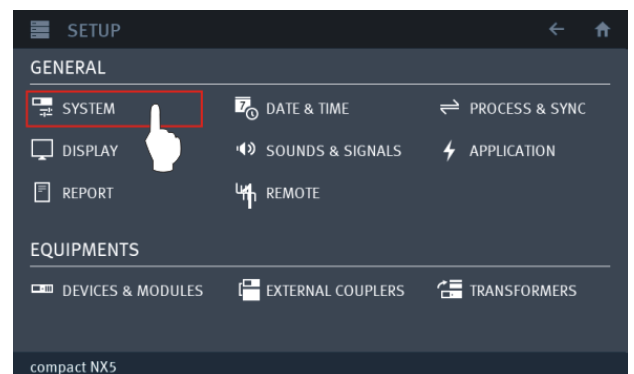

3. **Insert USB Stick** to the front USB slot

After few seconds the Backup settings button will automatically be enabled.

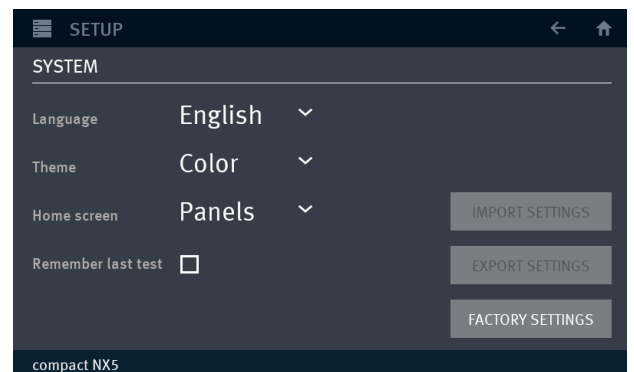

4. Click on **Import Settings**

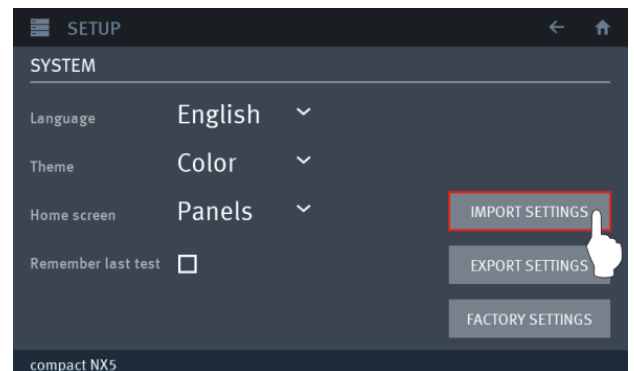

5. Press Front

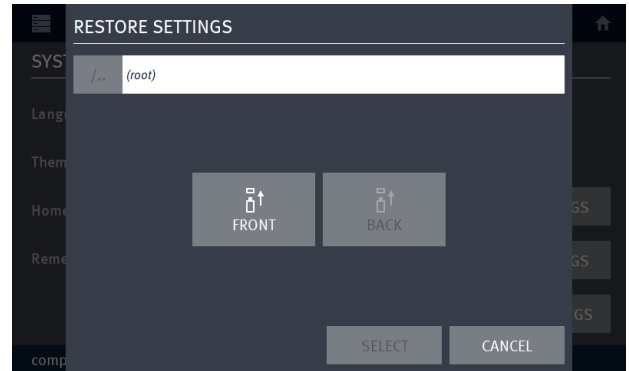

6. Select the backup file (syssettings.bkp) and click **SELECT**.

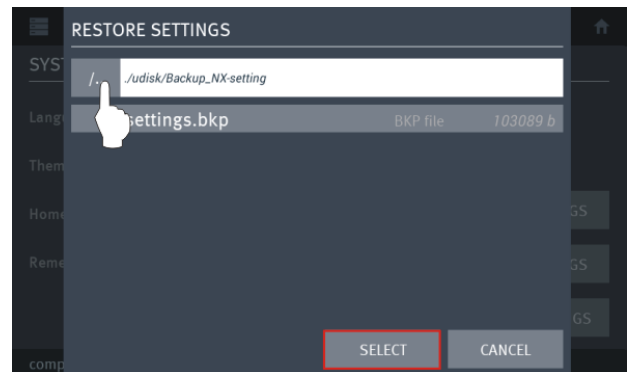

7. Remove all USB Sticks and Restart the compact NX, the initialization process will start normally and take you to the Home Screen.

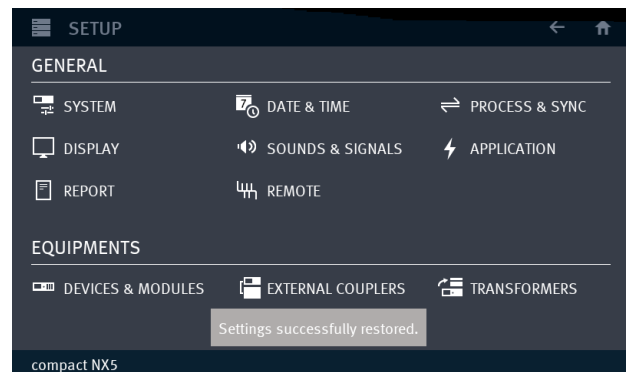

3.6.5. Manual Firmware Update

Firmware Update procedure

1. Select MENU SETUP / DEVICE & MODULES

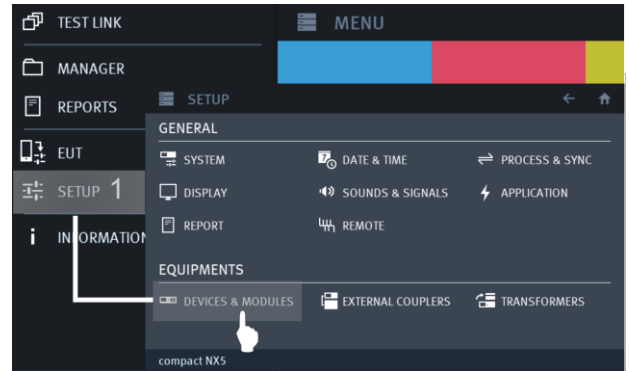
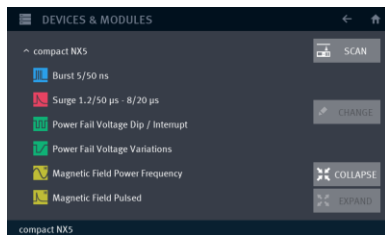

2. Insert the memory Stick with the update software in the root
A message for search the memory stick appears until the memory stick is recognized.

Firmware filename: *.upt

3. Make **click**, a **long click** to compact NX5 or press **change**
4. Press **Update Firmware**
The program search the firmware update on the memory stick

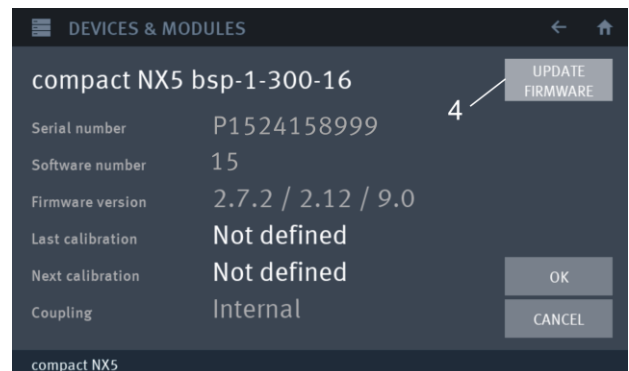
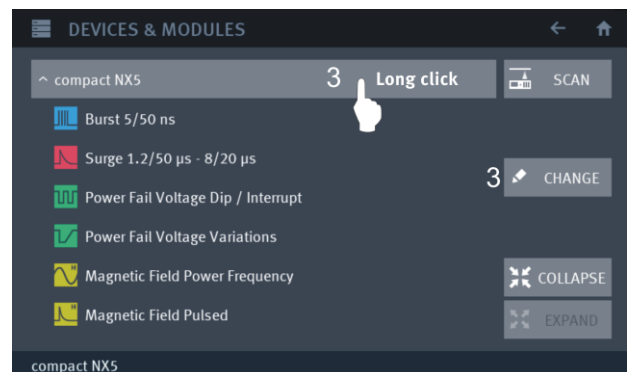

The device shows the actual and recognized new firmware version

If no USB stick is detected

Insert a USB stick containing valid update package

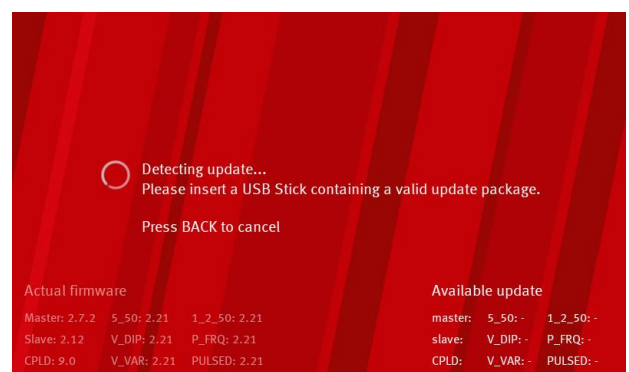

The device shows the actual and recognized new firmware version

5. Press **INSTALL** for start the update procedure. The update process is shown on the screen and needs several minutes.

Press **CANCEL** to exit

Exclude Downgrades will not install older versions, when detected on the USB stick

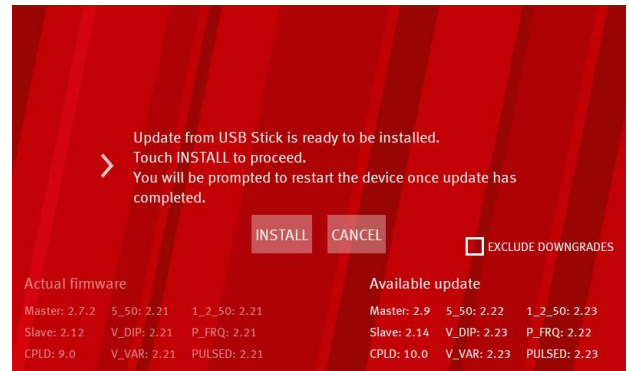

6. After display "*Update successfully done*",
 - **remove** all USB Sticks
 - **switch off / on** the device

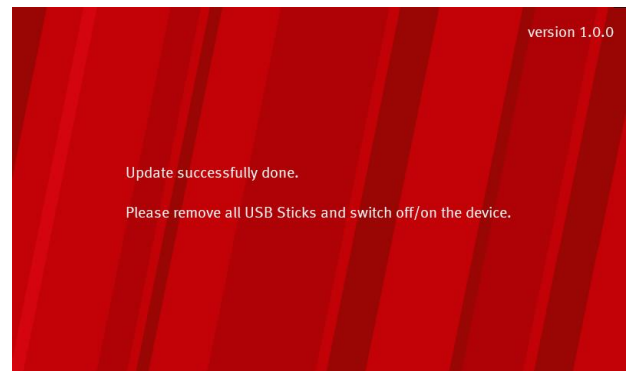

After the rebooting the device starts with the new firmware.

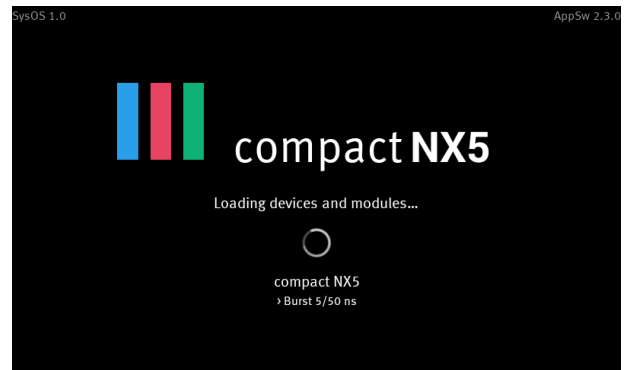

4. Design and Functions

4.1. Front view



1	Active indication	6	CRO V (surge)	11	CRO Trigger output \uparrow 5V
2	Touch screen	7	HV pulse Burst output 50 Ω	12	Start / Pause
3	Knob (Inc. / Dec /Enter)	8	Coupling (Power, Burst, Surge)	13	Stop
4	" Test On"	9	EUT test supply	14	Back
5	CRO I (surge)	10	Ground reference (calibration)	15	USB input (Memory stick)

1 ACTIVE

Indicates that this unit is active

2 Touch screen and user interface

With the 7" capacitive touch screen display the user controls the equipment. The display indicates the status of the generator and test equipment.

3 Wheel (Inc. / Dec / Enter)

Rotate for increments or decrements a selected parameter. Push change the digit and hold with a numeric value or selects from a list of parameters. Press to change adjustment range. Selected range will be shown briefly next to selected parameter. Push and hold to "zero" to nearest range.

4 Test On

By pressing the key "Test On" follows the functions:

- Activate the high voltage power unit; HV is ready to start.
- Switches ON the supply to the EUT test supply (only with built in Power Fail module).

5 CRO I (surge)

At the BNC output the current pulse (surge) of the generator can be measured galvanic separated.

- Impedance measuring instrument: $>1M\Omega$.
- Max. output voltage: $10V \pm 10\%$ at 2.5 kA output current.

6 CRO V (surge)

At the BNC output the voltage pulse (surge) of the generator can be measured galvanic separated.

- Impedance measuring instrument: $>1M\Omega$.
- Max. output voltage: $10V \pm 10\%$ at 5 kV impulse voltage.

7 HV pulse burst output 50 Ω

External coupling devices such as the capacitive coupling clamp and the 3-phase coupling networks are connected to the coaxial 50 ohm output. Also the calibration of the generator is handled at this output.

Note: The burst signal is present on this output at every coupling mode.

8 Coupling mode

The LED indicates

- actual coupling mode of the Burst or Surge impulse to lines L, N, PE, or + for dc
- active power supply source PF1, PF2



- | | | | | | |
|---|--------------------------|----|-----------------------------------|----|----------------------------------|
| 1 | Active indication | 6 | CRO V (surge) | 11 | CRO Trigger output \uparrow 5V |
| 2 | Touch screen | 7 | HV pulse Burst output 50 Ω | 12 | START / PAUSE |
| 3 | Knob (Inc. / Dec /Enter) | 8 | Coupling (Power, Burst, Surge) | 13 | STOP |
| 4 | " Test On" | 9 | EUT test supply | 14 | BACK |
| 5 | CRO I (surge) | 10 | Ground reference (calibration) | 15 | USB input (Memory stick) |

9 EUT test supply

For single-phase EUT the coupling/decoupling network is part of the generator. The EUT is powered via the safety banana plugs at the front panel of the simulator.

10 Ground reference

The ground reference (4mm) is used for EFT/Burst calibration adapters.

11 BNC - CRO Trigger

At the BNC output the generator trigger can be checked, e.g. the burst duration, the burst repetition rate and the spike frequency (+5 V rectangular). This output can be generally used as oscilloscope trigger output and is synchronous to the following events.

- Burst and surge release
- Voltage dip or interruption, start of the event.

12 START / PAUSE button

- Green indication: Start or continues a test
- Orange indication: Pause of a running test

13 STOP / Pause button

- Red indication: Stop a running or paused test.

14 BACK button

- Returns from a stopped test to the input screen.
- Same effect with two fingers swipe on the screen, slide them from right to left

15 USB input (Memory Stick)

Input plug for a memory stick for export / import test reports or test and link-files. The user can load from this port setup pictures, updates and other files to the Compact NX5 generator.

4.2. Rear view

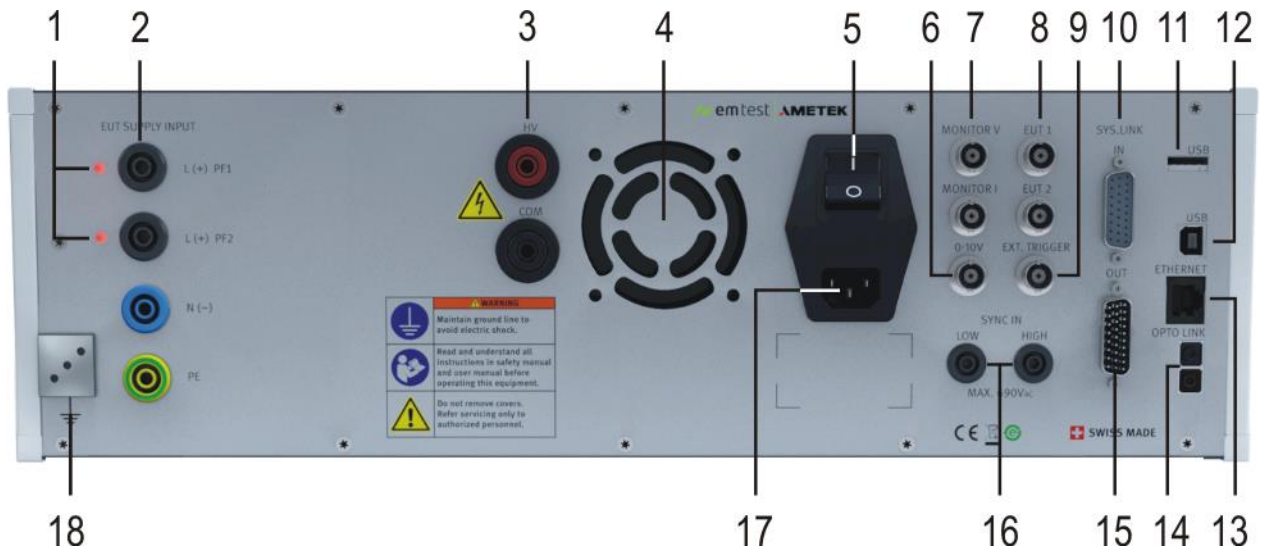

- | | | |
|------------------------------|------------------------|-------------------------------|
| 1 Phase indication PF1 / PF2 | 7 Monitor V, Monitor I | 13 Ethernet interface |
| 2 EUT supply input | 8 Fail, EUT 1, EUT2 | 14 Opto Link Interface |
| 3 Surge output HV - COM | 9 External Trigger IN | 15 Sys Link OUT |
| 4 Ventilator | 10 Sys Link IN | 16 Sync input |
| 5 Mains Switch | 11 USB A interface | 17 Mains input device |
| 6 DC output 0-10V | 12 USB B interface | 18 Reference earth connection |

1 Phase indication

Phase indicator for PF1 and PF2 input with reference to PE. To guarantee correct phase angle synchronization, the red lamp must illuminate. Otherwise the phase angle setting is 180 degree inverted.

2 EUT supply Input PF1, PF2, N, PE

Input plug for the EUT power supply (4mm safety banana plug). The input is not fused. The internal power fail switches (PF1, PF2) protect the system against overcurrent and are configurable.

- PF1: Mains voltage to EUT phase L
- PF2: Reduced dip voltage to EUT phase L (used for dip voltages as per IEC 61000-4-11)
- N: Neutral to EUT supply
- PE: Protected earth to EUT supply

3 HV and COM output

The direct HV and COM outputs are floating output plugs for surge impulses.



Attention

The direct HV and COM output of the surge generator is located at the rear panel of the generator. It is not allowed to connect these outputs to any other coupling/decoupling network than manufactured by EM TEST. Before to connect any external networks to this output the operator must contact the manufacturer. Any damages due to this matter are not covered by warranty.

The direct pulse output shall also not be used to connect the generator directly to any power conducting lines

The wave shape measured at the direct pulse output must not be within the tolerances specified in IEC 61000-4-5. The pulse shape shall be verified at the CDN output directly, no matter whether it is an internal or external CDN.

4 Ventilation

A power controlled ventilator is cooling the compact NX5 generator. During the most application the ventilator runs with variable speed depends the cooling requirement. After long term duration tests the generator should keep on running for some minutes to cool down the system.

5 Power on switch

The switch is part of the mains filter. Mains fuses are part of the filter. (230V / 2A and 115V / 4A)

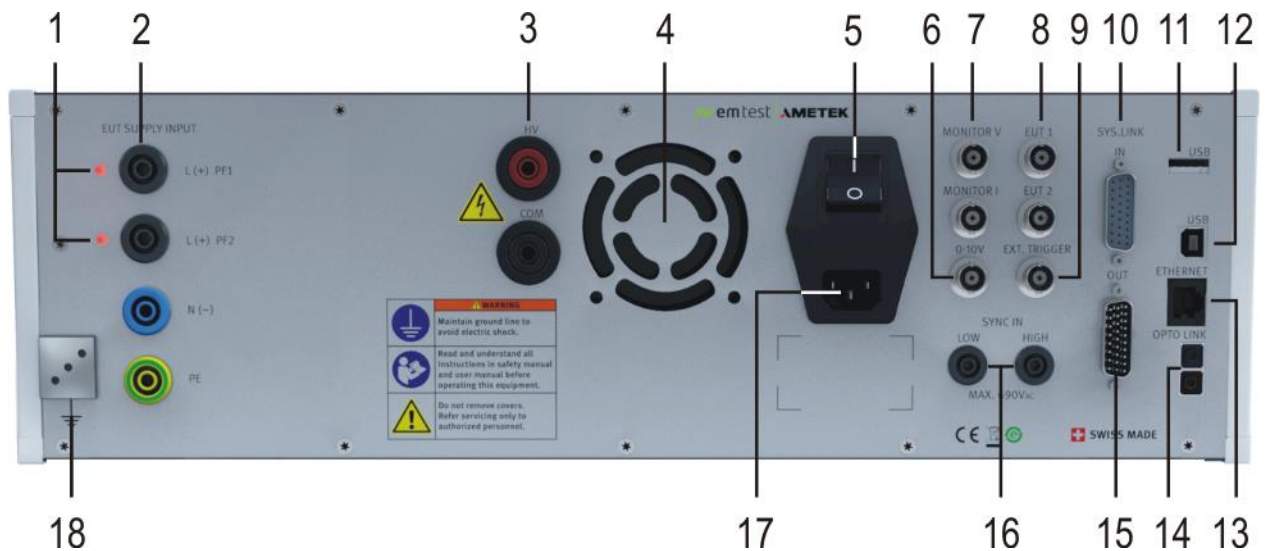

- | | | |
|------------------------------|------------------------|-------------------------------|
| 1 Phase indication PF1 / PF2 | 7 Monitor V, Monitor I | 13 Ethernet interface |
| 2 EUT supply input | 8 Fail, EUT 1, EUT2 | 14 Opto Link Interface |
| 3 Surge output HV - COM | 9 External Trigger IN | 15 Sys Link OUT |
| 4 Ventilator | 10 Sys Link IN | 16 Sync input |
| 5 Mains Switch | 11 USB A interface | 17 Mains input device |
| 6 DC output 0-10 V | 12 USB B interface | 18 Reference earth connection |

6 DC output 0-10 V

Dc output for control an external AC source.
 0.0 V = zero position
 10.0 V = max. position for maximum voltage

7 Monitor V and Monitor I (BNC connector)

BNC output for measuring the EUT supply voltage and supply current
 Impedance measuring instrument: $\geq 1M\Omega$.
 Accuracy: 5%

Monitor V:

Voltage output: 10 V = 300 V rms, 450 V peak
 Internal divider: 42.5 : 1

Monitor I:

Current output: 10 V = 16 A rms,
 Internal divider: 2.26 A/V
 Max. 16 A rms, max. 25 A dc

8 Fail input EUT 1, EUT 2

Programmable input monitors for fail events. Possible input settings: Notify, Stop, Break or Disabled
 Input signal: 5 V pos. slope
 Max- Input voltage: +24 V

9 External trigger

One single event, burst, surge, voltage dip can be released. Trigger level 5V positive going.
 BNC connector 50 Ω
 Digital Input (0 – 5 V)
 Positive slope
 Trigger Level: 2.5 V +/- 1 V
 Max- Input voltage: +24 V

10 Sys Link input

Sys link is the internal control bus to the connected compact NX devices. The sys link is a daisy chain wired bus for connect the devices in series. The bus includes a 26 pole high density connectors. This port is terminated with the **SSC AD** Safety circuit adapter with a short circuit.

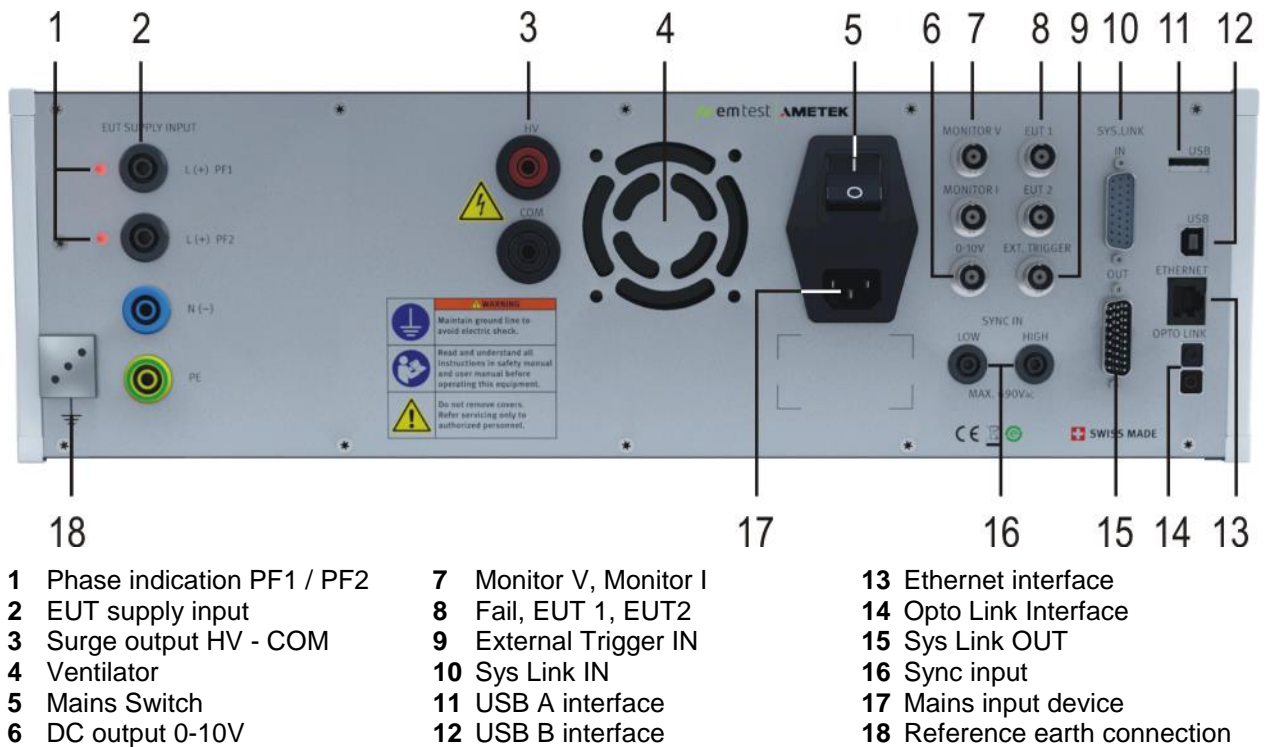

11 USB interface (for service purpose)

USB interface "USB A" connector for remote control from an external computer. Using the USB interface may cause EMC problems during burst tests at the computer or notebook side of the communication line. Therefore only a high quality USB cable shall be used.

12 USB interface (for service purpose)

USB interface "USB B" connector for service purpose with an external computer. Using the USB interface may cause EMC problems during burst tests at the computer or notebook side of the communication line. Therefore only a high quality USB cable shall be used.

13 Ethernet interface

Ethernet interface for remote control from an external computer.

14 Opto Link interface

Ethernet interface for remote control from an external computer.

15 Sys Link output

Sys link is the internal control bus to the connected compact NX devices. The sys link is a daisy chain wired bus for connect the devices in series. The bus includes a 26 pole high density connectors. This port is terminated with the **SWL AD** (Safety Warning Lamp Adapter).

16 SYNC input (External)

External synchronization input for synchronize the generator impulse to this signal.

Input signal range: 10 V – 690 V.15Hz to 500 Hz

For each test with synchronization the generator measures the frequency. If no signal is detected, a window will propose to continue in asynchronous mode.

Internal synchronization detects the signal from input L of the channel PF1.

17 Mains Input and Fuse

Mains input for the generator power supply.

Input voltage: 85 V – 254 V ac

Fuses: 115 V: 4 A slow blow, 5 x 20 mm.

230 V: 2 A slow blow, 5 x 20 mm









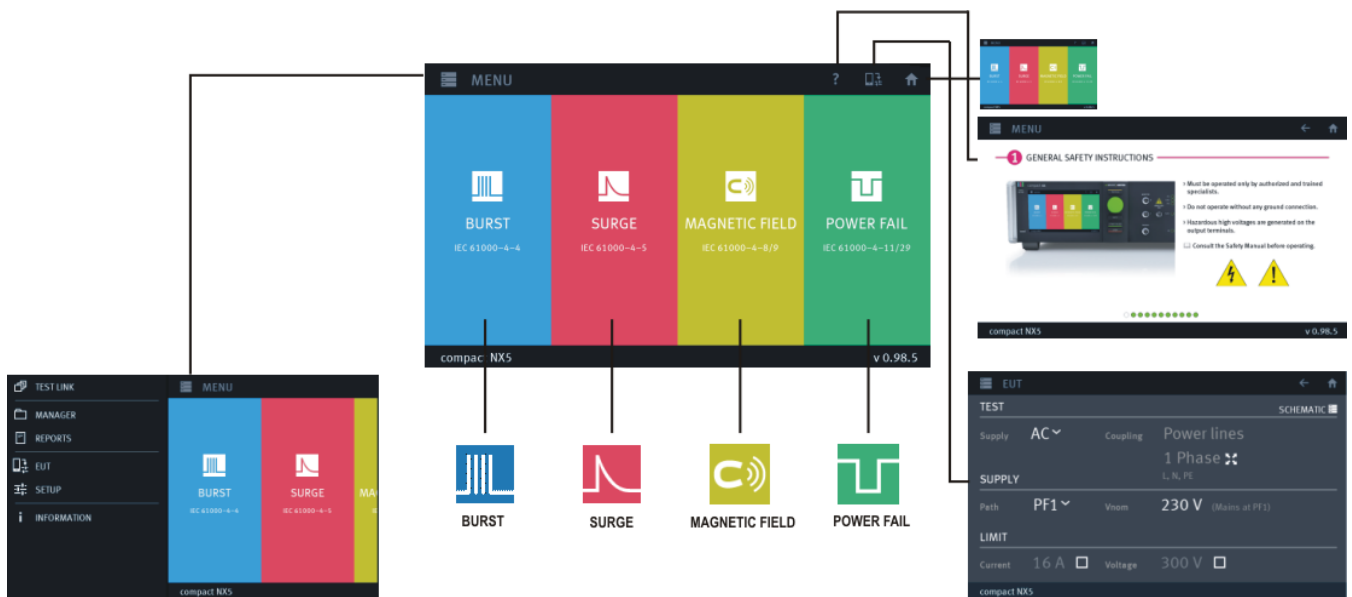





18 Reference earth connection

The generator has to be connected to the reference earth plane of the test set up. The connection at the rear part of the generator is an alternative to the grounding point at the front panel

4.3. Menu description

4.3.1. Main Menu



	Home Returns to the Home screen
	Help Shows the Quick Start Guide for a brief information for NX5 generator operation
	EUT and Supply configuration - EUT configuration (power line arrangement / data lines) - Test supply and coupling - Supply Path and voltage - Limiter for EUT current and voltage
	Menu Setting: Opens the menu for general settings Test Link Configuration of test link procedures Manager Test files management for test library configuration EUT Configuration of EUT and EUT supply Setup General setup compact NX5 and configuration of auxiliary test equipment Modules List of all available pulse modules Information Device name, Software and firmware version, address of representatives
	Test phenomena Touch into the colored field for select and load a test. The icon shows the kind of test phenomena. <ul style="list-style-type: none">  Burst impulse test 5/50 ns as per IEC 61000-4-4  Surge impulse test 1,2 /50 μs as per IEC 61000-4-5  Telecom Surge test 10/700 μs as per IEC 61000-4-5  Magnetic field test <ul style="list-style-type: none">  Power magnetic field as per IEC 61000-4-8  Pulsed magnetic field as per IEC 61000-4-9  Power Fail tests <ul style="list-style-type: none">  Dips and interruptions IEC 61000-4-11 / 29  Voltage variation as per IEC 61000-4-11

4.3.2. Menu Setting

Each test phenomena is operating similar. The next section shows the basic operation for perform a test.

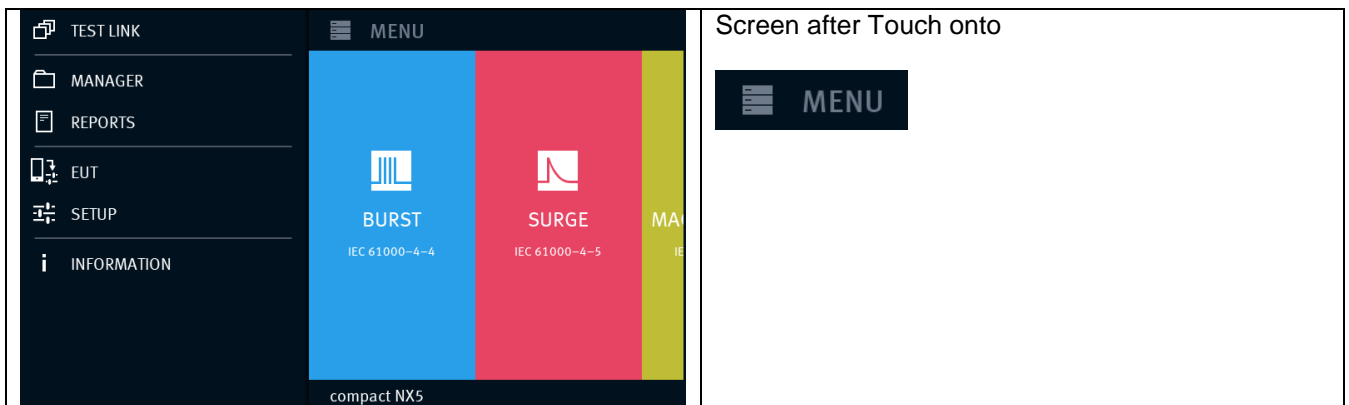

Screen after Touch onto



TEST LINK



In this menu the user creates and complete his own test Link
A Link Test is generated from

- Test files, loaded from the library (Burst, Surge,...)
- Pause or messages with information to the test
- Save or load any test

Manager



The user configures in this menu the library Manager of all existed test files.

- Rename of tests
- Mark as visible or hide
- Remove test from the library
- Import and Export of test

Reports

15.3. Report Export

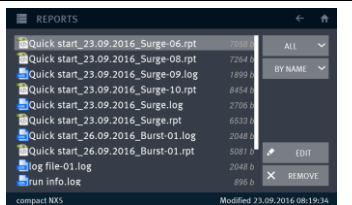

Report Menu for export Report and Log files:

- Report as *.rpt
- Report as *.pdf
- Report as *.rtf
- Report aRun Information as *.log

EUT

4.3.5. EUT Setup

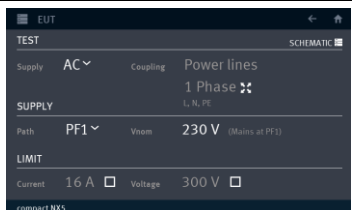

EUT and Supply configuration

EUT Configuration and Setup for the test.

The generator uses the settings and offers exact the needed information for the EUT. All needless information will not be displayed

Setup

4.3.6. Setup

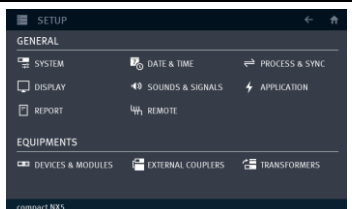

Setup

General setup for Compact NX5 settings

- System, Date/Time, Process & Sync
- Display, Sounds & Signals, Application, Report; Remote,

Equipment setup for

- External couplers, Transformers

Information



System Information

- Device Version, Firmware, Software
- Representative address EM TEST / AMETEK CTS offices, when touch the national flags
- CH, Germany, USA, Poland, France, Italy, Austria, China, Japan
- Software update (3.6. Software Update)

4.3.3. Test phenomena



Every phenomenon is supported by a color code. Touch into the colored field for select and load a test. The icon shows the kind of test phenomena.



Burst impulse test 5/50 ns as per IEC 61000-4-4



Surge impulse test 1,2 /50 μ s as per IEC 61000-4-5



Telecom Surge test 10/700 μ s as per IEC 61000-4-5



Magnetic field test

power magnetic field as per IEC 61000-4-8

Pulsed magnetic field as per IEC 61000-4-9



Power Fail tests

Dips and interruptions IEC 61000-4-11 / 29

Voltage variation as per IEC 61000-4-11

The phenomenon offers up to five different test modes.

USER TEST and EASY LINK with lighted symbols are libraries that includes at least one test. An Empty library is marked with gray color and includes actually no test (e.g. EASY LINK).

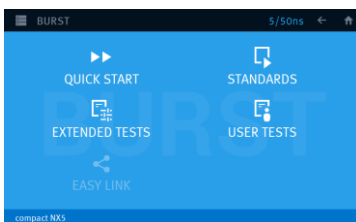

Quick Start: Manual operating with online changing of parameters

Standards: Library with Basic- and Generic Standards. The Standards are separated in Power AC, Power DC, and Signal lines. Each Basic Standard includes all existing levels.

Extended Tests: Test procedures with useful sequences like voltage iteration

User Tests: User configured test library. These tests can be used in any link files.

Easy Link: Temporary storage of test files of the phenomenon. Easy Link files are deleted after switch off the device.

Power Fail

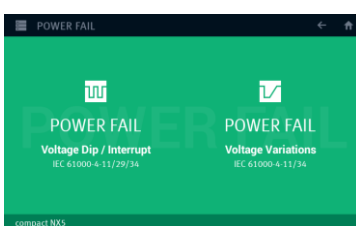

Power Fail offers two different phenomenon test procedures. The screen shows both tests.

Select a test you like to perform for open.



Voltage Dip / Interrupt



Voltage variation

Magnetic Field

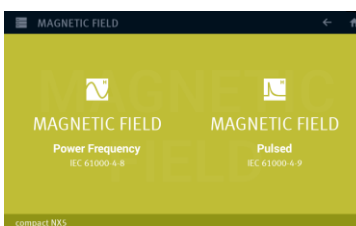

Magnetic field offers two different phenomenon.

Select a test you like to perform for open.



Power Frequency as per IEC 61000-4-8



Pulsed as per IEC 61000-4-9

4.3.3.1. Parameter setting

All phenomena offer similar parameter setting procedures. The figure below explains the different actions for parameter setting.

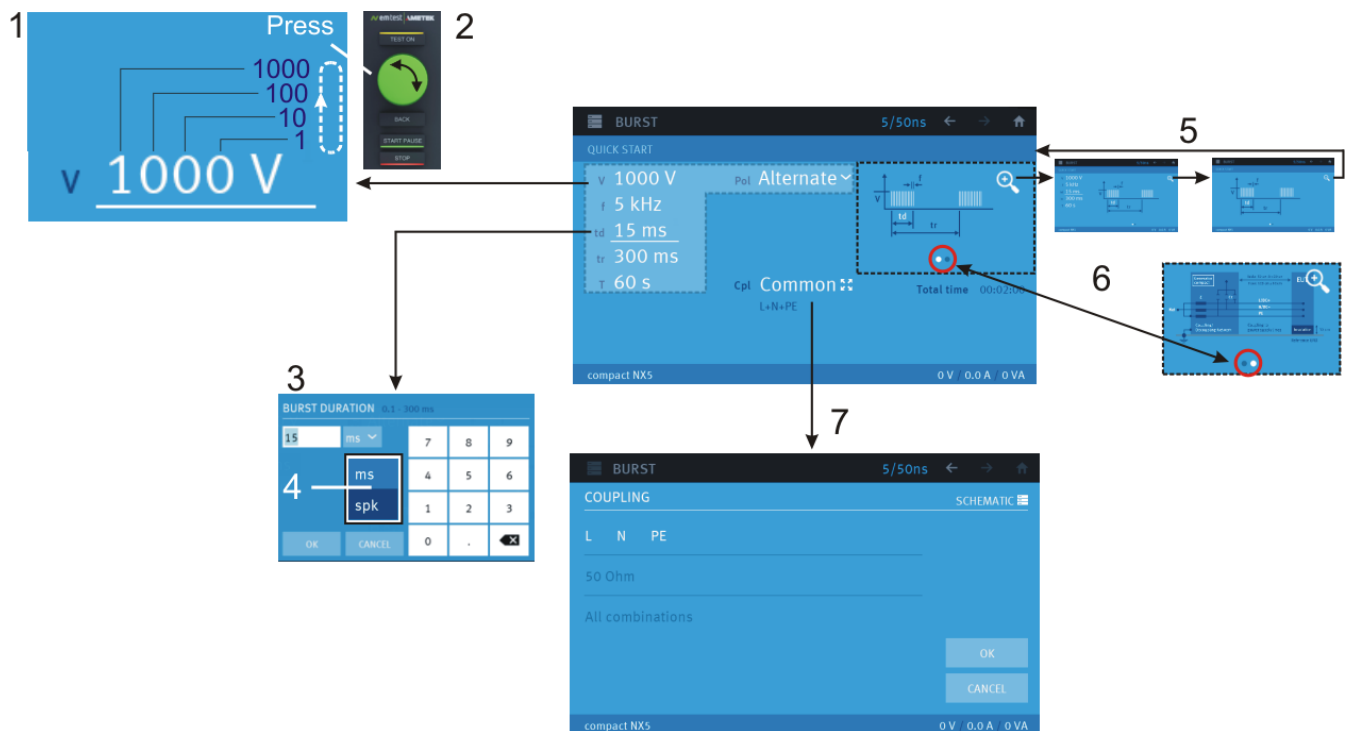

1 Parameter change

All white colored parameters are changeable. Blue colored parameters are normally defined by the used standard and fixed. For change a parameter proceed the following:

Touch into the parameter you like to modify

The selected parameter is marked with underline 1000 V¹. The ¹ indicates the digit that changes using the wheel.

2 Parameter modification with the wheel

- **Rotate** the wheel: **Increase** or **decrease** the selected digit. Depend on the parameter the digit is defined.
 - **Press** the wheel: Will change the digit, press again for the next digit. This will rotate the digits cyclic (1, 10, 100, 1000, 1, 10, ...). A small value indicates the selected digit that will be controlled by the wheel.
 - **Long press** wheel: All digits right will be replaced by a zero. Example

$v\ 1469V \xrightarrow{1\ s} v\ 1000V$

3 Parameter modification with the touch

A numeric display, with the parameter description and his limits appears at the screen.

- **Parameter:** **Enter** the new value of this parameter.
- **OK / CANCEL** Terminate the parameter input
 - **OK** replaces the parameter with the new input value
 - **CANCEL** keeps the old value

4 Parameter unit modification

Some parameters allow changing the unit as (ms / spikes) or (μ s / ms / s) or (% / V) for the test procedure. Select the desired parameter unit for perform the test

5 Picture Loupe function

Touch the loupe symbol or **double tap** the figure for magnifying the picture. There are three magnifying steps rotating the size.

It is possible to add new pictures in this picture gallery.

6 Picture change

The dots below the picture indicate the number and position of available  pictures. Slide left or right through the picture for change to the next / previous picture.

7 Coupling screen

Touch the coupling symbol  for open the coupling screen. The screen offers all options for change the coupling. See to the phenomenon description for more information.

4.3.3.2. Set and test window

The screen for each phenomenon separated in two different screens. The figure below illustrates the state machine during the testing.

SET screen: Screen for setting all test parameters (yellow circle).

TEST screen: Screen during a test is running. After the **START** the user can **PAUSE** and **START** (Resume) or **STOP** the test (grey circle)

Testing: Test is running

Break: Test is paused and can be continued with start

Resume: Test is running and continued after a break

Stop: Test is stopped during running or at a break. The test is not completed with all test sequences. A stopped test cannot be continued.

Finished: The test is completed and terminated with all test sequences

4.3.4. Test and Run Window

Test Window

In the test window the user can enter the parameters of the test. Further it is possible to change in another test menu and to save the test as Easy Link or User test.

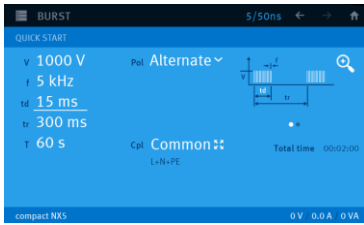

Test window

The window shows all parameter for the test. The underlined parameter **15 ms** is the parameter that can be changed with the wheel. A graphic shows the focused parameter.

- Touch to a white colored parameter for select and change
- Rotate the wheel for parameter value change

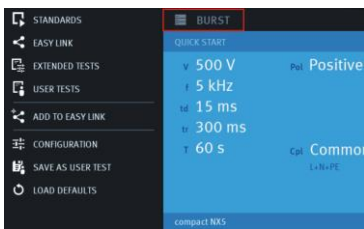

Test Window Menu

Menu functions:

- Change to Standards, Easy Link, Extended Tests, User tests
- Add the actual test to Easy Link
- Configuration menu
- Save the test as User Test
- Load default test settings

Run Window

The run window is active from the Start of the test until the user press the **Back** or **←** button after a stop or when the test is finished. It is possible to return into the Run window with the button **→** as long as no parameter has changed in the Test Window.

In the Run window the user can view the run information and save the report or run Information.

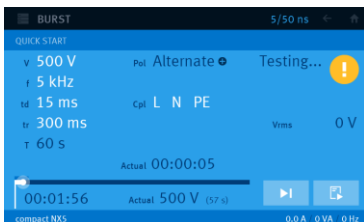

Run window

The run window shows the following information

- **Set parameters:** Parameter color; white changeable, blue fix parameters
- **Run Status:** Testing, Break, Stopped, Finished
- **Graphic bar:** Indicates running time of actual setting and total test time
- **Time:** Time of actual setting and total test
- **Measuring:** EUT parameters (voltage, current, power, frequency)

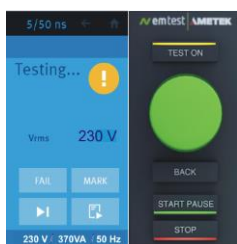

Test control buttons

- START / PAUSE** Starts, pause and continues the test after a pause
- STOP** Stops a test. The test is finished
- BACK** Return to the test window for change parameters
- Step to the next test sequence (e.g. coupling, polarity)
- Report functions enable**
- FAIL and MARK** function for Report event

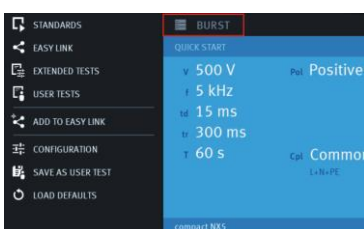

Run Window Menu

Menu functions:

- View Run Information
- Save Report
- Save Run Information
- Configuration menu

Block diagram for a test

Test window: Yellow background
 Run Window: Grey background

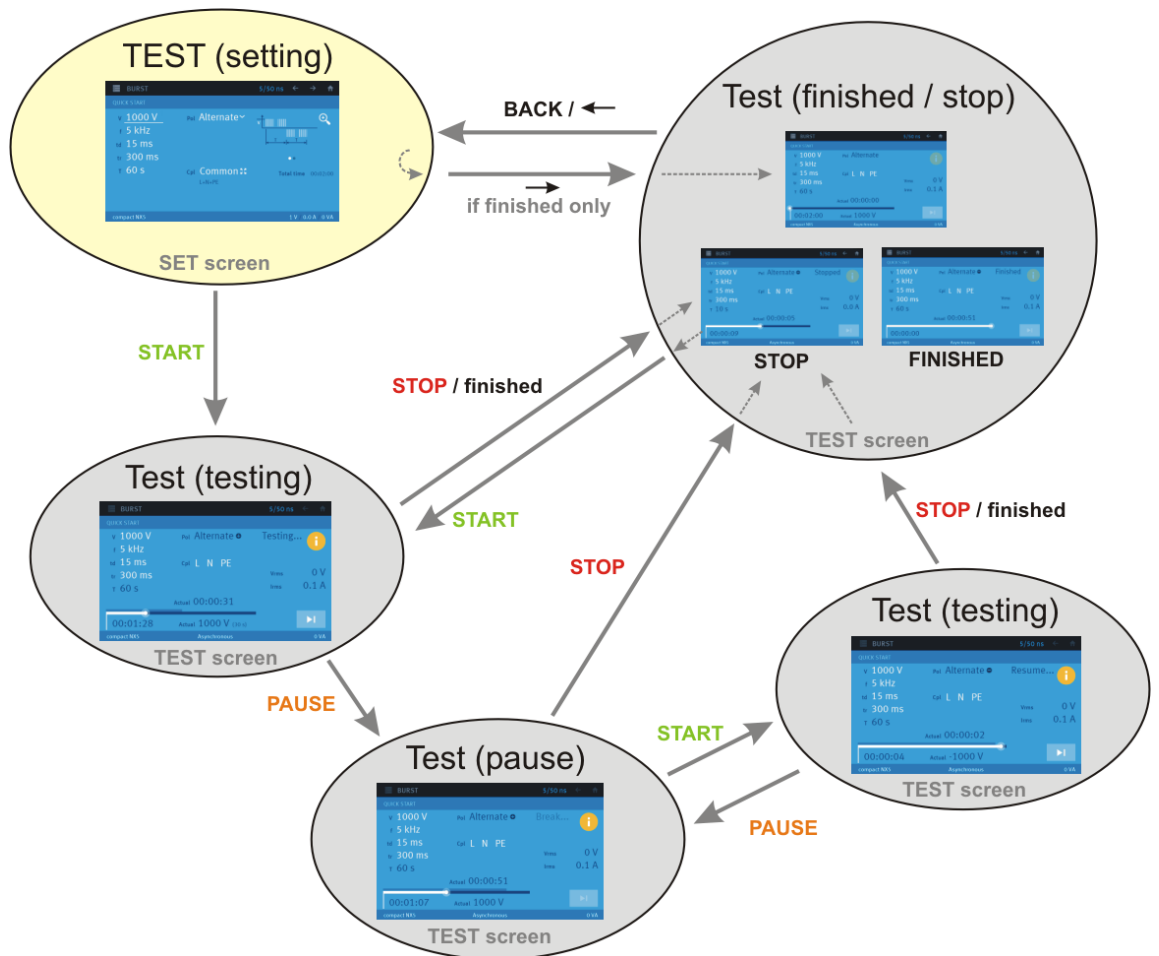

State machine for the generator screen during a test sequence

Test window Menu

4.3.4.1. Run Window Menu

The run Window Menu offers the following functions. The most functions are available in all phenomenon.

View Run Information

Run log table where all parameter changes and events during the test are logged.

Save Report

Save the report to

- Ext. USB Stick as a *.pdf file
- Ext. USB Stick as a *.rtf file
- Internal in the device as *.rpt file

Save Run Information

Saves the run information internal to the device as log file. The file can be export in the main menu

Configuration

Trigger- and Monitor configuration



Peak Limiter

Setting of Peak current Limiter

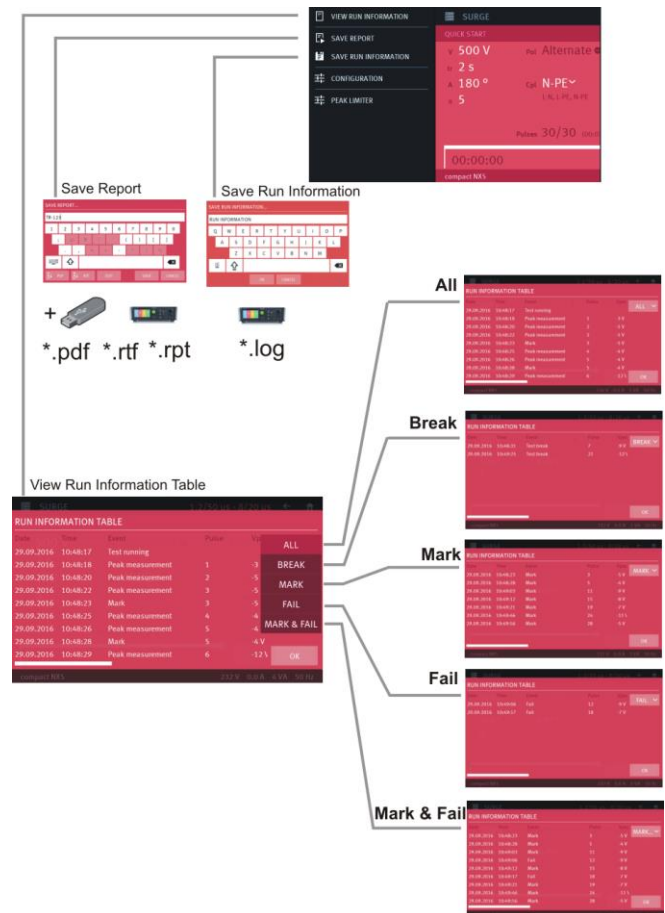

4.3.4.2. Run Window at test end

After running a test, the VIEW RUN INFORMATION shows all run information during the test. The list shows:

- The actual date and time of the event
- All parameter settings and their changes
- Measurements like peak voltage or peak current
- Events like Mark, Fail and breaks

A Filter separates the log table by: **All**, **Break**, **Mark**, **Fail** and **Mark & Fail**

4.3.5. EUT Setup

In the EUT Setting the user specified his EUT. With this information the compact generator software will configure all settings to the EUT requirements.

The user defines:

- Mode of supply voltage (AC/DC)
- Configuration of the EUT supply wiring
- Default channel for the power supply
- The mains supply voltage
- Current and Voltage limit and their settings

Advantages are:

- Select only set the possible couplings and hides all unnecessary settings for the user
- Filters the standard tests adapted to the EUT like AC 50Hz, AC 60 Hz, DC.
- Set the motor variac to the settled nominal voltage

Select EUT setting menu

Figure below shows how enter into the EUT setting menu

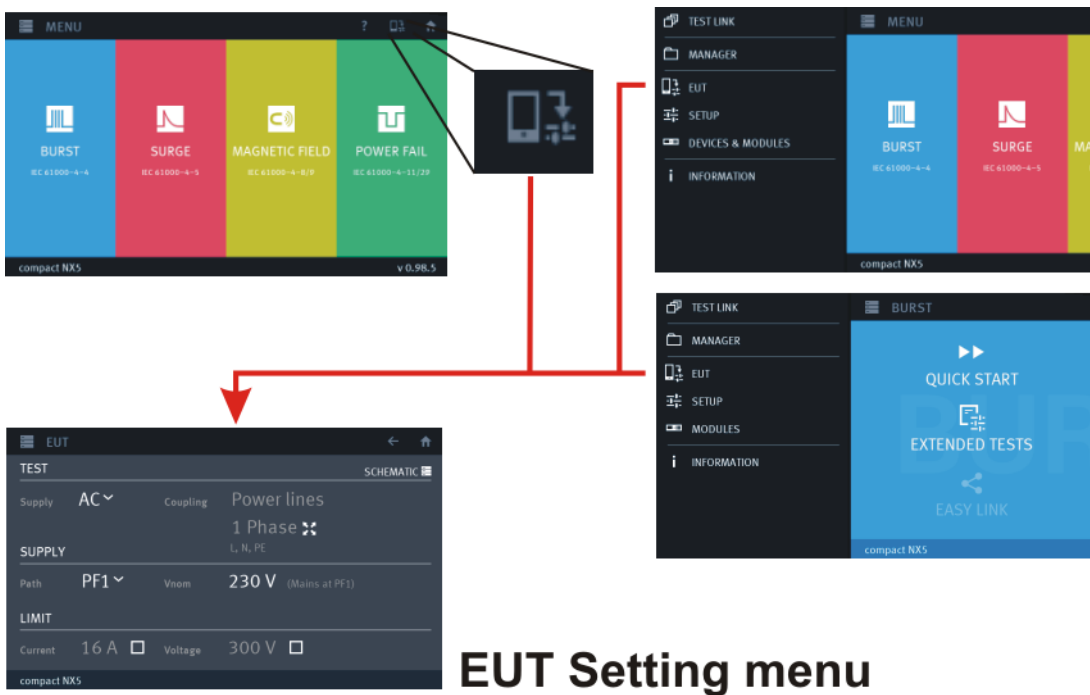

EUT Setting menu

EUT Setup

The generator uses the settings and offers exact the needed information for the EUT. All needless information will not be displayed

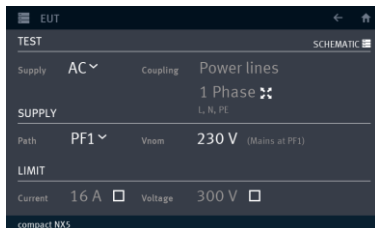

- ← EUT Configuration and Setup for the test.
- ← EUT and Supply path and mains voltage configuration
- ← EUT current and voltage limit

4.3.5.1. EUT Setup / TEST

TEST Power configuration for the actual connected EUT

Supply: AC
DC

Coupling: Power lines
Data lines



Phase Filter: Select the used lines
- 1-phase (L, N, PE)
- 3-phases (L1, L2, L3, N, PE)

1 Phase

3 Phase

Coupling Select the used coupling Mode to the selected coupling device
- 1 phase for NX5 device
- 1 or 3 Phase for coupling NX

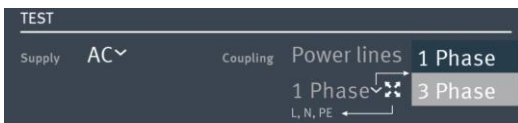

Supply **AC**

Coupling **Power Lines**

1 Phase

L, N, PE
L, N

with PE
no PE

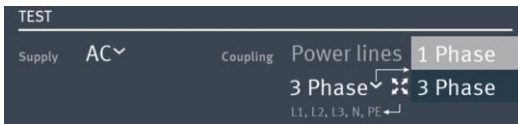

3 Phases

L1, L2, L3, N, PE
L1, L2, L3, N
L1, L2, L3, PE
L1, L2, L3
L1, L2, PE
Lx, Lx, ...

Star with PE
Star no PE (PEN)
Delta with PE
Delta np PE
Interphase
other combination



Supply **DC**

Coupling **Power Lines**

Plus, Minus, PE
Plus, Minus

with PE
no PE

4.3.5.2. EUT Setup / SUPPLY

SUPPLY Defines the default supply path to the EUT and the nominal voltage. For DC application the user needs two DC sources for PF1 and PF2 voltage each.

Path: PF1 Mains voltage from the power grid
PF2 Voltage from the variac or tapped transformer

Vnom: Mains voltage or defined voltage



Path

Vnom (mains from the grid)

PF1

100 V, 115 V, 230 V, or any mains voltage

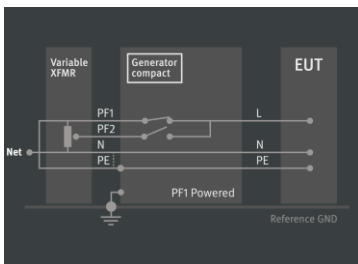

NOTE: PF1 is the default setting for general application for Burst, Surge and Power Fail testing.
The compact NX generator uses this *Vnom* voltage as **100% value for Dips** test as per IEC 61000-4-11.

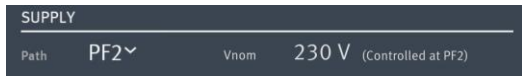

Path
PF2

Vnom (controlled at PF2)
Any voltage (example 230 V- 10%)
The variac voltage is set to the following voltages:

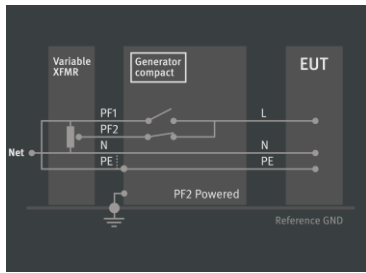

Power Fail: settled DIP voltage
Power magnetic Field: 0 V
All other phenomenon's: Vnom (PF2)

NOTE: PF2 is used for operate a EUT with different voltage than the actual mains voltage.
For Power Fail tests only PF2 mode with voltage interrupt tests are possible.

4.3.5.3. EUT Setup / LIMIT

LIMIT Defines the limit for the voltage and current rms measurement for stop the test.

- **Enable the box** for activate and set the limit
- Current limit will trip if the current is above the settled limit and will **break / stop the test**
- Voltage limit will trip if the rms voltage is above the settled limit and will **break / stop the test**

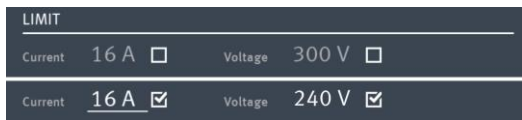
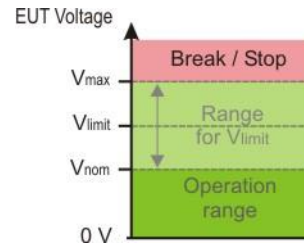
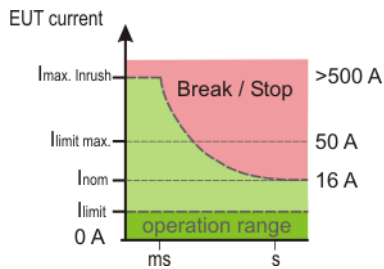

	Enabled (white)	Disabled (grey)
Current:	Range 0 to 50 A	no function
Voltage:	Range 0 to 300 V	no function

Internal hardware current limiter

The built in internal hardware limiter operates as follow. In case of an overcurrent the **TEST ON** is switched off, and the user has to confirm a message.

16 A models

$I < 23 \text{ A}$	No action
$23 \text{ A} \leq I < 40 \text{ A}$	Fail after 45 s
$40 \text{ A} \leq I < 50 \text{ A}$	Fail after 30 s
$50 \text{ A} \leq I$	Fail after 5 s

32 A models

$I < 46 \text{ A}$	No action
$46 \text{ A} \leq I < 80 \text{ A}$	Fail after 45 s
$80 \text{ A} \leq I < 100 \text{ A}$	Fail after 30 s
$100 \text{ A} \leq I$	Fail after 5 s

4.3.5.4. RMS Measurement

The built in RMS measurement measures the EUT voltage and current.

During the surge coupling an ac current is flowing over the coupling capacitor through the surge wave shape circuit. This current is also measured by the rms meter and is to respect for the EUT reading.

Additional ac current during surge coupling:

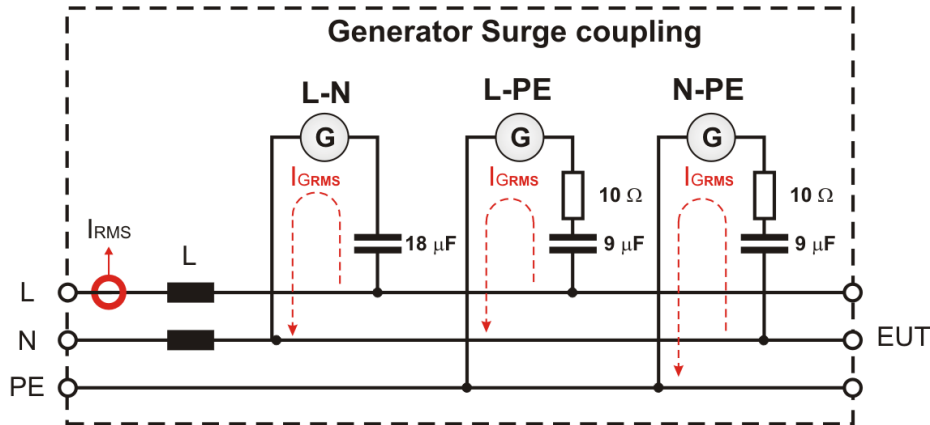

Current in the coupling path measured by the EUT current meter

Current I_{GRMS} through the coupling pat at 50 Hz

$U_{nom} / 50 \text{ Hz}$	Coupling L-N	Coupling L-PE
100 V	0.57 A	0.28 A
115 V	0.65 A	0.32 A
230 V	1.30 A	0.65 A

Current I_{GRMS} through the coupling pat at 60 Hz

$U_{nom} / 60 \text{ Hz}$	Coupling L-N	Coupling L-PE
100 V	0.68 A	0.34 A
115 V	0.78 A	0.39 A
230 V	1.56 A	0.78 A

4.3.6. Setup

The Setup menu is the place where the user configures his test equipment and device behavior.

General: Setup menu for the NX system

Equipment: Setup menu for equipment's connected to the NX test generator

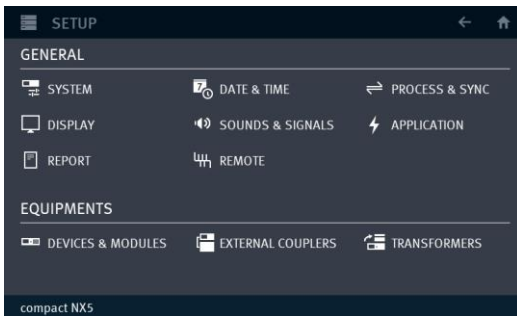

Overview Setup

General

System:	Language, Display design, Home screen, Last test memory
Date & Time:	Setting date and time with format,
Process & Sync:	Ac mains synchronization, timeout for sync and trigger, Power frequency detection, HV-COM 18 μ F capacitor
Display:	Brightness
Sounds & Signals:	Loudspeaker volume; Surge countdown; Trigger waiting; Test running; Test finish
Application:	Surge coupling to HV-COM output with 18 μ F enable
Report:	Report settings implemented from V 3.0.0 and higher
Remote:	IP address, subnet mask, gateway, MAC address

Equipment's

Devices and Modules	List of all available Devices and Modules like Burst, Surge, Telecom Surge, Power Fail, Magnetic Field, Ringwave...
External Couplers:	3-phase coupling networks, Magnetic field antennas
Transformers:	Variac transformers, tapped transformers, H-field ac transformers

4.3.6.1. Setup / General / System menu

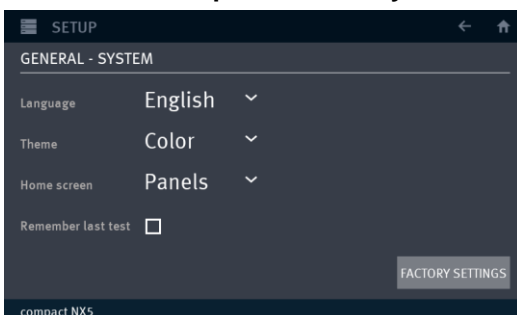

Language: Selection English (default), German, Italian, Polish, ...

Color: Color design of the display selection



Home screen: Design of the home screen



Remember last test:

Enable: When enter in any test menu; the software will automatically load the same test that was used last time in this menu.

Disabled: Load the selected test in the menu.

FACTORY SETTING

Sets all parameters to the factory settings, even the messages.

4.3.6.2. Setup / General / Date and Time menu

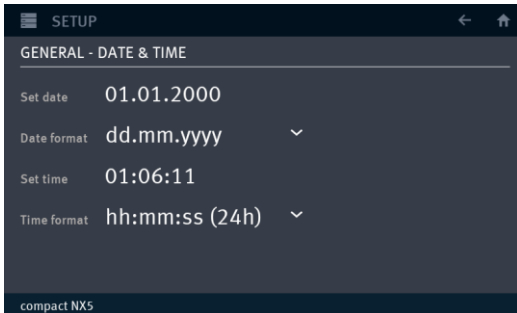

Set Date: Year; Month and Day from calendar
For set tap to the Year, Month (date)

Date format: dd.mm.yyyy; dd-mm-yyyy, dd/mm/yyyy, yyyy-mm-dd

Set time: Hour; minute

Time format: hh:mm:ss (24 h), hh:mm:ss (12 h)

4.3.6.3. Setup / General / Process & Sync menu

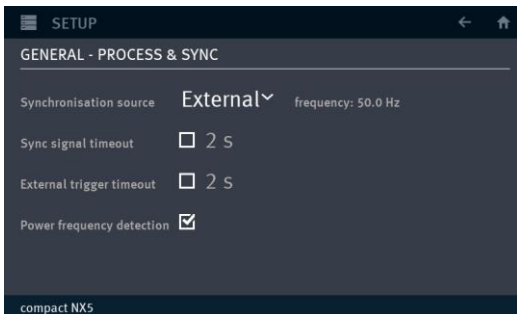

Synchronization: Phase angle sync form EUT line or from an external sync signal.

Internal: 1-phase: Phase L to N
3-phases: Phase L1 to N

External: Sync input rear: Low – High max. 690 V

Sync signal timeout: Waiting time to sync timeout

Disable: Default setting, no timeout

Enable: activate and set time [s]

External trigger timeout: Waiting time to external trigger timeout

Disable: Default setting, no timeout

Enable: activate and set time [s]

Power Frequency detection:

Disable: No filter for Power Fail standard

Enable: Standard library is filtered to 50 Hz / 60 Hz

4.3.6.4. Setup / General / Display

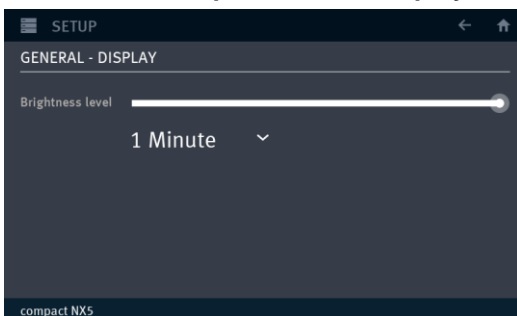

Brightness level:

Move the cursor to change

Timer Dims the backlighting after the preset time if no touch is carried.

Setting:

1, 2, 10, 20 minutes

1 hour

never

4.3.6.5. Setup / General / Sounds & Signals

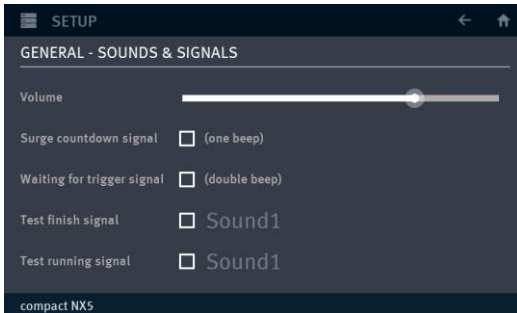

General sounds and signals level:

Volume: Move the cursor to change

Surge countdown signal: one beep signal

Disable: no beep signal

Enable: one beep signal approx. 1 s before trigger

Waiting for trigger signal: double beep signal

Disable: no beep signal

Enable: double beep signal when ready

Test finish signal:

Disable: no sound

Enable: selected sound is playing

Test running signal:

Disable: no sound

Enable: selected sound is playing during the test

Sound selection

For the running and test finished signal are 10 different sound signals available.

The user can individual selects one of these signals or load his own MP3 sound into the library. Max. file size= **10 MB**

Delete a sound

Delete the file with long-click and follow the procedure



Sound selection procedure:

1. Enable the sound button. The predefined sound-number is highlighted

2. Select the sound. The sound will start when selected

New from USB:

1. Insert USB stick on front
2. Select **<New from USB>**

4.3.6.6. Setup / General /Application

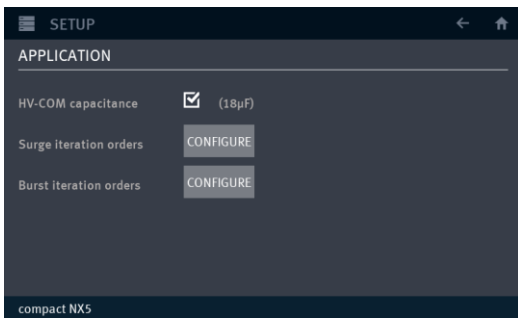

HV – COM capacitance: HV – COM output at rear side
Direct or coupled with 18 µF

Surge Iteration orders: Definition of parameter iteration

Burst Iteration orders: Definition of parameter orders

Advanced decimal: Number of digits for transformer factors

HV – COM capacitance: HV – COM output at rear side

Default setting is “Enable”. When using an EM Test coupling device, the capacitor is automatically disabled. The recognized connected EM TEST 3-phase CDN has already a built in 18 µF capacitor.

Enable: - Generator impedance 2 Ω + 18 µF coupling

Application:	- External CDN without 18 µF capacitors - Other application where 18 µF is required (pulsed H- field, surge verification at this output)	
--------------	---	--

Disable: - Generator impedance is 2 Ω

Application:	- External CDN with built in 18 µF capacitors - Verification of the HV-COM output	
--------------	--	--

Surge Iteration orders:

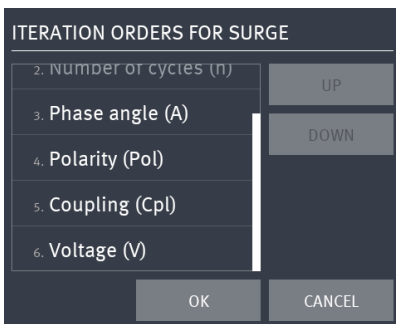

Parameter Iteration orders for surge test

Default: Phase Angle, Polarity, Coupling, Voltage

1. **Select** any **parameter** for change
2. Change order with **UP / DOWN**
3. Press **OK** or **Cancel**

Note: The parameter “Repetition time” and “Number of cycles (n pulses)” are fix parameters for the surge test and can’t be iterated.

Burst Iteration orders:

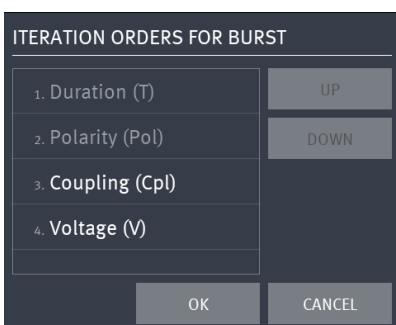

Parameter Iteration orders for burst test

Default: Coupling, Voltage

1. **Select** any **parameter** for change
2. Change order with **UP / DOWN**
3. Press **OK** or **Cancel**

Note: The parameter “Duration” and “Polarity” are fix parameters for the burst test and can’t be iterated.

4.3.6.7. Setup / General / Report

Report menu is implemented on version 3.0.0.0. and higher

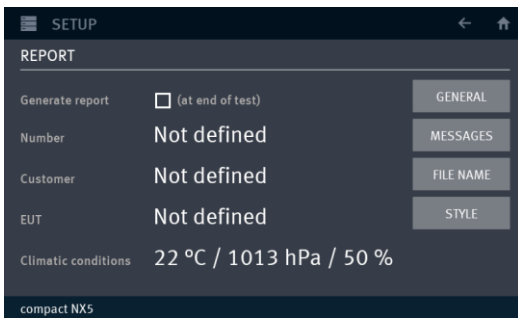

Individual setting for:

- Generator report
- Test report number
- Customer name
- EUT name General Report generation,

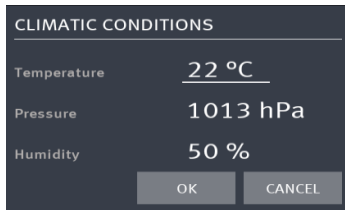

- Climatic condition of the EUT during test

Parameter	Input Range
- Temperature [°C, °F, °K]	- 30 °C - + 80 °C
- Pressure [h Pascal]	800 hPa – 1100 hPa
- Relative humidity [%]	0 % - 100 %

All settings work with Keypad only

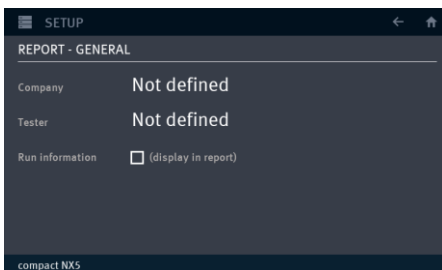

Report General

- Company Company Name
- Tester Name of the tester
- Run Information Shows the run information in the report. Additional actions like settings, Peak measurements etc..



Report Message

The user can predefine messages that are displayed and selectable during a pause.

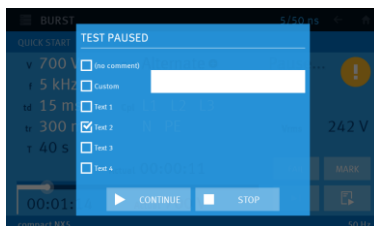

Report Break Messages

Example for the message box during a pause with four preselected messages. The selected message will be added to the report.

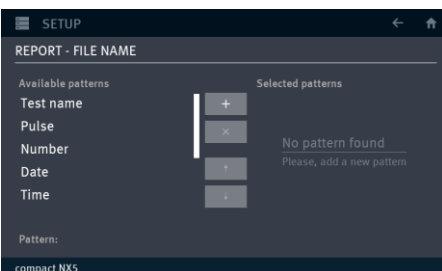

Report Filename

The user defines the report file name which is displayed as proposal after the test. The filename is built with the selected patterns

- + Add the selected pattern into the list
- Removes the selected pattern from the list
- ↑ ↓ Shift the selected symbol in the list

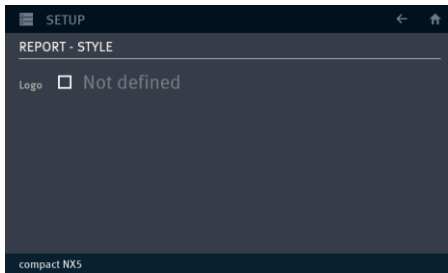

Report Style

The user can load a logo that will be implemented in the report.

Supported Formats: png, jpg

Max. file size: 200 kBytes

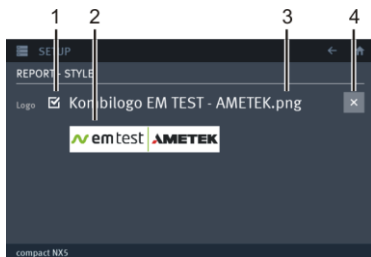

Report Style (loaded logo)

- 1 Indication for implement the picture in the report
- 2 Picture in reduced resolution
- 3 Filename
- 4 Deletes the actual loaded picture

4.3.6.8. Setup / General / Remote

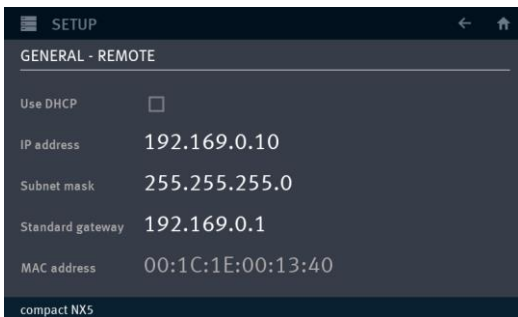

Use DHCP:

Default setting for automatic address detection and setting is disabled

Individual setting for:

- IP Address
- Subnet Mask
- Standard Gateway

MAC Address:

Device MAC address

4.3.6.9. Setup / Equipment / Devices & Modules

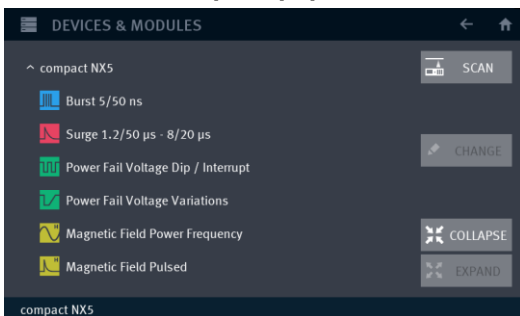

The Device & Modules screen shows all recognized modules in the present system.

System equipment's are displayed with his internal modules. A "longpress" to compact NX5 will show the **serial number** and **software number** of the compact NX generator.

4.3.6.10. Setup / Equipment / External Couplers

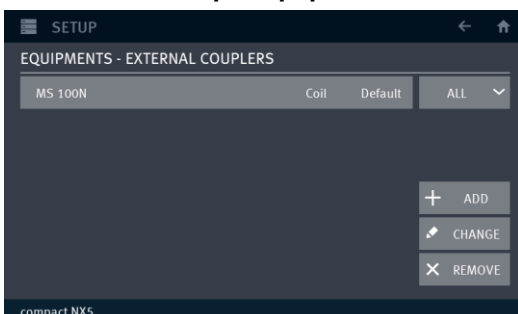

Define and load an external coupler

Coil Magnetic field coil

4.3.6.11. Setup / Equipment / Transformers

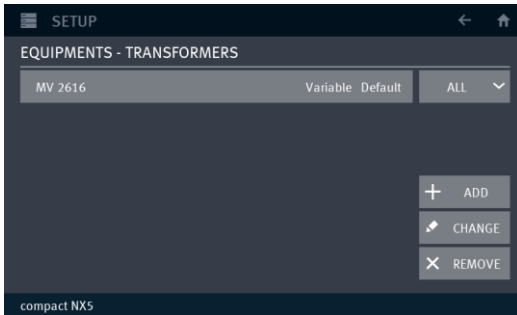

Define and load an external transformer

Variable Motorized variac transformer

Tapped Tapped transformer

H-Field Magnetic field current transformer

Default transformer Library

Variable Transformer:

- variac NX1-260-16
- variac NX1-260-32

Tapped Transformer:

- V 4780
- V 4780 S2
- V 4780 S3

H-Field Transformer

- MC 26100
- MC 2630 (30 A range)
- MC 2630 (3 A range)

4.3.7. TEST Link

TEST LINK



In this menu the user creates and complete his own “Test Link”

A “Test Link” is generated from

- Test files, loaded from the library (Burst, Surge...)
- Pause or messages with information to the test
- Save or load any test

4.3.8. Manager

Manager



The user configures in this menu the library Manager of all existed test files.

- Rename of tests (Standards & User)
- Mark as visible or hide (Standards & User)
- Remove test from the library (User)
- Import and Export of test (All change to User test)

4.3.9. Devices & Modules

Devices & Modules

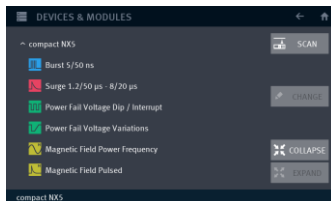

Module screen shows all recognized modules in the present system.

System equipment's are displayed with his internal modules. The user can

4.3.9.1. Select the output path where to couple the impulse

To define at which device the generated pulse to applies, the user must configure it in the system. This happens in the **menu Devices and Modules**



Internal Pulse output at the compact NX5 CDN
- 1 phase

External Pulse output at the coupling NX5...CDN
- 1 phase
- 3 phase

Software Update procedure

1. Select **MENU /**
2. Select **DEVICES & MODULES**

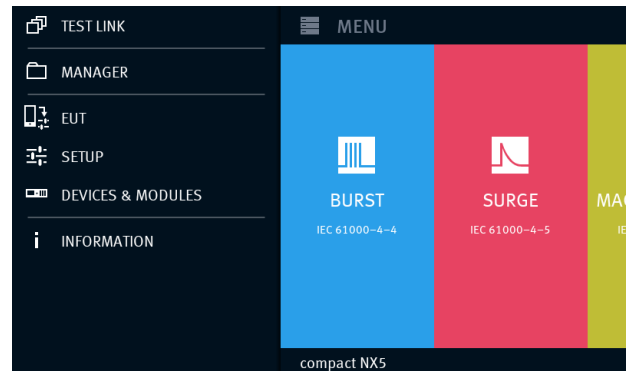

3. Make a **long click** to compact NX5

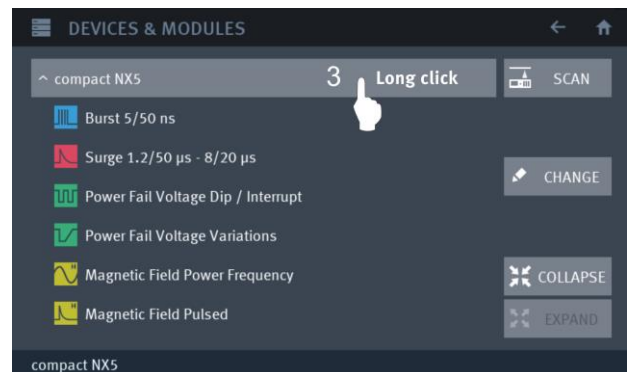

4. Select the coupling device for testing:
 - **INTERNAL**
using CDN from compact NX5 generator
 - **EXTERNAL**
using CDN from coupling NX5

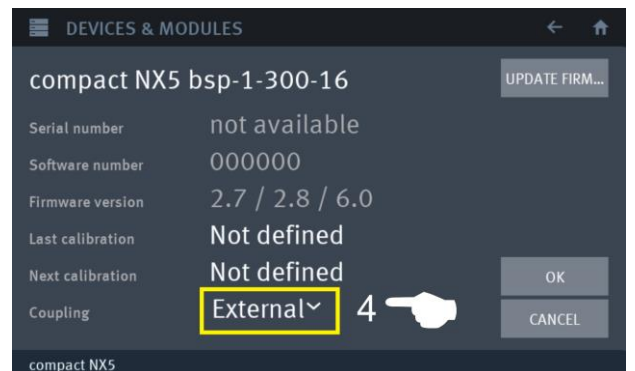

4.3.10. Information

Information



System Information

- Device Version, Firmware, Software
- Representative address EM TEST / AMETEK CTS offices, when touch the national flags
- CH, Germany, USA, Poland, France, Italy, Austria, China, Japan
- Software update menu (see chapter software update) **3.6. Software Update**
Press “**Update Software**” button for return when detecting update

4.4. Service

The addresses of the EM TEST (Switzerland) GmbH and the EM TEST locations are shown.

The addresses of all EM TEST sales agencies are listed on the web site of EM Test under :

www.emtest.com

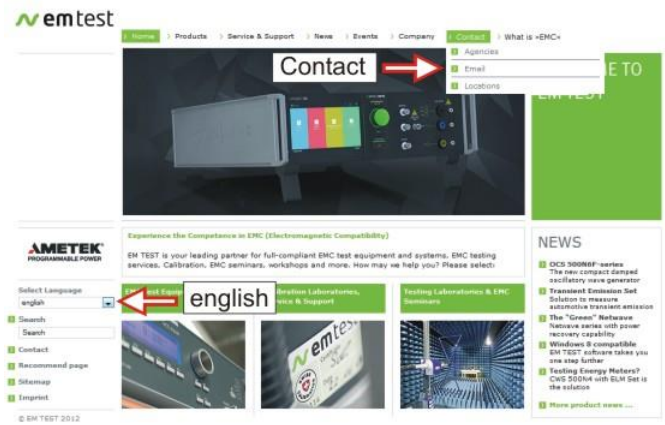

4.5. Variable voltage transformers adjustment procedure

The compact NX5 is able to control an external voltage source with a 0-10V analogue dc signal. The 10V level corresponds to the max. output voltage of the connected voltage source. For the correct setting it is necessary to know the max. output voltage of the source. For setting for ac or dc source the same procedure is necessary.

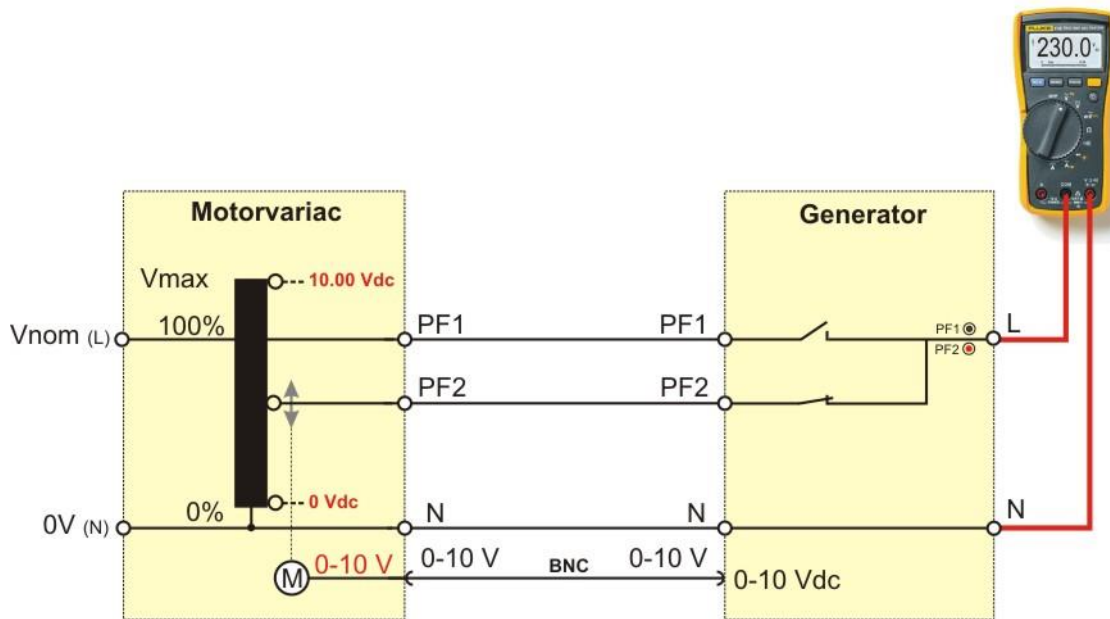

Setup for adjust the external voltage variac to the compact NX5

The voltage setting is a regulating procedure where one winding of the motor-variatic is approx. 1.9 V. Additionally the control needs some mechanical tolerance for stop the step motor. Therefore the selected voltage is normally in a tolerance of ± 4 V. The motor-variatic control has an internal dead-zone where the voltage will not be adjusted.

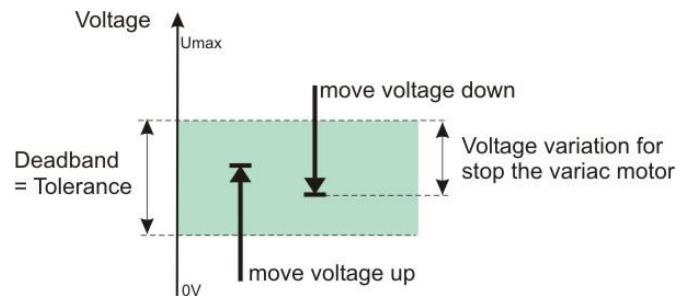

The following procedure will guide the user through the Set Voltage procedure. The setting procedure for Vmax and Vnom is listed in the figures below.

If the output voltage is out of the tolerance, change the Vmax voltage and repeat the procedure.

4.5.1. Adjustment procedure for variable transformers

For adjust a variac transformer, select first the device to adjust in: **Menu / Setup / Transformers / Variable**

1. Select **CHANGE** or make a **Long click** into the device for change into the software setup. *This will rotate the screen and opens the configuration parameter of the device.*

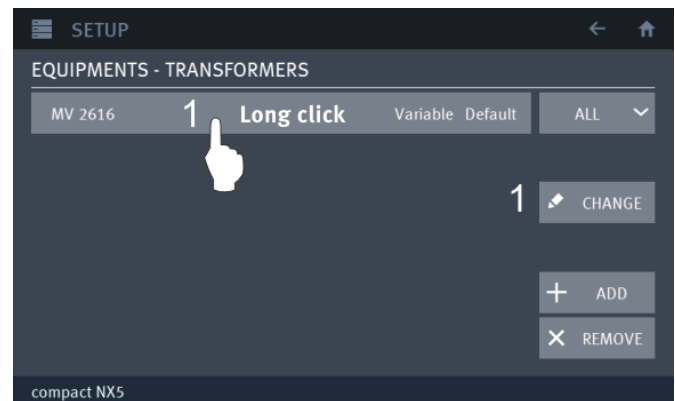

Adjustment procedure

The adjustment procedure has the following structure:

2. Press **ADJUSTMENT** for start the adjustment procedure.

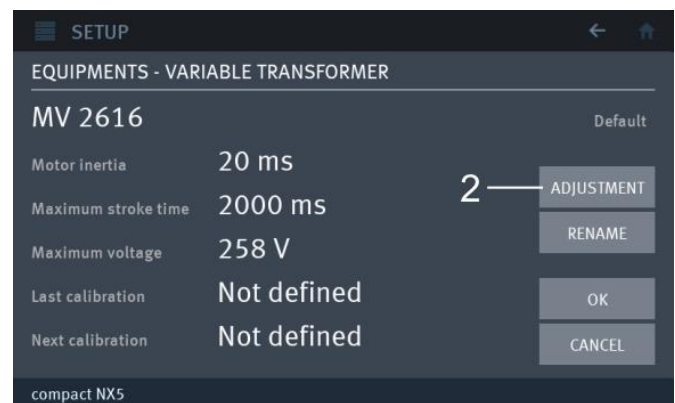

Initialize the adjustment wizard

For prepare

- Press **TEST ON** (if not activated)
- Connect variable transformer at the rear side to the generator to plug PF1, PF2, N, PE
- Connect a multimeter to the front side connectors "Test supply" output L and N

3. Press **Next** to continue or **Cancel** for exit.

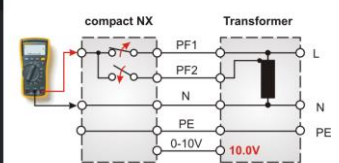

Detect the max. variac output voltage

- Settled nominal voltage: to max. voltage
- Output (0-10 V) voltage: 10.00 V

4. **Read the value** at the voltmeter and
5. Enter the value to **Maximum voltage** field
6. Press **NEXT** to continue

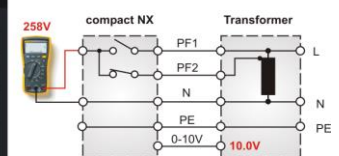

Check at V_{nom} (230 V) level. variac output voltage

- Settled nominal voltage: =V_{nom} (230 V)
- Output (0-10 V) voltage: 230V/Max. voltage *10.00 V

7. **Read the value** at the voltmeter and check if the value is inside the tolerance of ± 4 V
8. If needed correct the **Maximum voltage**
 - **decrease** the value for higher voltage
 - **increase** the value for lower output
9. Press **NEXT** to continue

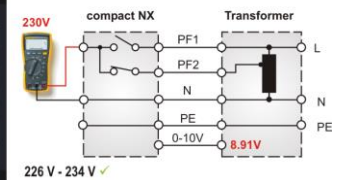
**Check at V_{nom} (100 V) level. variac output voltage**

- Settled nominal voltage: = V_{nom} (100 V)
- Output (0-10 V) voltage: 100V/Max. voltage *10.00 V

10. **Read the value** at the voltmeter and check if the value is inside the tolerance of ± 4 V
11. If needed correct the **Maximum voltage**
 - **decrease** the value for higher voltage
 - **increase** the value for lower output
12. Press **NEXT** to continue

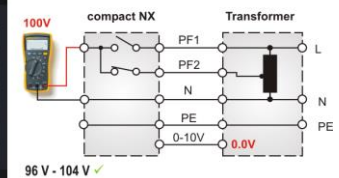
**Check at V_{nom} (0 V) level at zero position**

- Settled nominal voltage: = V_{nom} (0 V)
- Output (0-10 V) voltage: 0 V to 0.3 V

13. **Read the value** at the voltmeter and check if the value is below 8 V
14. If needed correct the **Maximum voltage**
 - **decrease** the value for higher voltage
 - **increase** the value for lower output

NOTE: The correction at this level will change the voltage only marginal. Note that one transformer winding is approx. 1.9 V
15. Press **NEXT** to continue

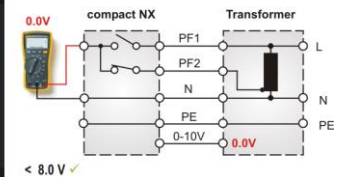
**Check at V_{nom} (230 V) level. variac output voltage**

- Settled nominal voltage: =V_{nom} (230 V)
- Output (0-10 V) voltage: 230V/Max. voltage *10.00 V

16. **Read the value** at the voltmeter and check if the value is inside the tolerance of ± 4 V
17. If needed correct the **Maximum voltage**
 - **decrease** the value for higher voltage
 - **increase** the value for lower output
18. Press **NEXT** to continue

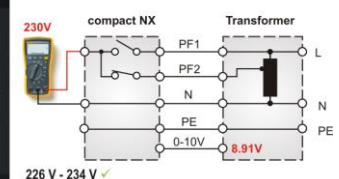
**Final screen of max. voltage adjustment**

- Settled nominal voltage: =V_{nom} (230 V)
- Output (0-10 V) voltage: 230V/Max. voltage *10.00 V

19. **OK:** Write the max. Voltage value into the parameter list and exit wizard.

Previous: Jumpers to the previous page

Cancel: Exit the wizard without change

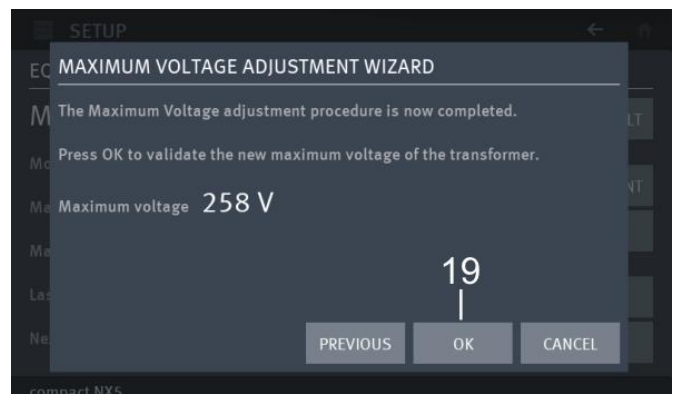

4.5.2. Adjustment procedure for tapped transformers with analogue DC control voltage

For adjust a tapped transformer, select first the device to adjust in: **Menu / Setup / Transformers / Variable**

The tapped transformer is programmed that the **nominal voltage** corresponds to **10.0V dc** as **100%** for set. The settings are defined as following:

Position	ref dc voltage
80%	8.00 V \pm 0.35V
70%	7.00 V \pm 0.35V
40%	4.00 V \pm 0.35V

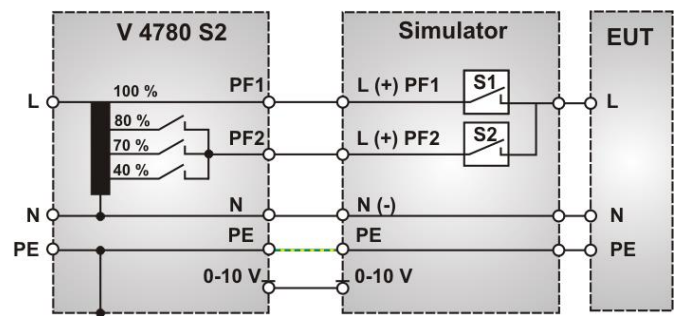

Example for automatic tapped transformer V 4780 S2

1. Make a **click**, **Long click** into the device or press **CHANGE** button for change into the software setup.
This will rotate the screen and opens the configuration parameter of the device.

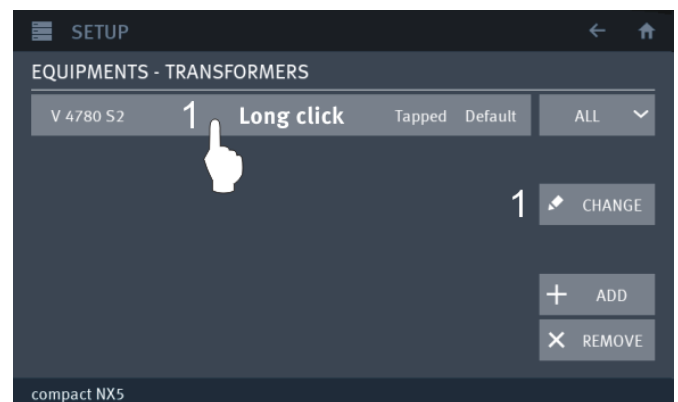

Adjustment procedure

The 100% value of the tapped transformer must correspond to the actual nominal voltage of the EUT.

3. Press **230 V** for adjust the 100% voltage
4. Enter the nominal EUT voltage used for the test (**100 V, 115 V, 220 V or 230 V**) and confirm with **OK**.
5. Confirm and exit with **OK**

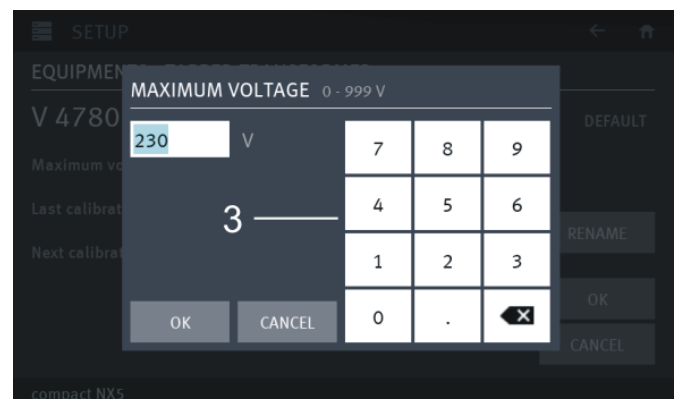
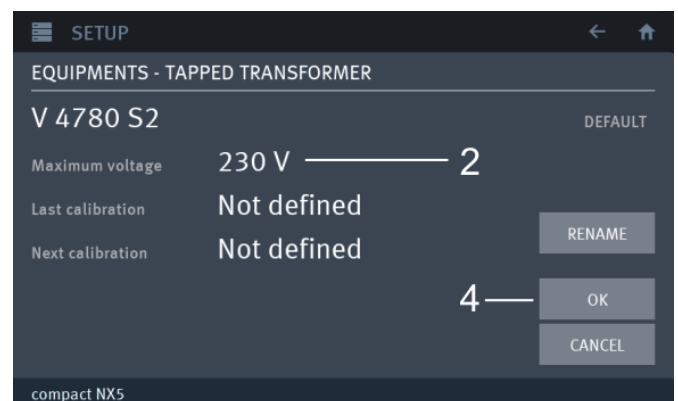

5. Test Equipment compact NX5 N

The simulator compact NX5 N is separated in different main parts. The control unit is screened to all other parts.

5.1. compact NX5

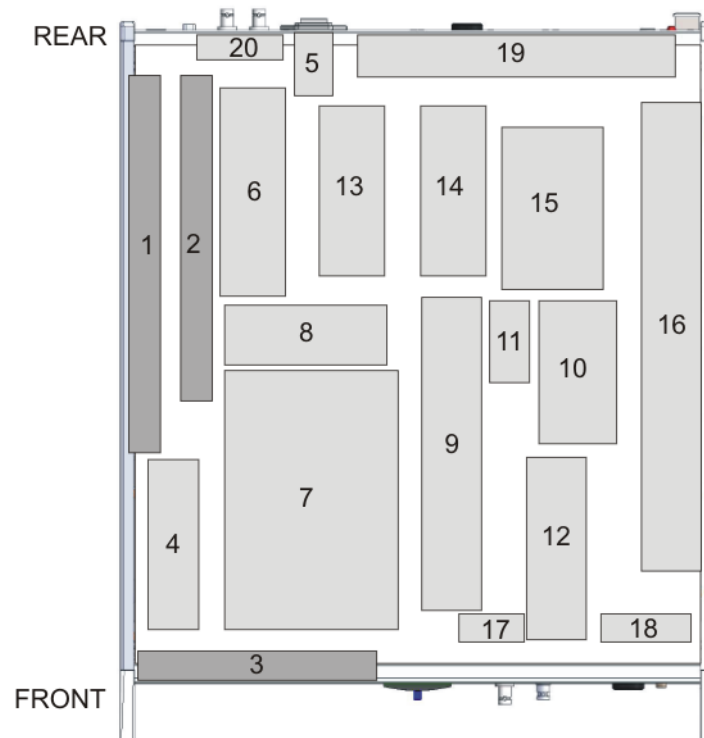

Control unit

- 1 App board controller
- 2 Device board controller
- 3 HMI board, touch panel

Power supply

- 4 Power supply
- 5 Mains filter

High voltage unit

- 6 High voltage power supply
- 7 Energy storage capacitor, Pulse forming
- 8 Measuring Unit
- 9 Surge pulse forming unit
- 10 Surge coupling capacitor
- 11 Surge pulse measuring transformer
- 12 Burst pulse forming unit
- 13 Power Fail switch PF2
- 14 Power Fail switch PF1

- 15 decoupling inductors 1.5 mH
- 15 Measuring unit
- 16 Coupling relays surge
- 17 Peak current measurement
- 18 Burst Coupling board
- 19 Back filter board
- 20 Rear panel interface board

6. Technical data

6.1. EFT Electrical Fast Transients Burst as per IEC 61000-4-4

Test Level	Model N5		
Open circuit *	200 V – 5500 V ± 10% Step 1 V		
Wave shape into a 50Ω load	100 V – 2750 V		
Rise time tr	5 ns ± 30%		
Pulse duration td	50 ns ± 30%		
Wave shape into a 1000Ω load	200 V – 5500 V		
Rise time tr	5 ns ± 30%		
Pulse duration td	35 ns – 150 ns		
Source impedance	Zq = 50 Ω ± 20%		
Polarity	Positive / negative		
Trigger			
Trigger of bursts	AUTO, MANUAL, EXTERN		
Synchronization	0 - 360° (16 – 500 Hz)		
	Asynchronous = 0°	a reference signal is connected to the Sync input.	
Burst duration td	0.10 ms – 999 ms		
Burst repetition rate tr	10 ms – 9999 ms		
Spike frequency f	1Hz – 1000 kHz	Range	Step
		< 10 kHz	1 Hz
		10 – 1000 kHz	1.0 kHz
Test duration T	1 s – 9999 s		
	1 min - 167 min		
Output			
Direct via 50 Ω coaxial connector	To connect ext. coupling devices		
Coupling network	To L, N, PE all combinations		
EUT power mains supply	AC 300 V / 16 A / 50/60 Hz		
	DC 300 V / 160 A		
Test routines			
Quick Start	Immediate start, all parameters adjustable during a running test		
Standard test as per separated to (AC / DC)	IEC 61000-4-4 level 1-4 to power lines IEC 61000-4-4 level 1-4 to signal lines EN 61000-6-1 Generic to power lines EN 61000-6-1 Generic to signal lines EN 61000-6-2 Generic to power lines EN 61000-6-2 Generic to signal lines IEC 61000- 4-4 Manual operated standard test routine		
Extended Tests	Voltage iteration stepwise: Voltage level V after n pulses by ΔV Frequency sweep in one single burst Frequency sweep with constant pulse numbers Frequency sweep, constant burst duration Synchronized with phase angle Random burst release		

* With Burst pulses as per. IEC 61000-4-4 Ed 3: 2012 the max. output voltage with external CDN can be limited.

6.2. SURGE Immunity requirements as per IEC 61000-4-5

Test Level	compact NX5 (16A Models)		compact NX5 (32 A Models)		
	Open circuit voltage	160 V – 5000 V ± 10% Step 1 V			
Short circuit current	80 A – 2500 A ± 10%				
Wave shape open circuit					
coupling	18 µF line to line	9 µF line to ground	18 µF line to line	9 µF line to ground	
Front time tr	1,2 µs ± 30%	1,2 µs ± 30%	1,2 µs ± 30%	1,2 µs ± 30%	
Pulse duration	50 µs +10 µs/-10 µs	50 µs +10 µs/-25 µs	50 µs +10 µs/-15 µs	50 µs +10 µs/-30 µs	
Wave shape short circuit					
coupling	18 µF line to line	9 µF line to ground			
Front time tr	8 µs ± 20%	2.5 µs ± 30%			
Pulse duration	20 µs ± 20%	25 µs ± 30%			
Polarity	Pos., Neg., Alt				
Repetition rate	max. 1 Hz (1 s* - 9999 s)				
Events preselection	1 - 99'999				
Counter	1 – 1'000'000				
Trigger					
Trigger of pulses	AUTO, MAN, EXTERN				
Synchronization	0 - 360° (16 – 500 Hz)				
Resolution	Asynchronous = 0°		a reference signal is connected to the Sync input.		
	1°		1°		
Measurements					
CRO	5 V Trigger				
CRO Ũ	10 Vp at 5 kV				
CRO Î	10 Vp at 2.5 kA				
Accuracy CRO V , CRO I	± 10%				
CRO Ũ/I Z measuring instrument	> 1 MΩ				
Peak voltmeter	5000 V				
Peak current meter	2500 A: Display ± 1 Digit ± 20 A				
Current limiter setting	10 A...3000 A step 10 A				
Output			no	9 µF	18 µF
Direct HV-COM	HV-Banana connector, Zi = 2Ω		x		x
Coupling network	L – N with Z = 2Ω				x
	L-PE, N-PE, L+N-PE with Z = 12Ω			x	
DUT supply	AC 300 V / 16 A / 50/60 Hz				
	DC 300 V / 16 A				
Test Routines					
Quick Start	Immediate start, all parameters adjustable during a running test				
Standard test routines <i>separated to (AC / DC)</i>	IEC 61000-4-5 one level: Selectable level 1 to 4 IEC 61000-4-5 all levels: Starts from lowest level to selected level IEC 61000-4-5 level 3 IEC 61000-4-5 level 4 EN 61000-6-1 Generic (AC / DC) EN 61000-6-2 Generic				
Extended Tests	Voltage iteration stepwise: Voltage level V after n pulses by ΔV Angle iteration stepwise: Change phase angle A after n pulses by ΔA Angle random iteration: Random phase angle A after n pulses				

* depends on charging voltage

6.3. Pulsed magnetic Field as per IEC 61000-4-9

Test Level	Model NX5			
Generator charging voltage	160 V – 5000 V \pm 10% Step 1 V			
Short circuit current	80 A – 2500 A \pm 10%			Approx. 80 A/m to 2500 A/m
Wave shape				
Rise time tr	8 μ s \pm 20%			
Pulse duration	20 μ s \pm 20%			
Polarity	Pos., Neg., Alt			
Repetition rate	max. 1 Hz (1 s* - 999 s)			
Events preselection	1 - 99'999			
Counter	1 – 1'000'000			
Trigger				
Trigger of pulses	AUTO, MAN, EXTERN			
Synchronization	0 - 360° (16 – 500 Hz)			
Resolution	Asynchronous = 0°	a reference signal is connected to the Sync input.		
	1°		1°	
Measurements				
CRO	5 V Trigger			
CRO V	10 Vp at 5 kV			
CRO I	10 Vp at 2.5 kA			
Accuracy CRO V CRO I	\pm 10%			
CRO V/I Z measuring instrument	> 1 M Ω			
Peak voltmeter	5000 V			
Peak current meter	2500 A: Display \pm 1 Digit \pm 20 A			
Current limiter setting	10 A...3000 A step 10 A			
Output				
Direct HV-COM	HV-Banana connector, Zi = 2 Ω	no	9 μ F	18 μ F
Coupling network	L – N with Z = 2 Ω	x		x
	L-PE, N-PE, L+N-PE with Z = 12 Ω		x	x
DUT supply	AC 300 V / 16 A / 50/60 Hz DC 300 V / 16 A			
Test Routines				
Quick Start	Immediate start, all parameters adjustable during a running test			
Standard test routines <i>separated to (AC / DC)</i>	IEC 61000-4-5 one level: Selectable level 1 to 4 IEC 61000-4-5 all levels: Starts from lowest level to selected level IEC 61000-4-5 level 3 IEC 61000-4-5 level 4 EN 61000-6-1 Generic (AC / DC) EN 61000-6-2 Generic			
Extended Tests	Voltage iteration stepwise: Voltage level V after n pulses by Δ V Angle iteration stepwise: Change phase angle A after n pulses by Δ A Angle random iteration: Random phase angle A after n pulses			
Magnetic field test	test routine as per IEC 61000-4-9 test level 100, 300 and 1000 A/m cont. adjustable within Quick Start			

* depends on charging voltage

6.4. Power Fail Generator as per IEC 61000-4-11

EUT supply	Model NX5	Other models NX series
Channel PF1 and PF2		
AC voltage/current	max. 300V/16 A	Up to max. 400 V/ 32 A
Mains frequency	50/60 Hz	
DC voltage/current	max. 300 V/16 A	Up to max. 300 V/32 A
Inrush current	more than 500 A	
Protection	Electronic fuse for continuous overcurrent / inrush currents Electronic control of overheating PF1 and PF2 are safe against short circuit	
max. current channel PF1	nominal current continuous	
max. current channel PF2	nominal current continuous	
Trigger		
Events trigger	AUTO, MAN, EXTERN	
Repetition rate	0.01s – 9'999 s	Accuracy 0.05% + phase sync
Duration of events	0.01 ms – 9'999 s	Accuracy 0.05%
Events preselection	1 - 99'999	
Counter	1 – 1'000'000	
Synchronization	0 - 360° (16 – 500 Hz) Asynchronous = 0° if a reference signal is connected to the Sync input.	
Max Sync input voltage	Max. 300 V or same as EUT voltage specs.	
Resolution	1°	
Measurements		
DUT supply	AC/DC voltage in the LCD display, divider ratio 1:100 +/- 10%	
BNC output MON U	Measurement of the EUT supply divider ratio 1:100 ± 5%	
BNC output MON I	Measurement of the EUT current and the inrush current 10 mV/A ± 5%, max. 1000 A	
CRO TRIGGER	positive going flank	
0-10V Control Output	0-10 Vdc for external voltage source	
Test routines		
Quick Start	Immediate start, all parameters adjustable during a running test	
Standard test routines	as per IEC 61000-4-11 ac power ports as per IEC 61000-4-29 dc power ports as per IEC 61000-6-1 Generic as per IEC 61000-6-2 Generic Manual operated standard test routine	
User test routines	Voltage variation, external variac control Change phase angle A after n events by ΔA Change events duration td after n events by Δtd Inverse mode	
Magnetic field test	test routine according to IEC 61000-4-8 test level 1, 3, 10 and 30 A/m with MC 2630 and a variac test level 100, 300 and 1000 A/m with MC26100	

Magnetic field tests per IEC 61000-4-8 and -9

The test routines for handling the magnetic field tests are included in the internal compact NX5 firmware. All functions to control external options as voltage/current sources or magnetic field antennas are included. In addition, the following hardware is required:

Option required for Magnetic Field Test per IEC 61000-4-9

- Magnetic field antenna (square 1mx1m coil MS 100)
- Adapter for connecting the square coil to the surge output.

Option required for Magnetic Field Test 50/60Hz per IEC 61000-4-8

- External transformer (variac NX1-260-16) and magnetic field antenna (square 1mx1m coil MS 100)
- External current transformer (MC2630) to test 1, 3, 10 and 30 A/m levels
- External current transformer (MC26100) to test level 100, 300 and 1000 A/m levels (short term).

6.5. EUT Supply Specifications

Standard models

Model	CDN		Remarks
compact NX5	300V	16A 1- phase	DC 300 V / 16 A



EUT Fuse

The compact NX5 models have **no internal fuse for the EUT** supply.
The user is responsible to adapt a suitable fuse for the EUT outside the compact NX5

6.6. General Specifications

Mains supply	85 to 264 Vac, 50/60Hz
Power consumption	75 W
Fuse	2 x 2 AT slow blow
Safety	
Safety circuit	External interlock capability
Warning lamp	voltage free contact max. 60 V 2 A
Design	As per IEC 1010, EN 61010
Interfaces	
Serial interface	1 x USB A front side for memory stick 1 x USB A rear side 1 x USB B 1x opto-link
LAN	Ethernet
SYS link IN, OUT	26 pin high density Sub D to control external devices
Analog output	0-10V DC, to control an external power supply
EUT1, EUT 2 input	
Digital input	+ 15 V to 0 V, negative slope to zero
Trigger level	2 V \pm 1 V
Input impedance	> 10 k Ω
Max. Input voltage	+ 15 V
Dimensions	
Weight	compact NX5 19" / 3 HU app. 25 kg

6.7. Environmental conditions

Temperature	10 °C to 35 °C
Humidity	30 % to 70 %; non condensing
Atmospheric pressure	86 kPa (860 mbar) to 106 kPa (1 060 mbar)

=> Not relevant data for the standards can be changed by the manufacturer <=

7. Maintenance setup and service

7.1. General

Inside the test system there are no adjustable elements accessible to the user neither for calibration nor for maintenance purpose.

The housing of the test system must not be opened. Should any maintenance or adjustment become necessary, the whole test system, together with an order or fault report, should be sent to an AMETEK CTS service center.

7.2. Maintenance and cleaning

The generator is absolutely maintenance-free by using a solid state semiconductor switch to generate transients. Maintenance by the user is restricted to cleaning the outer housing, performing a function check and verification of the pulse parameters.

In general, a moist cloth is sufficient for cleaning the outer housing, including the touch panel. If necessary add a small amount of a mild, non-foaming household cleanser.

No chemicals (acid, etc.) should be used for cleaning purposes.

Before beginning to clean the test system ensure that it is switched off and the mains power cable is unplugged from the supply.

7.3. Test set- up

When setting up the test national and international regulations regarding human safety have to be guaranteed.

It is recommended to connect the simulator to the ground reference plane of the test set-up.

The generators of the compact NX series and their coupling networks, can be linked together to a fully automotive test set-up.

The set-up communicates via the Ethernet / optical link is controlled by software. For setting up the system see the following figures:

7.4. Insulating- or external transformer for EUT power supply



The recommended power of an external transformer must be **> 500VA**. The reason is the capacitive current of the internal filter capacitors inside the compact NX5.

7.5. Calibration and verification

7.5.1. Factory calibration

Every EM TEST generator is entirely checked and calibrated as per international standard regulations before delivery. A calibration certificate is issued and delivered along with a list of the equipment used for the calibration proving the traceability of the measuring equipment. All auxiliary equipment and accessories are checked to our internal manufacturer guidelines.

The calibration certificate and the certificate of compliance (if available) show the date of calibration.

The EM Test equipment are calibrated in the factory and marked with a calibration mark. The used measuring instruments are traceable to the “Swiss Federal Office of Metrology”.

The calibration date is marked. The validity of the calibration is to the responsibility of the user’s quality system. Neither the certificate of calibration nor the corresponding label mark any due date for re-calibration.



Example: Calibration mark

7.5.2. Guideline to determine the calibration period of EM Test instrumentation

Our International Service Departments and our QA Manager are frequently asked about the calibration interval of EM TEST equipment.

EM TEST doesn’t know each customer’s Quality Assurance Policy nor do we know how often the equipment is used and what kind of tests are performed during the life cycle of a test equipment. Only the customer knows all the details and therefore the customer needs to specify the calibration interval for his test equipment.

In reply to all these questions we like to approach this issue as follows:

EM TEST make use of a solid state semiconductor switch technique to generate high voltage transients. A precious advantage of this technique is the absolute lack of periodical maintenance effort. In consequence thereof a useful calibration period has to be defined based on two criteria:

- The first one is the customer’s Quality Assurance Policy. Any existent internal regulation has to be applied at highest priority. In the absence of such internal regulation the utilization rate of the test equipment has to be taken into consideration.
- Based on the experience and observation collected over the years **EM TEST recommend a calibration interval of 1 year** for frequently used equipment. A 2-years calibration interval is considered sufficient for rarely used test generators in order to assure proper performance and compliance to the standard specifications.

7.5.3. Calibration of Accessories made by passive components only:

Passive components do not change their technical specification during storage. Therefore the measured values and the plots stay valid throughout the storage time. The date of shipment shall be considered as the date of calibration.

7.5.4. Periodically In-house verification

Please refer to the corresponding standard before carrying out a calibration or verification. The standard describes the procedure, the tolerances and the necessary auxiliary means. Suitable calibration adapters are needed. To compare the verification results, EM Test suggests to refer to the wave-shape and values of the original calibration certificate.

All calibrations and verifications are always done without mains supply voltage connected to the coupling network input.



Danger

Before starting the calibration or verification
remove the EUT Mains Supply
from the generator and from the coupling network

8. Delivery Groups

8.1. Basic equipment

- Generator model: compact NX5 with recommended modules (Burst, Surge, Power Fail, Magnetic Field, Telecom Surge)
- Mains cable
- Mains cable for the EUT supply
- Adapter for power cable
- Manual
- Calibration certificate

8.2. Accessories and options

- **ESA Adapter for adapt different power mains connectors**

As accessories adapters to different power mains connectors are part of the delivery of EM TEST surge generators. E.g. these are adaptors for Schuko - US - AUS - UK power mains connectors.

Most of these commercially available power mains sockets cannot withstand surge voltages higher than 4000V. Therefore each of these EM TEST adaptors are labeled to be **used up to 4000V** maximum.

In case that the EM TEST surge generator can generate higher surge voltages than 4000V a sparkover at the power mains socket may occur.

Customers shall be aware of this matter and shall **not use higher voltages than labeled** on the adapter.

For **testing higher voltage** it is necessary to use high voltage cables with sufficient isolation and safety banana connectors connected direct to the generator output plugs (L-N-PE).



Burst

- **PVF BKIT 1** Calibration kit for Burst verification on EUT output including PVF 50 + PVF 1000 and PVF AD1 adapter
- **PVF AD1** adapter for calibration
- **PVF 50** Matching resistor 50 Ω with integrated attenuator (1:100)
- **PVF 1000** Matching resistor 1000 Ω with integrated attenuator (1:500)
- **ICC** Industrial capacitive coupling clamp as per IEC 61000-4-4 to couple the fast transients to signal and data lines.
- **CCI PVKIT 1** Calibration kit for capacitive coupling clamp as per IEC 61000-4-4 Ed.3
 - Flexible plate insulated
 - Support for PVF 50 and adapter to PVF 50
- ITP EF Radiating set for immunity and emission
- **A6dB** as additional 6 dB / 50 Ω attenuator of the test signal
- **PUW 500** EUT monitoring



Surge

Power Fail

- **V4780 transformer with taps**
 - Transformer with taps at 40%, 70%, 80%
 - 230V / 16A
- **Variac NX-1-260-16**
 - Motorvariatic 0-260 V / 16 A or 32 A
 - Control signal 0-10 Vdc.



Magnetic field

MS 100N Magnetic field antenna

- **MC 2630** Current transformer up to 30 A/m
- **MC 26100** Current transformer up to 1000 A/m



MC 2630



MC 26100

General for Burst and Surge

- **Coupling NX5 bs-3-480-16 external coupling/decoupling network**
 - EUT mains supply 480 V rms max
 - Nominal current $I_n = 16 \text{ A} / 32\text{A} / 63\text{A} / 100 \text{ A rms}$
 - Frequency 50/60 Hz
 - Coupling to all lines, N, PE
 - 50Ω Burst output The coupling will be controlled by the compact NX5
 - Output for Surge coupling to other coupling networks as CNV models.
- **User software " iec.control "**
 - Test, analysis and documentation with Windows
 - License version for testing according the most automotive standards
 - Report generator with export function to word-processing software



UOC optical Interface

- **USB-Optolink Converter**
 - USB Optolink converter
 - Optical Fibre cable, 5m



9. EFT Burst as per IEC 61000-4-4

Burst Module 5/50 ns



Warning

If the user reduces the test voltage in **Quick Start** or in the **Manual Standard Test Routine**, the **storage capacitor will be discharged only by the burst pulses**. The result is a higher test voltage on the EUT than indicated on the display until the storage capacitor is discharged to the preselected value.

If the voltage reduction is several 100V the discharge time to the correct test voltage can be some seconds. The discharge time depends on the repetition rate t_r and the duration t_d of the burst pulse.

Pressing STOP / START will discharge the storage capacitor over the discharge resistor immediately. After the START the test will continue with the correct voltage level.

9.1. Operation

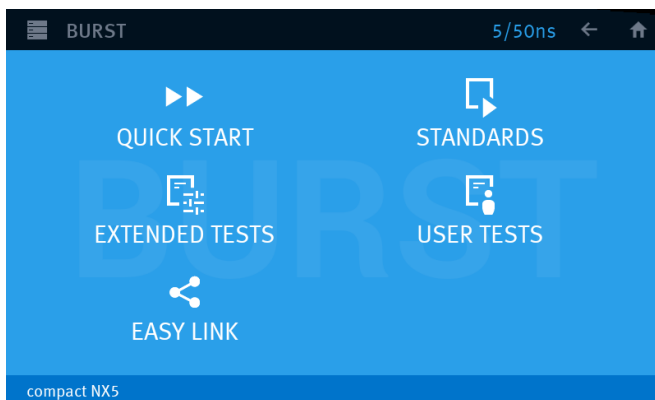

Main Menu Burst

The Burst menu offers different test routines for burst testing.

Quick Start

Easy and fast online-operation with the phenomenon Burst. In this menu the user can operate all burst test manually with online change the most parameters during a test.

Standard

The operator can select between various preprogrammed test routines as required in different standards. The standard library is filtered according to the EUT setting (AC, DC etc.)

Extended Tests

The operator can select between various preprogrammed test routines which helps to accelerate testing and which are very helpful especially during design.

User test routines

The user defined library where all created Burst tests are stored.

Easy Link

Link files library created during the actual session. The user can easily save a test into the Easy Link library. After switching off the Equipment all Easy Link tests are deleted. Use "SAVE AS USER TEST" for definitive save the test.

9.1.1. Quick Start

Easy and very fast operation of all standard functions of the equipment. The latest simulator settings are stored automatically and will be recalled when Quick Start is next selected.

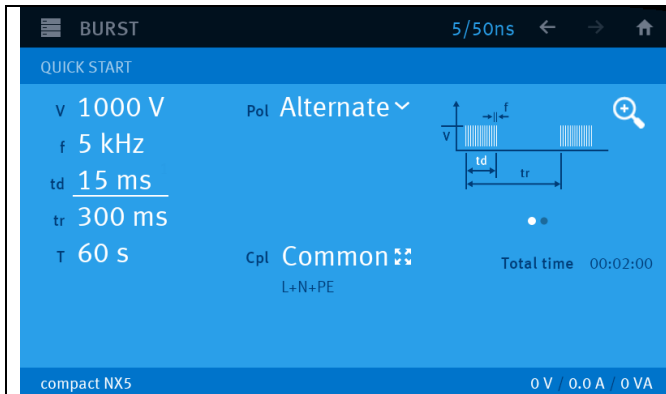

Quick Start Menu

Devices: **compact NX5**



Quick Start Menu

Devices: **compact NX5** and **coupling NX5**

Burst specification as per IEC 61000-4-4 Ed3 (2012)

f = 5kHz
td = 15ms
tr = 300ms

f = 100kHz
td = 0.75ms
tr = 300ms

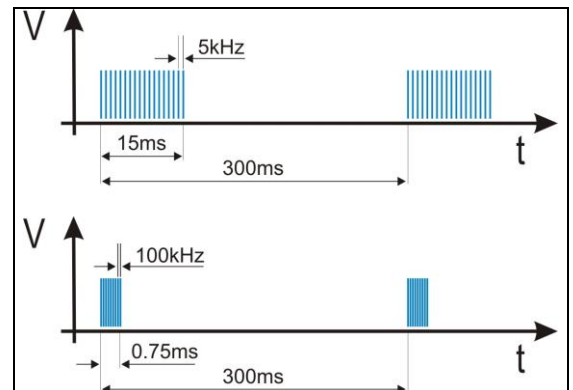

9.1.2. Standard test routines

The user can select preprogrammed standard test routines.

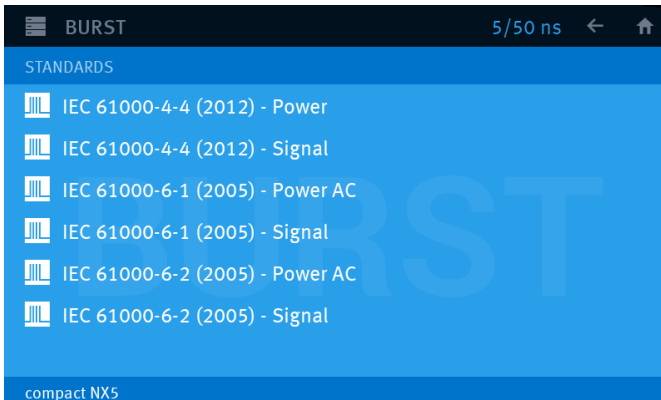

Standard Menu

Within this test routine all standard parameters can be changed online during testing at the **1-phase and coaxial 50 Ω output of the compact NX5** generator. This procedure therefore is very easy and fast to use.

The user can easy select the following parameters

- Level** (voltage): Select Level 1(500 V), Level 2(100 V), Level 3(2000 V), Level 4(4000 V)
- Coupling** (Cpl): Common (L+N+PE), All (All combinations (L, N, PE), 50 Ohm (coaxial output)
- Rep** (frequency): 5 kHz (td= 15 ms), 100 kHz (td= 0.75 ms)

9.1.3. Extended Test

The extended menu offers various useful tests for testing and development.

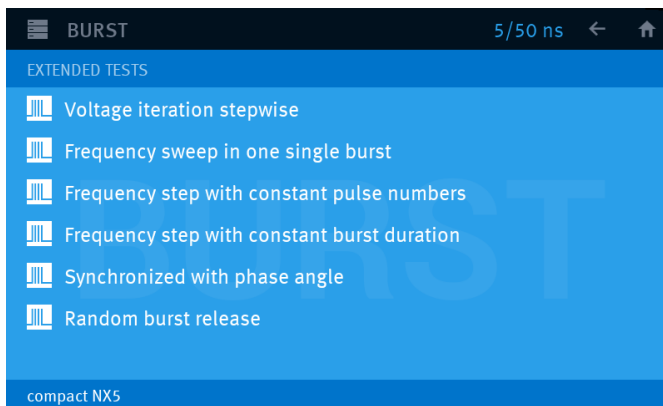

Extended Menu

Voltage iteration stepwise

Voltage change after T by ΔV . The test voltage is increased from V_1 to V_2 by steps of ΔV after the defined test time T . All limitations are the same as defined under Quick Start. The limitation of the max. generated number of spikes is related to the higher voltage of V_1 or V_2 .

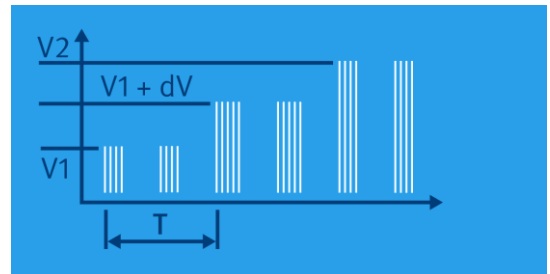

Frequency sweep in one single burst

During one single burst the frequency sweeps from f_1 to f_2 . For this function the following limitations have to be respected:

T_r	\geq	100 ms
f_1	\leq	f_2
T_d	\geq	5.0 ms
T_d	\geq	$5 / f_1$
$t_r - t_d$	\geq	50 ms

Note: The maximum value for frequency, burst duration t_d and voltage are in dependence of each other and therefore limited by the generator performance. The practical limits of the UCS500N7 are 20kHz for f_2 and 50ms for the burst duration t_d . The limits of the generator model compact NX5 N5 are approx. 10 times higher.

Frequency sweep with a constant duration after T by Δf

The spike frequency is increased from f_1 to f_2 by steps of Δf after the defined test time T . All limitations are the same as defined under Quick Start. The limitation of the max. generated number of spikes is related to the higher frequency of f_1 or f_2 .

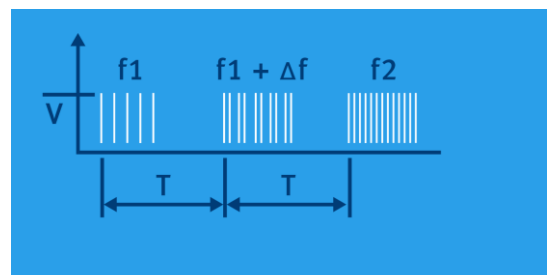

Frequency sweep with a constant pulse numbers

The burst duration is increased from t_{d1} to t_{d2} by steps of Δt_d after the defined test time T . All limitations are the same as defined under Quick Start. The limitation of the max. generated number of spikes is related to the higher duration of t_{d1} or t_{d2} .

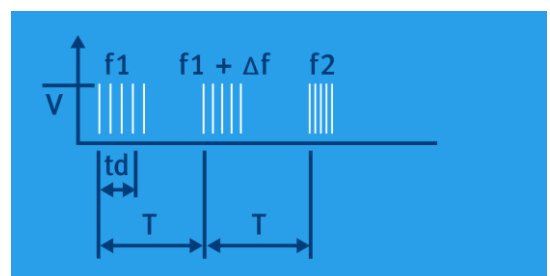

Synchronized with a fixed phase angle

The burst is triggered with respect to the phase angle of the power supply connected to the Sync input at the rear panel of the equipment. The power supply must be an AC voltage with a nominal frequency of 16 to 500Hz. The phase must be connected to L. This can be checked by the lamp connected to the L input.

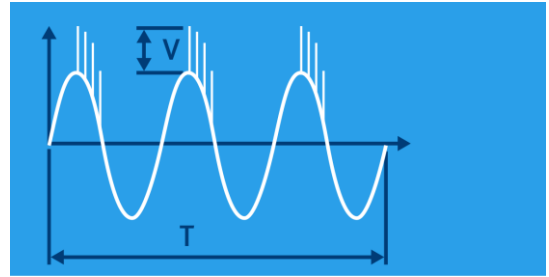

Random burst release

No repetition rate is selected. The single burst will be triggered by statistics in the limits of 20 to 2000ms as time between two bursts. All limitations are the same as defined under Quick Start.

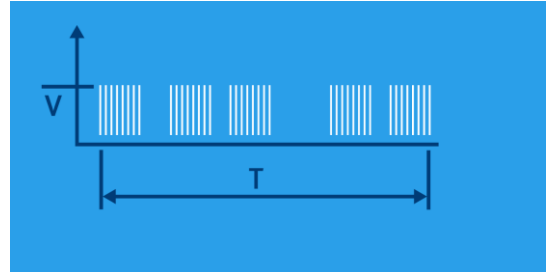

9.1.4. Max Burst impulses / s

Burst spike limit:

The pulse switch is a highly reproducible semiconductor switch. Spike frequencies up to 1000 kHz are by a factor of 10 higher than recommended in the actual EFT standards. This means of course that also the pulse energy would be 10 times higher. This is not generally possible for the high voltage switch. Therefore the following limitation protects the pulse forming circuit against overload:

Burst impulses / s

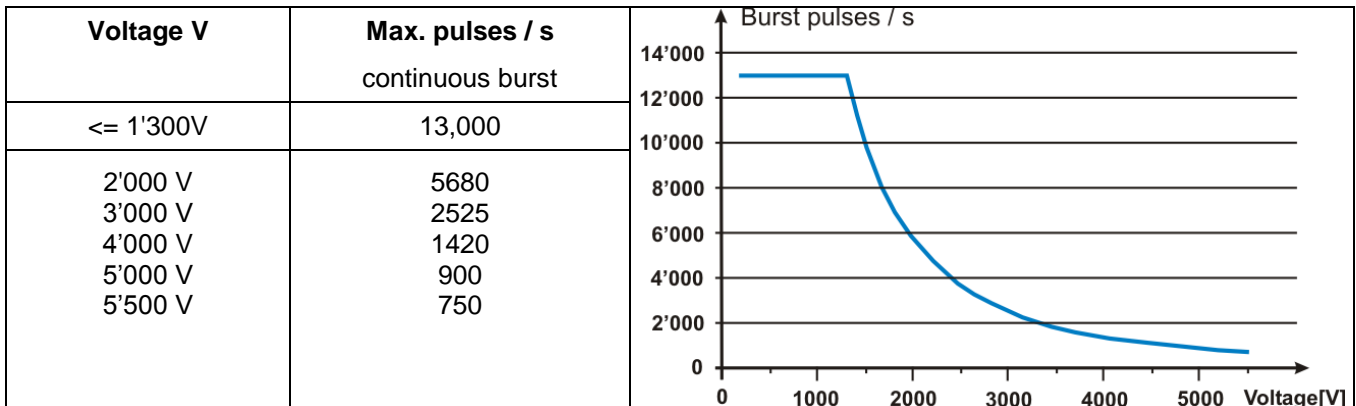

Error message :Cannot Start

The maximum energy of the burst impulses is limited to 30 J per second. This value is calculated by the formula:

$$\frac{U^2 * Td * f}{Trep} < 30 J$$

U [kV]
f [kHz]
Td, Trep [ms]

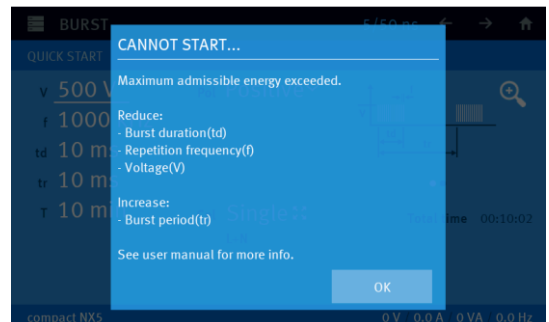

In case of this message the user must reduce the energy by changing at least one parameter

Reduce:

- Burst duration (Td)
- Repetition frequency (f)
- Voltage (V)

Increase:

- Burst period (td)

9.2. Burst Menu

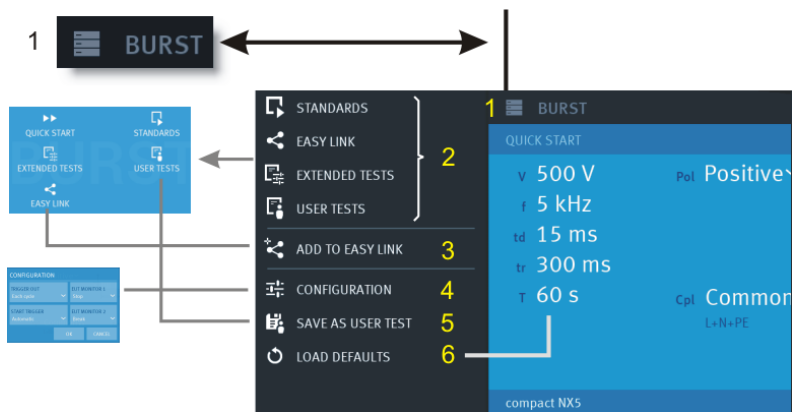

Burst Menu

- 1 Button for open and close the Burst Menu
- 2 Change to other Burst test routines. The last used test in this routine will be loaded.
 - Quick Start
 - Standards
 - Extended Tests
 - User Tests
 - Easy Test
- 3 Add the actual test to Easy Link library
- 4 Trigger and Monitor setting for Burst test (Each phenomenon has an individual configuration).
- 5 Add the actual test to User Test library
- 6 Load the default parameters for the Quick Start test (factory setting)

9.2.1. Configuration

In the configuration menu the user set the following parameters:

- **Trigger out signal** at the BNC plug on generator front side
- **Start trigger** for the impulse or event on the BNC Ext. Trigger plug on rear side or blinking Start button
- Behavior of the **EUT Monitor 1** and **EUT Monitor 2** on BNC plug on rear side

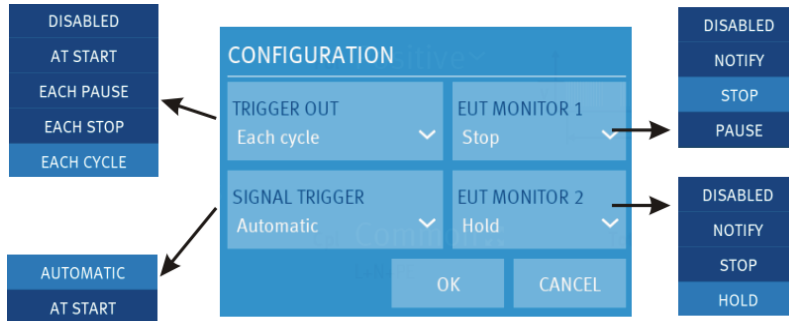

9.2.1.1. Trigger OUT

The trigger out signal is a programmable 5V edge signal located at the front side BNC Trigger plug. This signal is for trigger other devices like oscilloscopes or other devices.

The generator offers the following trigger out options:

- At **Start**
- Each **Pause (Break)**
- Each **Stop**
- Each **Cycle** every burst packet release

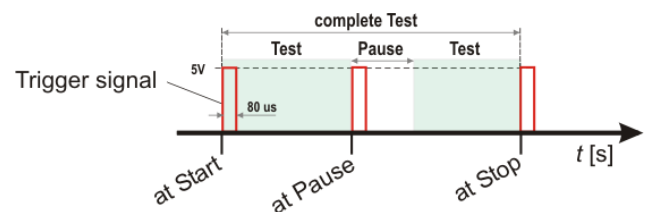

Iterations

For Iteration tests the parameters changes after each step as shown in the figure below. Depends of the order and setting the following parameters can change:

- Polarity
- Voltage
- Frequency
- Phase angle

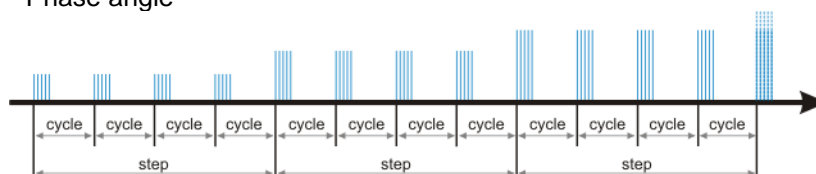

Example with voltage iteration that illustrate trigger out for cycle and step

9.2.1.2. Signal Trigger

The Signal Trigger occurs by pressing the blinking **START / PAUSE** button or with an external trigger positive slope signal at the rear side BNC **Ext. Trigger** plug.

The start trigger offers the following status:

- **Automatic**
- At **Start** (starts after the trigger)

If the start trigger is not set to Automatic, the trigger indicates with “**Waiting for trigger**” the recommended trigger signal.

The waiting time for a trigger signal is endless if no trigger timeout is enabled.

External trigger timeout

This function stops the test after the defined timeout time and indicates the message, “**Error trigger unit timeout**”.

For enable the function External trigger timeout select from the Home screen:

Menu / Setup / General / Process & sync

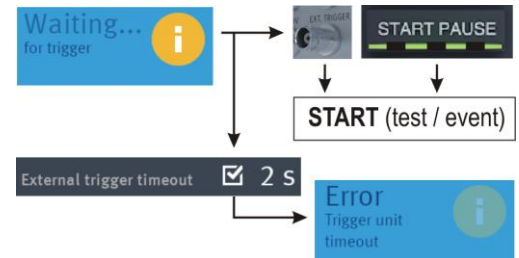

Start Trigger flowchart

9.2.1.3. EUT Monitor

The EUT monitor 1 and EUT Monitor 2 input is used for control the compact NX device according the EUT behavior. Each input is programmable to have different events as:

Disabled	No function
Notify	Makes a mark in the NX software. The report will make a time stamp and notes the actual generator settings.
Stop	Stops the test immediately. It is not possible to continue the test.
Pause (EUT monitor 1)	Break the test and go to pause status. For continue the user must press the START/PAUSE button or continue in iec.control software. NOTE: The EUT monitor input 1 must go to open status before press continue
Hold (EUT monitor 2)	Keep in pause status as long the EUT monitor 2 input is grounding. After release the break, the test will continue automatically.

EUT Monitor input signal

EUT Monitor Input

BNC plug on rear side of the compact NX generator



Status of BNC input of EUT monitor 1 / 2

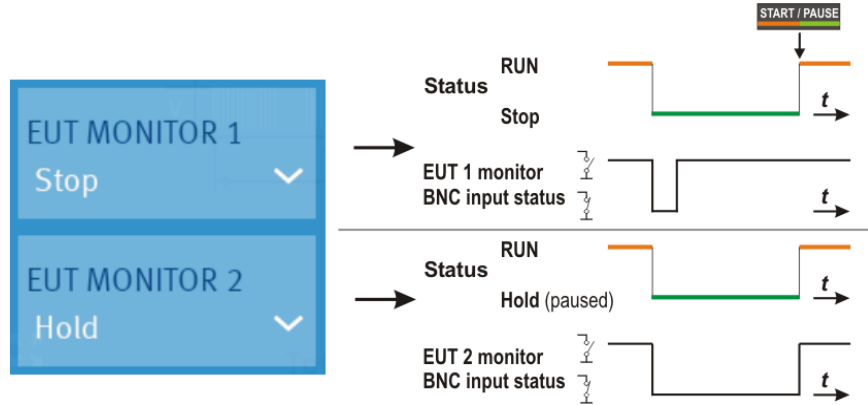

Input signal

Open collector signal 15 V to 0 V negative slope

Triger level

2 V ±1 V

Input impedance

>10 kΩ

Max. Input

+ 15 V

9.3. Burst generation

Burst switch:

The discharge switch is a highly reproducible semiconductor switch. Spike frequencies up to 1000 kHz are by a factor of 10 higher than recommended in the actual EFT standards. This means of course that also the pulse energy would be 10 times higher. This is not generally possible for the high voltage switch. Therefore the following limitation protects the pulse forming circuit against overload:

Pulses / s

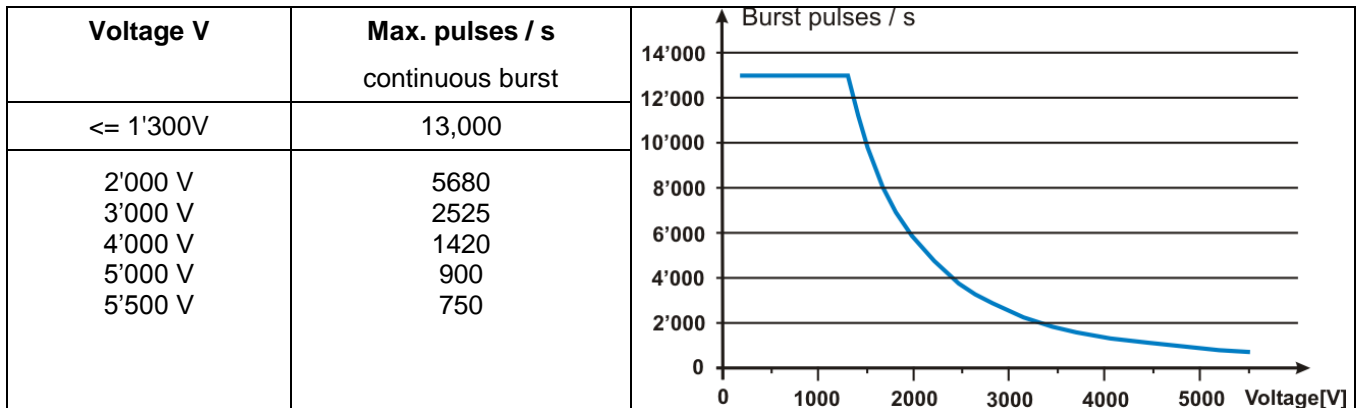

9.4. Test level with Burst as per IEC 61000-4-4

Burst generators, which the specifications in accordance with IEC 61000-4-4 are limited at the maximum output voltage. The efficiency of the burst pulses decreases with the numbers of couplings.

Therefore the maximum test level is limited by the number of coupling on several lines.

Coupling	compact NX5
50 Ω	5500V
1 coupling any	5500V
2 couplings any	5500V
3 couplings any	5500V

Generator with 3-phase CDN	
50 Ω output	5500V
1 coupling any	5500V
2 couplings any	5000V
3 couplings any	5000V
4 couplings any	4500V
5 couplings any	4500V

9.5. Coupling/decoupling network

The decoupling part of the coupling network has to:

- filter the interference pulses in the direction to the power supply;
- protect other systems that are connected to the same power supply and
- realize a high impedance of the power supply, e.g. battery supply.

9.5.1. Coupling/decoupling network for ac/dc power lines

The coupling network couples the EFT pulses via 33 nF capacitors onto the AC or DC power lines. As coupling devices capacitors of sufficient strength and bandwidth shall be used according to IEC 61000-4-4.

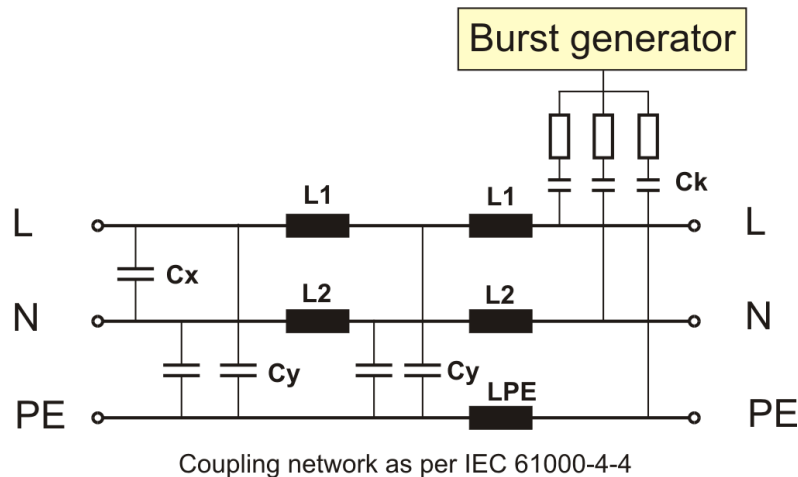

The coupling on signal lines can usually not be effected capacitive without interfering with the signal flow. It is often impossible to contact the required circuit (direct), e. g. coaxial or shielded cables. In this case the coupling is realized with the capacitive coupling clamp. The interference simulator can be connected on both sides of the coupling clamp.

Coupling method:

Test duration: At least 2 minutes in positive and negative polarity. The test duration must be at least as long for examine all functions of the EUT

Coupling IEC 61000-4-4 edition 2 (2004) and later versions requires to couple all lines simultaneously in Common Mode coupling. This means that a burst test needs **two tests with 60s** (positive and negative 60s each).

IEC 61000-4-4 (1995, 2001) requires **all line combination** to be tested individually. A 1-phase EUT needs to test all combination L, N, PE, L+N, L+PE, N+PE, L+N+PE each with two tests with 60s (positive and negative 60s each). Total test time 14 x 60 seconds

9.5.2. Capacitive coupling clamp

- The coupling clamp is not matched by 50 Ω . If the clamp is matched there exists an additional magnetic coupling, which may cause completely different test results.
- The clamp should be placed in a distance of 0.5m to the equipment under test. When the distance is shorter distances, the EUT may be influenced by radiation.
- If the EUT is includes two separate equipment, the test should be conducted on each single equipment with the required distance.



9.6. Burst Test Setup

- The test generator and the coupling network should be connected to the reference ground plane (acc. to high frequency requirements).
- The equipment under test must be isolated from the reference ground plane. The distance should be 10 cm. Being part of the EUT, these requirements are also recommended for all connected cables. The EUT should only be grounded if this is recommended by the installation guideline. For safety reasons, the test without any ground connection should be conducted as well (at 100MHz 1 m ground cable length has an impedance of about 600 Ω)
- Whenever possible the test set-up and the cabling should always be the same; e.g. for testing power lines it would be possible to fix the cables on the test table for all tests in the same way.
- Lines under test and all other lines should be decoupled strictly.

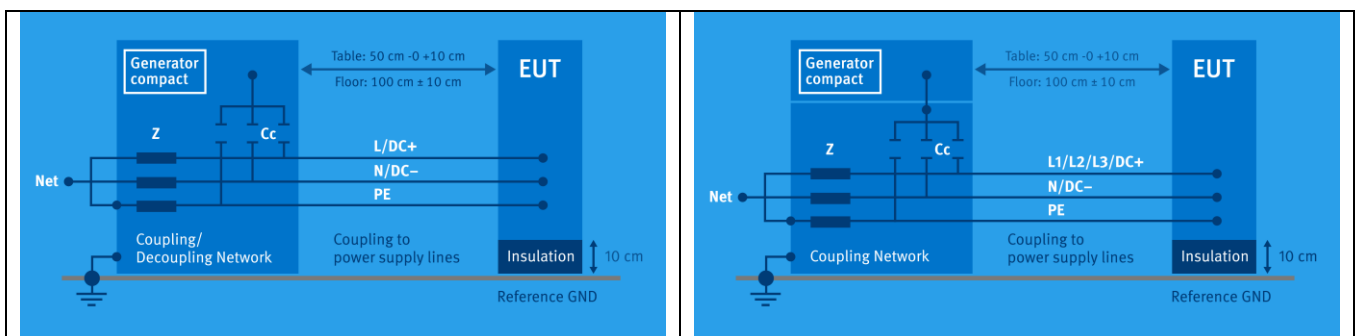
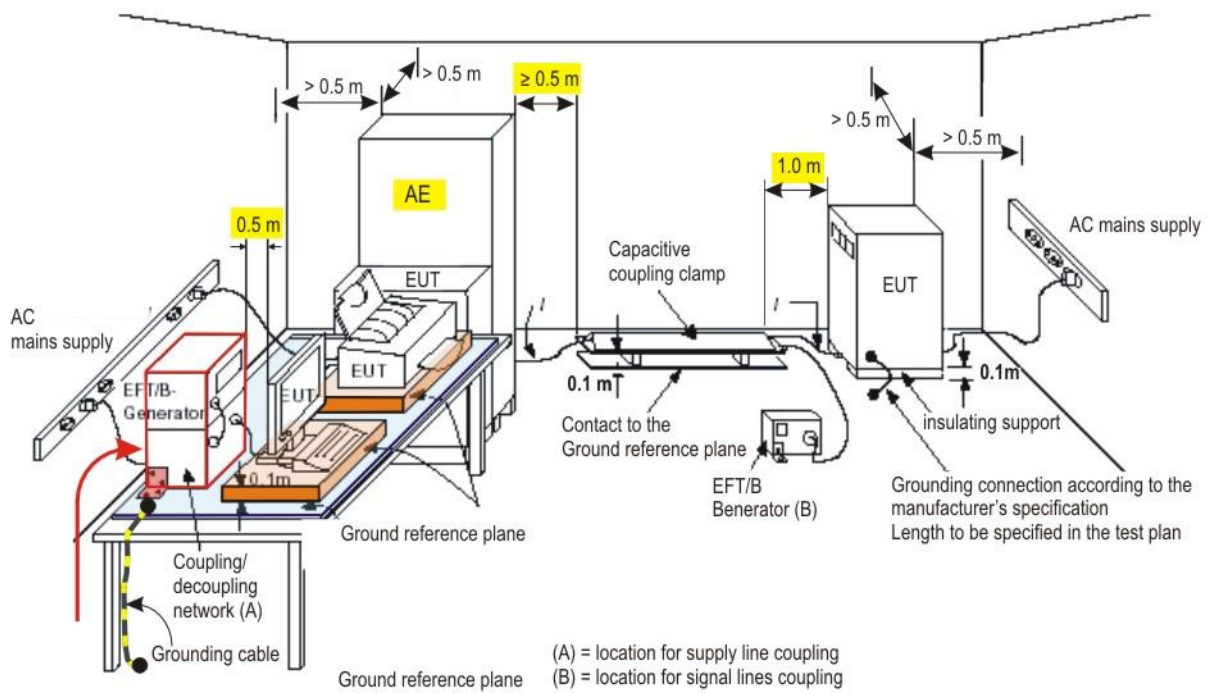

9.6.1. Test setup with capacitive coupling clamp

When using the coupling clamp, the minimum distance between the coupling plates and all other conductive surfaces (including the generator), except the ground reference plane beneath the coupling clamp and beneath the EUT, shall be at least 0.5 m.

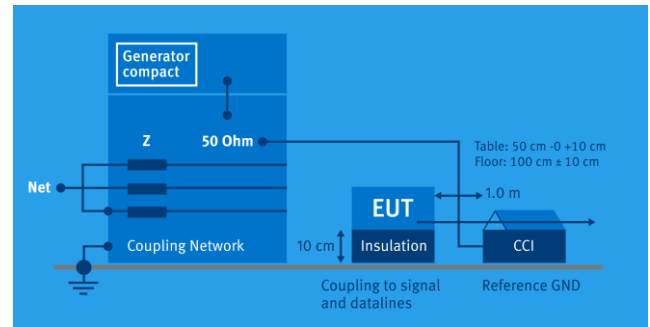
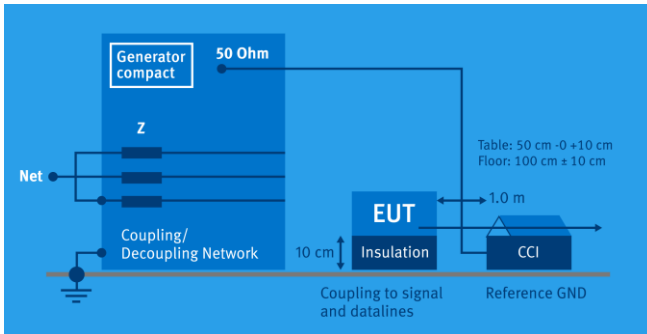

The distance between any coupling devices and the EUT shall be $(0.5 - 0/+0, 1)$ m for tabletop equipment testing, and $(1, 0 \pm 0, 1)$ m for floor standing equipment, unless otherwise specified in product standards. When it is not physically possible to apply the distances mentioned above, other distances can be used and shall be recorded in the test report.

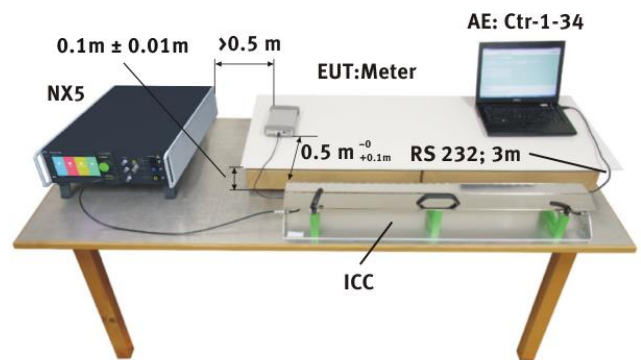

10. Surge Immunity as per IEC 61000-4-5

Surge Module 1.2/50 μ s – 8/20 μ s



WARNING

The internal coupling network is designed for **mains frequency 50 Hz / 60 Hz.**

When L – N coupling is selected an **additional current of approx. 1.5 A** flows, caused by the 18 μ F coupling capacitor and the pulse forming network. A similar current appears during the couplings to PE.

Tests with 400 Hz mains frequency **destroy the coupling network.** An external coupling network is recommended with inductors and capacitors matched to the 400 Hz mains frequency.

10.1. Operation

The Surge menu offers different test routines for burst testing.

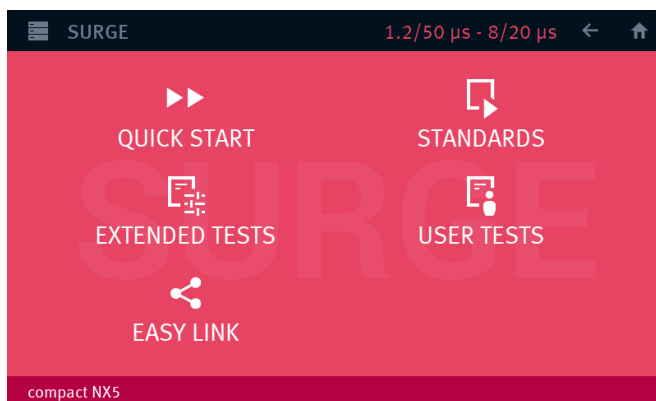

Main Menu Surge

The Surge menu offers different test routines for surge testing.

Quick Start

Easy and fast online-operation with the phenomenon Surge. In this menu the user can operate all surge test manually with online change the most parameters during a test.

Standard

The operator can select between various preprogrammed test routines as required in different standards. The standard library is filtered according to the EUT setting (AC, DC etc.)

Extended Tests

The operator can select between various preprogrammed test routines which helps to accelerate testing and which are very helpful especially during design.

User test routines

The user defined library where all created Surge tests are stored.

Easy Link

Link files library created during the actual session. The user can easily save a test into the Easy Link library. After switching off the equipment all Easy Link tests are deleted. Use "SAVE AS USER TEST" for definitive save the test.

10.1.1. Quick Start

Easy and very fast operation of all standard functions of the equipment. The latest simulator settings are stored automatically and will be recalled when Quick Start is next selected.

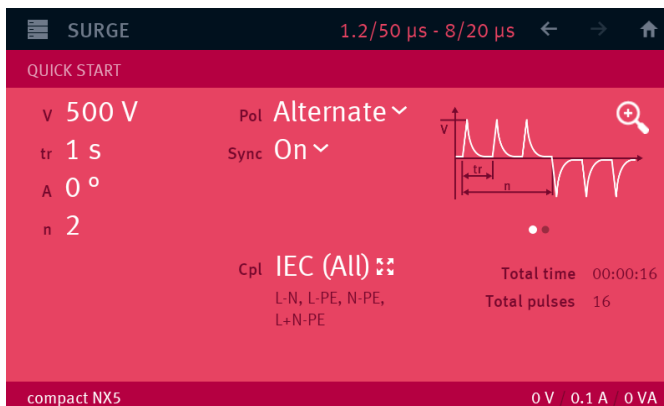

Quick Start Menu

While a test is running the user can select parameters. The selected parameter then can be changed online with the inc/dec knob.

10.1.2. Standard test Routine

The user can select preprogrammed standard test routines.



The Surge Standard menu offers a list of standards. The name of the standard defines the characteristic of the rulers that is given in the application of the standard.

The standard name has the character: **[Standard Family], [Standard number], [year], [Application]**, where

Standard Family

IEC: *International Electrotechnical Commission*

EN: *European Committee for Standardization (CEN)*

Standard Number

Indicates the official standard number defined in the standard.

Year

Year of standard publication. The year indicates the different standard publication. The year is used for follow the definitions specified in this publication.

Application

Specifies different applications or EUT characteristics

- One level: only one test level will be in this test. The user can select the test level (level 1 to 4)
- All levels: The test procedures start at the lowest level and increase to the level specified.

Iteration of the standard test procedure as per IEC 61000-4-5

The surges have to be applied synchronized to the voltage phase at the respective angle and the peak value of the a.c. voltage wave (positive and negative).

The surges have to be applied line to line and line(s) and earth. When testing line to earth the test voltage has to be applied successively between each of the lines and earth.

The test voltage has to be increased by steps from the lowest test level up to the test level specified in the product standard or test plan.

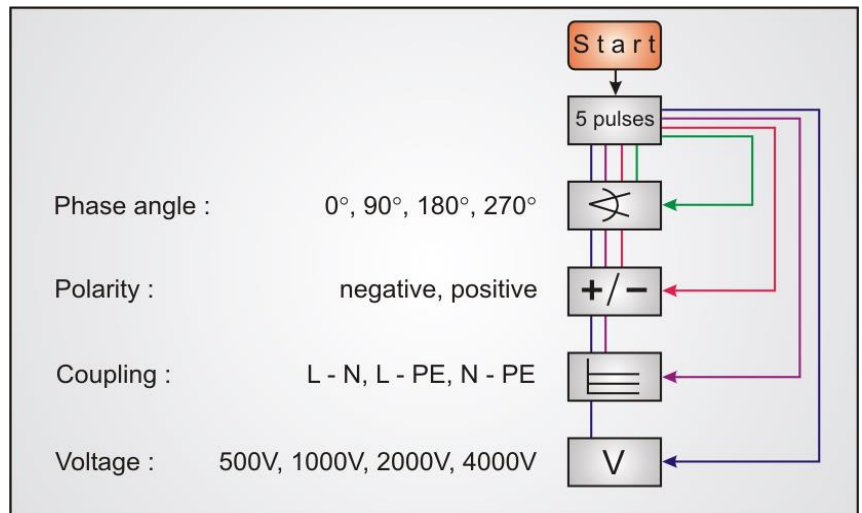

List of settings EN 61000-6-1 (each setting with 5 pulses)

Setting	Voltage	Coupling	Polarity	Phase angle
1	500	L-N	pos	0
2				90
3				180
4				270
5			neg	0
6				90
7				180
8				270
9		L-PE	pos	0
10				90
11				180
12				270
13			neg	0
14				90
15				180
16				270
17		N-PE	pos	0
18				90
19				180
20				270
21			neg	0
22				90
23				180
24				270
25	1000	L-N	pos	0
26				90
27				180
28				270
29			neg	0
30				90
31				180
32				270

Setting	Voltage	Coupling	Polarity	Phase angle
33	1000	L-PE	pos	0
34				90
35				180
36				270
37			neg	0
38				90
39				180
40				270
41		N-PE	pos	0
42				90
43				180
44				270
45			neg	0
46				90
47				180
48				270
49	2000	L-PE	pos	0
50				90
51				180
52				270
53			neg	0
54				90
55				180
56				270
57		N-PE	pos	0
58				90
59				180
60				270
57			neg	0
58				90
59				180
60				270

Within this test routine all standard parameters can be changed online during testing. This procedure therefore is very easy and fast to use.

10.1.3. User Test Routines

The user can program, save and recall his own specific test routines. The next pages show the selection of the functions.

The extended menu offers various useful tests for testing and development.

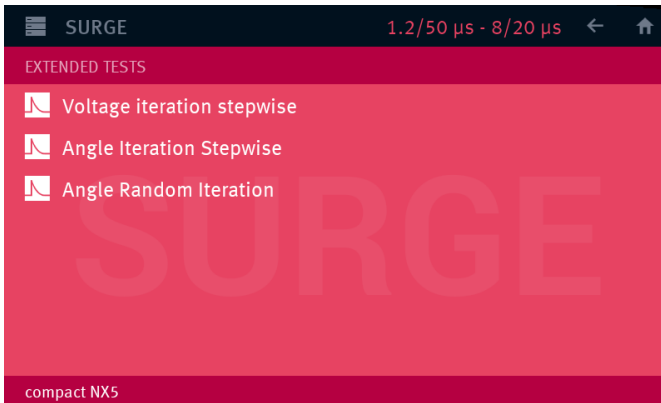

Extended Menu

Change test level V after n pulses by ΔV

The test voltage V is changed from V1 to V2. After the preselected number pulses the test level is changed by ΔV until V2 is reached. The same parameters as under Quick Start are selectable. For the limitation of the max. admissible repetition rate the higher value of V1 and V2 is valid.

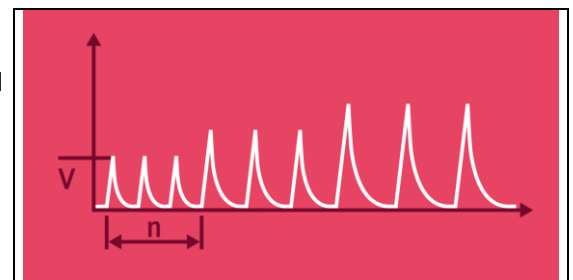

Angle Iteration Stepwise after n pulses by ΔA

The phase angle related to which the surge pulse is released is changed from A1 to A2. After the preselected number of n pulses the actual phase angle is changed by ΔA until A2 is reached. The same parameters as under Quick Start can be selected.

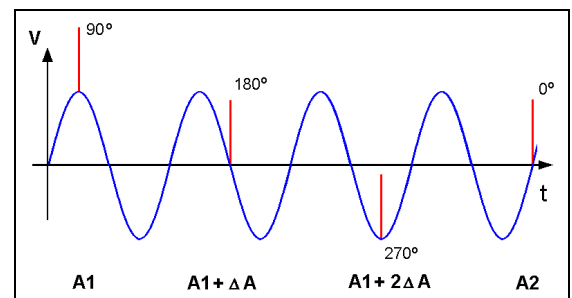

Angle Random Iteration

The phase iterated angle will be played in random mode. After the test all steps are tested once.

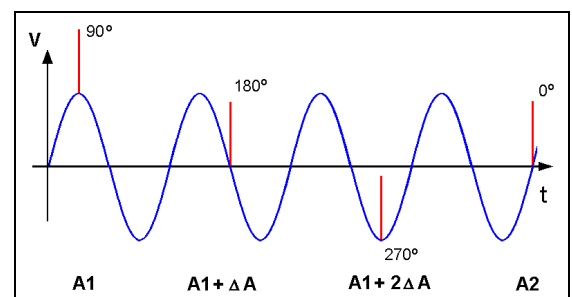

This Function is actually not implemented

ANSI A coupling after n pulses

The coupling mode with 12Ω and $9\mu\text{F}$ will automatically be changed after the preselected number of pulses has been released. All possible coupling modes will be selected. The same parameters as under Quick Start can be selected.

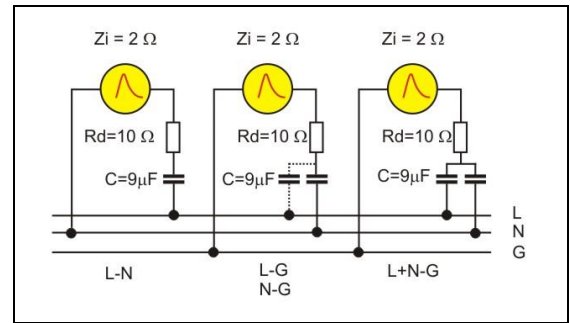

ANSI B coupling after n pulses

The coupling mode with 2Ω and $18\mu\text{F}$ will automatically be changed after the preselected number of pulses has been released. All possible coupling modes will be selected. The same parameters as under Quick Start can be selected.

For coupling ANSI B **coupling L-N** is actually **not supported** with NX system.

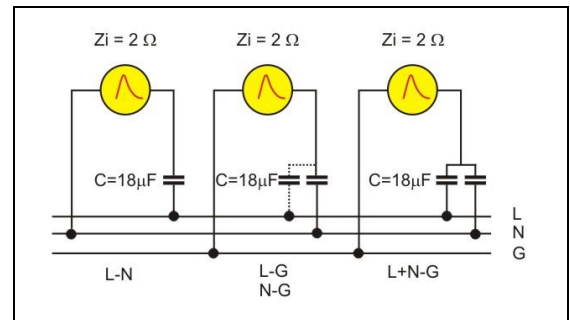

Surge Generator and coupling impedances

	Line to Line	Line to PE Line to GND (IEC) (ANSI)
IEC	2Ω ; $18\mu\text{F}$	12Ω ; $9\mu\text{F}$
ANSI A	12Ω ; $9\mu\text{F}$	12Ω ; $9\mu\text{F}$
ANSI B	2Ω ; $18\mu\text{F}$	2Ω ; $18\mu\text{F}$

10.2. Surge Menu

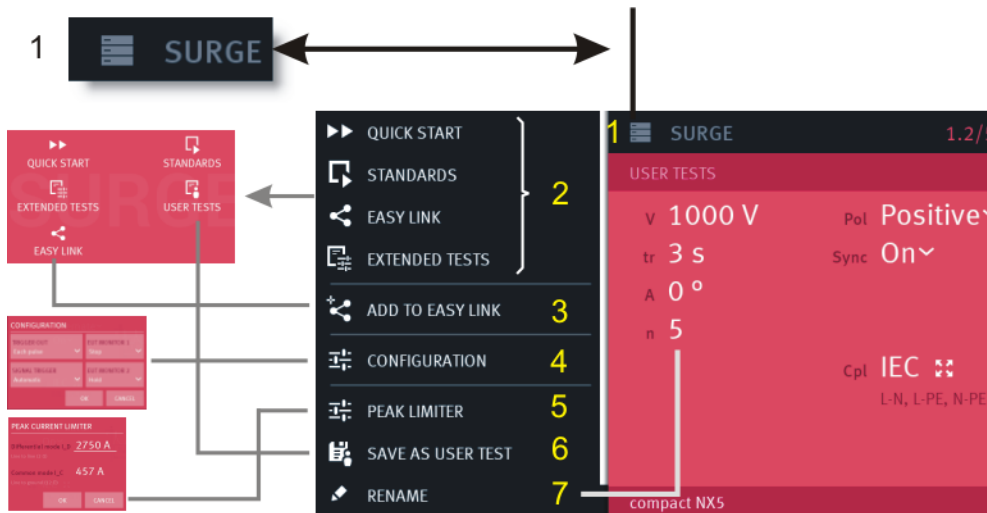

Surge Menu

- 1 Button for open and close the Surge Menu
- 2 Change to other Surge test routines. The last used test in this routine will be loaded.
 - Quick Start
 - Standards
 - Extended Tests
 - User Tests
 - Easy Test
- 3 Add the actual test to Easy Link library
- 4 Trigger and Monitor setting for Surge test. (Each phenomenon has an individual configuration)
- 5 Current limiter setting
- 6 Add the actual test to User Test library
- 7 Load the default parameters for the Quick Start test (factory setting)

10.3. Surge pulse settings

10.3.1. Configuration

In the configuration menu the user set the following parameters:

- **Trigger out signal** at the BNC plug on generator front side
- **Signal trigger** for the impulse or event on the BNC Ext. Trigger plug on rear side or blinking Start button
- Behavior of the **EUT Monitor 1** and **EUT Monitor 2** on BNC plug on rear side

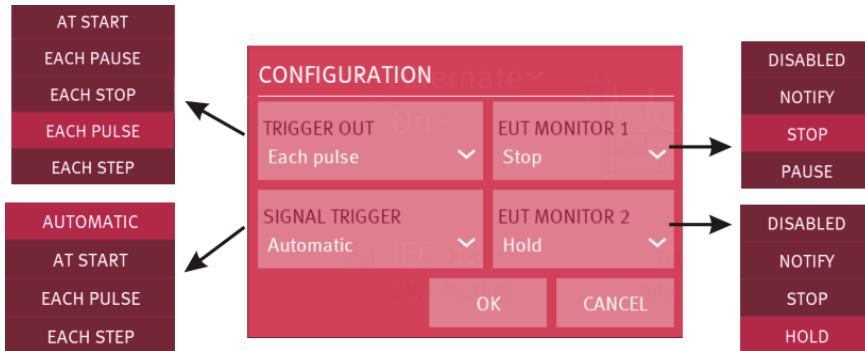

10.3.1.1. Trigger OUT

The trigger out signal is a programmable 5V edge signal located at the front side BNC Trigger plug. This signal is for trigger other devices like oscilloscopes or other devices.

The generator offers the following trigger out options:

- At **Start**
- Each **Pause**
- Each **Stop**
- Each **Pulse** every surge impulse release for tests with iteration
- Each **Step**

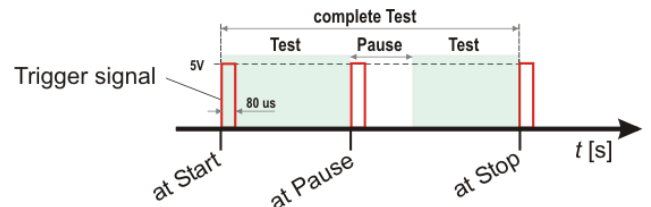

Iterations

For Iteration tests the parameters changes after each step as shown in the figure below. Depends of the order and setting the following parameters can change:

- Polarity
- Voltage
- Phase angle

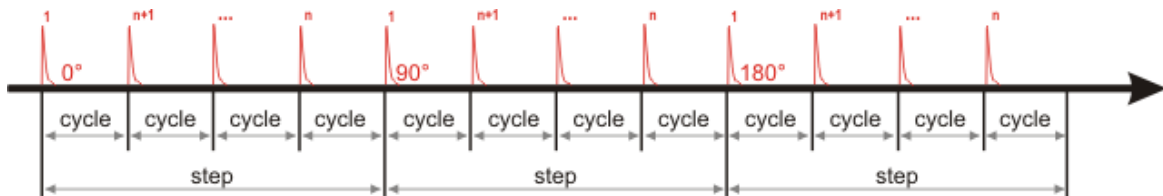

Example with voltage iteration that illustrate trigger out for cycle and step

10.3.1.2. Start Trigger

The Start Trigger occurs by pressing the blinking **START / PAUSE** button or with an external trigger positive slope signal at the rear side BNC **Ext. Trigger** plug.

The start trigger offers the following status:

- **Automatic**
- At **Start** (starts after the trigger)
- Each **pulse** (same as trigger out)
- Each **step** (same as trigger out)

If the start trigger is not set to Automatic, the trigger indicates with “**Waiting for trigger**” the recommended trigger signal.

The waiting time for a trigger signal is endless if no trigger timeout is enabled.

External trigger timeout

This function stops the test after the defined timeout time and indicates the message, “**Error trigger unit timeout**”.

For enable the function External trigger timeout select from the Home screen:

Menu / Setup / General / Process & sync

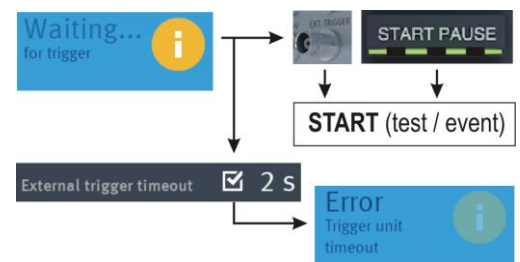

Start Trigger flowchart example from burst

10.3.1.3. EUT Monitor

The EUT monitor 1 and EUT Monitor 2 input is used for control the compact NX device according the EUT behavior. Each input is programmable to have different events as:

Disabled	No function
Notify	Makes a mark in the NX software. The report will make a time stamp and notes the actual generator settings.
Stop	Stops the test immediately. It is not possible to continue the test.
Break (EUT monitor 1)	Break the test and go to pause status. For continue the user must press the START/PAUSE button or continue in iec.control software. NOTE: The EUT monitor input 1 must go to open status before press continue
Break (hold) (EUT monitor 2)	Keep in pause status as long the EUT monitor 2 input is grounding. After release the break, the test will continue automatically.

EUT Monitor input signal

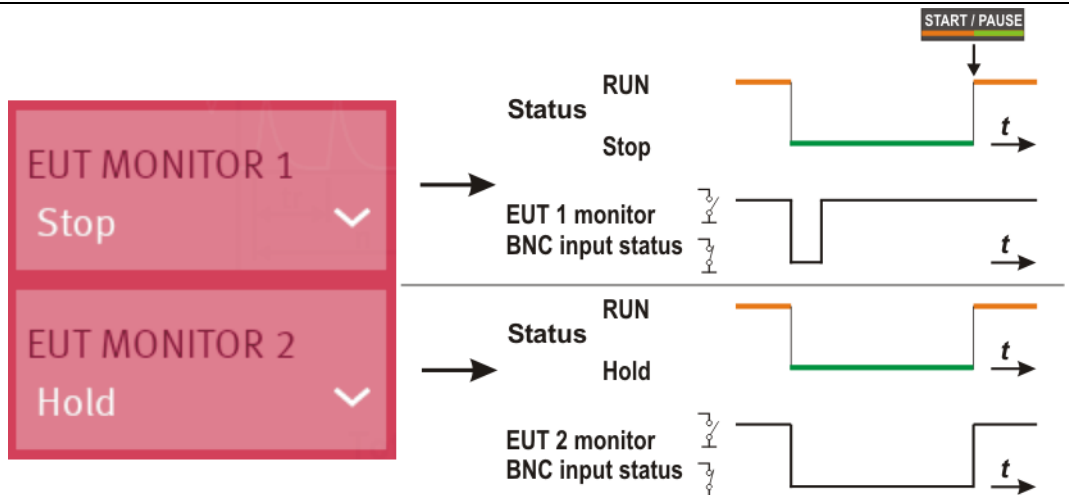
EUT Monitor Input	BNC plug on rear side of the compact NX generator  EUT Monitor 1 EUT Monitor 2
Status of BNC input of EUT monitor 1 / 2	
Input signal	Open collector signal 15 V to 0 V negative slope
Triger level	2 V \pm 1 V
Input impedance	>10 k Ω
Max. Input	+ 15 V

10.3.2. Setup current peak limiter for surge current

The peak current limiter stops the test run when during a test the measured peak current of a surge pulse is higher than the preselected current value. This safety function protects the EUT for further surge pulses that can become any dangerous situation.

Depends of the different impedance of the surge generator, one current limiter for both impedances ($2\ \Omega$, $12\ \Omega$) is available.

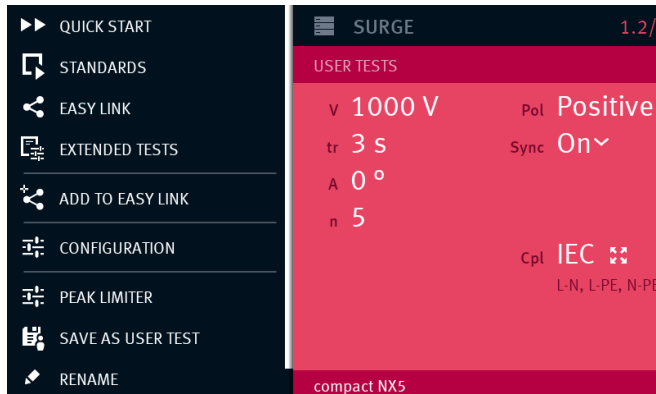

Select SURGE Menu / Current Limiter

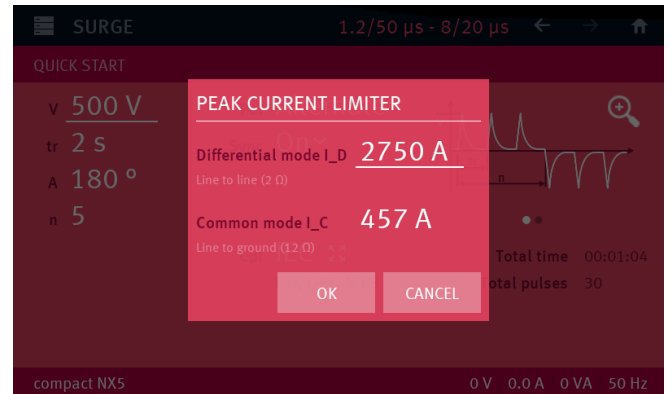

Set peak current limiters

I_D = Current limiter Differential mode (line to line):

The generator impedance is $2\ \Omega$

I_C = Current limiter Common mode (line to ground):

The generator impedance is $12\ \Omega$



REMARK

The current limits in Software and Manual operation are two individual settings.

Software uses the **software settings** for **I_D** and **I_C**

Manual operating uses the **device settings** for **I_D** and **I_C**

Note:

Surge pulses with the coupling position for data lines use the settings of common mode. This is general used for the coupling network CNV 504 / 508 series with have an impedance of $42\ \Omega$ ($2\ \Omega + 40\ \Omega$). Using a coupling network coupling NX-series uses the limits of differential and common mode.

10.3.3. HV-COM output (18 μ F capacitor)

The HV – COM output includes a configurable output capacity with 18 μ F. Using EM TEST coupling-decoupling networks, the coupling capacitor is part of the CDN. For other applications e.g. pulsed surge magnetic field or a surge verification requires an 18 μ F capacitor in the circuit. The NX generator includes a configurable 18 μ F capacitor at the HV – COM output.

Application with 18 μ F capacitor

- Pulsed magnetic field application to a single turn antenna as per IEC 61000-4-9
- Generator pulse verification at the NX5 HV-COM output
- Pulse verification at the coupler HV-COM output
- Application to any external CDN not from EM TEST manufactured

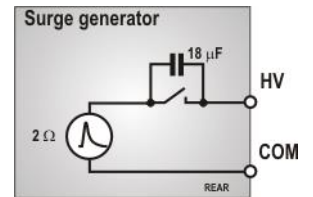

Application without 18 μ F capacitor

- Using a coupling decoupling network from EM TEST.

REMARK: All CDN from EM TEST includes a built in coupling capacitor. The values are 18 μ F, 9 μ F, 0.5 μ F or any other special value according the application.

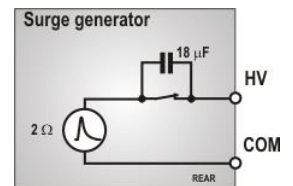

Capacitor setting

For set the 18 μ F capacitor use menu

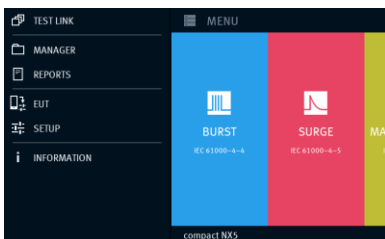

MENU / SETUP /

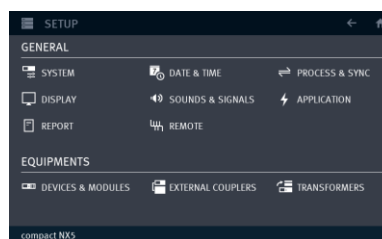

APPLICATION

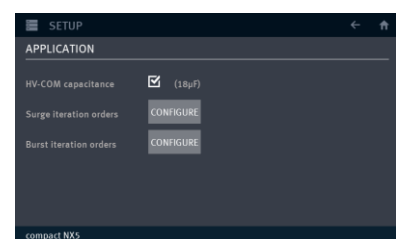

10.4. Surge pulse application

10.4.1. Phase synchronization in 3-phase system

The synchronization in a 3-phase coupler system is taken from the phase L1 and neutral. In case of a delta supply without neutral connected, an artificial neutral point is defined by a high impedance network. This artificial neutral is taken for the phase synchronization.

For all couplings the generator calculates the correct phase angle for phase triggering.

In case of too high phase shifting the user can connect a proper sync signal to the SYNC IN plugs at the rear side of the compact NX generator

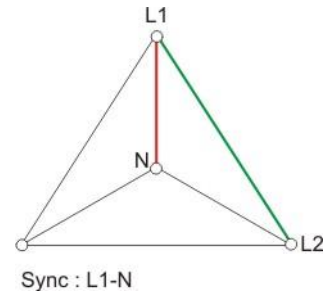

The tables below shows the correction angels considering the phase in a 3-phase system with synchronization signal from L1-N lines. The generator firmware will automatically add the correction angle to the settled value.

Phase Synchronization correction for L1-N as sync signal

Coupling	Sync. Source	Correction angel added by the compact NX5 firmware					
	L1-N	L1-N	L2-N	L3-N	L1-L2	L1-L3	L2-L3
Sync.- Angel	0°	0°	120°	240°	330°	30°	90°
	90°	0°	210°	300°	60°	120°	180°
	180°	0°	300°	30°	150°	210°	270°
	270°	0°	30°	150°	240°	300°	0°

The correct phase angle will be set automatically from the compact NX5 N.

10.4.2. Charging time for surge

The energy for charging the surge generator depends on the charging voltage of the internal capacitor of 11 uF therefore the following minimum charging time is requested:

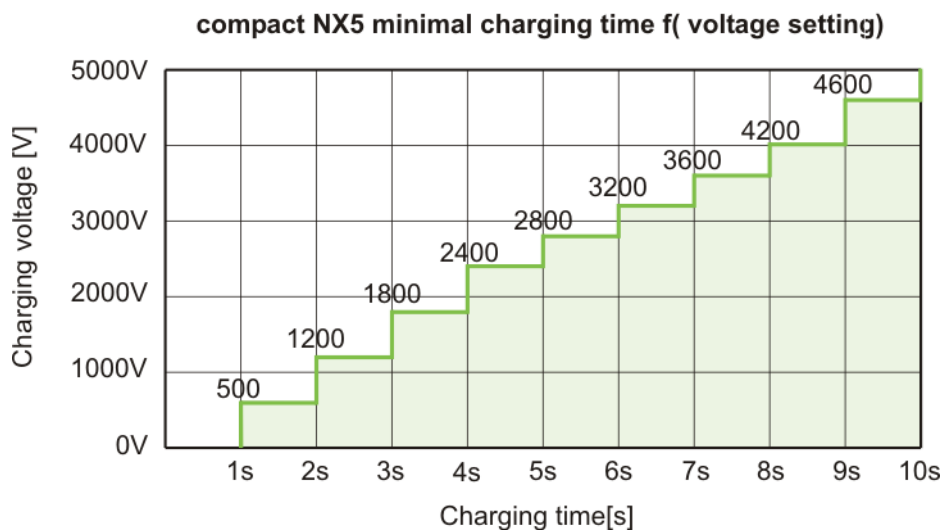

10.5. Surge pulse application

Discharge switch:

The discharge switch is a highly reproducible semiconductor switch.

10.6. Coupling/decoupling network

The coupling network has to couple the interference pulses to the lines of a power supply system (AC or DC). Capacitive coupling is the specified coupling mode for surge testing.

10.6.1. Coupling to AC/DC power supply lines

The surge generator compact NX5 has an integrated coupling network in accordance with IEC 61000-4-5. It must be possible to test with different coupling modes:

Line	→	GND or	(source impedance is 12Ω)
Neutral	→	GND or	(source impedance is 12Ω)
L + N	→	GND or	(source impedance is 12Ω)
Line	→	Neutral	(source impedance is 2Ω)

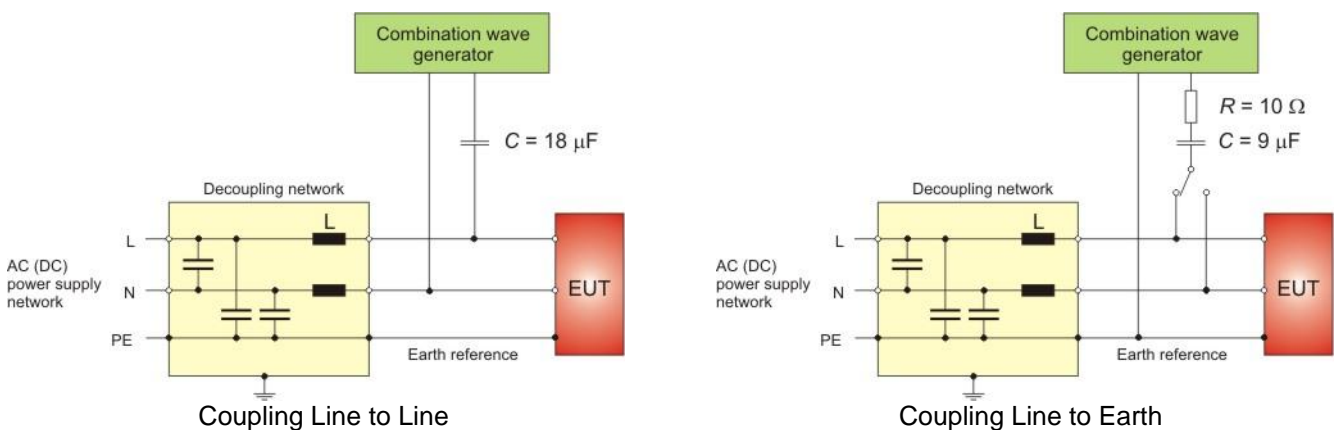

The release of the surge pulses is mostly related to a certain phase angle.

The surge pulses are synchronized to the input signal at the rear Sync-connector.

Attention: The decoupling part of the coupling/decoupling network includes some capacitors for filtering of $20\mu\text{F}$ related to protective Earth (chassis of the generator). This is to conform to the requirement of IEC 61000-4-5 concerning attenuation of the surge transients in direction to the power mains supply input of the CDN.

As consequence there will exist an increased current to PE (protective earth) which might be hazardous to the operator in case of a failure or wrong installation. Therefore, it is very important to take the following points into account before setting the generator into full operation.

1. Due to this increased current into the PE system no earth fault current protectors can be used within a surge testing area.
2. As consequence the surge generator shall be connected always to Protective Earth, even if no test is conducted.
 - via plugged in power mains supply cable including the PE wire !!!!
 - via plugged in EUT power mains supply at the rear side of the generator, including the PE wire !!!!
 - via Ground Reference Connector, screwed to the chassis of the generator.

These measures result in double safety in case of a fault

10.6.2. Coupling to I/O lines

The coupling to I/O lines is generally realized with other coupling networks than for power supply lines. The loading of the I/O lines with big coupling capacitors is mostly not possible. The data transmission may be disturbed.

For coupling to I/O lines special couplers according the Standard IEC 61000-4-5 are available, such as the CDN CNV 504N- and the CNV 508N-series for four respectively for eight wire systems.

For many applications a special coupling network is required.

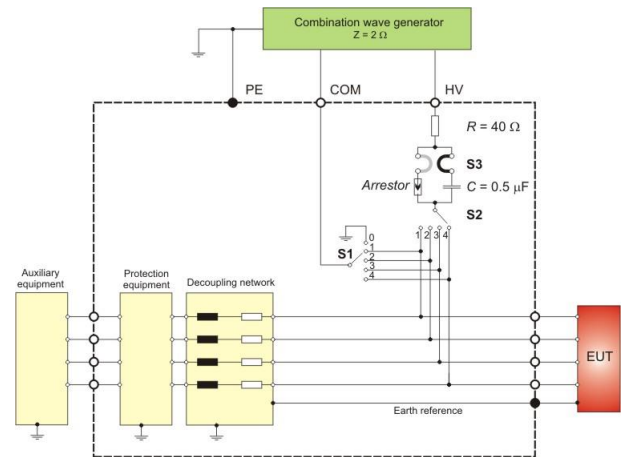

Danger

Using coupling networks CNV series
Switch OFF the high voltage during manual change of the coupling

10.7. Test set-up

According to the specifications of IEC 61000-4-5, the surge generator has a source impedance of 12Ω when the simulator is coupled between the lines and protective earth.

This will activate fault current detectors or protectors which may be installed in the laboratory.

Therefore it is important

- not to disconnect the surge simulator from protective earth (power cable)
- to have an installation where the simulator is connected via its ground reference connector to earth

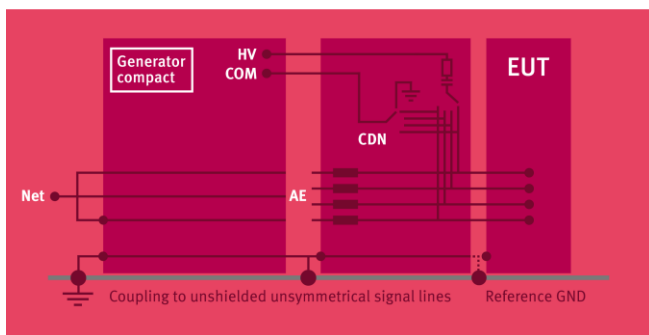

Setup for unsymmetrical data lines

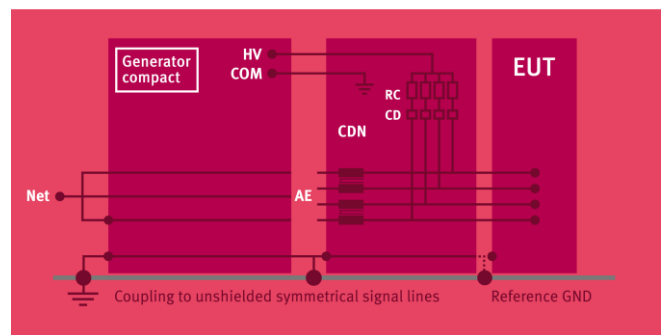

Setup for symmetrical data lines

11. Magnetic field test as per IEC 61000-4-9

Pulsed Magnetic field as per IEC 61000-4-Surge Module 1.2/50 μ s – 8/20 μ s

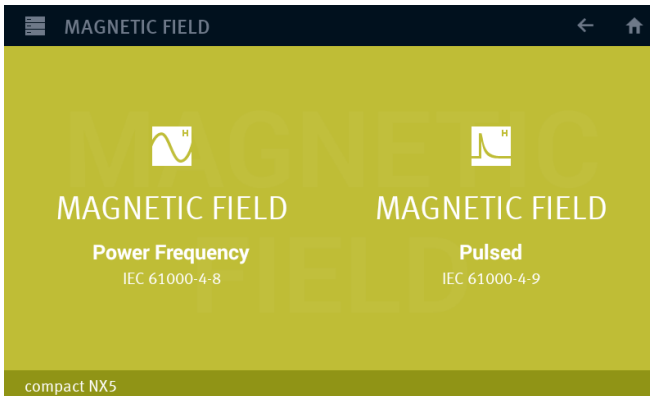

Main Menu Magnetic Field



WARNING

The internal coupling network is designed for **mains frequency 50 Hz / 60 Hz.**

When L – N coupling is selected an **additional current of approx. 1.5 A** flows, caused by the 18 μ F coupling capacitor and the pulse forming network. A similar current appears during the couplings to PE.

Tests with 400 Hz mains frequency **destroy the coupling network.** An external coupling network is recommended with inductors and capacitors matched to the 400 Hz mains frequency.

11.1. Pulsed Magnetic field as per IEC 61000-4-9

The menu offers different test routines for pulsed magnetic field testing.

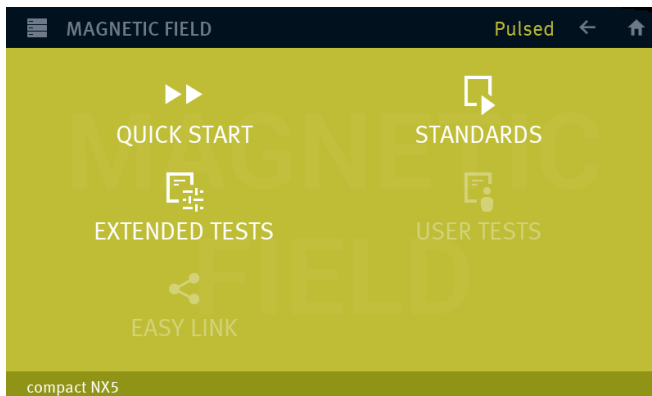

Main Menu Pulsed Magnetic Field

The Magnetic Field menu offers different test routines for pulsed magnetic testing.

Quick Start

Easy and fast online-operation with the magnetic Surge phenomenon. In this menu the user can operate all test manually with online change the most parameters during a test.

Standard

The operator can select between various preprogrammed test routines as required in different standards. The standard library is filtered according to the EUT setting (AC, DC etc.)

Extended Tests

The operator can select between various preprogrammed test routines which help to accelerate testing and which are very helpful especially during design.

User test routines

The user-defined library where all created magnetic field tests are stored.

Easy Link

Link files library created during the actual session. The user can easily save a test into the Easy Link library. After switching off the equipment, all Easy Link tests are deleted. Use "SAVE AS USER TEST" for definitive save the test.

For magnetic field testing the antenna correction factor shall be included. The operator can enter this factor within the setup menu under the service routine.

Setup pulsed magnetic Test field

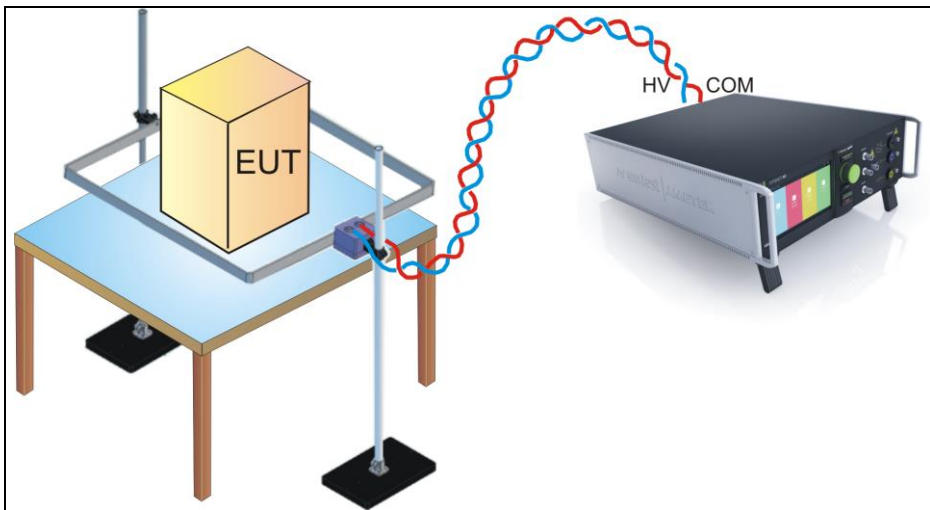
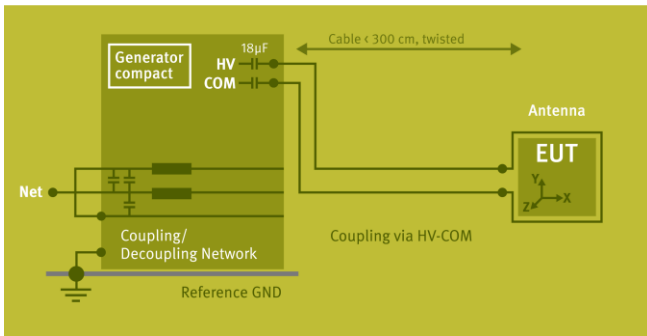

Warning

Disconnect all power cables on the rear side at the Test supply plugs.

PF1, PF2 and N

Don't touch the antenna during the test!

12. Voltage Dips and Interruptions as per IEC 61000-4-11

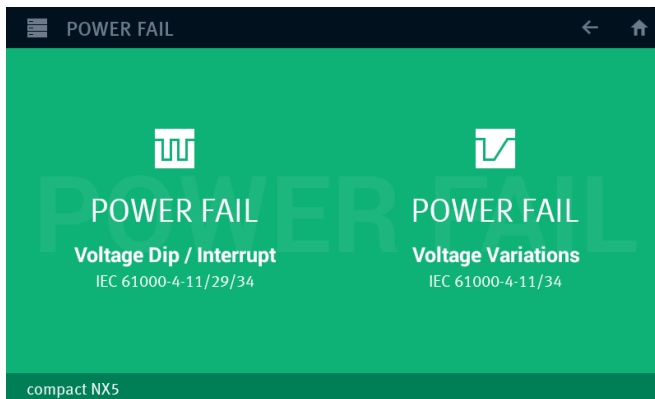

Main Menu Power Fail for voltage dips and interrupt tests and voltage variation

12.1. Test setup for DIPS and Interruption tests

Voltage DIPS

For voltage DIPS a connection must be made from the compact NX PF2 input to the motorvariatic PF2 or V4780, where the reduced voltage is present.

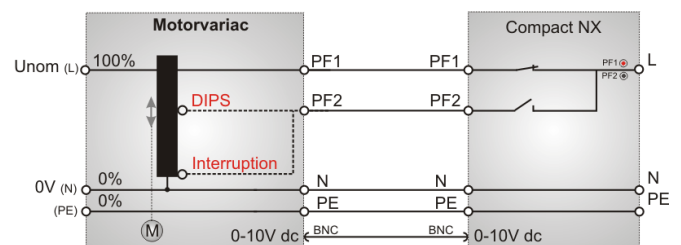

Interruption tests

For Interrupts connect the compact NX PF2 input to the neutral as follows:

- **Motorvariatic** : PF2 output (default setting) set motorvariatic to zero volt.
- **V 4780** : Connect the cable to the N output at the V 4780

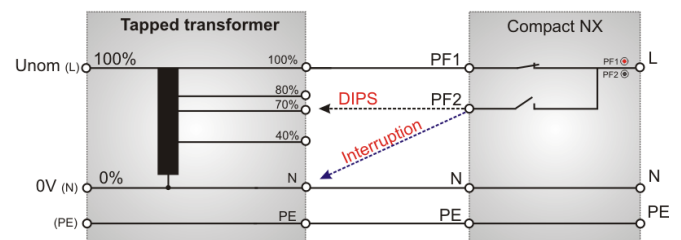

Setup for dU mode

The generator is connected as follow:

PF1: Mains voltage from the grid

PF2: Reduced voltage preset for the dip test. Mostly set to 40%, 70% or 80% of the mains voltage

The internal generator switch will change the EUT supply voltage between PF1 and reduced PF2 voltage.

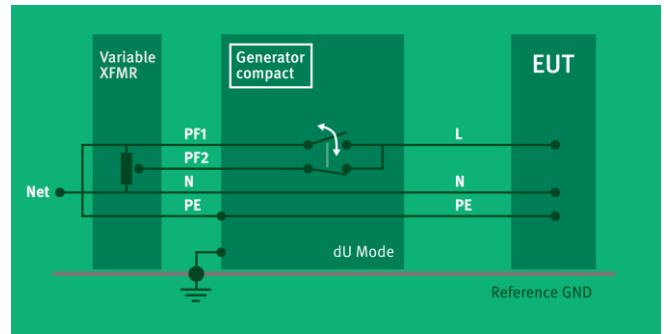

Setup for PF1 mode

The generator is connected as follow:

PF1: Mains voltage from the grid

PF2: Switch is open during the test

The generator switch will PF1 for interrupt the supply voltage to the EUT

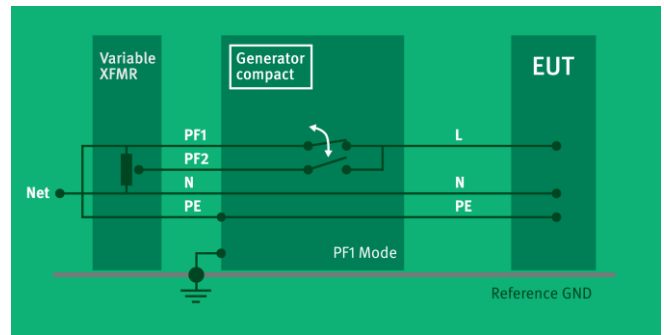

Setup for PF2 mode

The generator is connected as follow:

PF1: Switch is open during the test

PF2: EUT supply voltage from the variable XFMR during the test.

The variable XFMR starts at the default voltage and reduce to the settled voltage. Start the voltage interruptions with PF2. After the last interruption the variable XFMR returns to the default voltage.

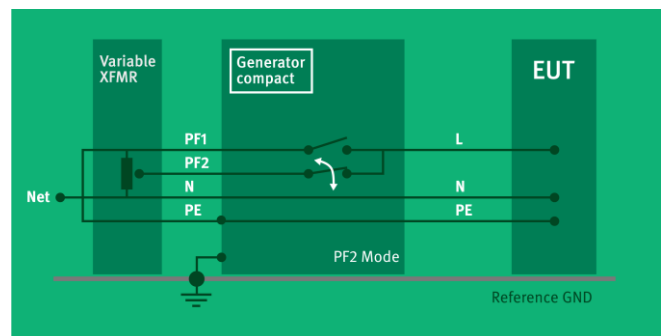

12.2. Operation

Dips Module for voltage Dips and short interruptions.

The menu offers different test routines for pulsed magnetic field testing.

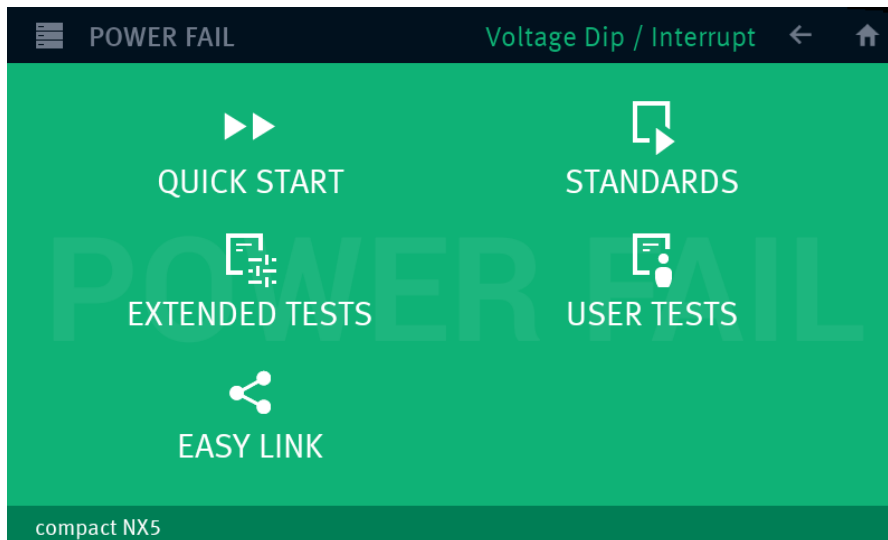

Main Menu Power Fail for voltage dips and interrupt tests

The Power Fail menu offers different test routines for voltage dips and interrupt testing.

Quick Start

Easy and fast online-operation of the equipment for voltage DIPS and power interruption tests.

Standard

The operator can select between various preprogrammed test routines as required in different standards. The operator can select the standard routine for 50/60Hz, depend of the measured frequency, testing as per IEC 61000-4-11.

Extended test

The operator can select between various preprogrammed test routines which helps to accelerate testing and which are very helpful especially during design.

User test routines

The user defined library where all created power fail tests are stored.

Easy Link

Link files library created during the actual session. The user can easy save a test into the Easy Link library. After switch off the Equipment all Easy Link tests are deleted. Use "SAVE AS USER TEST" for definitive save the test.

12.2.1. Quick Start

Easy and very fast operation of all standard functions of the equipment. The latest simulator settings are stored automatically and will be recalled when Quick Start is next selected.

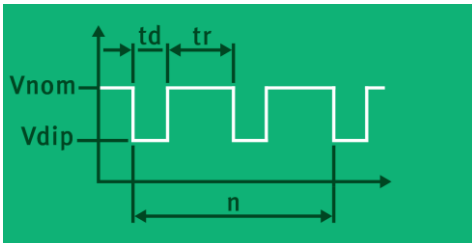

Explanations	
A	Phase angle
td	Duration of a single event
Rep	Repetition rate (time between two events)
CH	Channel select (PF1, PF2 or ΔV)
V2	Variable test voltage (controlled by 0-10 V analog voltage)
n	Number of events
tri	Trigger mode

The parameter to change can be selected by pressing a function key. The corresponding range will then be displayed.

12.2.1.1. Voltage DIPS

For testing voltage DIPS select:

Mode **ΔU**: During the test the internal switch toggle the supply voltage between PF1 and PF2

Vdip: Dip voltage [%Vnom] or [V]
td: Duration of the dip
tr: Repetition time between two dips [ms, s]
Sync: Synchronization with **phase angle A** [°]
n: Number of events

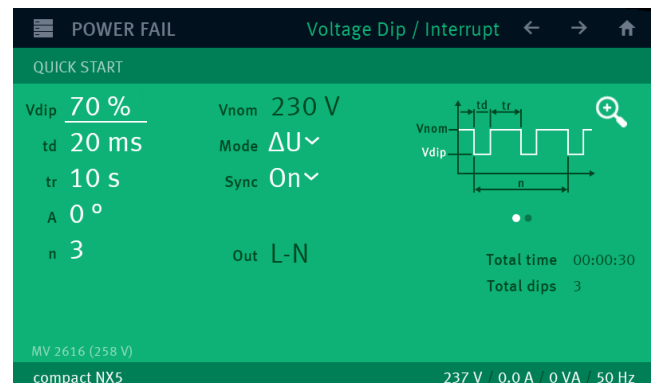

12.2.1.2. Voltage Interruption

For testing voltage DIPS select:

Mode **ΔPF1**: During the test the internal switch PF1 will switch ON and OFF during the test

td: Duration of the interruption
tr: Repetition time between two interruption
Sync: Synchronization with **phase angle A** [°]
n: Number of events

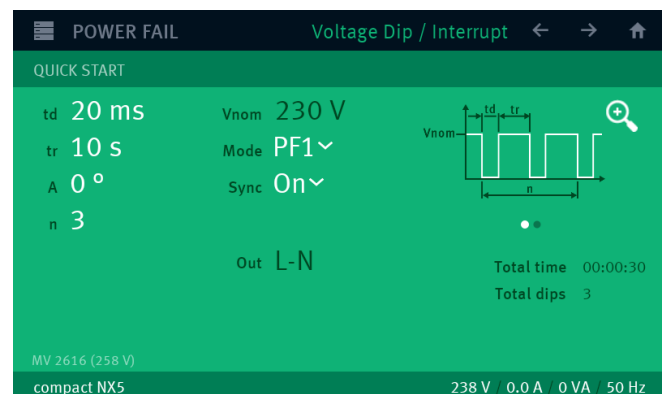

12.2.2. Standard Test Routines

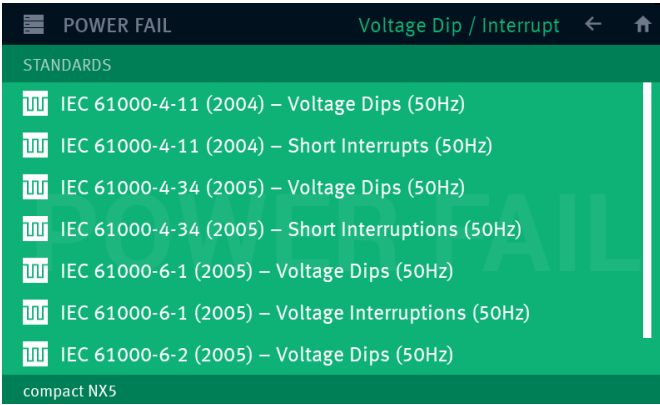

12.2.2.1. IEC 61000-4-11 (AC power supply mains)

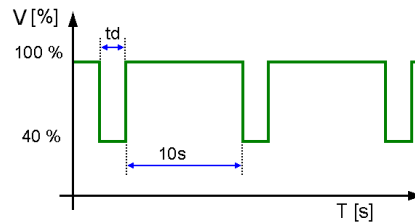
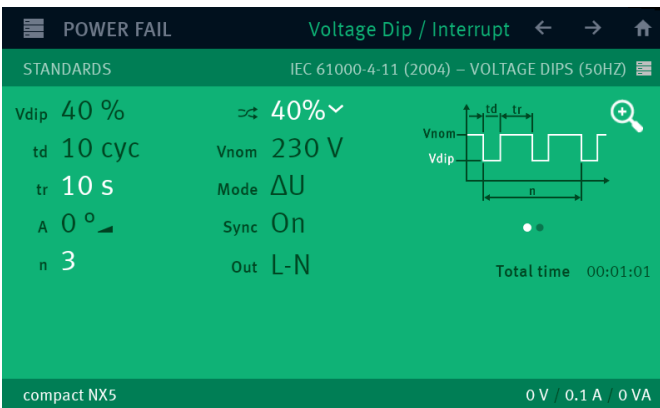

As long as the external transformer variac NX1-260-16 is used, controlled by an analogue 0-10V control voltage, the test is conducted automatically. If this option is not available the manual test routine shall be used.

Using a tapped transformer V 4780, the user must connect the PF2 UCS input with the correct plug at the V4780. At 0% selection the PF2 input must be connected to the neutral (0V) plug.

Short interruptions

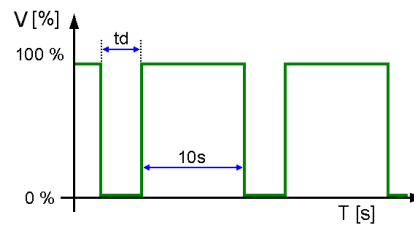
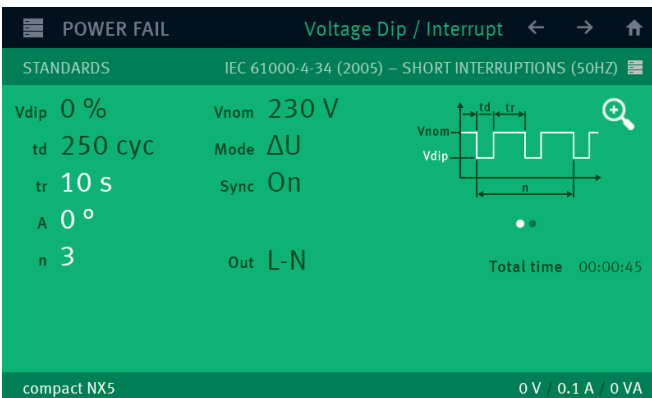

12.2.3. Extended Tests

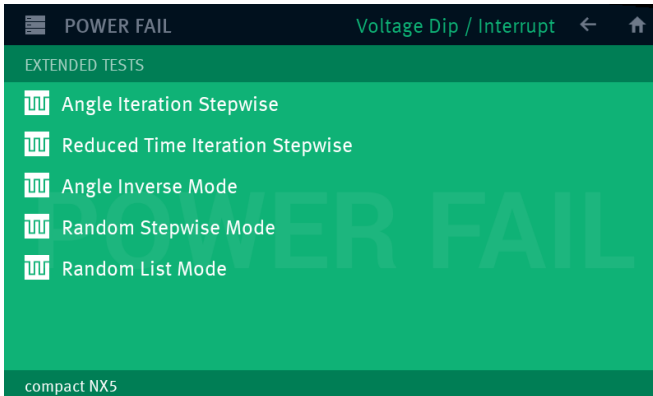

Angle iteration stepwise

After n events the phase angle related to which the events are released will change from $A1$ to $A2$ by steps of ΔA until $A2$ is reached. The same parameters as under Quick Start can be selected.

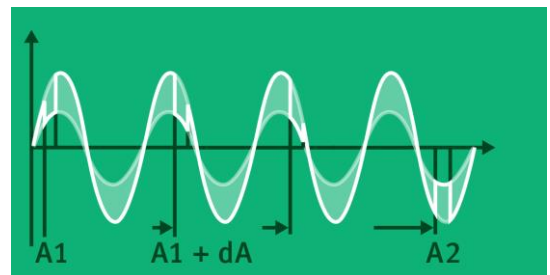

Reduced Time Iteration Stepwise

After n events the duration of a single event will change from $td1$ to $td2$ by steps of Δtd until $td2$ is reached. The same parameters as under Quick Start can be selected.

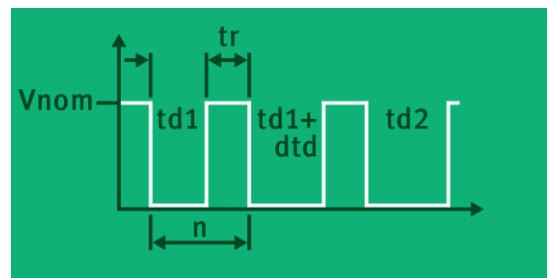

Angle Inverse mode

The inverse mode can simulate a phase control circuit, switching power (voltage) on/off at a certain phase angle. The phase angle is selectable in the range of $0-180^\circ$. The voltage will be switched on/off in each half-wave. Inverse is only working in ΔU mode.

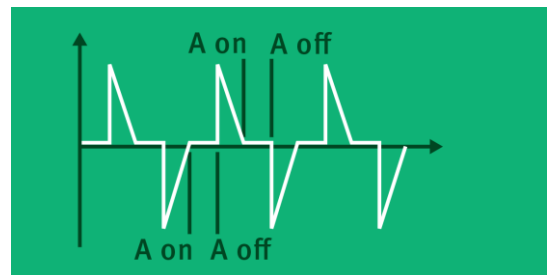

12.3. Voltage Variation

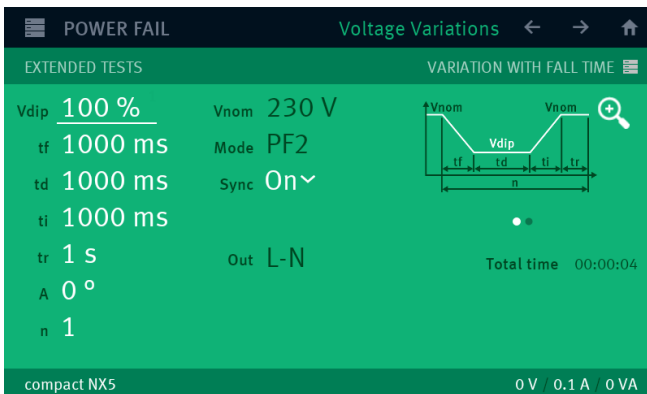
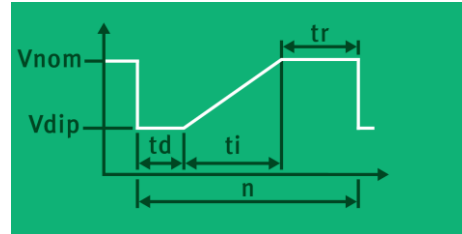
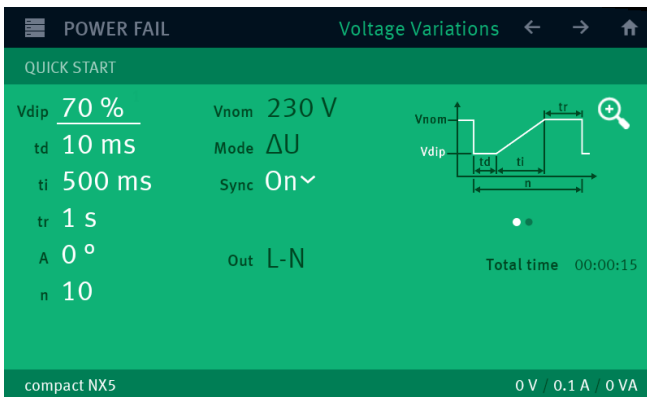

Voltage variation as per IEC 61000-4-11 (2004)
 An external power source or motor driven variac is controlled by a 0-10V control signal. The operator can select the time per voltage level, the ramp up and ramp down of the voltage change and the voltage levels itself.

12.4. Power Fail Menu

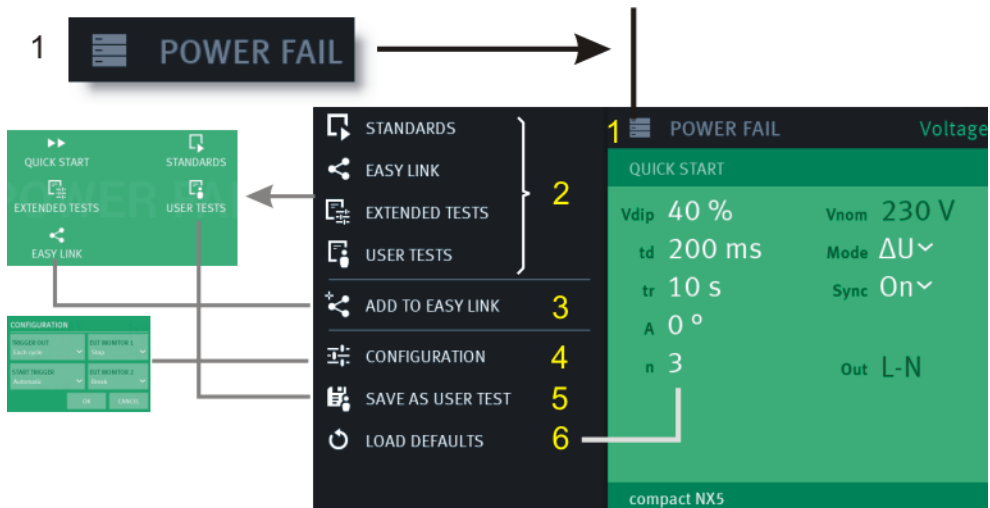

Burst Menu

- 1 Button for open and close the Power Fail Menu
- 2 Change to other power Fail test routines. The last used test in this routine will be loaded.
 - Quick Start
 - Standards
 - Extended Tests
 - User Tests
 - Easy Test
- 3 Add the actual test to Easy Link library
- 4 Trigger and Monitor setting for Power Fail tests. (Each phenomenon has an individual configuration)
- 5 Add the actual test to User Test library
- 6 Load the default parameters for the Quick Start test (factory setting)

12.5. The Power Fail Test

12.5.1. Test routines termination

The test routine for power fail starts with an event with the duration (t_d), followed by a repetition time (t_r). For operating, the compact NX generator has the following handling for the test routine

Single Test routine	
Test routine in a testlink implemented	

Δ

12.5.2. Operating

The power fail simulator operates in the following mode:

PF1: The voltage supply at channel PF1 will be interrupted for the preselected time $T1$.

PF2: The voltage supply at channel PF2 will be interrupted for the preselected time $T1$.

ΔU: Channels PF1 and PF2 are supplied with different voltages; e.g. channel PF1 with nominal voltage, channel PF2 with 15% under-voltage.

- channel PF1 is switched off for the preselected time $T1$.

- channel PF2 is switched on for $T1$.

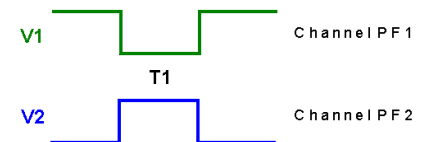

LED

Two LED's mounted on the front panel show if a channels is active or not. The LED of an active channel is lighted. During mode ΔU the LED display switches from one channel to the other.



Voltage interference

In order to accelerate the test procedure the voltage interference may be generated repetitively. In the operating mode „AUTO“, the events are released at a preselected interval time.

Power switches

The power unit of the simulator consists of two electronic power switches $S1$ and $S2$. The two separated input channels PF1 and PF2 are connected to each other at the front panel of the simulator via $S1$ and $S2$.

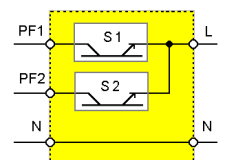

Input channels

The input channels PF1 and PF2 are located at the rear part of the equipment. Attention has to be given to the following:

1. The phase shall be connected correctly. When putting into operation check the lines with a phase tester or with the incorporated LED phase.
2. Phase must be set on L, neutral must be set on N.
3. This applies to both channels. If during installation phase and neutral is changed, the operator will cause a short-circuit at the input plug of the channel.
4. The neutral of both channels is connected internally and directly leads to the output.
5. The power switches can bear no more than a voltage of 350Veff.
6. If isolating transformers are used special care shall be taken to have both channels in phase. Otherwise too high voltages, in difference mode, may occur and destroy the internal protection devices (varistors).

12.6. Overcurrent

Power switches

The power switches are electronically protected against overload and short-circuits. The nominal current of the switches is 25 A.

Special protection requirements of the EUT must be separately assured by the user.

Inrush currents of ≤ 500 A are permitted. To avoid higher inrush currents of the EUT an electronic control limiting the inrush current is incorporated in the device.

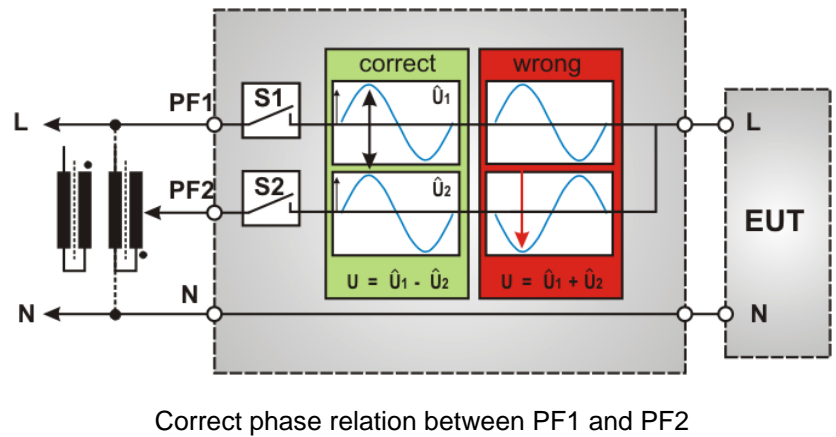

Over-voltage generated by connecting or disconnecting additional loads will be limited internally by varistors in parallel to the electronic switch.

Occurs an overcurrent during a test, The PF switches will switch off immediately and the display shows:



This error message appears after a short circuit at the EUT output plugs. This current can be up to 700A during few μ s and will be detect from the overcurrent detection.

For overcurrent handling proceed as follow:

1. **Disconnect the short circuit** and make sure to remove the failure.
2. Press **OK**. This will switch on the PF switch again and returns the power to the EUT output.
3. Continue in the start menu with **START**.

12.7. The Power Fail Test

The generator type compact NX5 N5/N7 simulates the following interference :

- Voltage dips
- Voltage interruptions
- Voltage variations
- Inverse

12.7.1. Voltage Interruptions

Depending on the preselected test parameters at the front panel of the simulator the power supply for the EUT is interrupted for a certain time and at a certain phase angle (AC power supplies).

The power supply for the EUT is connected at the rear part of the simulator to channel PF1.

The power supply may be taken directly from the mains power supply or from a separate voltage source. Mostly used for this tests are motor driven variacs

Power fail tests are normally carried out at a nominal voltage and at maximum tolerance under-voltage.

The nominal voltage may be connected to PF1 and the reduced dip voltage to PF2.

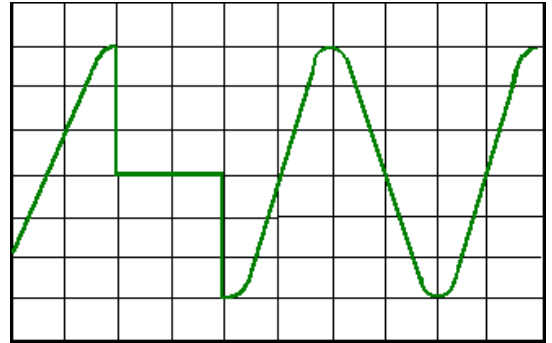

The power fail test may be carried out in various operating modes:

High impedance interruptions

With ΔU mode the EUT supply is interrupted by the electronic switch. The PF2 input is not connected. The EUT must discharge itself internally.

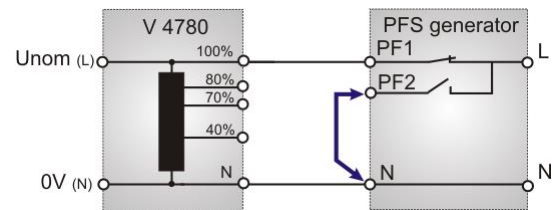

Low impedance interruptions

The EUT supply is connected to PF1. The channel PF2 is short-circuited (L-N). The EUT supply is disconnected by the electronic switch of PF1 and the EUT will be discharged into a low impedance via the electronic switch of PF2

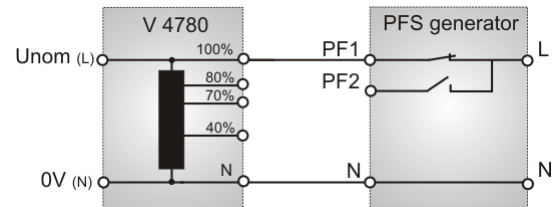

12.7.2. Voltage dips, voltage variations

Depending on the preselected test parameters, the test voltage is changed to a higher or to a lower value for a certain duration and at a certain phase angle.

Voltage variations are normally related to the nominal value of the supply voltage. Therefore two different variacs shall be connected at the rear side of the simulator.

- PF1 → Nominal voltage
- PF2 → Under- / overvoltage

The operation mode ΔU shall be preselected. The voltage variation is realized by switching the power supply from channel PF1 to channel PF2.

If a motor driven variac is available, it is also possible to drive the source by an analogue voltage 0 - 10V. This control voltage is available at the coaxial output at the rear part of the simulator

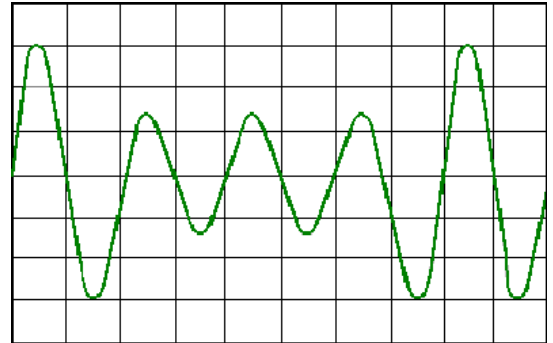

The control voltage is to be set via the operator menu or the interfaces of the Power Fail. A complete user software to drive ramps and functions is also available

12.8. DC Power networks

Basically there is no difference in the operation of the equipment between AC and DC power supplies. The only point the user should take care of are the grounding conditions.

The voltmeter, the "MONITOR" output and the LED are related to protective earth or to the simulator's chassis, respectively. Therefore these instruments can be used to check line or neutral and to measure at the output CRO V while the test procedure is running.

It results for the DC power supply operation:

- If it is possible to ground the "MINUS" pole of the DC supply, from the EUT point of view, the blue output plug (minus) should be connected to the green/yellow plug.
 - By this way the power supply source connected at the rear side of the simulator might be grounded.
- All measuring facilities are available if
- it is not possible to ground the "MINUS" pole and therefore the voltmeter cannot indicate the DC voltage.
 - the phase indication led at the EUT supply input are not glowing
 - there is no signal at the "CRO V" output.

12.9. Test setup and accessories

12.9.1. Transformer type V4780

The transformer shall be used to generate under-voltages in ac power supply systems. According to the IEC 61000-4-11 and the EN 50081-2 voltage dips shall be generated as shown in fig. below. Different test levels are recommended

12.9.1.1. Voltage interruptions (DIPS)

Voltage interruptions will cause a reduction of the power supply voltage for a certain period of time. Three different test levels are required:

- Voltage dip by 100% to 0% of the nominal voltage for 10ms or. ½ period
- Voltage dip by 100% to 0% of the nominal voltage for 20ms respectively 1 period
- Voltage dip by 60% to 40% of the nominal voltage for 200ms respectively 10 periods
- Voltage dip by 30% to 70% of the nominal voltage for 500ms respectively 25 periods
- Voltage dip by 20% to 80% of the nominal voltage for 5000ms respectively 250 periods

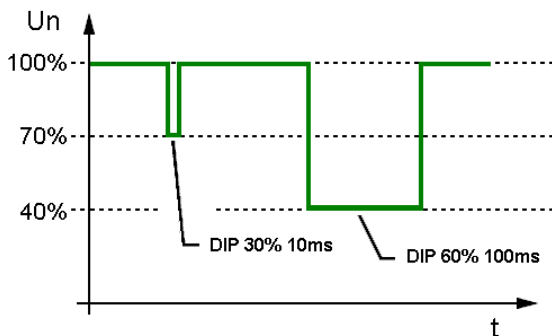

Standard voltage dips



V 4780 S2 with automatic tap control

The transformer is an accessory to the following devices
- compact NX5 Nx,

12.9.1.2. Device models V 4780

V4780	250 V 16 A, manual control	
V4780 S1	250 V 16 A manual control	additional tap at 120%
V4780 S2	250 V 16 A, automatic control	
V4780 S3	250 V 32 A, manual control	

12.9.1.3. Control V4780 S2

The V4780 S2 is controlled through the analogue input (0...10Vdc). The control circuit switches to the related tap, 40%, 70% or 80%, proportional to the applied dc reference voltage (0...10V dc) to the output PF2.

Is the reference dc voltage out of the tolerance ($\pm 0.25V$), the control will not switch to any tap to the PF2 output.

Operating with ramps the control circuit will not select a tap, if the ramp (0-100%) is shorter than approx. 4s. Programming longer ramps, each tap will switch on and off when the reference is in the valid range.

Voltage taps	DC reference voltage
80% of Vnom	8.00V \pm 0.25V
70%	7.00V \pm 0.25V
40%	4.00V \pm 0.25V

Settings on compact NX5 for V4780 S2

The compact NX5 must be matched to the 0-10V input of the V4780. Therefore a **V4780 must be configured as a motor variac**. For V and Vn must set to the same value which is the value of the voltage of your power supply.

Setup:

Settings	EUT / SUPPLY			Equipment tapped transformer
	V	Vnom	Path	Maximum voltage
Example for 230V mains	230 V	230 V	PF1	230 V

12.9.1.4. Technical Data V 4780 models

Design Tapped auto-transformer with 40%, 70%, 80%, 100 % output voltage

Input:

Voltage U_{in} : max. 250 V
 Frequency 50/60Hz
 Tap selection manually (V4780) banana plugs for 40%, 70%, 80%
 Remote control 0.10V dc (V4780 S2) for 40%, 70%, 80%

Output:

Voltage tap [% U_{nom}]
 120 % (V4780 S1)
 100 %
 80 %
 70 %
 40 %

V 4780, S1, S2

V 4780 S3

Current I_{max} .	16 A	32 A
Power	4.1 kVA	8.2 kVA
Fuse	2x 16 A	2x 35 A

Weights and measures

Dimensions	95 x 170 x 190 mm (H x B x T)	200 x 170 x 190 mm (H x B x T)
Weights	ca. 7 kg	ca. 14 kg
Temp Ambiance	10°C - 35°C	10°C - 35°C

12.9.1.5. Setup V4780

The output voltages are available at safety banana plugs. For safety reasons the related safety cables shall be used.

The power supply input is realized with a power connector for L, N and PE. The voltage shall be 100% of the nominal voltage V_n .

Connection V 4780 / V 4780 S2

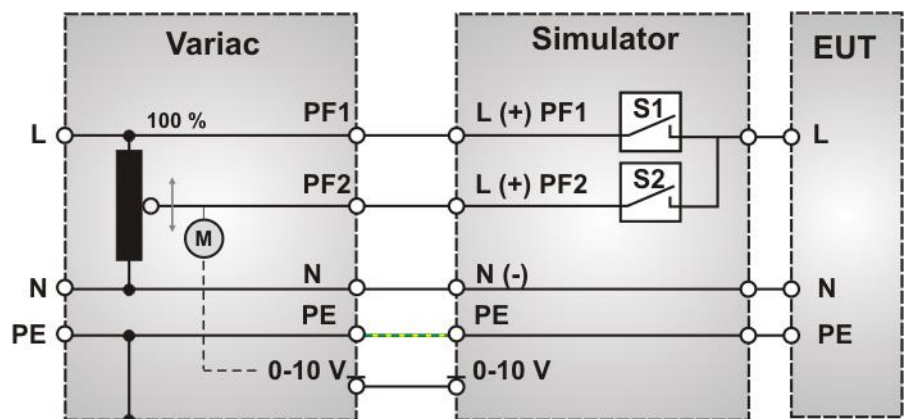

Connection V 4780 S1

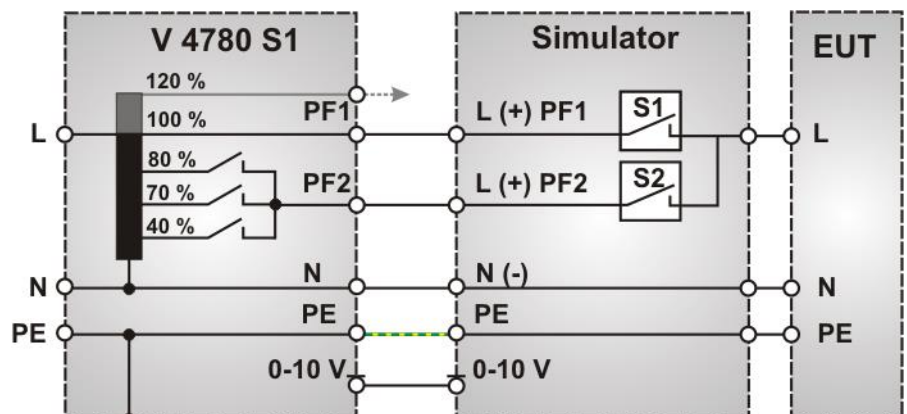

12.9.2. Variable Transformer variac NX1-260-16

The motor variac can be used to simulate power supply failures as under-voltages, voltage interruptions and voltage variations. The basic standard IEC 61000-4-11 and the generic standard EN 61000-6-2 are specifying these phenomena.

12.9.2.1. Voltage dips / interruptions

Voltage interruptions will cause a reduction of the power supply voltage for a certain period of time. Three different test levels are required:

- Voltage dip by 100% to 0% of the nominal voltage for 10 ms or. 0.5 cycle
- Voltage dip by 100% to 0% of the nominal voltage for 20 ms respectively 1 period
- Voltage dip by 60% to 40% of the nominal voltage for 200 ms respectively 10 periods
- Voltage dip by 30% to 40% of the nominal voltage for 500 ms respectively 25 periods
- Voltage dip by 20% to 80% of the nominal voltage for 5000 ms respectively 250 periods

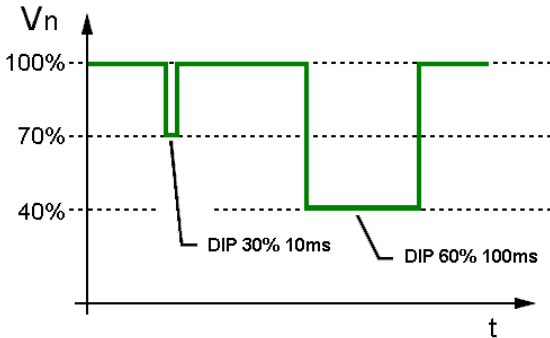

Standard voltage dips

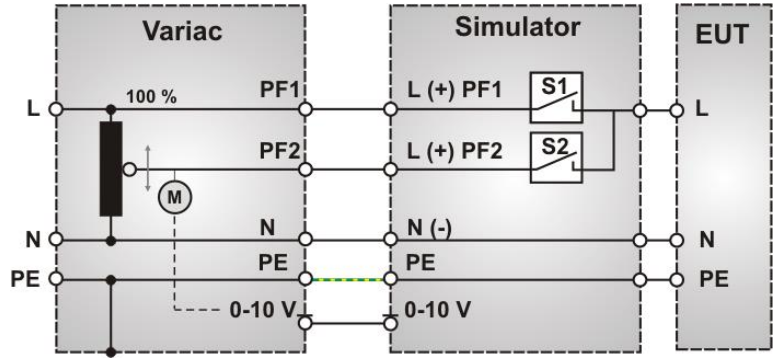

Connection diagram variac NX1-260-16

The unit has to be connected at the rear part of the equipment. For connection safety labor cables shall be used.

12.9.2.2. Voltage variation

Additionally it is possible to drive certain functions of variation, which also are required in IEC 61000-4-11. These functions can easily be programmed within the simulators itself or within the related windows software ISMIEC

V2	Test level [%U1]:	40%, 0%
tf	Time for decreasing voltage [sec]	2 ± 20%
t1	Time at retained voltage [sec]	1 ± 20%
tr	Time for increasing [sec]	2 ± 20%

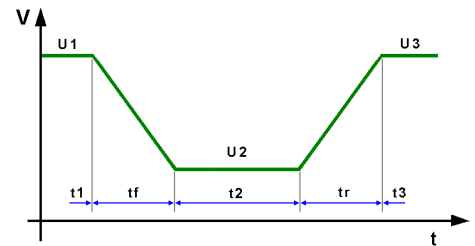

For new FDIS IEC 61000-4-11 (2004) use a new procedure for voltage variation, who simulate a voltage dip during a motor start.

The motor variac will be set previously to the voltage V2. The switch to PF2 happens in the compact NX5. Then the motor variac increase the voltage controlled by the UCS. After ti the voltage change back to PF1

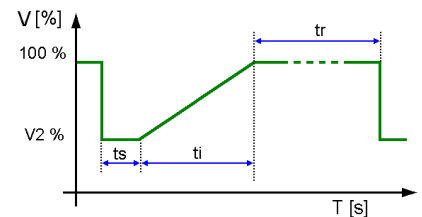

The speed of the voltage variation depends on the max. speed of the motorvariatic and the control setting of the integral action controller. The behavior can be influenced by the parameter Vnominal. Setting in the setup menu Setup / F5 Voltage setting.

The user can optimize his setting for the test.

- Vn = Vmax of motorvariatic Red curve the voltage rising is too fast.
- Vn = 110% of Vnominal Green curve optimum setting
- Vn = Vnominal Blue curve the voltage regulation is too slow.

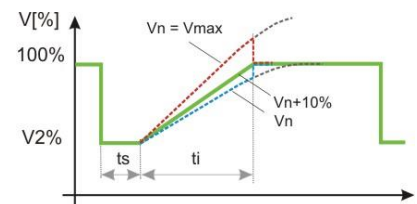

12.9.2.3. Technical data Motorvariac variac NX-1-260-16**Input:**

Voltage Vin: max. 250 V
 Frequency 50/60 Hz

Output

Voltage variable Vout: 0 – 260 V for channel PF2
 Voltage fix Vout: Vin for channel PF1
 Current max: 16 A
 Power 0 - 4.1 kVA

**Control**

Main switch On/Off for the output voltages
 Control voltage analogue 0 - 10V DC for 0-260V output voltage
 Time 0..100% < 2s

Dimensions and weight

Dimensions 19" 6HE 266x485x400mm (H x W x D)
 Weight app 27 kg
 Power supply 115/230 V
 Fuse 20 A (PF1), 16 A (PF2)
 Environment Tmax 40°C

13. Power frequency Magnetic Field as per IEC 61000-4-8

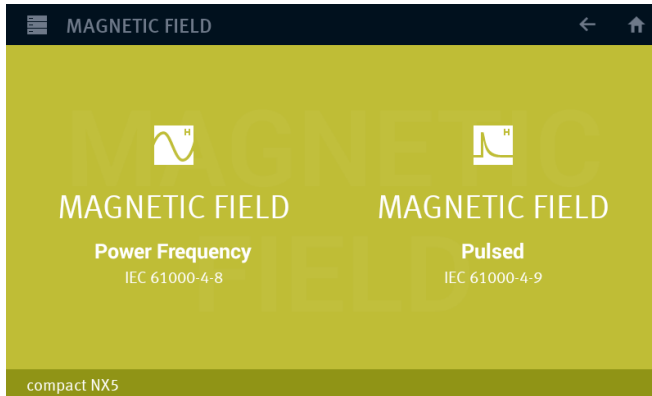

Main Menu Magnetic Field separated to “Power frequency” and “Pulsed”

Required Device settings to perform a power frequency magnetic field test

For perform a 50/60 Hz magnetic field test, the NX5 generator must be configured with the used hardware in the menu:

Menu / SETUP / Equipment

1. Variable transformer:

- variac NX1-260-16
- variac NX1-260-32

2. Magnetic current transformer

- MC 26100 H-field 75 to 1100 A/m
- MC 2630 (1 A range) H-field 1 to 9 A/m
- MC 2630 (30 A range) H-Field 9 to 75 A/m



Note: The MC 2630 has two ranges and therefore the NX generator list this current-transformer in the configuration for (1 A) and (30 A) range. Set the range switch of the MC 2630 to the correct position before start the test.

Menu / SETUP / EXTERNAL COUPLERS

3. Magnetic field antenna:

- MS 100N

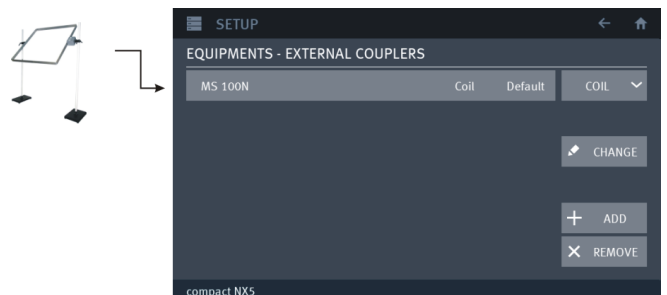

Set the used equipment to default status

13.1. Magnetic field as per IEC 61000-4-8

The menu offers different test routines for power frequency magnetic field testing.

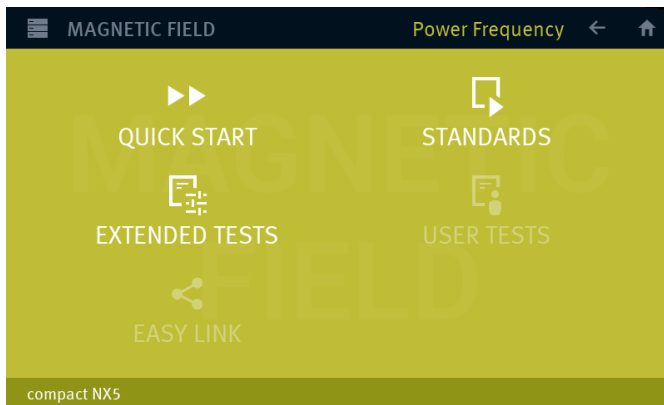

Main menu ac powered magnetic field

The Magnetic Field menu offers different test routines for pulsed magnetic testing.

Quick Start

Easy and fast online-operation with the phenomenon magnetic-field. In this menu the user can operate all test manually with online change the most parameters during a test.

Standard

The operator can select between various preprogrammed test routines as required in different standards

Extended Tests

The operator can select between various preprogrammed test routines which helps to accelerate testing and which are very helpful especially during design.

User test routines

The user defined library where all created magnetic field tests are stored.

Easy Link

Link files library created during the actual session. The user can easy save a test into the Easy Link library. After switch off the Equipment all Easy Link tests are deleted. Use "SAVE AS USER TEST" for definitive save the test.

Test setup



Warning

For magnetic field testing the power mains input at PF1 shall be disconnected.; 230 V/16 A.

The voltage V is adjusted with a variac as long as the required antenna current is available and the related H field is generated in the center of the magnetic field antenna.

The variac NX1-260-16 may be controlled automatically via the test generator. Any equivalent variac available in the lab can be used to control the current manually. Please take care that the variac has a sufficient current capability.

For more detailed information the operator can require an additional manual especially for magnetic field testing. This manual is part of the delivery of magnetic field testing accessories.

Test setup with MC 2630 for H-Fields up to 30A/m

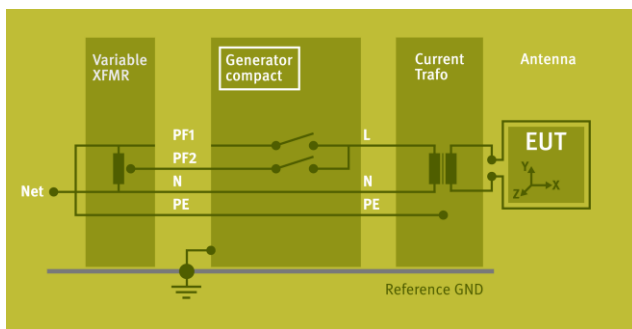

Schematics

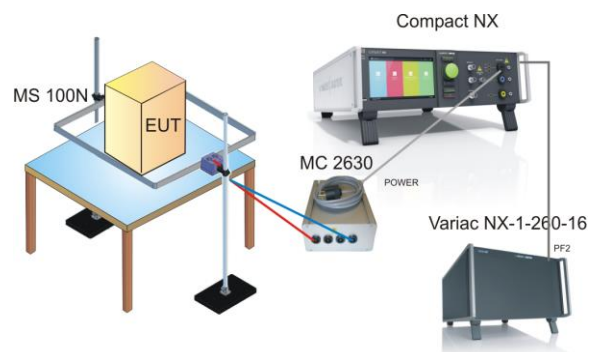

Test setup

Schematics and Test setup with compact NX5, variac NX1-260-16, MC 2630 and MS 100N

Option for required magnetic field tests as per IEC 61000-4-8

- External variable motor transformer **variac NX1-260-16**
- External Magnetic field antenna **MS 100N**
- External current transformer **MC 2630** to test 1, 3, 10 and 30A/m levels

Test setup with MC 26100 for H-Fields up to 1000A/m

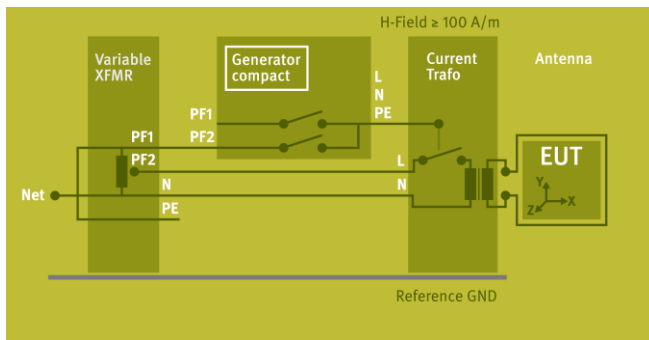

Schematics

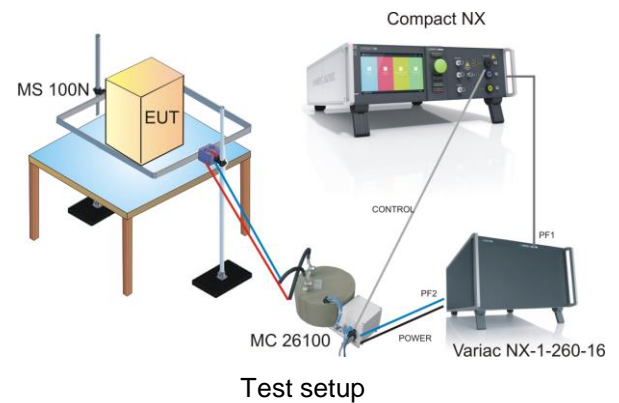

Test setup

Schematics and Test setup with compact NX5, variac NX1-260-16, MC 26100 and MS 100N

Option for required magnetic field tests as per IEC 61000-4-8

- External variable motor transformer **variac NX1-260-16**
- External Magnetic field antenna **MS 100N**
- External current transformer **MC 26100** to test 100 to 1000A/m levels

14. Telecom Surge Immunity as per IEC 61000-4-5

Surge Module 10/700 μ s – 8/20 μ s



WARNING

The internal coupling network is designed for **mains frequency 50 Hz / 60 Hz**.

When L – N coupling is selected an **additional current of approx. 1.5 A** flows, caused by the 18 μ F coupling capacitor and the pulse forming network. A similar current appears during the couplings to PE.

Tests with 400 Hz mains frequency **destroy the coupling network**. An external coupling network is recommended with inductors and capacitors matched to the 400 Hz mains frequency.

14.1. Operation

The Surge menu offers different test routines for burst testing.

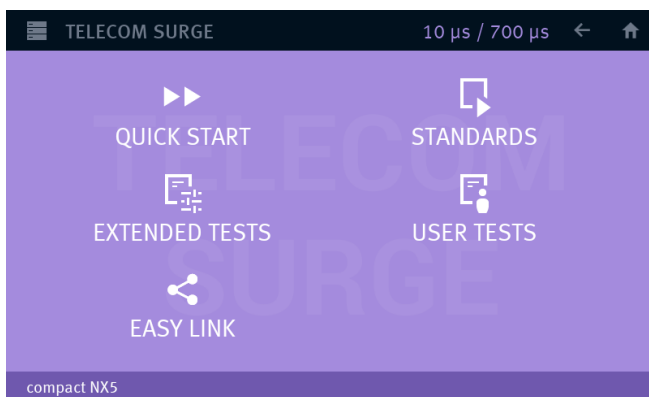

Main Menu Telecom Surge

The Surge menu offers different test routines for surge testing.

Quick Start

Easy and fast online-operation with the phenomenon Telecom Surge. In this menu the user can operate all surge test manually with online change the most parameters during a test.

Standard

The operator can select between various preprogrammed test routines as required in different standards
The standard library includes IEC, ITU and ETSI standards

Extended Tests

The operator can select between various preprogrammed test routines which helps to accelerate testing and which are very helpful especially during design.

User test routines

The user defined library where all created Surge tests are stored.

Easy Link

Link files library created during the actual session. The user can easy save a test into the Easy Link library. After switch off the Equipment all Easy Link tests are deleted. Use "SAVE AS USER TEST" for definitive save the test.

14.1.1. Quick Start

Easy and very fast operation of all standard functions of the equipment. The latest simulator settings are stored automatically and will be recalled when Quick Start is next selected.

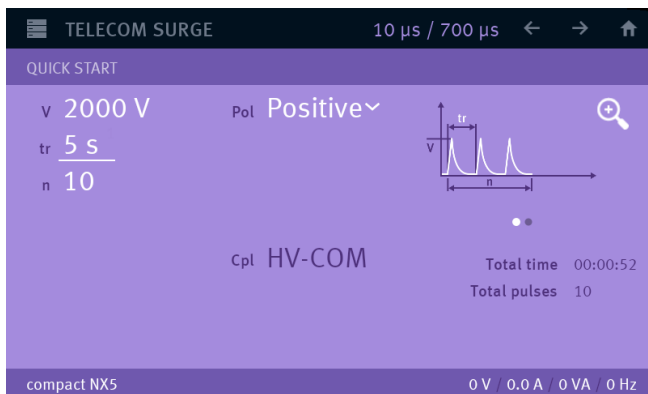

Quick Start Menu

While a test is running the user can select parameters. The selected parameter then can be changed online with the inc/dec knob.

14.1.2. Standard test Routine

The user can select preprogrammed standard test routines.

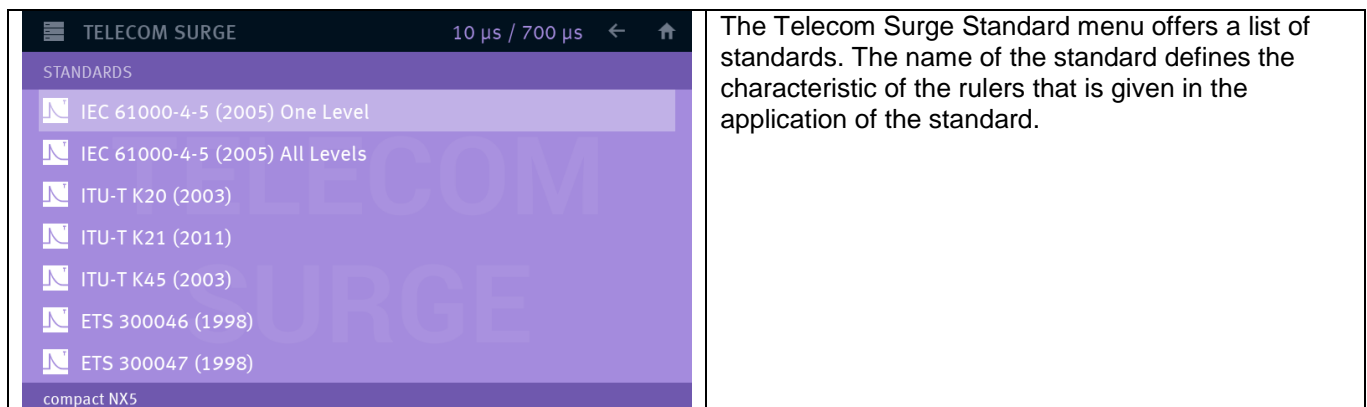

The Telecom Surge Standard menu offers a list of standards. The name of the standard defines the characteristic of the rulers that is given in the application of the standard.

The standard name has the character: **[Standard Family], [Standard number], [year]), [Application]**, where

Standard Family

IEC: *International Electrotechnical Commission*

ITU: *International Telecommunication Union*

ETS: *European Telecommunication Standard*

Standard Number

Indicates the official standard number defined in the standard.

Year

Year of standard publication. The year indicates the different standard publication. The year is used for follow the definitions specified in this publication.

Application

Specifies different applications or EUT characteristics

- One level: only one test level will be in this test. The user can select the test level (level 1 to 4)
- All levels: The test procedures start at the lowest level and increase to the level specified.

14.1.3. Extended Test Routines

The user can program, save and recall his own specific test routines. The next pages shows the selection of the functions.

The extended menu offers various useful tests for testing and development.

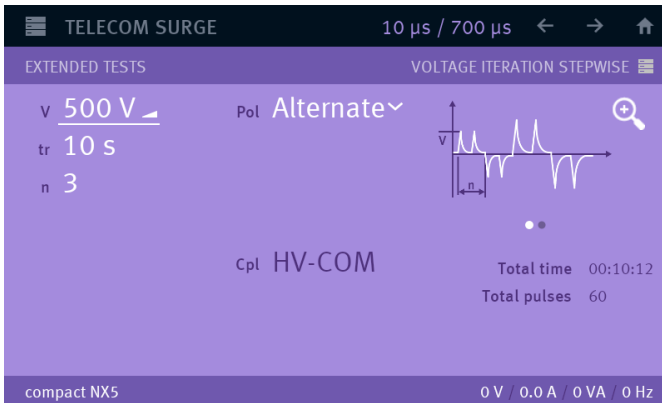

Extended Test

Change test level V after n pulses by ΔV

The test voltage V is changed from V1 to V2 in steps of ΔV . After the preselected number pulses the test changes the polarity. Then the next level is changed by ΔV until V2 is reached. The repetition time tr will be increased automatically if the setting time is too short.

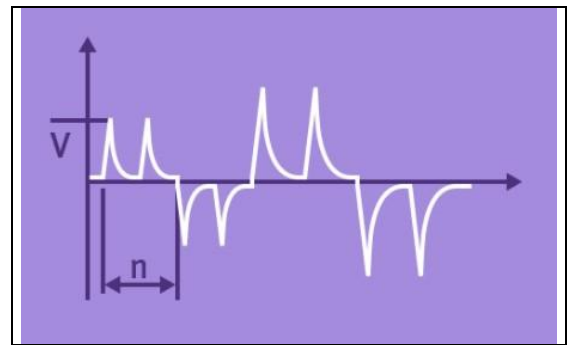

14.1.4. Generator Network for Telecom Surge

The figure below shows the elements and schematic of the Telecom Surge pulse circuit

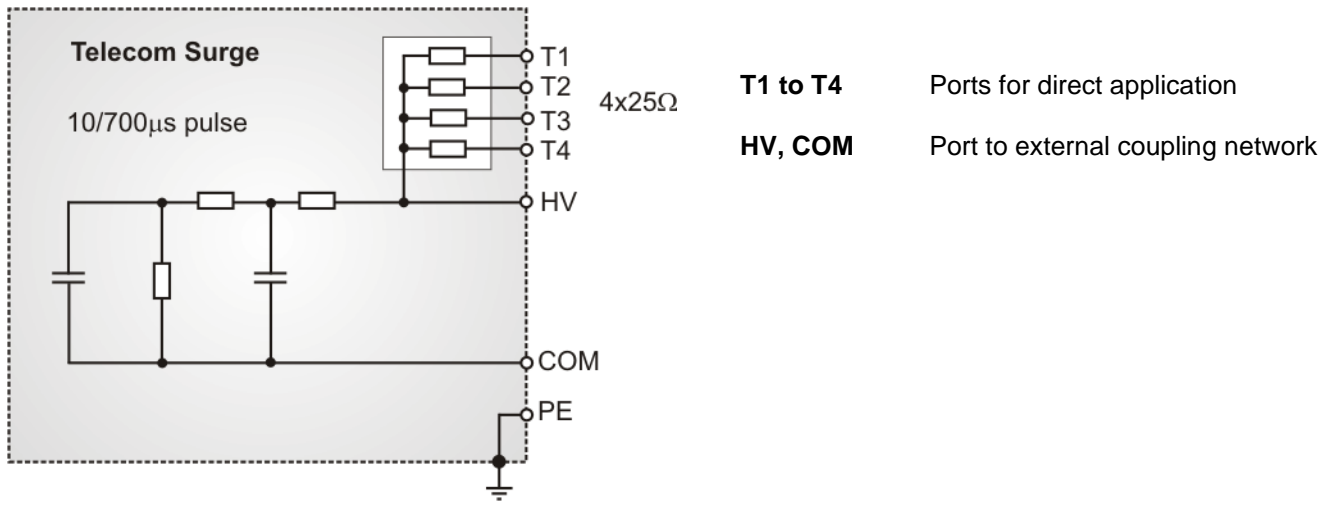

14.2. Telecom Surge Menu

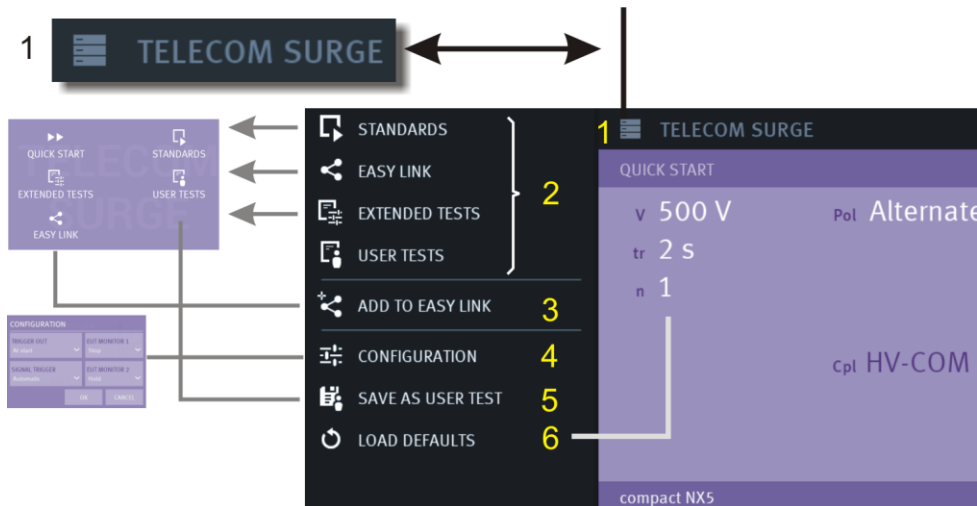

Telecom Surge Menu

- 1 Button for open and close the Telecom Surge Menu
- 2 Change to other Surge test routines. The last used test in this routine will be loaded.
 - Quick Start
 - Standards
 - Extended Tests
 - User Tests
 - Easy Test
- 3 Add the actual test to Easy Link library
- 4 Trigger and Monitor setting for Surge test. (Each phenomenon has an individual configuration)
- 5 Add the actual test to User Test library
- 6 Load the default parameters for the Quick Start test (factory setting)

14.3. Telecom Surge pulse settings

14.3.1. Configuration

In the configuration menu the user set the following parameters:

- **Trigger out signal** at the BNC plug on generator front side
- **Start trigger** for the impulse or event on the BNC Ext. Trigger plug on rear side or blinking Start button
- Behavior of the **EUT Monitor 1** and **EUT Monitor 2** on BNC plug on rear side

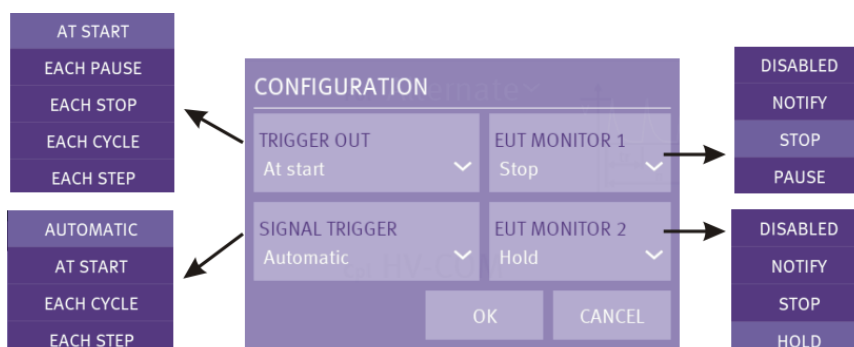

14.3.1.1. Trigger OUT

The trigger out signal is a programmable 5V edge signal located at the front side BNC Trigger plug. This signal is for trigger other devices like oscilloscopes or other devices.

The generator offers the following trigger out options:

- At **Start**
- Each **Pause**
- Each **Stop**
- Each **Pulse** every surge impulse release
- Each **Step** for tests with iteration

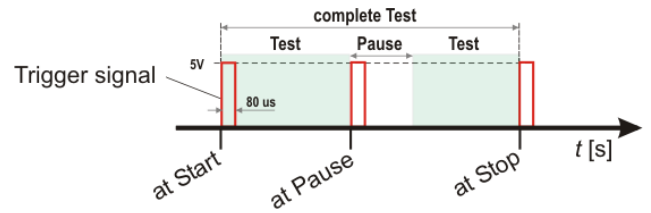

Iterations

For Iteration tests the parameters changes after each step as shown in the figure below. Depends of the order and setting the following parameters can change:

- Polarity
- Voltage

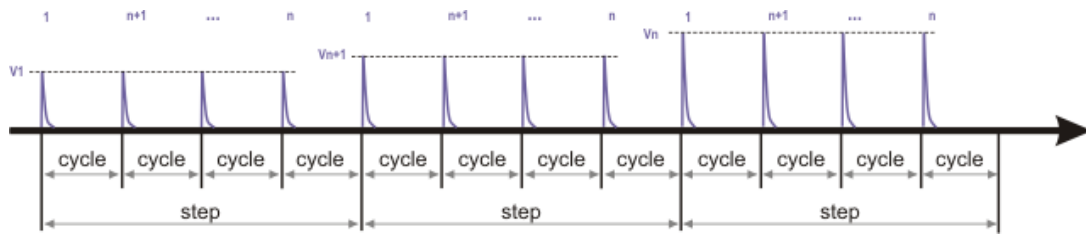

Example with voltage iteration that illustrate trigger out for cycle and step

14.3.1.2. Start Trigger

The Start Trigger occurs by pressing the blinking **START / PAUSE** button or with an external trigger positive slope signal at the rear side BNC **Ext. Trigger** plug.

The start trigger offers the following status:

- **Automatic**
- At **Start** (starts after the trigger)
- Each **pulse** (same as trigger out)
- Each **step** (same as trigger out)

If the start trigger is not set to Automatic, the trigger indicates with “**Waiting for trigger**” the recommended trigger signal.

The waiting time for a trigger signal is endless if no trigger timeout is enabled.

External trigger timeout

This function stops the test after the defined timeout time and indicates the message, “**Error trigger unit timeout**”.

For enable the function External trigger timeout select from the Home screen:

Menu / Setup / General / Process & sync

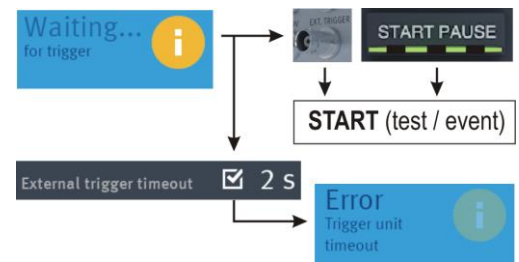

Start Trigger flowchart example from burst

15. Report

General

The NX application software generates during each test an internal log-file with all parameter settings and all actions during the test. This log file will be used for generate the report after the test. After the test following procedures are possible:

- The program starts to generates the report when “generate Report” is enabled.
- The user can manual generate the report when “generate Report” is disabled
- The user can save the log-file

15.1. Block diagram for report generation

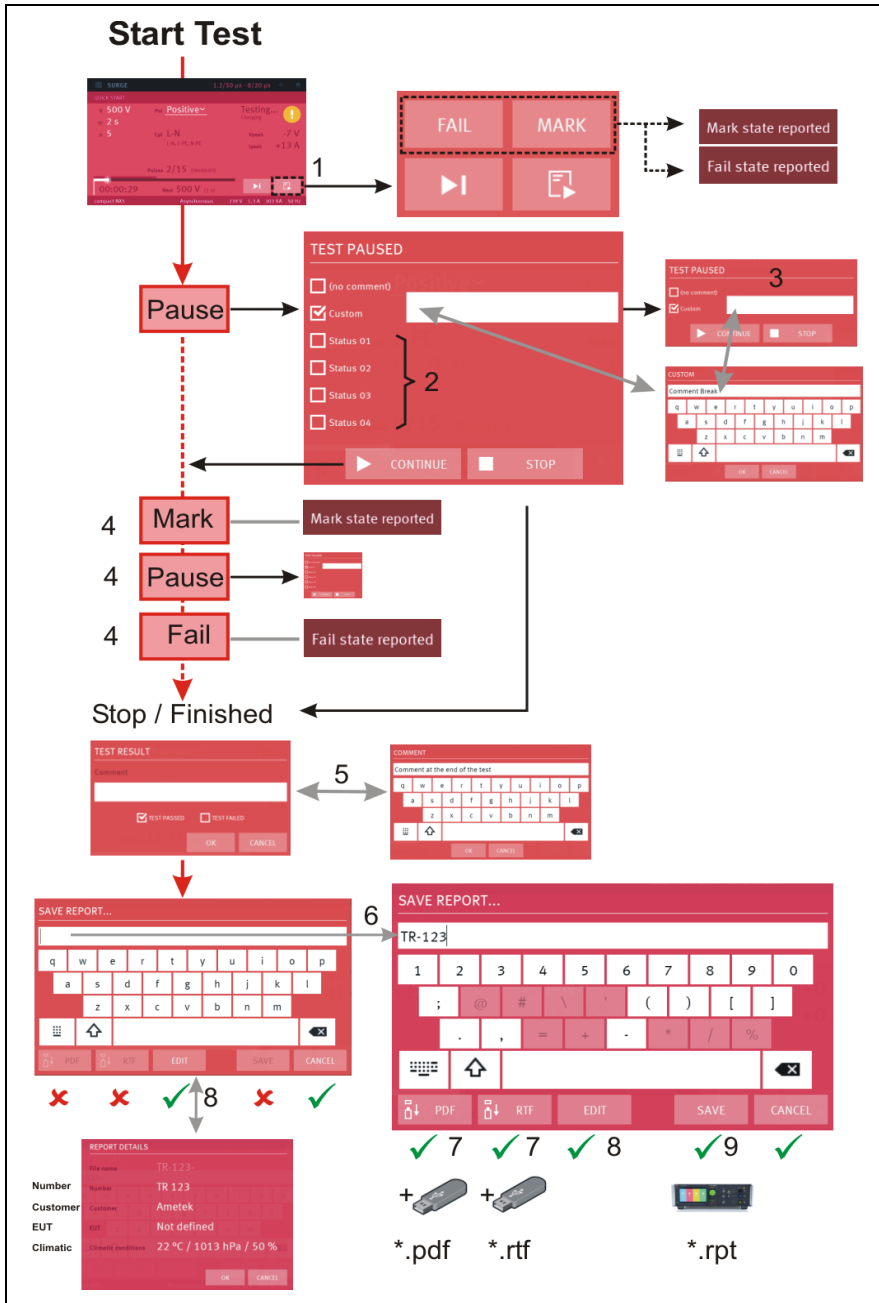

- 1 Press Report sign for enable report function MARK and FAIL
- 2 Status text (predefined) appears when messages are defined in menu Setup Report
- 3 Enter comment if required
- 4 Press **MARK**, **PAUSE** or **FAIL** for set a marker or comment
- 5 Enter a comment or/and Pass/Fail marker
- 6 The predefined Filename appears (if selected). Add individual letters for complete the filename.
Note: The Save buttons are disabled as long no filename is entered.
- 7 Save as *.pdf or *.rtf file to the USB memory stick.
Note: The USB memory stick must be connected to the NX-device.
- 8 Edit window for Test report number, customer, EUT name and climatic conditions
- 9 Save to internal SD card as *.rpt file
Note: If no SD card is present the file is saved on a USB memory stick. A message will indicate the missing SD card.

15.1.1. Save a report after the test

There is a possibility to save a report after the test, even when the user did not activate “generate report at test end”.



A report can be saved until the user press **BACK**. After this action the report information is lost

15.2. Report setting

The detailed report setting description is in chapter 4.3.6.7. Below you see the overview about the report configuration

Setup / General / Report. Below you see the

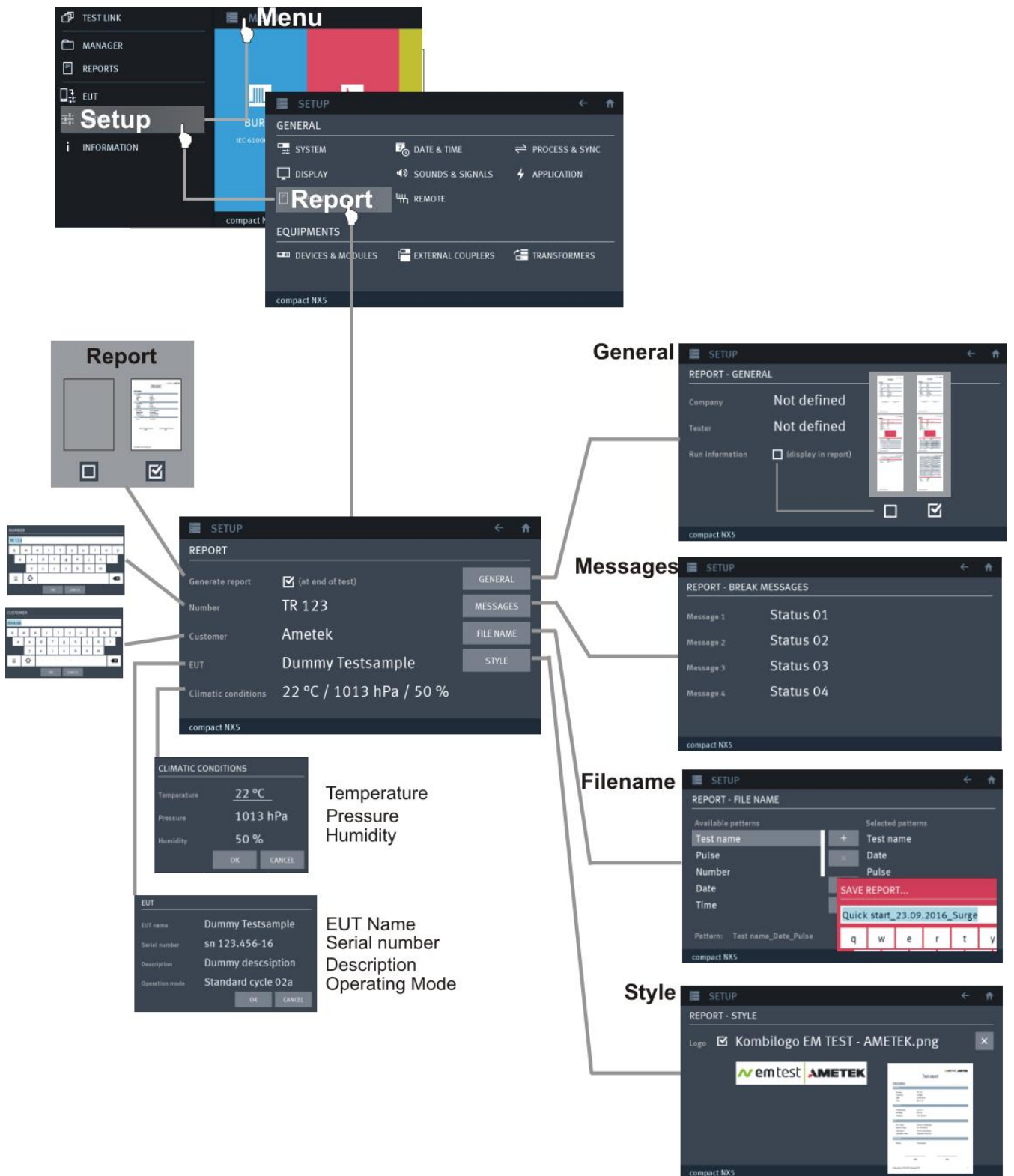

15.3. Report Export

The detailed report setting description is in chapter 4.3.6.7. Setup / General / Report. Below you see the overview about the report configuration

Setup / General / Report. Below you see the

The screenshot illustrates the 'Report' configuration in the compact NX5 software. The main interface shows a 'Menu' with options for BURST (IEC 61000-4-4) and SURGE (IEC 61000-4-5). Below this, the 'REPORTS' section displays a list of generated reports with columns for file name and size. A dropdown menu allows filtering by 'ALL', 'RPT', 'LOG', 'BY NAME', or 'BY DATE'. Action buttons for 'EDIT' and 'REMOVE' are visible. A 'REMOVE FILE' dialog box asks for confirmation to delete a file, noting that the action is irreversible. Callouts on the left show export options: 'EXPORT AS RPT', 'EXPORT AS PDF', 'EXPORT AS RTF', and 'EXPORT RUN INFORMATION'. Three examples of report outputs are shown: 'Run info *.log' (a text-based log), 'Report as *.rpt' (a PDF report with graphs), and 'Report as *.dpf' (a PDF report with graphs). A 'REPORT DETAILS' window shows fields for file name, number (TR 123), customer (Ametek), EUT (Dummy Testsample), and climatic conditions (22 °C / 1013 hPa / 50 %). A detailed log view shows entries for 'Quick start', 'Surge', and 'param_changed' events with specific parameters like voltage, polarity, and cycle count.

Used file extensions

16. Appendix

16.1. Declaration of CE-Conformity

16.1.1. CE-Conformity compact NX5

Manufacturer : **EM TEST (Switzerland) GmbH**
 Address: Sternenhofstr. 15
 CH 4153 Reinach BL1
 Switzerland

declares, that under its sole responsibility, the product's listed below, including all their options, are in conformity with the applicable CE directives listed below using the relevant section of the following EC standards and other normative documents.

Product's name: Ultra compact generator
 Model Number(s) compact NX5
 Tapped transformer: V 4780, V 4780S1

Low Voltage Directive 2014/35/EU

Standard to which conformity is declared:

EN 61010-1:2011 Safety requirements for electrical equipment for measurement, control, and laboratory use.

EMC Directive 2014/30/EU

Standard(s) to which conformity is declared:

EN 61326-1:2013 Electrical equipment for measurement, control and laboratory use
 (Requirements for devices to use in industrial area.)

EN 61000-3-2:2014 Limits for harmonic current emissions

EN 61000-3-3:2013 Limitation of voltage changes, voltage fluctuations and flicker in public low-voltage supply systems.

The purpose of this instrument is the generation of defined interference signals for EMI immunity testing. Depending on the arrangement of the test rig, the configuration, the cabling and the properties of the EUT itself, a significant amount of electromagnetic radiation may result that could also affect other equipment and systems. The user himself or herself is ultimately responsible for the correct and controlled operation of the rig. In case of doubt, the tests should be carried out in a Faraday cage.

European representative
 AMETEK CTS Germany GmbH
 Lünenerstr. 211
 D 59174 Kamen
 Tel: +49 (0) 2307 / 26070-0
 Fax: +49 (0)2307 / 17050



Manufacturer
 EM TEST (Switzerland) GmbH
 Sternenhofstr. 15
 CH 4153 Reinach
 Tel: +41 61-7179191
 Fax: +41 61-7179199



By A. Gerstner
 General manager
 Place Kamen, Germany
 Date 20. December 2016

A. Burger
 Design and Research
 Reinach BL, Switzerland
 25. February 2016

16.1.2. CE-Conformity V4780

Manufacturer : **EM TEST (Switzerland) GmbH**
 Address: Sternenhofstr. 15
 CH 4153 Reinach BL1
 Switzerland

declares, that under is sole responsibility, the product's listed below, including all their options, are conformity with the applicable CE directives listed below using the relevant section of the following EC standards and other normative documents.

Product's name: Tapped transformer
 Model Number(s) V 4780, V 4780S1

Low Voltage Directive 2014/35/EU

Standard to which conformity is declared:

EN 61010-1:2011 Safety requirements for electrical equipment for measurement, control, and laboratory use.

EMC Directive 2014/30/EU

Standard(s) to which conformity is declared:

EN 61326-1:2013 Electrical equipment for measurement, control and laboratory use
 (Requirements for devices to use in industrial area.)

EN 61000-3-2:2014 Limits for harmonic current emissions

EN 61000-3-3:2013 Limitation of voltage changes, voltage fluctuations and flicker in public low-voltage supply systems.

European representative
 AMETEK CTS Germany GmbH
 Lünenerstr. 211
 D 59174 Kamen
 Tel: +49 (0) 2307 / 26070-0
 Fax: +49 (0)2307 / 17050



Manufacturer
 EM TEST (Switzerland) GmbH
 Sternenhofstr. 15
 CH 4153 Reinach
 Tel: +41 61-7179191
 Fax: +41 61-7179199



By A. Gerstner
 General manager
 Place Kamen, Germany
 Date 20. December 2016

A. Burger
 Design and Research
 Reinach BL, Switzerland
 25. February 2016

16.1.3. CE-Conformity V4780

Manufacturer : **EM TEST (Switzerland) GmbH**
 Address: Sternenhofstr. 15
 CH 4153 Reinach BL1
 Switzerland

declares, that under is sole responsibility, the product's listed below, including all their options, are conformity with the applicable CE directives listed below using the relevant section of the following EC standards and other normative documents.

Product's name: Tapped transformer
 Model Number(s) V 4780S1

Low Voltage Directive 2014/35/EU

Standard to which conformity is declared:

EN 61010-1:2011 Safety requirements for electrical equipment for measurement, control, and laboratory use.

EMC Directive 2014/30/EU

Standard(s) to which conformity is declared:

EN 61326-1:2013 Electrical equipment for measurement, control and laboratory use
 (Requirements for devices to use in industrial area.)

EN 61000-3-2:2014 Limits for harmonic current emissions

EN 61000-3-3:2013 Limitation of voltage changes, voltage fluctuations and flicker in public low-voltage supply systems.

European representative
 AMETEK CTS Germany GmbH
 Lünenerstr. 211
 D 59174 Kamen
 Tel: +49 (0) 2307 / 26070-0
 Fax: +49 (0)2307 / 17050



Manufacturer
 EM TEST (Switzerland) GmbH
 Sternenhofstr. 15
 CH 4153 Reinach
 Tel: +41 61-7179191
 Fax: +41 61-7179199



By A. Gerstner
 General manager
 Place Kamen, Germany
 Date 20. December 2016

A. Burger
 Design and Research
 Reinach BL, Switzerland
 25. February 2016

16.2. compact NX5 General Diagram

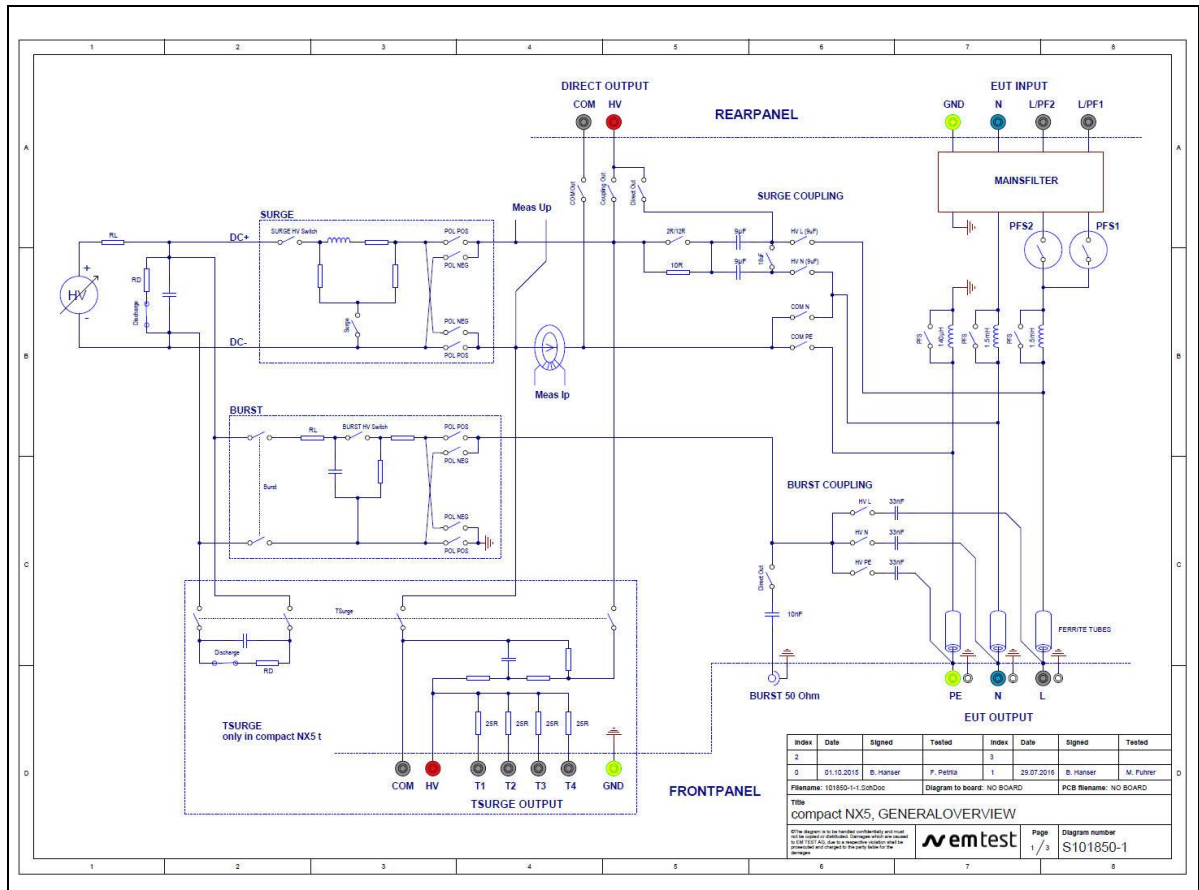

16.3. Main diagram control connection

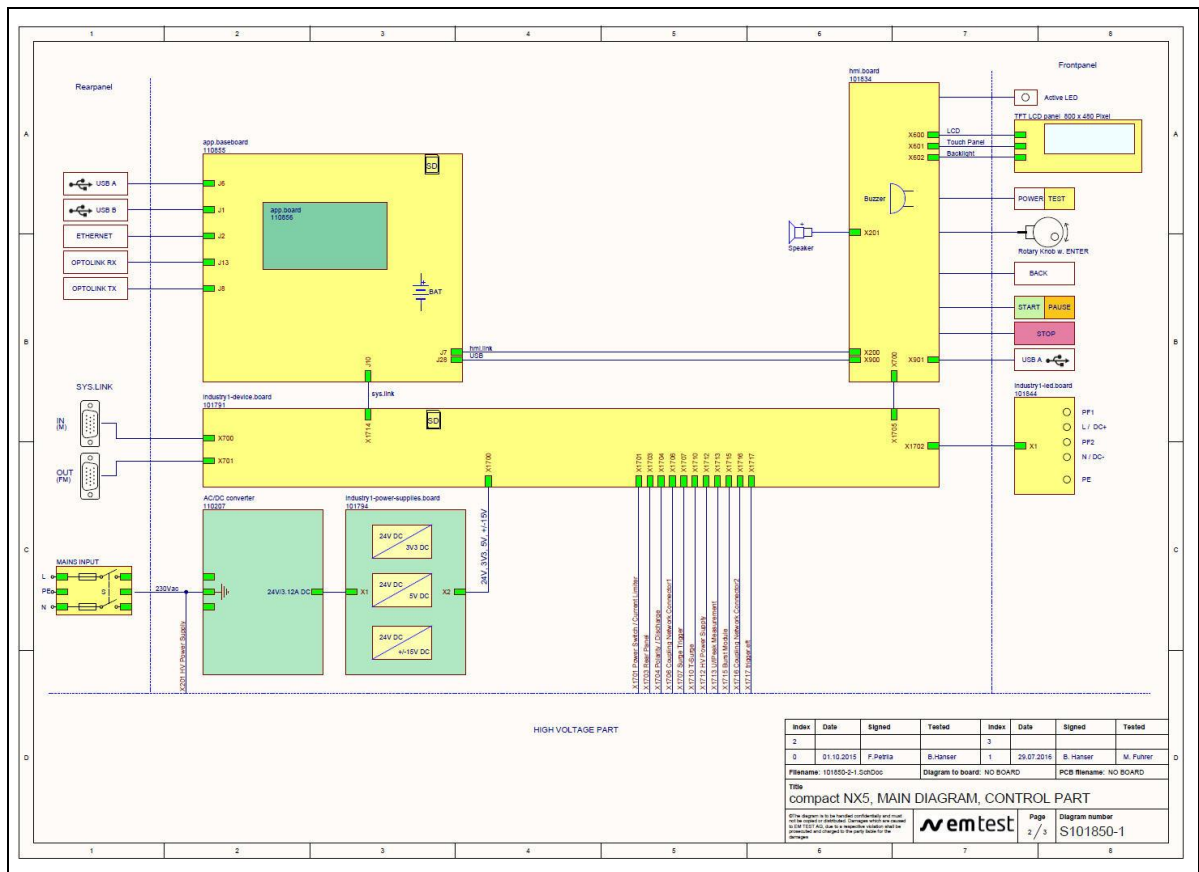

16.4. Main diagram high voltage connection

