

Manual

For Operation

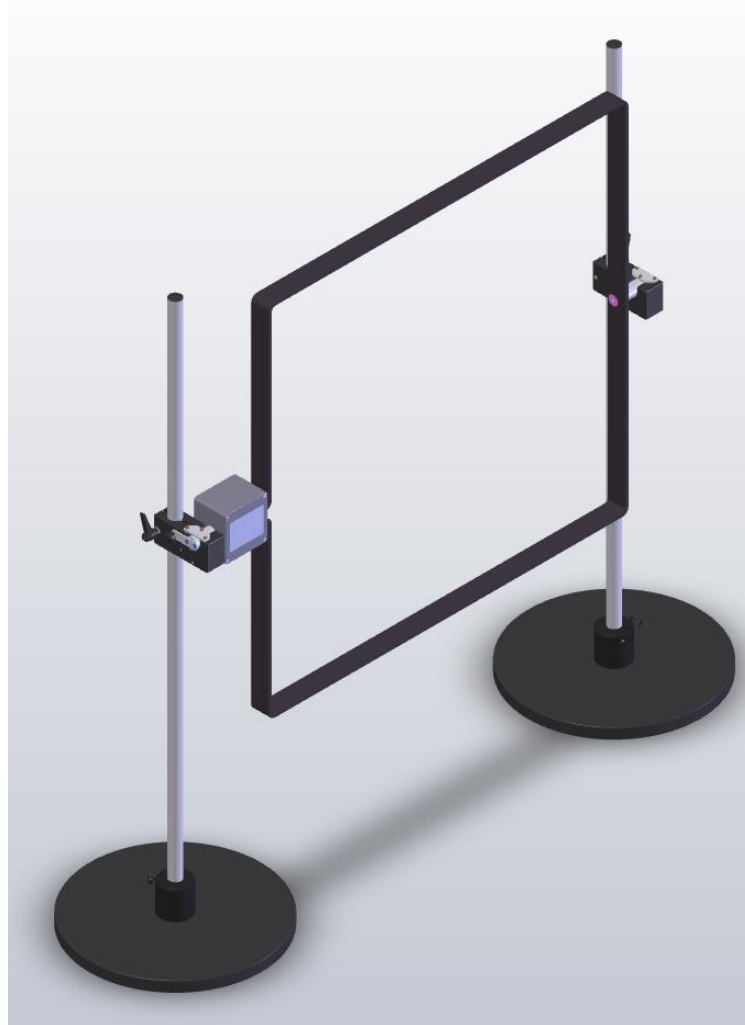

Magnetic field testing

50 / 60 Hz power magnetic field
Pulsed magnetic field

MFC 1000.1, MFC 1000 Antenna
MFT 30 current transformer
MFT 100-120 current transformer (120 V)
MFT 100-230 current transformer (230 V)

EN/IEC 61000-4-8
EN/IEC 61000-4-9
EN 61000-6-1
EN 61000-6-2

AMETEK CTS GmbH
Sternenhofstrasse 15
4153 Reinach BL1
Schweiz

Phone : +41 61 204 41 11
Fax : +41 61 204 41 00

URL : <http://www.ametek-cts.com>

Copyright © 2020 AMETEK CTS GmbH

All right reserved.
Specifications subject to change

Contents

1.	Model Overview	4
1.1.	Generators	4
1.2.	Magnetic field antenna	7
1.3.	Cable to the magnetic field antenna	8
1.4.	Current transformers	9
1.4.1.	Measure the transformer and current factor	9
1.4.2.	Current transformer MFT 30	10
1.4.3.	Current transformers MFT 100-120/230	12
2.	Test Setup	13
2.1.	IEC 61000-4-8 50/60 Hz magnetic field with compact NX5/NX7	13
2.1.1.	Magnetic field as per IEC 61000-4-8	14
2.1.2.	Required device settings to perform a power frequency magnetic field test	15
2.1.3.	Test setup with MFT 30 for H-Fields up to 30 A/m	16
2.1.4.	Test setup with MFT 100 for H-Fields up to 1.000 A/m	18
2.2.	IEC 61000-4-8 50/60 Hz magnetic field with NSG 3040A/3060A	20
2.2.1.	Quick Start	20
2.2.2.	Required device setting to perform a power frequency magnetic field test	21
2.2.3.	Test setup for power frequency magnetic field test	22
2.2.4.	Test setup with MFT 30 for H-Fields up to 30 A/m	22
2.2.5.	Test setup with MFT 100 for H-Fields up to 1.000 A/m	23
2.3.	Verification of the generator characteristic as per IEC 61000-4-8	24
2.4.	IEC 61000-4-9 Pulsed magnetic field with compact NX5/NX7	25
2.4.1.	Magnetic field as per IEC 61000-4-9	25
2.4.2.	Pulsed Magnetic field operation	25
2.4.3.	Setup pulsed magnetic field	26
2.5.	IEC 61000-4-9 Pulsed magnetic field with NSG 3040A/3060A	27
2.5.1.	Quick Start	28
2.5.2.	Standard test Routine	28
2.5.3.	User Test Routines	29
2.5.4.	Magnetic field as per IEC 61000-4-9	29
2.5.5.	Setup pulsed magnetic field	30
2.6.	IEC 61000-4-10 Damped Magnetic Field	31
3.	Technical data	32
4.	Standards	33
4.1.	IEC 61000-4-8	33
4.2.	IEC 61000-4-9	33
4.3.	IEC 61000-4-10	34
4.4.	Application of IEC 61000-4-8 and 9	34
5.	Maintenance and service	35
5.1.	General	35
5.2.	Calibration and Verification	35
5.2.1.	Factory calibration	35
5.2.2.	Guideline to determine the calibration period of AMETEK CTS instrumentation	35
5.2.3.	Calibration of Accessories made by passive components only:	35
5.2.4.	Periodically In-house verification	35
5.3.	Maintenance	36
5.3.1.	Cleaning	36
6.	Delivery groups	36
6.1.	Antenna MFC 1000.x	36
6.2.	MFT 30 Magnetic field transformer	36
6.3.	MFT 100 Magnetic field transformer	36
7.	Appendix	37
7.1.	Declaration of CE-Conformity	37

1. Model Overview

1.1. Generators

To realize the different test procedures the following AMETEK CTS generators are required:

IEC 61000-4-8	NetWave7 compact NX 5/7 series NSG 30x0A series UCS 500N5/7 series PFS 500 or PFS 503	preferred ac source preferred test generator preferred test generator with restriction possible
IEC 61000-4-9	compact NX 5/7 series NSG 30x0A series UCS 500N5/7 series UCS 500 series VCS 500	preferred test generator preferred test generator
IEC 61000-4-10	OSC 500N series	

Additional equipment for magnetic field testing

<p>Magnetic field antenna MFC 1000.1</p> 	<p>Rectangular antenna single turn 1m x1m square Double stand on feet</p>
<p>Magnetic field antenna MFC 1000</p> 	<p>Rectangular antenna single turn 1m x1m square Double stand on casters with brakes</p>
<p>Current transformer MFT 30</p> 	<p>Current transformer for the range of 30A/m</p>
<p>Current transformer MFT 100</p>  <p>Plug 14mm</p>	<p>Current transformer for the range of 80A/m to 1000A/m</p> <p>For application of magnetic fields higher than 600A/m using a motor variac NX1 or VAR 3005A-S16, a mains voltage of 230V is necessary. Mains with 115V needs an external booster transformer 115V to 230V 10kVA.</p> <p>If the MFT100 is delivered to an existing previous model MS100, two additional plugs are delivered for connect to MS100.</p>

variac NX1-260-16 with compact NX5/NX7



Motor variac 0-260V/16A

VAR 3005A-S16 with NSG 3040A/3060A



Motor variac 0-260V/16A

Netwave 7



AC-DC source Netwave 7

Generators

The most comfortable test equipment to conduct magnetic field tests as per IEC 61000-4-8 and IEC 61000-4-9 is the compact generator type **compact NX5 / compact NX7, NSG 3040A, NSG 3060A series**.

For easy testing 50Hz / 60Hz magnetic field an ac source like **NetWave** is very comfortable.

- **Maximum control comfort.**

The most powerful control capabilities are included in the compact NX and NSG 30x0A series generators. Within these units the magnetic field test is integrated in the device app software as well as in the user friendly iec.control windows software.

- **Alternatives**

Magnetic field tests can also be conducted together with a VCS 500N surge generator (IEC 61000-4-5) and PFS 500N series generator (IEC 61000-4-11). It is necessary to modify the DIPS or surge routines for perform these tests.

Pulsed magnetic field

The pulsed magnetic field as per IEC 61000-4-9 will be realized by using a surge generator as per IEC 61000-4-5. Some older generators require an additional 18 uF capacitor, that is in series with the coil antenna. Newer surge generators have already a built in 18 uF capacitor

1.2. Magnetic field antenna

The correction factor of the magnetic field antenna type MFC 1000 series is **0.87**. This means that an antenna current of 100 A will generate a magnetic field of 87 A/m in the center of the antenna (1m x 1m Antenna). To achieve 100 A/m an antenna current of 114.94 A is necessary.

This factor is also an important value which shall be entered to the software. Depending on the dimension and the design of the antenna this factor will change.

$$F_{Ant} = \frac{H \text{ Field [A / m]}}{I_{Antenna} [A]}$$

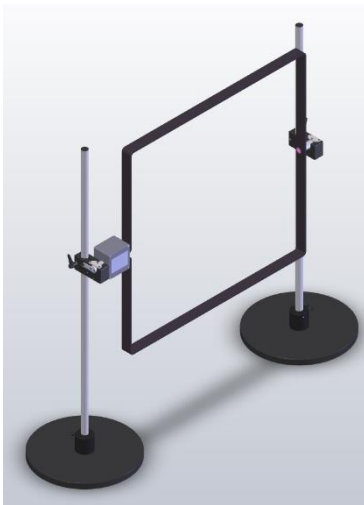
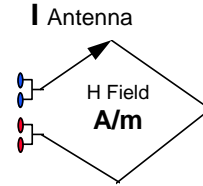

Magnetic field antenna MFC 1000.1

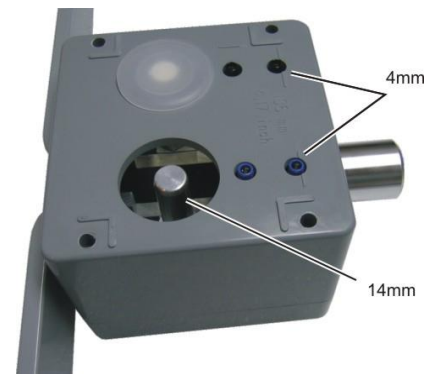

Plugs for connect MFC 1000.x

The magnetic field antenna has two different types of connectors.

- Two sets of parallel safety banana connectors for the range of 30 A/m and an optional set of connectors for higher currents.
- The high current 14mm connectors are used with the MFT 100 only. The cables are part of the transformer.

Fix and unlock mechanical parts

By lifting the grip, the free movement of the serration
toothing enables the clamping lever to swing into
the desired position.
The grip moves into its original position when
released



Operating

	MFT 30 ≤30A/m	Coil and cables will not get hot After the test you can touch the antenna coil.
	MFT 100 ≤100A/m	
	4mm plug Multi Contact cable	Cables can get hot approx 50°C during operation when using with current >50A. Do not touch the coil during or 10 minutes after the test
	Cable with 14mm Multi Contact plug	Cables can get hot approx. 55°C after repetitive 3s test duration Do not touch the cable during or 10 minutes after the test.

1.3. Cable to the magnetic field antenna

According to the standard the cable between the magnetic field generator (Transformer) and Antenna should be

- Twisted
- Max. 2 m as per IEC 61000-4-8
- Max. 3 m as per IEC 61000-4-9

The delivered 2.5 mm² cables have a length of 2 m \pm 5% and must be prepared for the magnetic field test. The user must twist or weave the four wires to a cable that has a total length of less than 2.0 m

This arrangement with a twisted cable has the following advantages:

- the cable radiates less, because the field is compensated
- The inductance of the cable loop is less
- Better handling because only one cable is there for the setup

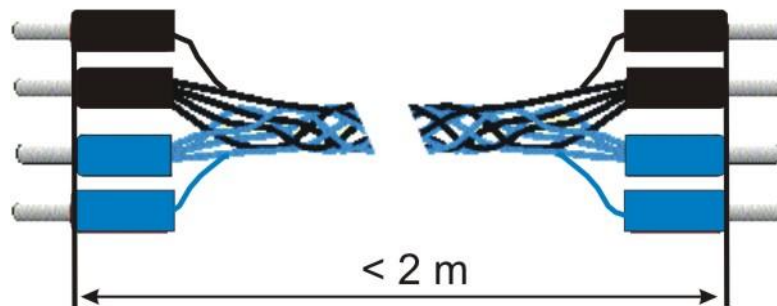

1.4. Current transformers

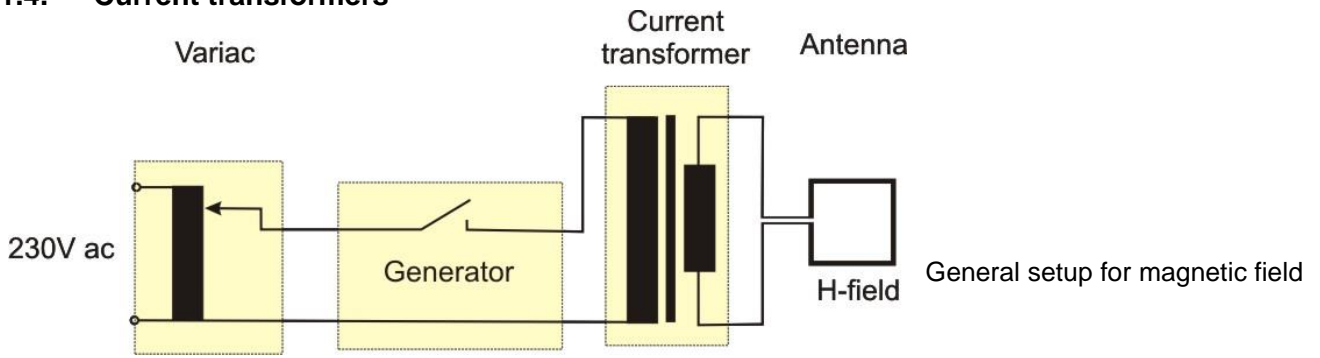

Two different current transformers are available:

- MFT 30 to generate continuous magnetic fields up to 30 A/m
- MFT 100 to generate continuous magnetic fields from 80 up to 100 A/m and short time magnetic fields up to 1000 A/m.

The transformers can be interchanged depending in which range the operator has to test.

Please use always the attached original connection cables. Your system was calibrated together with these cables and the equivalent transformation factors are part of the software.



Using other components, the test setup shall be recalibrated and the equivalent factors shall be entered to the software. Changing the test setup will require also a change of the factors (see para. 5.0 verification).

Magnetic field testing needs 230 V mains voltage for user with motor variac (variac NX1-260-16 / VAR 3005A-S16). An external booster transformer (115 V to 230 V 10 kVA) is necessary for 115 V mains.

Transformer factor F

$$F_{\text{Trafo}} = \frac{I_{\text{Antenna}} [A]}{U_{\text{Prim Transformer}} [V]}$$

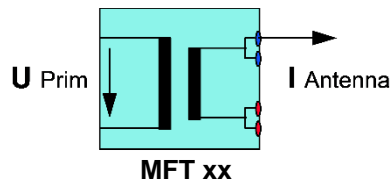

The given transformer factor is valid for short test up to one minute. For longer tests this factor will change, till the system is in a stable temperature balance (10-20 minutes). Special higher currents are heating up the cables and antenna. Therefore, the ohmic value of the cables and antenna increases during the test. The reason is the heating caused by the high current. For longer application it can be necessary to readjust the voltage when the temperature of the cable and antenna is stable.

1.4.1. Measure the transformer and current factor

The test setup can be checked at the following measuring points.

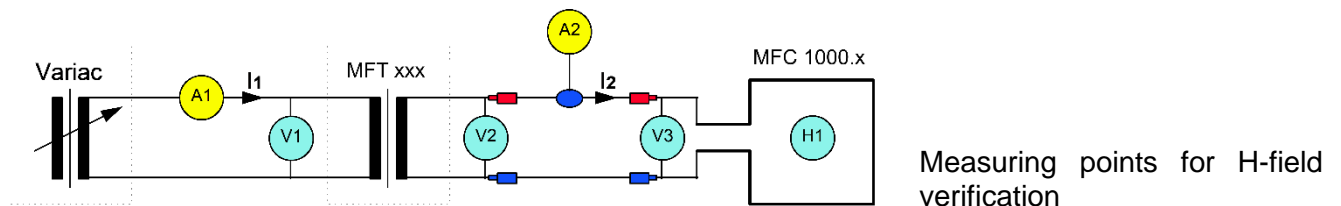

For verification the magnetic field please uses the following testpoints:

- V1** Primary voltage magnetic field transformer
- A2** Current in the antenna Loop (measured with a current transformer).
- H1** H-field (measured with a H-field sensor).

Other measuring points, as shown in the figure above can be used for H-field measurements.

1.4.2. Current transformer MFT 30

The MFT 30 has two current ranges 3 A and 30 A. The ranges can be select with the switch at the rear side of the MFT 30. The two parallel current outputs to the antenna can be used with connectors for 4 mm or 50 A.



The V/I characteristic of the transformer determines the voltage at the output of the variac to generate the specified magnetic field. because the magnetic field antenna has a very small impedance the impedance of the wiring mostly determines the V/I characteristic of the current transformer.

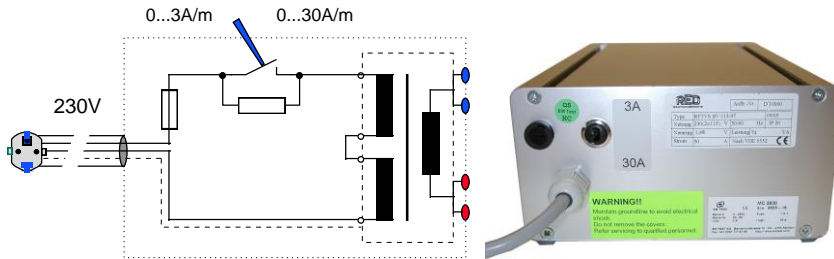

Transformer Factors

Range 0...3 A : approx.. 0.043 A/V

Range 0...30A : approx.:0.434 A/V

Diagram and Current factor of MFT 30

The following table shows the voltage setting in dependency to the selected current range:

H-field [A/m]	Range 3 A Primary voltage at MFT 30 [V]	Range 30 A Primary voltage at MFT 30 [V]	Antenna current [A]
1	26.8		1.15
3	80.0	7.5	3.46
10	(263)	25.5	11.5
30		77.5	34.48

Characteristics range 3A

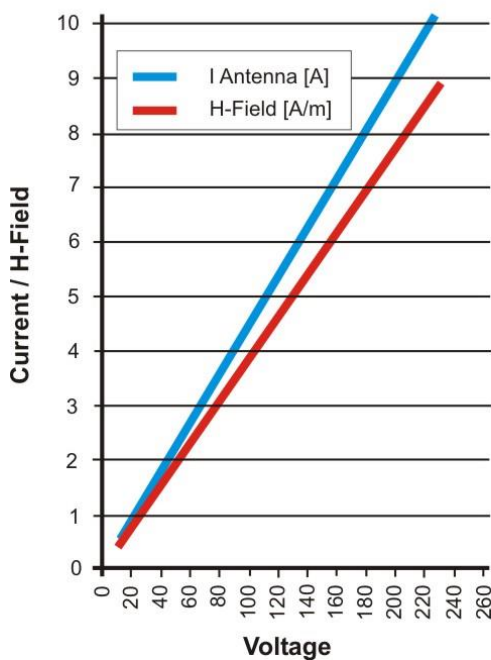

Characteristics range 30A

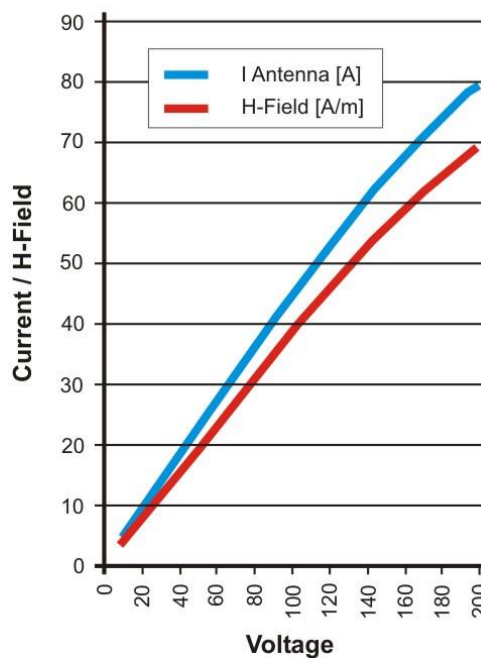

Connection transformer - antenna:

Use two parallel, 2 m long safety banana cables

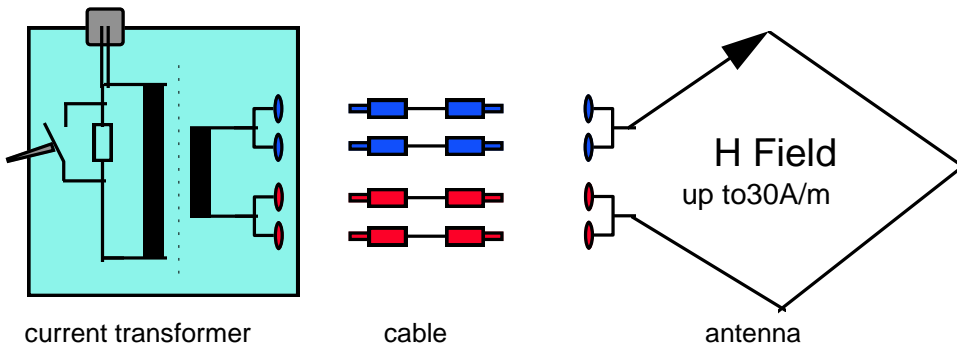

The Transformer Factor is influenced by the heating of the cables. For continuous testing with magnetic fields > 10 A/m check the current with a current probe. Adjust the voltage setting if necessary.

1.4.3. Current transformers MFT 100-120/230

The MFT 100 is used for high magnetic fields from 80 A/m up to 1000 A/m. The transformer is rated for constant current of 250 A. An internal overtemperature sensor will protect the transformer. Cause off high primary current a contactor switches on and off the current. This switch can be operated from the compact NX5/NX7 or NSG 3040A/3060A, while the current connection is direct from the motor variac (variac NX1-260-16 or VAR 3005A-S16). There are 2 versions available: MFT 100-120 for 120 V power supply and MFT 100-230 for 230 V power supply, both devices are optically identical.

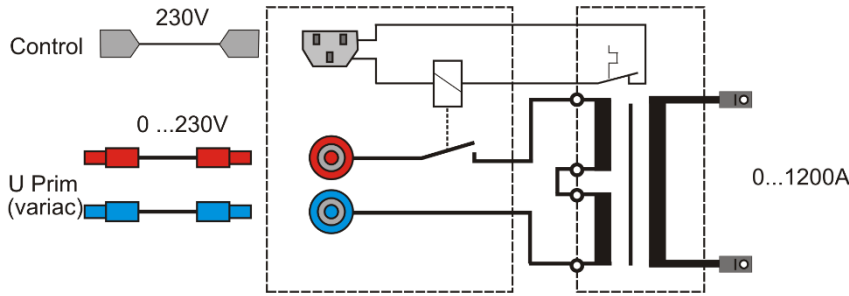

Transformer Factor
Approx.. 7.90 A/V

Diagram and Current factor of MFT 100

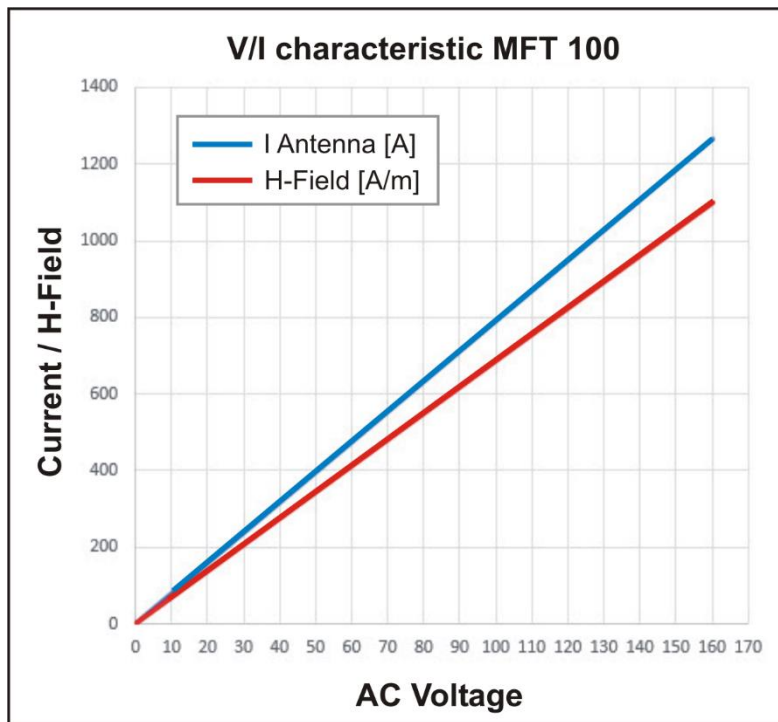

Transformer factor 7.90



The Transformer Factor is influenced by the heating of the cables. For continuous testing check the current with a current probe and adjust the voltage setting.



Using a variac with mains of 100 V or 115 V, the maximum achievable magnetic field is approx. 750 A/m.
For generate H-fields > 750 A/m it is necessary to connect a booster transformer 115 V -> 230 V/10 kVA

2. Test Setup

Possible test setups for H-field tests

Motorvariatic and compact NX / NSG 30x0A

The generator controls the motorvariatic via the 0-10 V analog signal. The selected voltage will generate the current in the antenna loop.

From app.sw ver 6.3 you can choose whether the variac is connected to a rack. In this case the setup changes, please see chapter 2.1.3 (MFT 30) and 2.1.4 (MFT 100) for more details. This option is available for compact NX only.

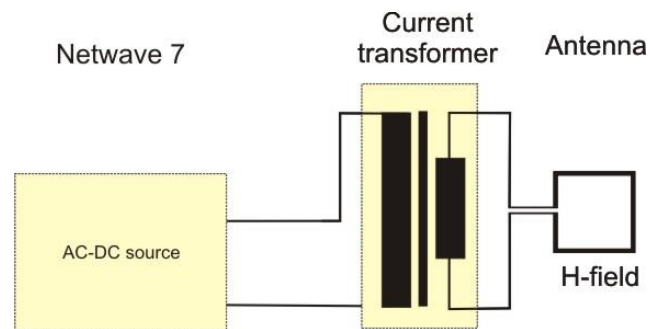
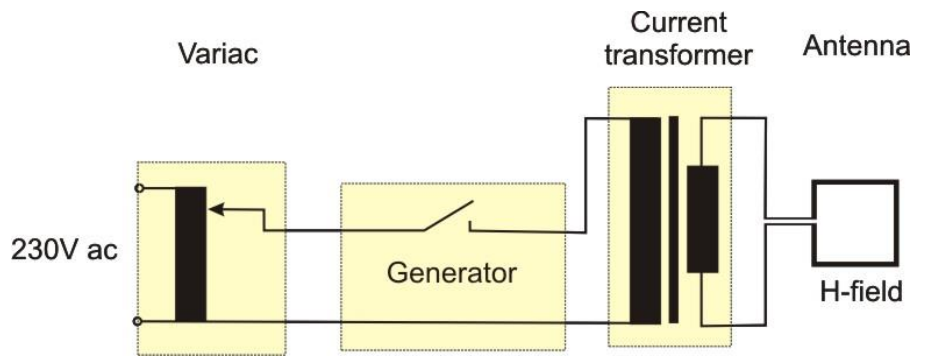

AC / DC source Netwave 7

The programmable AC/DC source directly generates the voltage and frequency. Various frequencies are the advantage using a programmable power supply.

2.1. IEC 61000-4-8 50/60 Hz magnetic field with compact NX5/NX7

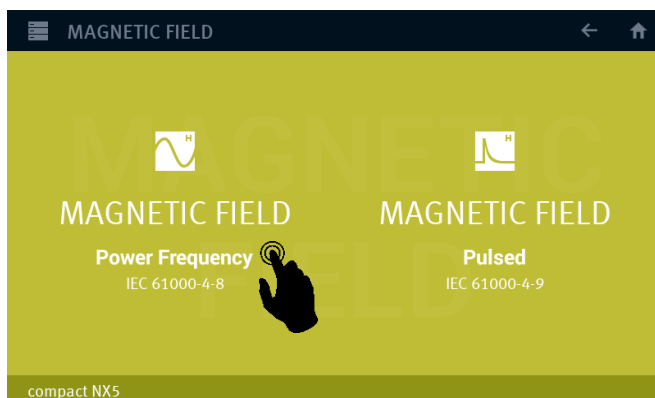

Main Menu Magnetic Field separated to “Power frequency” and “Pulsed”

Select “Power Frequency” to perform tests according IEC 61000-4-8.

2.1.1. Magnetic field as per IEC 61000-4-8

The menu offers different test routines for power frequency magnetic field testing.

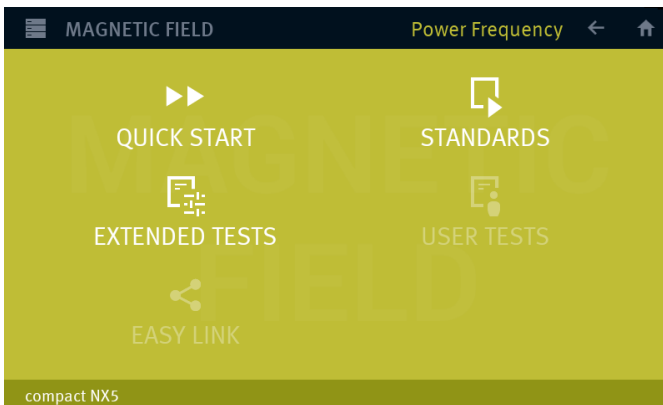

Main menu ac powered magnetic field

The Magnetic Field menu offers different test routines for pulsed magnetic testing.

Quick Start

Easy and fast online-operation with the phenomenon magnetic-field. In this menu the user can operate all test manually with online change the most parameters during a test.

Standard

The operator can select between various preprogrammed test routines as required in different standards

Extended Tests

The operator can select between various preprogrammed test routines which helps to accelerate testing and which are very helpful especially during design.

User test routines

The user defined library where all created magnetic field tests are stored.

Easy Link

Link files library created during the actual session. The user can easy save a test into the Easy Link library. After switch off the Equipment all Easy Link tests are deleted. Use "SAVE AS USER TEST" for definitive save the test.



Warning

For magnetic field testing the power mains input at PF1 shall be disconnected.

Test setup

The voltage V is adjusted with a variac as long as the required antenna current is available and the related H field is generated in the center of the magnetic field antenna.

The variac NX1-260-16 is controlled automatically via the test generator. Any equivalent variac available in the lab can be used to control the current manually. Please take care that the variac has a sufficient current capability.

2.1.2. Required device settings to perform a power frequency magnetic field test

For perform a 50/60 Hz magnetic field test, the NX5 generator must be configured with the used hardware in the menu:

Menu / SETUP / Equipment

1. Variable transformer:

- variac NX 1-260-16
- variac NX 1-260-32

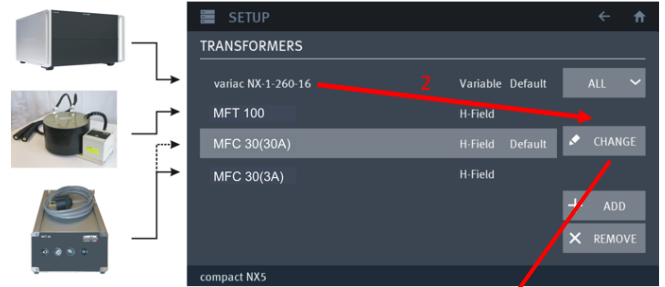

2. Wiring of variac NX 1

From app.sw ver 6.3 you can choose whether the variac is connected to a rack. To change the setup, select the variac NX 1 (2) and then use the CHANGE button to select the wiring.

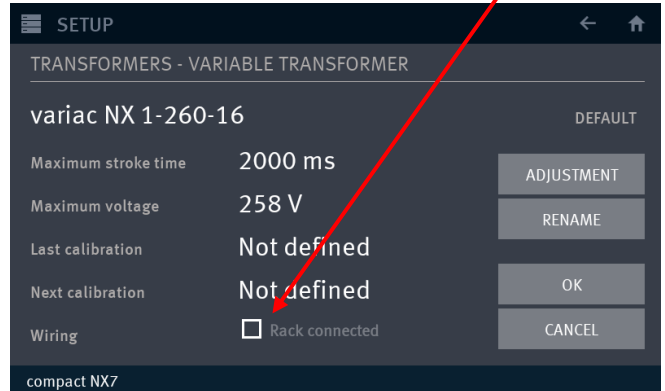

3. Magnetic current transformer

- MFT 100 H-field 80 to 1.000 A/m
- MFT 30 (3 A range) H-field 1 to 10 A/m
- MFT 30 (30 A range) H-Field 1 to 44 A/m



The MFT 30 has two ranges and therefore the NSG generator list this current transformer in the configuration for (3 A) and (30 A) range. Set the range switch of the MFT 30 to the correct position before starting the test.

Menu / SETUP / EXTERNAL COUPLERS

4. Magnetic field antenna:

- MFC 1000.x

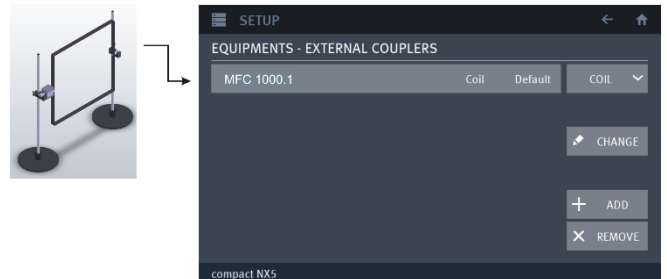

2.1.3. Test setup with MFT 30 for H-Fields up to 30 A/m

Variant 1: variac NX 1-260-xx not Rack connected (MFT 30)

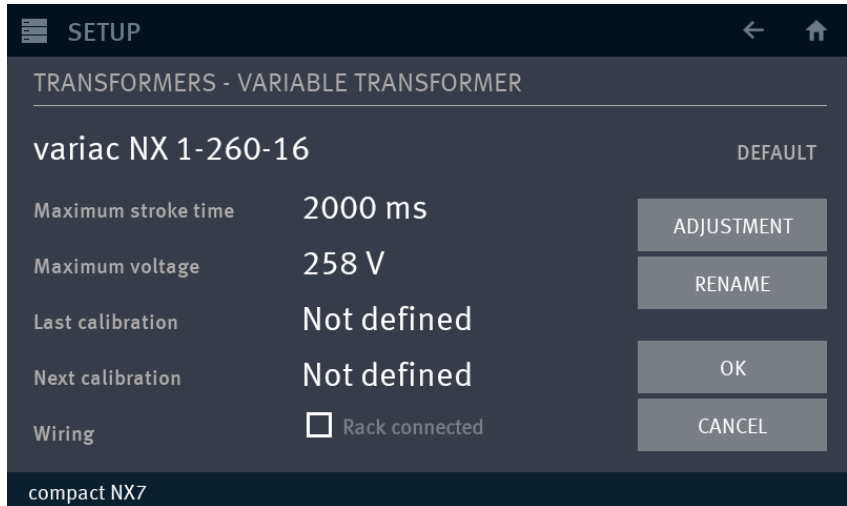

Disable option “Rack connected”

In this case the switch PF1 is not used and remains open, the test is switched via the switch PF2

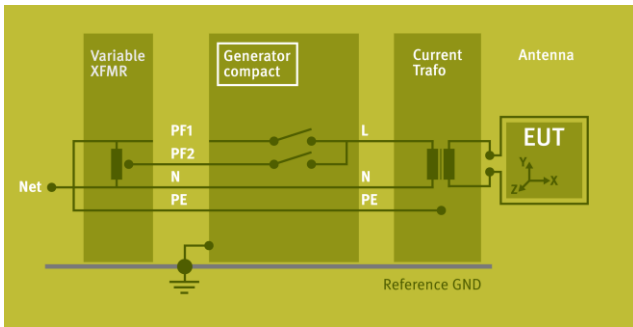

Schematics

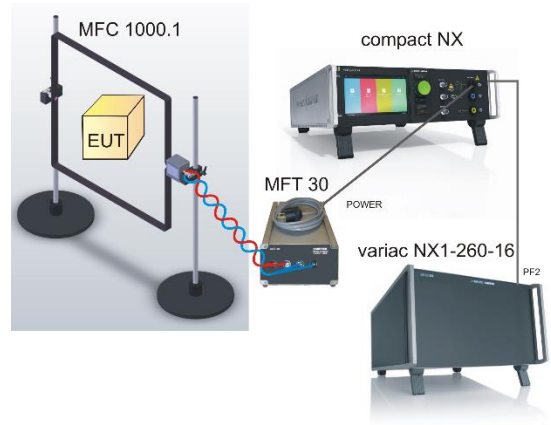

Test setup

Schematics and Test setup with compact NX, variac NX1-260-16, MFT 30 and MFC 1000.x

Option for required magnetic field tests as per IEC 61000-4-8

- External variable motor transformer **variatic NX1-260-16**
- External magnetic field antenna **MFC 1000.x**
- External current transformer **MFT 30** to test 1, 3, 10 and 30 A/m levels (continuous)

Variac 2: variac NX 1-260-xx Rack connected (MFT 30)

Enable option “Rack connected”

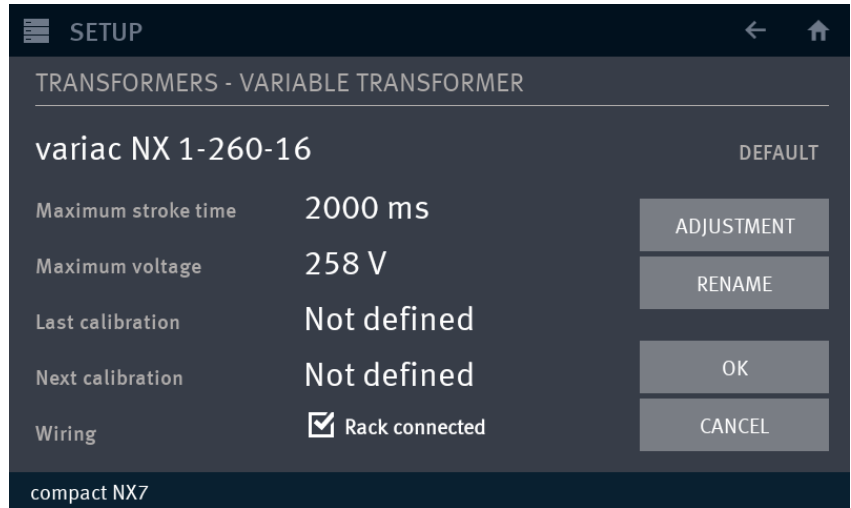

In this case, the rack cabling does not need to be changed, the PF1 connection between variac NX1-260-xx and the compact NX can remain. However, switch PF1 remains open, the test is still switched via switch PF2.

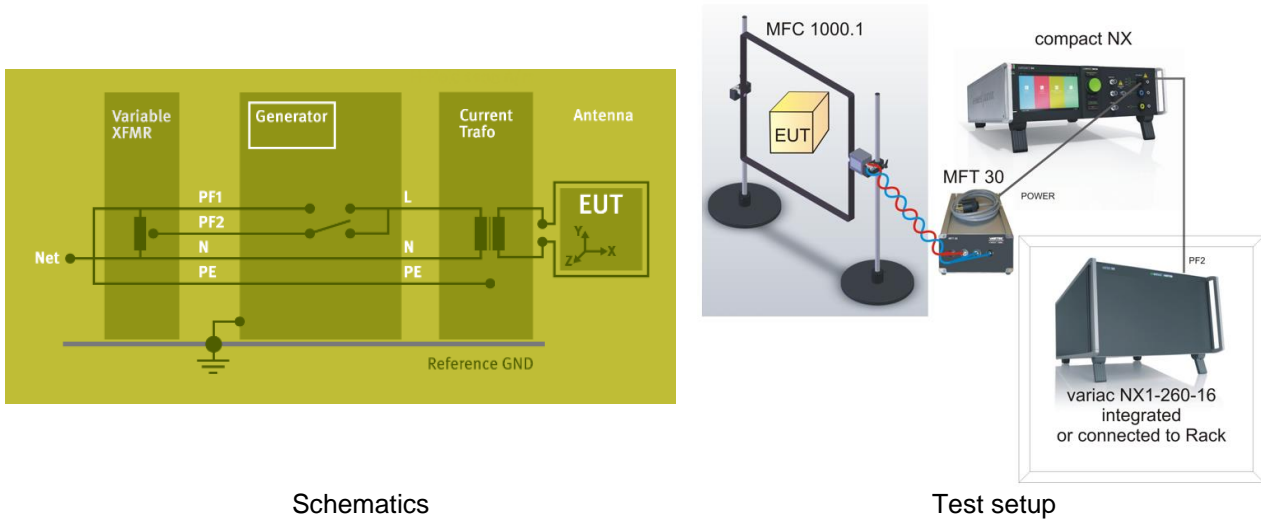

Schematics and Test setup with compact NX, variac NX1-260-16, MFT 30 and MFC 1000.x

Option for required magnetic field tests as per IEC 61000-4-8

- External variable motor transformer **variatic NX1-260-16**
- External magnetic field antenna **MFC 1000.x**
- External current transformer **MFT 30** to test 1, 3, 10 and 30 A/m levels (continuous)

2.1.4. Test setup with MFT 100 for H-Fields up to 1.000 A/m

Variac 1: variac NX 1-260-xx not Rack connected (MFT 100)

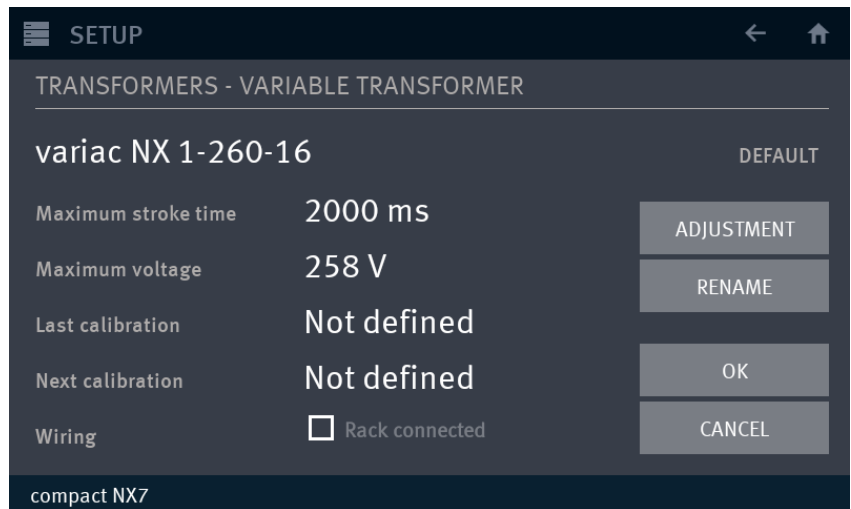

Disable option "Rack connected"

Switch PF2 is used to switch the relay in the MFT 100 with the mains voltage, thus switching the test on/off. Switch PF1 is not required for this test and remains open. The controlled variable is fed directly from the PF2/N output on variac NX to the MFT 100.

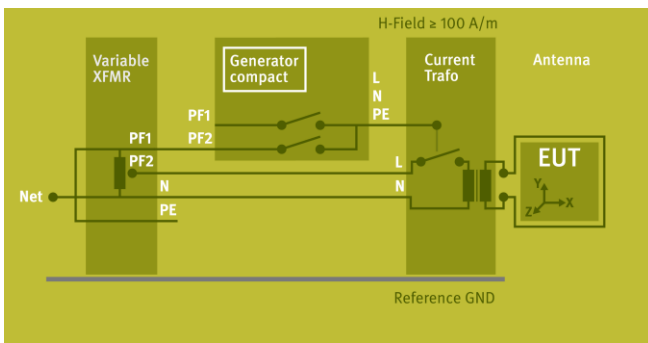

Schematics

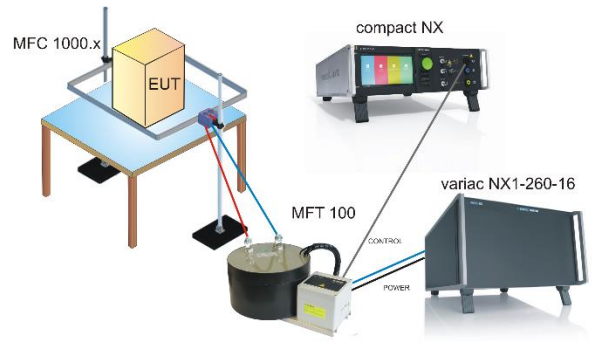

Test setup

Schematics and Test setup with compact NX, variac NX1-260-16, MFT 100 and MFC 1000.x

Option for required magnetic field tests as per IEC 61000-4-8

- External variable motor transformer **variatic NX1-260-16**
- External Magnetic field antenna **MFC 1000.x**
- External current transformer **MFT 100** to test 100 A/m (continuous) and up to 1.000 A/m (short-term)

Tests with 1.000 A/m magnetic field

During tests with a field of 1.000 A/m the primary current of variatic NX1-260-16 during the 3s testtime goes to approx. 39A. The motorvariatic can withstand this load for this short time. The figure below shows the load diagram. Therefore, the variatic NX1-260-16 can withstand during approx. 45s a current of 39A. Normally the fuses do not break during the 3s test time.

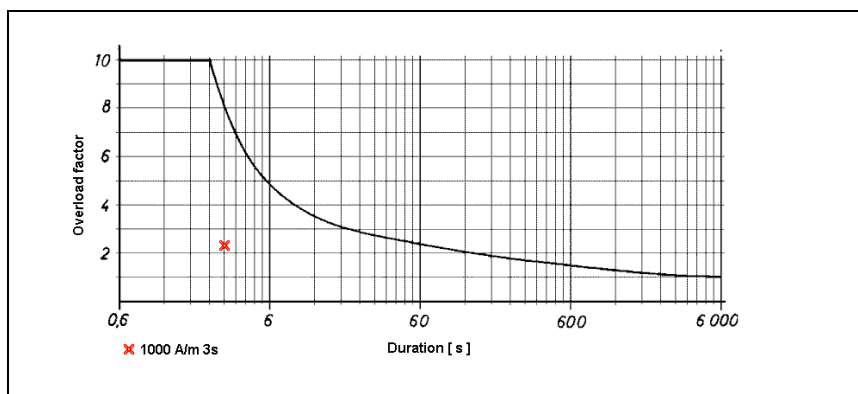

Load diagram variatic NX1-260-16

Variac NX 1-260-xx Rack connected (MFT 100)

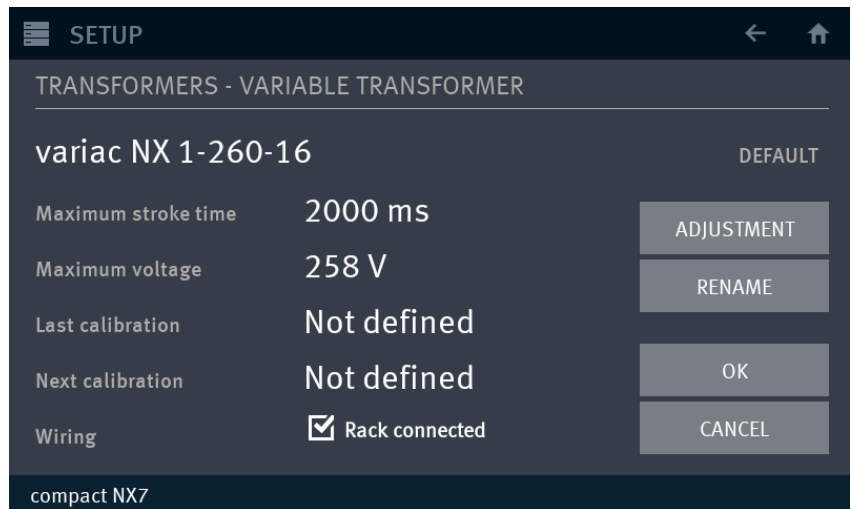

Enable option "Rack connected"

In this case the relay in the MFT 100 is switched on/off via the PF1 (compact NX) switch. The connection from the variac NX (PF2) to the compact NX (PF2) remains and does not need to be changed. The PF2 switch in the compact NX remains open and is not used for this test. Instead, there is another connection from the variac NX (PF2/N) to the front panel in the rack. From there the controlled variable is fed to the MFT 100.

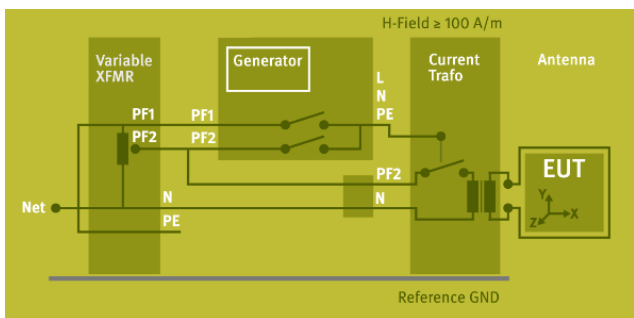

Schematics

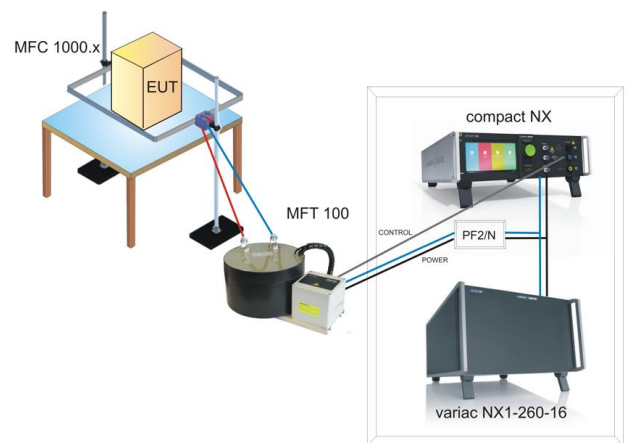

Test setup

Schematics and Test setup with compact NX, variac NX1-260-16, MFT 100 and MFC 1000.x

Option for required magnetic field tests as per IEC 61000-4-8

- External variable motor transformer **variatic NX1-260-16**
- External Magnetic field antenna **MFC 1000.x**
- External current transformer **MFT 100** to test 100 A/m (continuous) and up to 1.000 A/m (short-term)

2.2. IEC 61000-4-8 50/60 Hz magnetic field with NSG 3040A/3060A

The Power magnetic menu offers different test routines for magnetic field testing.

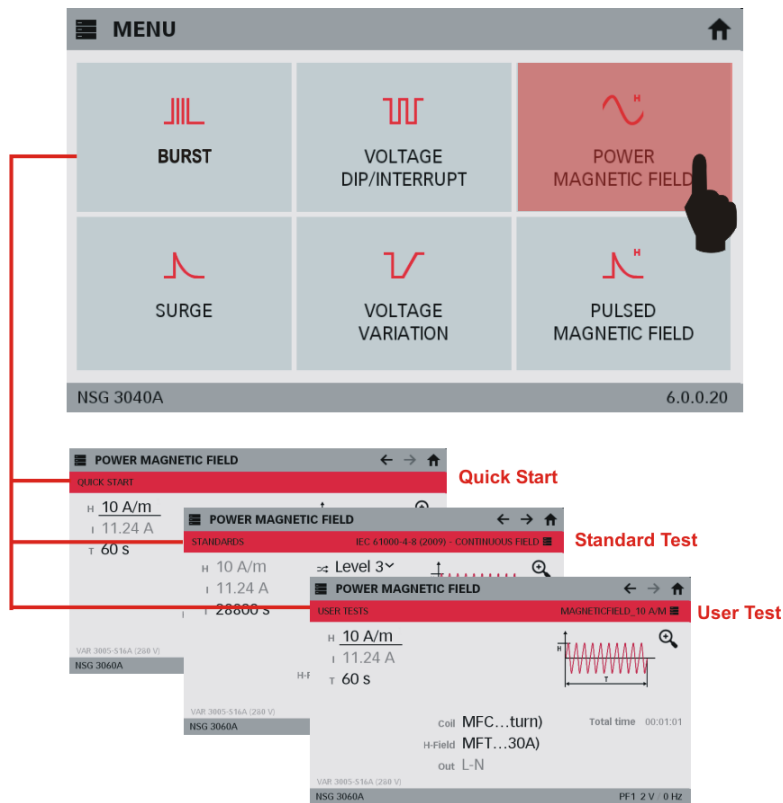

Click into Power Magnetic Field menu loads the last used menu of the following routines below.

Quick Start

Easy and fast online-operation with the phenomenon magnetic field. In this menu the user can operate a magnetic field test manually with online change of most parameters during a test.

Standard

The operator can select between various preprogrammed test routines as required in different standards. The standard library is filtered according to the EUT setting (AC, DC etc.)

User test routines

The user defined library where all created magnetic field tests are stored.

2.2.1. Quick Start

Easy and very fast operation of all standard functions of the equipment. The latest simulator settings are stored automatically and will be recalled when Quick Start is selected.

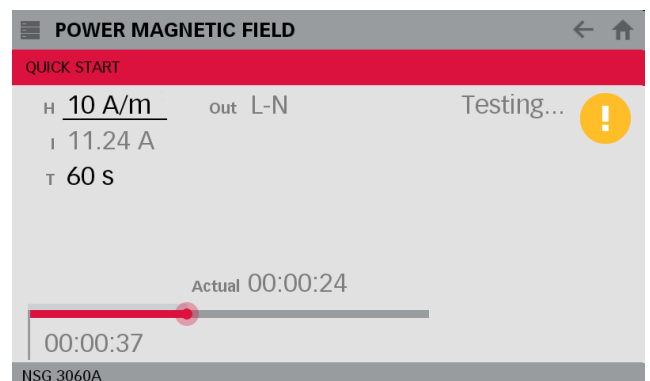
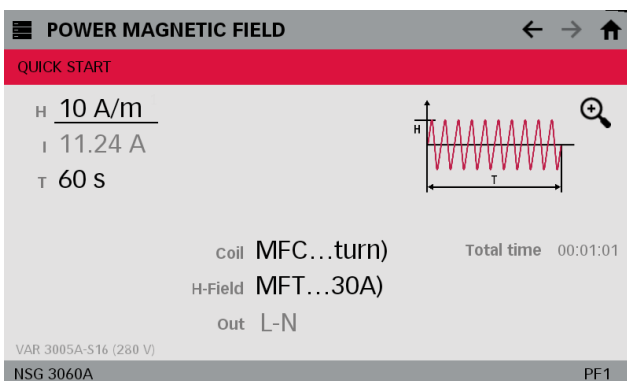

2.2.2. Required device setting to perform a power frequency magnetic field test

To perform a 50/60 Hz magnetic field test, the NSG generator must be configured with the used hardware in the menu:

Menu / SETUP / Equipment

1. **Variable transformer:**
- VAR 3005A-S16
2. **Magnetic current transformer**
 - MFT 30 (3 A range) H-field 1 to 10 A/m
 - MFT 30 (30 A range) H-field 1 to 44 A/m
 - MFT 100 H-field 80 to 1.000 A/m

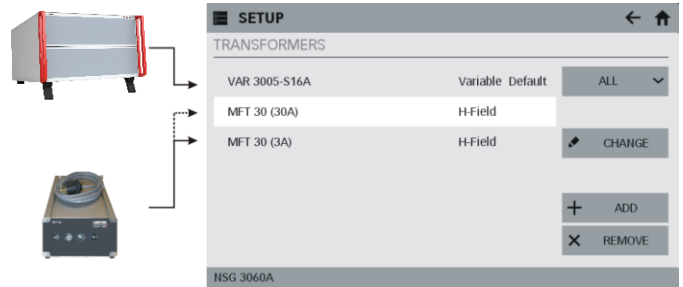

The MFT 30 has two ranges and therefore the NSG generator list this current transformer in the configuration for (3 A) and (30 A) range. Set the range switch of the MFT 30 to the correct position before starting the test.

To adjust the Transformer factor, use menu / SETUP / TRANSFORMERS

The transformer factor is defined as follow:

$$\text{Transformer factor} = \frac{\text{Antenna current [A]}}{U_{\text{prim MFT 30 [V]}}$$

For more information see chapter 1.4.2 current transformer MFT 30

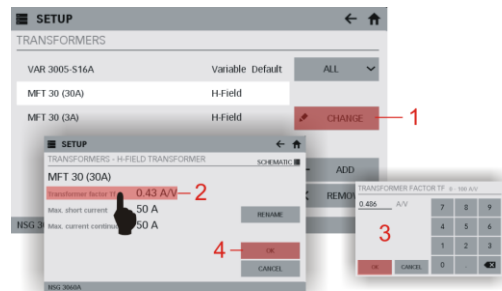

Menu / SETUP / EXTERNAL COUPLERS

3. **Magnetic field antenna:**
- MFC 1000.1

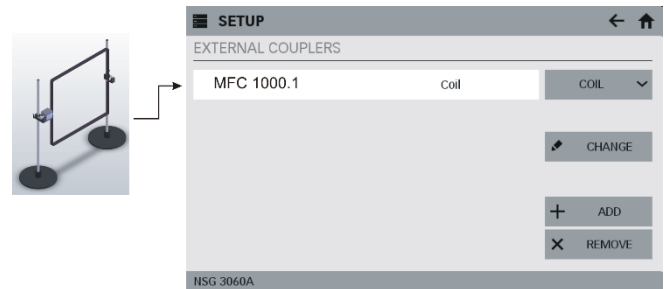

The coil or antenna factor is defined as follow:

$$\text{Coil factor} = \frac{\text{H-field antenna [A / m]}}{I_{\text{antenna [A]}}$$

For more information see chapter 1.2 Magnetic field antenna

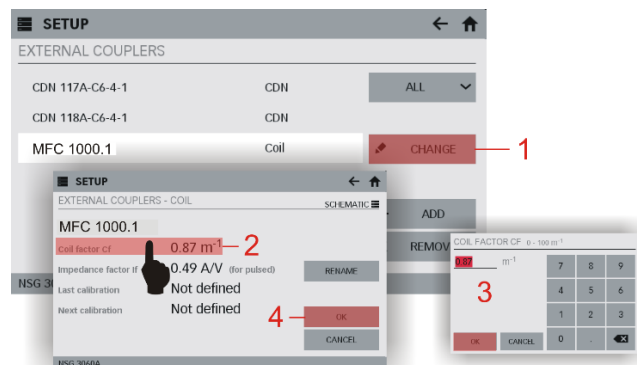

2.2.3. Test setup for power frequency magnetic field test



For magnetic field testing the power mains input at PF1 must be disconnected.

A message appears to confirm, that the PF1 generator input is disconnected from the mains. This guarantees that in the event of a fault, the 230 V mains voltage can never be applied to the MFT 30 and that a high H-field is present.

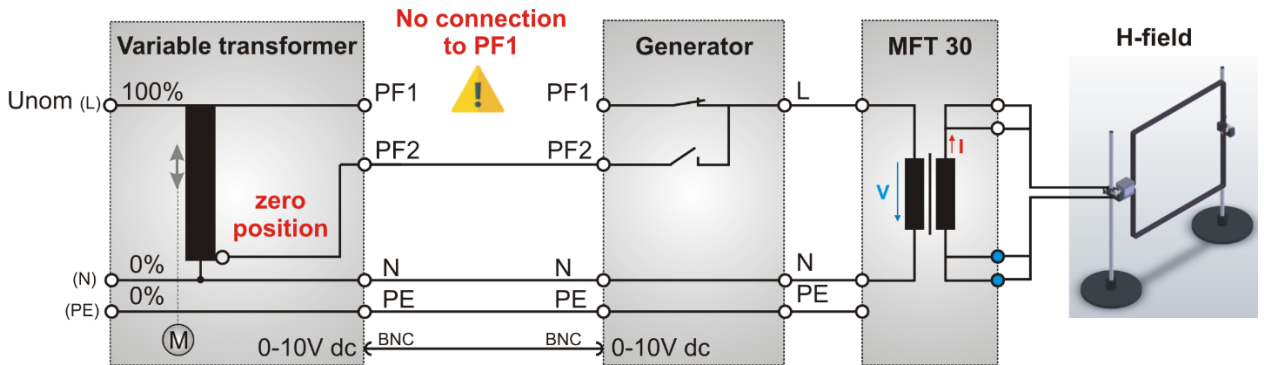
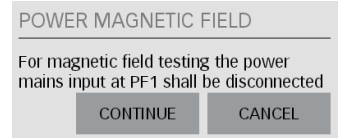

The voltage V is adjusted with a variable transformer. The MFT 30 is a short circuit transformer that generates the required current into the 1 m x 1 m loop antenna with one turn. For the standard antenna, the standard defines a current of 1,145A for a magnetic field of 1 m⁻¹.

The variable transformer VAR 3005A-S16 will be controlled automatically via the test generator. Any equivalent manual transformer available in the lab can be used to control the current manually. Please take care that the variable transformer has enough current capability.

2.2.4. Test setup with MFT 30 for H-Fields up to 30 A/m

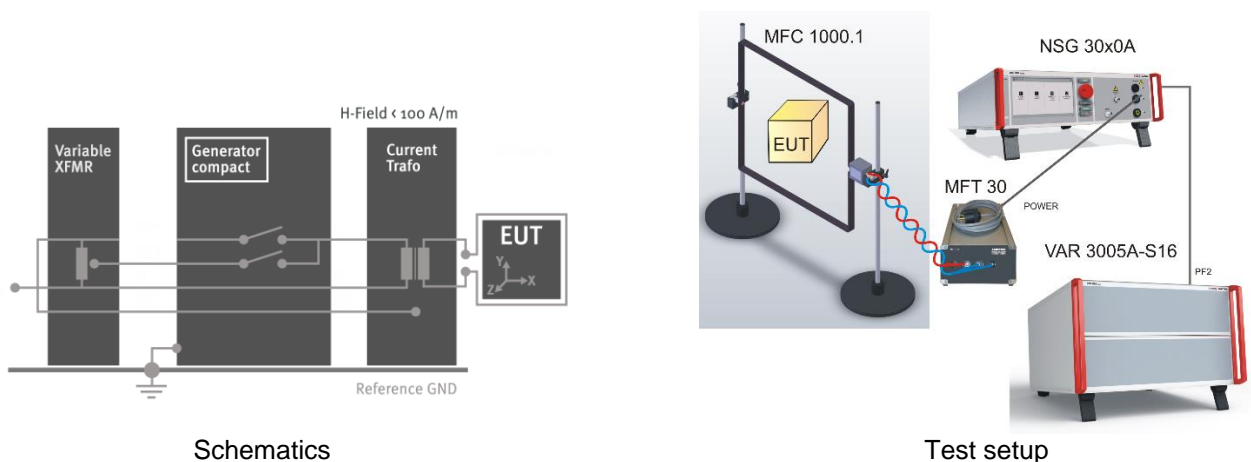

Schematics and Test setup with NSG 3040A, VAR 3005A-S16, MFT 30 and MFC 1000.1

Options required for magnetic field tests as per IEC 61000-4-8

- External variable motor variac **VAR 3005A-S16**
- External magnetic field antenna **MFC 1000.x**
- External current transformer **MFT 30** to test 1, 3, 10 and 30 A/m levels (continuous)

2.2.5. Test setup with MFT 100 for H-Fields up to 1.000 A/m

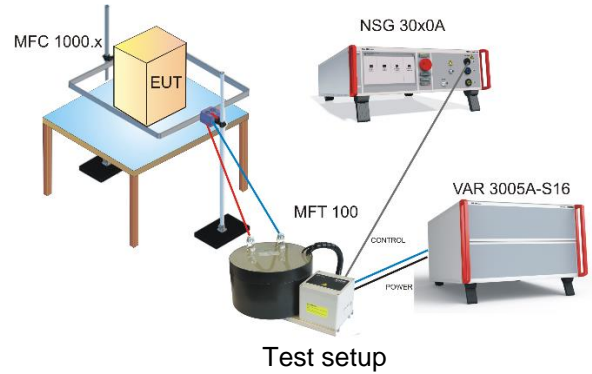
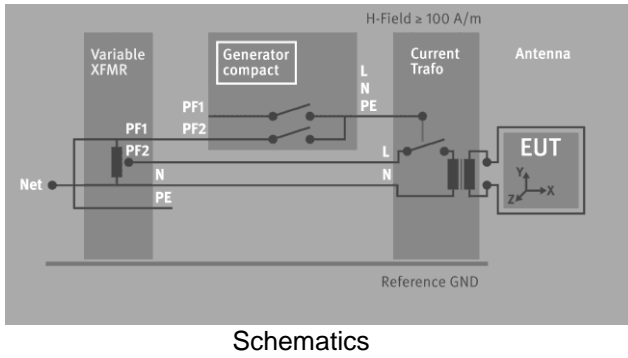

Schematics and Test setup with NSG 3040A, VAR 3005A-S16, MFT 100 and MFC 1000.1

Options required for magnetic field tests as per IEC 61000-4-8

- External variable motor variac **VAR 3005A-S16**
- External magnetic field antenna **MFC 1000.x**
- External current transformer **MFT 100** to test 100 A/m (continuous) and up to 1.000 A/m (short-term)

Tests with 1.000 A/m magnetic field

During tests with a field of 1.000 A/m the primary current of variac NX1-260-16 during the 3s testtime goes to approx. 39A. The motorvariac can withstand this load for this short time. The figure below shows the load diagram. Therefore the variac NX1-260-16 can withstand during approx. 45s a current of 39A. Normally the fuses do not break during the 3s test time.

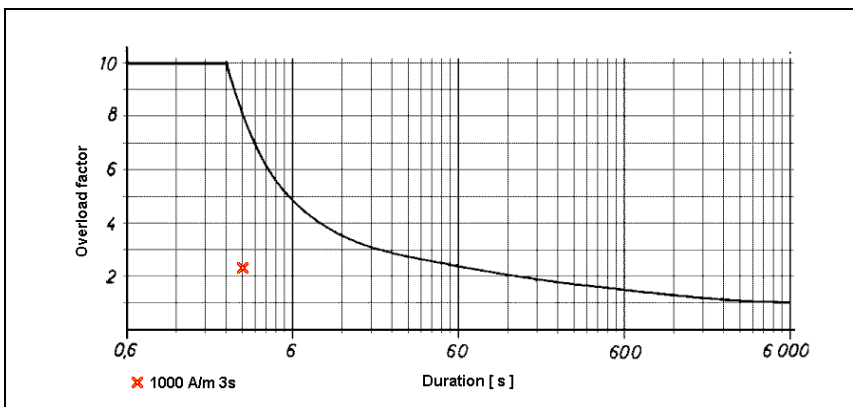

Load diagram variac NX1-260-16

2.3. Verification of the generator characteristic as per IEC 61000-4-8

The output current shall be measured with the coil connected. The connection to the antenna shall be made of drilled cables of max 3 m length and with a sufficient cross-section.

The characteristics to be verified are:

- current value in the standard inductive coils;
- field strength in all other inductive coils;
- total distortion factor in the inductive coils.

For standard inductive coils the verifications shall be carried out with a current probe and measurement instrumentation having better than $<\pm 2\%$ accuracy.

For all other inductive coils the verification should be carried out with field strength meter, having an $<\pm 1\text{dB}$ accuracy.

Field strenght [A/m]	Current values for the 1 m x 1 m standard coil I[A]
1	1.15
3	3.46
10	11.5
30	34.48
100	114.95
300	344.85
1000	1149.5

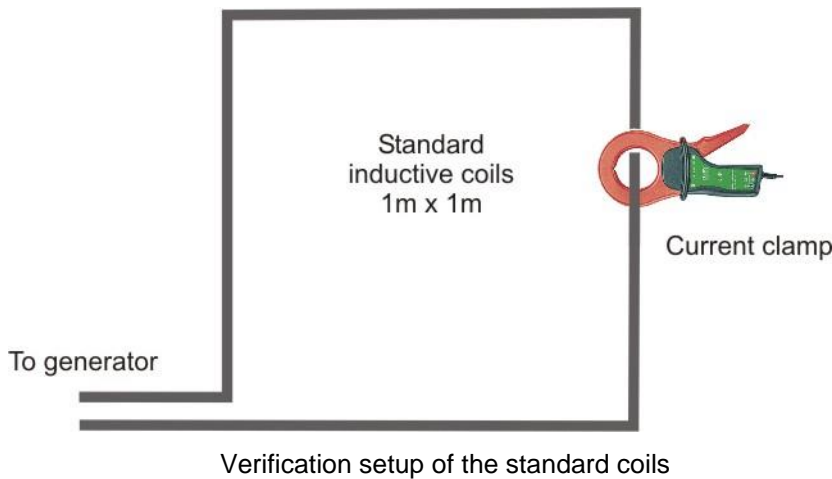

2.4. IEC 61000-4-9 Pulsed magnetic field with compact NX5/NX7



Main menu Magnetic Field separated to “Power frequency” and “Pulsed”

Select “Pulsed” to perform tests according IEC 61000-4-9.

2.4.1. Magnetic field as per IEC 61000-4-9

Pulse magnetic fields are generated by lightning strokes on buildings and other metal structures including aerial masts, earth conductors and earth networks and by initial fault transients in low, medium and high voltage electrical systems. In high voltage sub-stations, an impulse magnetic field may also be generated by the switching of high voltage bus-bars and lines by circuit breakers.

A surge generator as specified in IEC 61000-4-5 is used to generate a short circuit current with the wave shape of 8/20 μ s. The waveform used is defined in Figure 3 of IEC 61000-4-5.



Caution

**Only coils with 1 turn
can be used for pulsed magnetic field application.**

2.4.2. Pulsed Magnetic field operation

The menu offers different test routines for pulsed magnetic field testing.

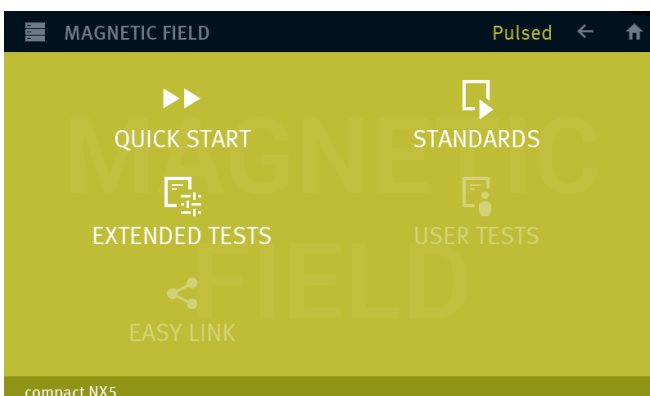

Main Menu Pulsed Magnetic Field

Quick Start

Easy and fast online-operation with the magnetic Surge phenomenon. In this menu the user can operate all test manually with online change the most parameters during a test.

Standard

The operator can select between various preprogrammed test routines as required in different standards. The standard library is filtered according to the EUT setting (AC, DC etc.)

Extended Tests

The operator can select between various preprogrammed test routines which helps to accelerate testing and which are very helpful especially during design.

User test routines

The user defined library where all created magnetic field tests are stored.

Easy Link

Link files library created during the actual session. The user can easy save a test into the Easy Link library. After switch off the Equipment all Easy Link tests are deleted. Use "SAVE AS USER TEST" for definitive save the test.

For magnetic field testing the antenna correction factor shall be included. The operator can enter this factor within the setup menu under the service routine.

2.4.3. Setup pulsed magnetic field



Warning

**Disconnect all power cables on the rear side at the Test supply plugs.
PF1, PF2 and N**

Don't touch the antenna during the test!

At the rear part of the generator **no EUT power supply shall be connected** to the sockets of PF1 or PF2. This power supply is directly short circuited by the connected antenna after pressing Test On.

Connect the antenna with a twisted cable (length < 300cm) with the HV & COM-output at the rear side of the generator. The standard IEC 61000-4-9 Ed2 (2016) requires mandatory an 18 µF capacitor, that is automatically internal switched in the circuit to output HV – COM:

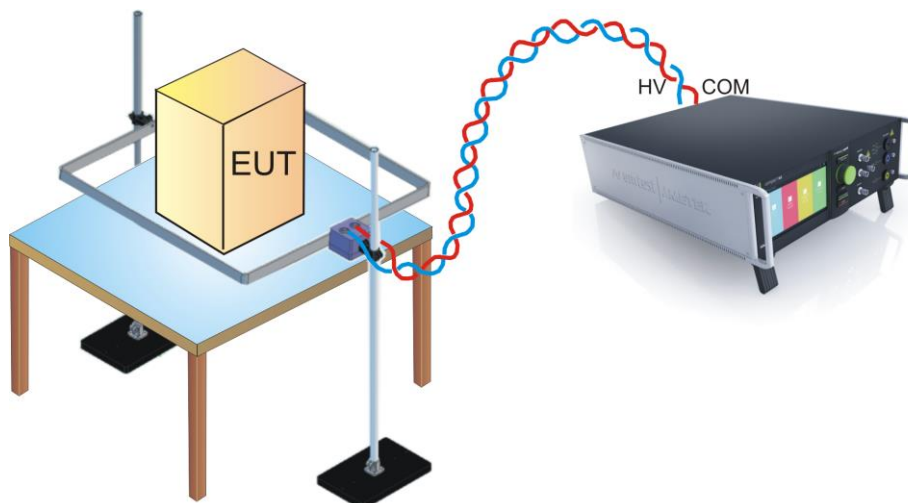
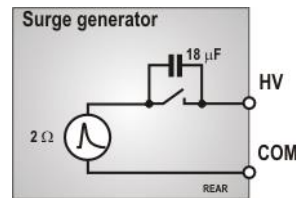
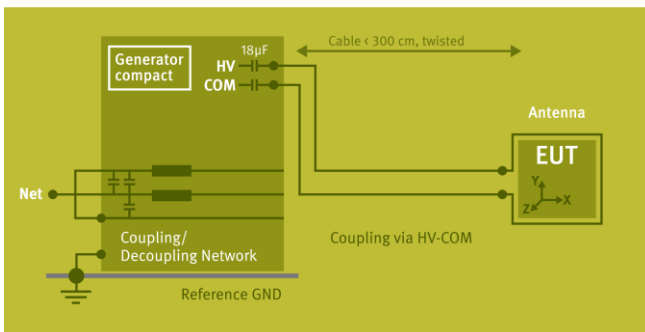

2.5. IEC 61000-4-9 Pulsed magnetic field with NSG 3040A/3060A

The menu offers different test routines for pulsed magnetic field testing.

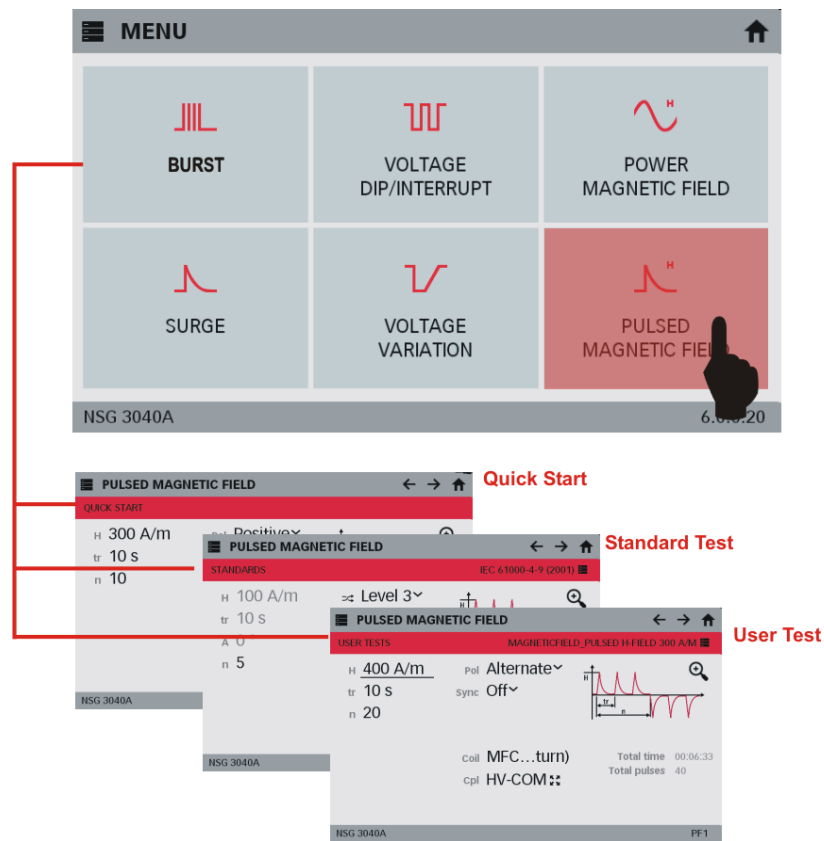

Main menu Pulsed Magnetic Field

The Magnetic Field menu offers different test routines for pulsed magnetic testing.

Quick Start

Easy and fast online-operation with the pulsed magnetic surge phenomenon. In this menu the user can operate all test manually with online change the most parameters during a test.

Standard

The operator can select between various preprogrammed test routines as required in different standards. The standard library is filtered according to the EUT setting (AC, DC etc.)

User test routines

The user defined library where all created magnetic field tests are stored.

For magnetic field testing the antenna correction factor shall be included. The operator can enter this factor within the setup menu under the service routine.

2.5.1. Quick Start

Easy and very fast operation of all standard functions of the equipment. The latest simulator settings are stored automatically and will be recalled when Quick Start is next selected.

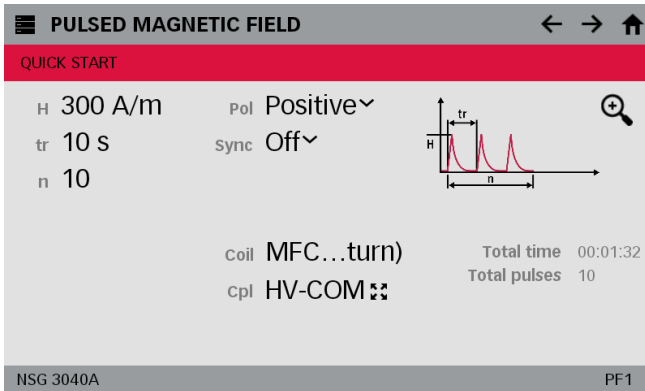

Quick Start Menu

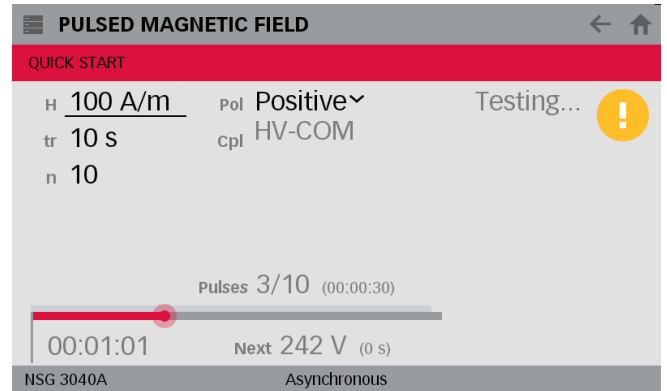

Quick Start testing for 100 A/m

2.5.2. Standard test Routine

The user can select preprogrammed standard test routines.

Change to
 - Quick Start
 - User Test

Other:
 - Add to STEPS
 - Configuration
 - Save as User
 - Load Defaults

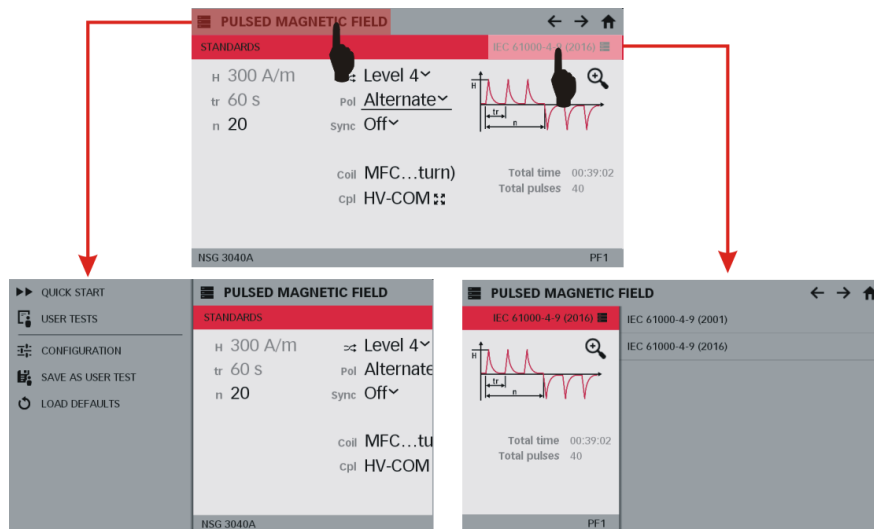

Change to Standard library

Within this test routine all standard parameters can be changed online during testing. For change tip to the black marked parameters

The user can easy select the following parameters

T (test duration): 1 s to 999 s (standard says **60 s** or faster depend on the protection devices power rate)

Level (voltage): Level 3 (100 A/m)
 Level 4 (300 A/m)
 Level 5 (1000 A/m)

Coupling (Cpl): **HV - COM** (to antenna)

2.5.2.1. Pulsed Magnetic Field Standard library

The pulsed magnetic field standard menu offers a list of standards of edition 1 (2001) and edition 2 (2016).

The standard name has the character: **[Standard Family], [Standard number], [year]**

The standard IEC 61000-4-9 Ed2 (2016) requires mandatory an 18 μF capacitor, that is automatically internal switched in the circuit to output HC – COM

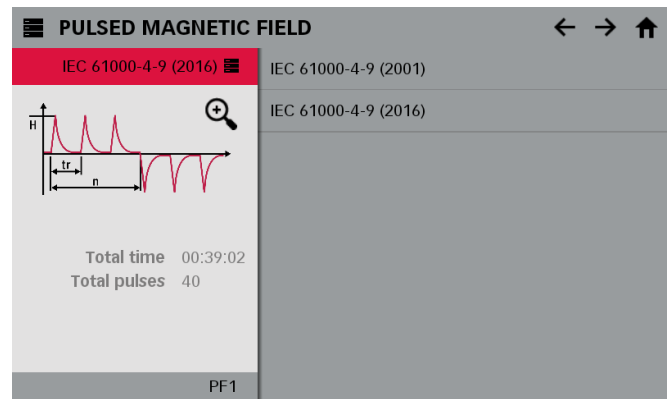
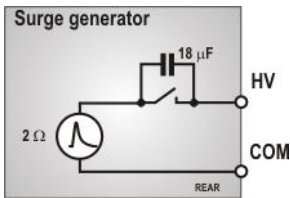

2.5.3. User Test Routines

The user can program, save and recall his own specific user test routines, created by himself.

The extended menu offers various useful tests for testing and development.

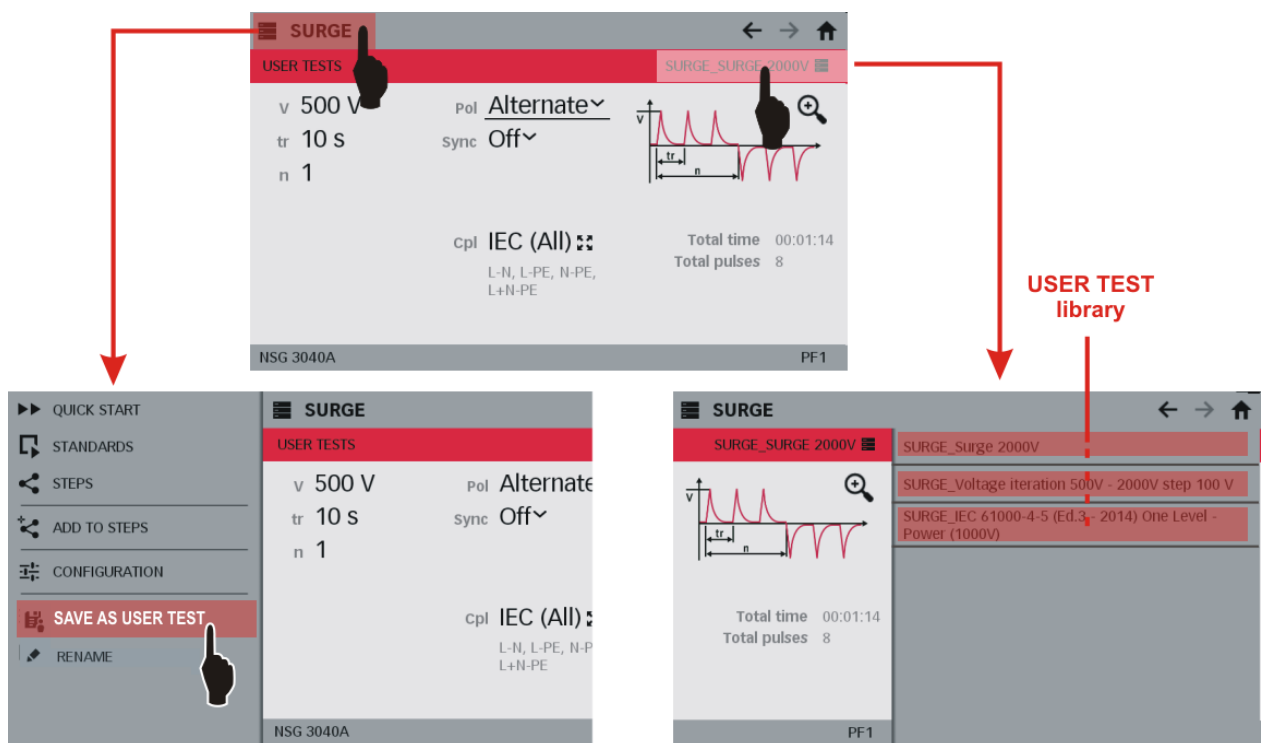

SAVE AS USER TEST Save the actual test as user test. The user defines the name of the test

2.5.4. Magnetic field as per IEC 61000-4-9

Pulse magnetic fields are generated by lightning strokes on buildings and other metal structures including aerial masts, earth conductors and earth networks and by initial fault transients in low, medium and high voltage electrical systems. In high voltage sub-stations, an impulse magnetic field may also be generated by the switching of high voltage bus-bars and lines by circuit breakers.

A surge generator as specified in IEC 61000-4-5 is used to generate a short circuit current with the wave shape of 8/20 μs . The waveform used is defined in Figure 3 of IEC 61000-4-5.



Caution

Only coils with 1 turn
can be used for pulsed magnetic field application.

2.5.5. Setup pulsed magnetic field



Warning

Disconnect all power cables on the rear side at the Test supply plugs.
PF1, PF2 and N
Don't touch the antenna during the test!

At the rear part of the generator **no EUT power supply shall be connected** to the sockets of PF1 or PF2. This power supply is directly short circuited by the connected antenna after pressing Test On.

Connect the antenna with a twisted cable (length < 300cm) with the HV & COM-output at the rear side of the generator. The standard IEC 61000-4-9 Ed2 (2016) requires mandatory an 18 μF capacitor, that is automatically internal switched in the circuit to output HV – COM:

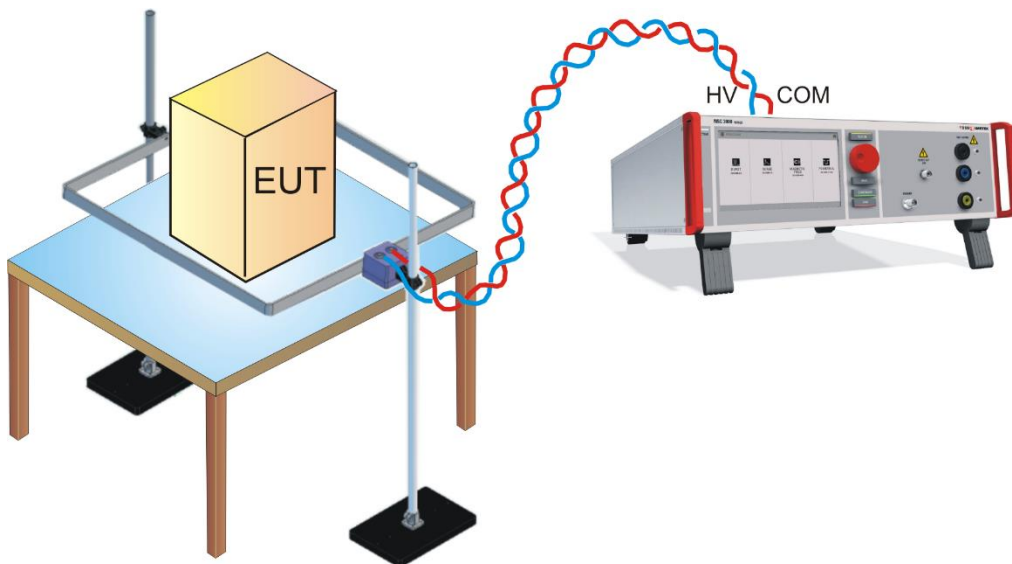
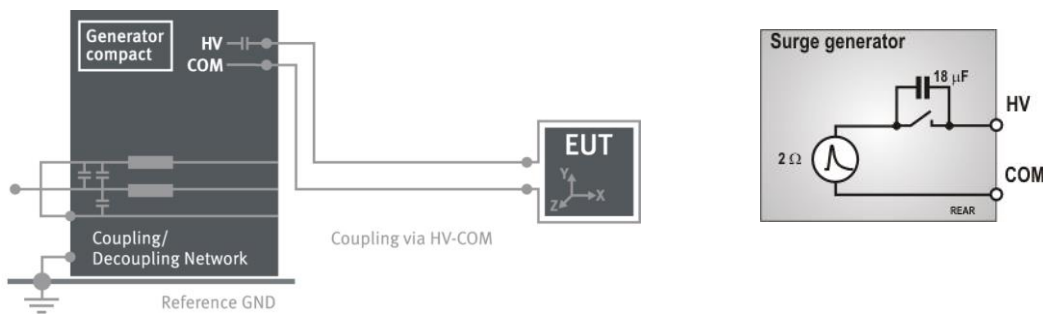

2.6. IEC 61000-4-10 Damped Magnetic Field

This part is realized with the OCS500N6/N6F generator.

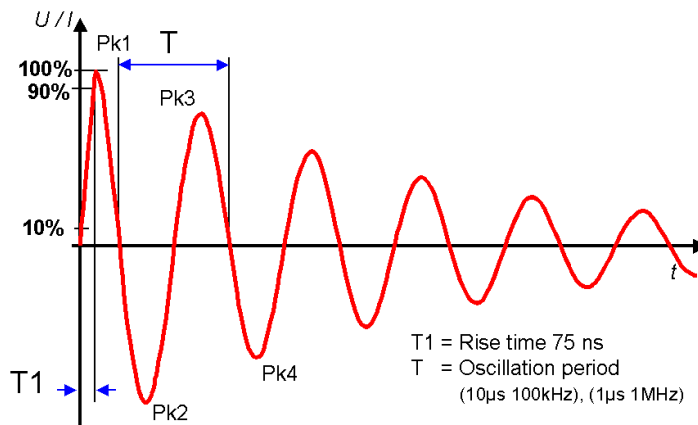

Characteristic of the generator (Damped Oscillatory Magnetic Field)

The generator is specified as per IEC 61000-4-10 and the antenna is connected to the output HV - COM

Currents as follows:

Mode	Burst mode, duration 2s with at least 40 Hz pulse rep rate
Current range	10A ... 100A (setting with respect to the coil factor)
Current wave shape	100kHz damped oscillatory as per IEC 61000-4-10

Mode	Burst mode, duration 2s with at least 400 Hz pulse rep rate
Current range	10A ... 100A (setting with respect to the coil factor)
Current wave shape	1MHz damped oscillatory as per IEC 61000-4-10

Verification of the generator characteristic

The output current shall be verified with the generator connected to the standard induction coil. The connection shall be realized by twisted conductors or coaxial cable of up to 3 m length and suitable cross-section.

The short circuit output current shall be measured. The parameters to be verified are:

- Current peak value
- Damping
- Oscillation frequency

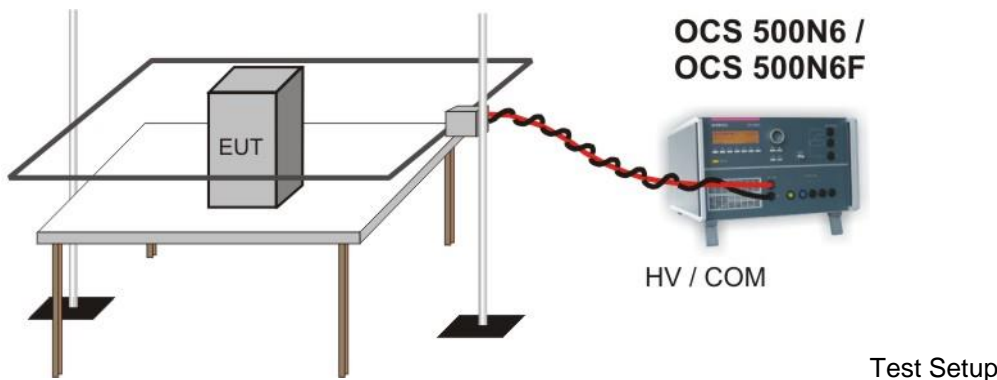

3. Technical data

Magnetic field antenna	MFC 1000 , 1 m x 1 m	MFC 1000.1 , 1 m x 1 m
Number of turns	1, (single turn)	1, (single turn)
Antenna factor	0,87/m	0,87/m
Nominal current	8/20 μ s pulse current up to 2.000 A 50/60 Hz AC current continuous 250 A/m short time for 3 s 1.200 A	8/20 μ s pulse current up to 2.000 A 50/60 Hz AC current continuous 250 A/m short time for 3 s 1.200 A
Connectors	Safety laboratory plugs 4mm continuous ac currents up to 32A/ plug 3.2kA (8/20 μ s pulse current) High current plugs continuous ac current > 30A to 250A short time currents 3 s up to 1500A	M14 screws cont. ac current > 30A to 250A short time currents 3s up to 1500A
Construction	Double stand for MFC 1000 coil with base on casters with brakes; rotation mechanism with 3 position brakes. turntable for horizontal and vertical fields	Height adjustable and coil 360 degrees rotatable; double stand turntable for horizontal and vertical fields
Material	Aluminium, 4cm ² cross section	Aluminium, 4cm ² cross section
Weight	15,5 kg	15.5 kg
50/60Hz magnetic field Variac	variatic NX1-260-16, 0-260 V/16 A variatic NX1-280-16, 0-280 V/16 A VAR 3005A-S16, 0-260 V/16 A Manual variac 0-260 V, 5 A (for magnetic fields up to 100 A)	
Line voltage variac NX1-2x0-16	230V 16A	(for H-field 1.000 A/m: max. 39A for 3s)
Current transformer (30 A/m)	Type MFT 30	
Input voltage	0 – 250 V rms	
Output current	0 – 50 A rms	
Weight	5,50 kg Transformer 0,35 kg 4 Safety labor cables 2m	
Dimension	260 x 180 x 100 mm ³	
Current transformer (1.000 A/m)	Type MFT 100	
Input voltage	0 – 250 V rms	
Output current (Transformator)	0 – 250 A rms continuous transformator secondary max. 1.200 A for 3 s (approx. 600 A for 115 V line power) 200 A rms continuous (cable connection MFT 100 – MFC 1000.x with 50mm ²)	
Connector	male: Multicontact KST 14AR-N/50 female: Multicontact KBT 14AR-N/50	200 A cont, 3 kA 3s 200 A cont, 3 kA 3s
Weight	26,45 kg Transformer 2,0 kg Cable 2 units 0,25 kg Mains cable	
Dimension	260 x 380 x 200 mm ³	
Waveform	Sinewave	
Pulsed magnetic field Mode	using a compact NX5/NX7, NSG 30x0A Single pulse, max. repetition rate 10 s	
Current range	100...2.000 A (multiplied with antenna factor)	
Current wave shape	8/20 μ s current pulse as per IEC 1000-4-5	
Polarity	Positive and negative	
Synchronization	0 - 360° in steps of 10°	

4. Standards

Magnetic field tests are specified in three different standards, depending on the kind of phenomena which shall be simulated.

IEC 61000-4-8	IEC 61000-4-9	IEC 61000-4-10
50/60Hz magnetic field	pulsed magnetic field	Damped oscillatory magnetic field

4.1. IEC 61000-4-8

In IEC 61000-4-8 the test procedure for power frequency magnetic field test (50 Hz/60 Hz) is specified. The devices under test are mostly systems which may be influenced by such fields, as monitors and hall sensors or high-resolution graphical displays. Extreme field strengths are generated near to railway installations or near to substations or power plants.

Continuous field		Short duration: 1 s to 3 s	
Level	Magnetic field strength [A/m]	Level	Magnetic field strength [A/m]
1	1	1	-----
2	3	2	-----
3	10	3	-----
4	30	4	300
5	100	5	1000
x	special	x	special

Antenna current

According IEC 61000-4-8 the standard defines a fix current for the given antenna loop 1m x 1m for each test level.

H Field [A/m]	1m x 1m antenna
1	1.15A
3	3.45A
10	11.5A
30	34.48A
100	114.95A

4.2. IEC 61000-4-9

Pulsed magnetic fields are measured in the field due to the effect of direct lightning to buildings and structures of electrical/industrial installations. The magnetic field strength ranges from a few hundred A/m (peak) up to several kA/m (peak) in the proximity of earth conductors.

Level	Magnetic field strength [A/m]
1	-----
2	-----
3	100
4	300
5	1000
x	special

4.3. IEC 61000-4-10

Damped oscillatory fields mainly are related by operation of high voltage bus-bar isolators. Field strength of up to several 100 A/m can be detected.

Damped oscillatory

Level	Magnetic field strength [A/m]
1	-----
2	-----
3	10
4	30
5	100
x	Special

Two different oscillation frequencies are required:

- 100 kHz with a repetition rate of at least 40 Hz
- 1 MHz with a repetition rate of at least 400 Hz

Damped Oscillatory Generator (OCS 500N6)

100 kHz and 1 MHz oscillation frequency of max. 2,5kV peak voltage. The test pulses are coupled to the lines via coupling/decoupling networks. The minimum repetition rate is at least 40 Hz (100 kHz) and 400 Hz (1 MHz).

4.4. Application of IEC 61000-4-8 and 9

Application:	Level
CE residential, commercial and light industry:	3 A/m
CE industry:	30 A/m
Railway appliances:	30 A/m
Power stations:	100 A/m

5. Maintenance and service

5.1. General

The transformers and antenna are absolutely maintenance-free.

5.2. Calibration and Verification

5.2.1. Factory calibration

AMETEK CTS equipment is entirely checked and calibrated as per international standard regulations before delivery. A calibration certificate is issued and delivered along with a list of the equipment used for the calibration proving the traceability of the measuring equipment. All auxiliary equipment and accessories are checked to our internal manufacturer guidelines.

The calibration certificate and the certificate of compliance (if available) show the date of calibration.

The AMETEK CTS equipment is calibrated in the factory and marked with a calibration mark. The used measuring instruments are traceable to the Swiss Federal Office of Metrology.

The calibration date is marked. The validity of the calibration is to the responsibility of the user's quality system. Neither the certificate of calibration nor the corresponding label marks any due date for re-calibration.



Example: Calibration mark

5.2.2. Guideline to determine the calibration period of AMETEK CTS instrumentation

Our International Service Departments and our QA Manager are frequently asked about the calibration interval of AMETEK CTS equipment.

AMETEK CTS doesn't know each customer's Quality Assurance Policy, nor do we know how often the equipment is used and what kind of tests are performed during the life cycle of a test equipment. Only the customer knows all the details and therefore the customer needs to specify the calibration interval for his test equipment.

In reply to all these questions we like to approach this issue as follows:

AMETEK CTS make use of a solid-state semiconductor switch technique to generate high voltage transients. A precious advantage of this technique is the absolute lack of periodical maintenance effort. In consequence thereof a useful calibration period has to be defined based on two criteria:

- The first one is the customer's Quality Assurance Policy. Any existent internal regulation has to be applied at highest priority. In the absence of such internal regulation the utilization rate of the test equipment has to be taken into consideration.
- Based on the experience and observation collected over the years **AMETEK CTS recommend a calibration interval of 1 year** for frequently used equipment. A 2-years calibration interval is considered sufficient for rarely used test generators in order to assure proper performance and compliance to the standard specifications.

5.2.3. Calibration of Accessories made by passive components only:

Passive components do not change their technical specification during storage. Consequently, the measured values and the plots stay valid throughout the storage time. The date of shipment shall be considered as the date of calibration.

5.2.4. Periodically In-house verification

Please refer to the corresponding standard before carrying out a calibration or verification. The standard describes the procedure, the tolerances and the the necessary auxiliary means. Suitable calibration adapters are needed. To compare the verification results, AMETEK CTS suggests referring to the waveshape and values of the original calibration certificate.

All calibrations and verifications are always done without mains supply voltage connected to the coupling network input.



Danger

Before starting the calibration or verification
remove the EUT Mains Supply
from the generator and from the coupling network

5.3. Maintenance

The antenna and power transformers are maintenance-free.

5.3.1. Cleaning

Never scratch objects or caustic chemicals for cleaning. The housing with a soft moist cloth, wipe and dry them afterwards.

6. Delivery groups

Identical accessory parts are delivered only once if several devices are ordered. The delivered packing list is in each case valid for the delivery.

6.1. Antenna MFC 1000.x

- H field antenne (mast and coil must be built together)
 - included contact to MFT 30
 - optional contact to MFT 100 when ordered
- UserManual-MFC1000_MFT30-100-E Vx.xx

6.2. MFT 30 Magnetic field transformer

- H-field transformer MFT 30
- 2 safety lab cables 2m black
- 2 safety lab cables 2m blue

6.3. MFT 100 Magnetic field transformer

- H-field transformer MFT 100
- 2 x 1.5m power cable incl plug male for MFC 1000.x (if not delivered with MFC 1000.x)
- 2 safety lab cables 2m 1x black 1x blue (if no MFT 30 is delivered)
- 1 power cable (230V)

7. Appendix

7.1. Declaration of CE-Conformity

Manufacturer : **AMETEK CTS GmbH**
 Address: Sternenhofstr. 15
 CH 4153 Reinach
 Switzerland

declares, that under its sole responsibility, the product's listed below, including all their options, are conformity with the applicable CE directives listed below using the relevant section of the following EC standards and other normative documents.

Product's name: Magnetic field test equipment
 Model Number(s) MFC 1000, MFC 1000.1
 MFT 30
 MFT 100

Low Voltage Directive 2014/35/EU

Standard to which conformity is declared:

EN 61010-1 : 2011 Safety requirements for electrical equipment for measurement, control, and laboratory use.

EMC Directive 2014/30/EU

Standard(s) to which conformity is declared:

EN 61326-1 : 2013 Electrical equipment for measurement, control and laboratory use Class A
 EN 61000-3-2 : 2014 Limits for harmonic current emissions
 EN 61000-3-3 : 2013 Limitation of voltage changes, voltage fluctuations and flicker in public low-voltage supply systems.

Manufacturer
 AMETEK CTS GmbH
 Sternenhofstr. 15
 CH 4153 Reinach
 Phone: +41 61 204 41 11
 Fax: +41 61 204 41 00



By A. Burger
 Director Engineering AMETEK CTS
 Place Reinach BL, Switzerland
 Date 01. August 2019