



SYSTEM FOR MAGNETIC FIELD TESTING IN THE CLOSE PROXIMITY NSG 4070C1/C2-LFCP

USER MANUAL



SYSTEM FOR MAGNETIC FIELD TESTING IN THE CLOSE PROXIMITY NSG 4070C1/C2-LFCP

USER MANUAL

This manual is written for NSG 4070C1/C2-LFCP. It is based on firmware version 1.0.

CONTENT

1.	Safety advice	7
1.1.	Safety and warning symbols	7
1.2.	Safety Aspects	8
1.3.	Connection to the mains and PE	8
1.4.	Connections to other ports with dangerous voltages (AE, EUT, RF port ...)	8
1.5.	Connection to the ground plane or Faraday cage	8
1.6.	Disconnection from the mains, PE, ground and control devices.....	9
1.7.	Use proper fuses	9
1.8.	Risk of electric shock.....	9
1.9.	Operating Environment	9
1.10.	Test execution	10
1.11.	Dangers concerning the generator.....	10
1.12.	Dangers concerning the EUT	10
1.13.	Applicable safety standards.....	10
1.14.	Intended use	11
1.15.	Warranty Terms	11
1.16.	Prohibition of unauthorized conversions and modifications.....	11
1.17.	Specific accessories required for safety reason	11
1.18.	Procedure in case of hazard	11
1.19.	Cautions on handling the power meters.....	12
2.	Unpacking, storage and transport	13
2.1.	General.....	13
2.2.	Storage and transport	13
2.3.	Unpacking	13
2.4.	Scope of delivery	13
3.	Description of the instrument.....	14
3.1.	General.....	14
3.2.	Operating elements.....	15
3.2.1.	Front panel.....	15
3.2.2.	Back panel.....	19
4.	Explanation of the menu-controlled operation	21
4.1.	General.....	21
4.1.1.	Menu control with softkeys and hardkeys	21
4.1.2.	Help function ("HELP").....	21
4.1.3.	Numerical input using the numerical keyboard.....	21
4.1.4.	Secondary functions.....	21
4.1.5.	Level setting, frequency setting, modulation setting and tuning.....	21
4.1.5.1.	Level setting	21
4.1.5.2.	Frequency setting.....	21
4.1.5.3.	Modulation setting.....	21
4.1.5.4.	Tuning using the rotary knob	21
4.1.6.	Saving and loading of configurations and results	22
4.1.6.1.	General.....	22
4.1.6.2.	Store	22
4.1.6.3.	Recall	22
4.2.	Main menu	23
4.3.	Setup	23
4.3.1.	Setup → General	23
4.3.1.1.	Setup → General → Language setup.....	24
4.3.1.2.	Setup → General → Color theme setup	24
4.3.1.3.	Setup → General → System time & date setup	24

4.3.2.	Setup → Remote control setup	25
4.3.2.1.	Setup → Remote control setup → Remote interface setup	25
4.3.2.2.	Setup → Remote control setup → TCP/IP Network interface setup	26
4.3.2.3.	Setup → Remote control setup → Serial interface setup	26
4.3.3.	Setup → Power limitations	27
4.3.4.	Setup → Directional coupler	27
4.3.5.	Setup → Service	28
4.4.	Power meter menu	29
4.5.	Immunity menu	30
4.5.1.	Immunity menu: Recall configurations	30
4.5.2.	Immunity menu → Main	31
4.5.3.	Immunity menu → Test Setup	31
4.5.3.1.	Immunity menu → Test setup → Test level	31
4.5.3.2.	Immunity menu → Test setup → Loop type	32
4.5.3.3.	Immunity menu → Test setup → Amplifier	32
4.5.3.4.	Immunity menu → Test setup → Sweep	32
4.5.3.5.	Immunity menu → Test setup → Modulation	35
4.5.4.	Immunity menu → Monitoring setup	36
4.6.	Calibration	37
4.6.1.	Immunity menu: Recall the loop calibration data (receiving loop)	37
4.6.2.	Immunity menu: Recall probe calibration data	39
4.6.3.	Immunity menu → Calibration	41
4.6.3.1.	Immunity menu → Calibration → System calibration	41
4.6.3.2.	Immunity menu → Calibration → Saturation check	42
4.6.3.3.	Immunity menu → Calibration → Probe calibration	43
4.6.3.4.	Immunity menu: Store and recall system calibration data	44
4.6.3.5.	Immunity menu: Store probe calibration data	45
4.6.4.	Immunity menu → Results	46
4.6.5.	Immunity menu: Testing	46
4.6.5.1.	Immunity menu: Testing with EUT monitoring events	47
4.6.5.2.	Immunity menu: Testing with manual change of frequency and level	48
4.6.5.3.	Immunity menu: Store and recall results	49
4.6.5.4.	Immunity menu: Store configurations	51
4.7.	Generator menu	52
4.7.1.	Generator menu → Modulation	53
4.7.2.	Generator menu → Sweep	53
4.7.3.	Generator menu → Amplifier	54
4.8.	Device info	55
4.8.1.	Info → Update firmware	55
5.	Remote control commands	56
5.1.	Common commands	56
5.1.1.	*IDN?	56
5.1.2.	*GTL	56
5.1.3.	*RST	56
5.2.	The SOURce subsystem	56
5.2.1.	Set fixed frequency (SOURce:FREQuency:FIXed CW)	56
5.2.2.	Set fixed level (SOURce:POWer:LEVel:AMPLitude)	56
5.2.3.	Output On/Off (SOURce:POWer:LEVel:STATe)	56
5.2.4.	Sweep parameters	57
5.2.5.	Modulation parameters (SOURce:MODulation)	59
5.3.	The power meter subsystem	60
5.3.1.	Channel 1 (POWERmeter:CHannel1?)	60
5.3.2.	Channel 2 (POWERmeter:CHannel2?)	60

5.3.3.	Channel 3 (POWERmeter:CHannel3?).....	60
5.3.4.	Forward power (POWERmeter:FORWARD?)	60
5.4.	The amplifier subsystem	60
5.4.1.	Amplifier On / Off (AMPLifier).....	60
5.5.	The monitor subsystem.....	60
5.5.1.	Analog input (MONitor:ANALog?)	60
5.5.2.	Digital input (MONitor:DIGital?)	61
5.5.3.	Digital outputs.....	61
5.6.	The MISCellaneous subsystem	62
5.6.1.	File information.....	62
5.7.	The Service subsystem.....	63
6.	Establishing the remote connection.....	64
7.	Advanced use of EUT monitoring ports.....	66
7.1.	Digital outputs.....	66
7.1.1.	“Auto” mode	66
7.1.2.	Monitoring event	66
7.1.3.	Frequency step.....	66
7.1.4.	Switching at a defined frequency	67
7.1.5.	Switching at test start.....	67
8.	Application and standard requirements.....	68
8.1.	Frequency range 9 kHz to 150 kHz.....	68
8.1.1.	Test level setting.....	68
8.1.2.	Testing.....	70
8.1.3.	Influence of the distance on the magnetic field strength	71
8.1.4.	Expected correlations for selected test levels	72
8.1.5.	Power requirements.....	74
8.1.6.	Modulation	75
8.1.7.	Saturation check.....	75
8.1.8.	Current probe	75
8.1.9.	Calibration jig.....	75
8.1.10.	Probe calibration	76
8.1.11.	Power meter	76
8.1.12.	Attenuator.....	76
8.1.13.	Optically decoupled remote control	76
8.1.14.	Test facility	76
8.2.	Frequency range 150 kHz to 26 MHz.....	77
8.2.1.	Test level setting for the whole frequency range	77
8.2.2.	Test level setting for the frequency 13.56 MHz with ANP 4039	78
8.2.3.	Testing for the whole frequency range	79
8.2.4.	Testing for the frequency 13.56 MHz with ANP 4039	80
8.2.5.	Influence of the distance on the magnetic field strength	81
8.2.6.	Test levels	82
8.2.7.	Power requirements.....	86
8.2.8.	Pulse modulation.....	87
8.2.9.	Power meter	87
8.2.10.	Optically decoupled remote control	87
8.2.11.	Test facility	87
9.	Technical specifications	88
9.1.	Generator	88
9.2.	Power meter	88
9.3.	Power amplifier.....	89
9.4.	Test and measurement routines	90
9.4.1.	Generator mode	90

9.4.2.	Power meter mode.....	90
9.4.3.	Immunity mode.....	90
9.5.	Analog ports.....	91
9.6.	Digital ports.....	91
9.7.	Power supply.....	91
9.8.	General data.....	92
9.9.	Mechanical specifications.....	92
10.	Troubleshooting.....	93
10.1.	Procedure to check the function of the power meters.....	96
11.	Maintenance.....	97
11.1.	General.....	97
11.2.	Cleaning.....	97
12.	Disposal.....	97

FIGURES

Figure 1:	Block diagram of NSG 4070C1/C2-LFCP.....	14
Figure 2:	Front view of NSG 4070.....	15
Figure 3:	Back view of NSG 4070.....	19
Figure 4:	Timing of User port D0 output in "auto" mode.....	66
Figure 5:	Set up example for test level setting.....	68
Figure 6:	Example for test level setting.....	69
Figure 7:	Set up example for testing.....	70
Figure 8:	Example for typical power requirements using NSG 4070C1/C2-LFCP.....	74
Figure 9:	Amplitude modulation.....	75
Figure 10:	Probe calibration setup.....	76
Figure 11:	Set up example for test level setting for the whole frequency range.....	77
Figure 12:	Set up example for test level setting for the frequency 13.56 MHz with ANP 4039.....	78
Figure 13:	Set up example for testing.....	79
Figure 14:	Set up example for testing the frequency 13.56 MHz with ANP 4039.....	80
Figure 15:	Example for typical power requirements using NSG 4070C1/C2-LFCP.....	86
Figure 16:	Pulse modulation.....	87

TABLES

Table 1:	Example of a result in the ".csv" format.....	50
Table 2:	Common commands.....	56
Table 3:	Sweep status byte.....	57
Table 4:	Digital monitoring inputs.....	61
Table 5:	Calculated field strength deviation in relation to the distance.....	71
Table 6:	Expected correlations for test level 1 A/m.....	72
Table 7:	Expected correlations for test level 3 A/m.....	72
Table 8:	Expected correlations for test level 10 A/m.....	73
Table 9:	Expected correlations for test level 30 A/m.....	73
Table 10:	Expected correlations for test level 8 A/m at 30 kHz and 65 A/m at 134.2 kHz.....	74
Table 11:	Calculated field strength deviation in relation to the distance.....	81
Table 12:	Expected correlations for test level 0.1 A/m.....	82
Table 13:	Expected correlations for test level 0.3 A/m.....	83
Table 14:	Expected correlations for test level 1 A/m.....	84
Table 15:	Expected correlations for test level 3 A/m.....	85
Table 16:	Expected correlations for test level 7.5 A/m with connected ANP 4039.....	86







1. SAFETY ADVICE



Observe all precautions to assure your personal safety. Read the user manual carefully. Pay special attention to safety and operation details!

1.1. Safety and warning symbols

Please take note of the following explanations of the symbols used in order to achieve the optimum benefit from this manual and to ensure safety during operation of the equipment.

	This symbol warns of a potential risk of shock hazard. Use standard safety precautions to avoid personal contact with these voltages.
	This symbol indicates where a caution is required. Refer to the operating instructions located in the manual in order to protect against personal injury or damage the equipment. It calls attention to a procedure, practice or condition which, if not followed, could possibly cause damage to equipment. Such damage may invalidate the warranty. Do not proceed until its conditions are fully understood and met.
	This symbol indicates non-ionizing radiation. Non-ionizing radiation may pose a health hazard to operators. Protective measures such as switching off the RF before entering the Faraday cage, level limitation and/or spatial distance are common measures.
	This symbol indicates access of persons with pacemakers prohibited.
	This symbol indicates the ground terminal.
	This symbol indicates the protective earth terminal.

1.2. Safety Aspects

These operating instructions form an integral part of the equipment and must be available to the operating personnel at all times. The user must obey all safety instructions and warnings.

Neither AMETEK CTS Europe GmbH nor any of its subsidiary sales organizations can accept any responsibility for personal, material or consequential injury, loss or damage that results from improper use of the equipment and accessories.



WARNING

Improper or careless handling can be fatal!
Use of the generator is restricted to authorized and trained specialists

1.3. Connection to the mains and PE

- ▶ The instrument conforms to protection class 1. Operation without a protective earth connection is forbidden!
- ▶ Before switching on the device, check whether the selected voltage matches the supply voltage. The position of the voltage selector must correspond with the mains. If you change the mains voltage, replace the fuses according to the recommended value.
- ▶ A proper protective earth connection through the connector of the power cord is essential for safe operation.
- ▶ High leakage currents can cause the residual current circuit breaker of the mains to trip. In this case, the use of an isolating transformer is required.
- ▶ Handle the power cord carefully. Hold the plug when unplugging the cord.
- ▶ Never use the product if the power cord or the plug is damaged.
- ▶ Use only power cords and connector specified for your product.
- ▶ Do not abuse the cord. Never use the cord for carrying, pulling or unplugging the unit. Keep cord away from heat, oil, sharp edges or moving parts.
- ▶ Prevent the device from being switched on or energized unintentionally. Make sure that the switch is in the off position before connecting the device to the mains.
- ▶ Disconnect the power plug if you are not going to use the device for a long period of time.

1.4. Connections to other ports with dangerous voltages (AE, EUT, RF port ...)

- ▶ Only use the connection cables and plugs specified for your product which enable safe working. They must comply with the required classification and have suitable voltage and current ratings for the application.
- ▶ Handle the connection cable carefully. Hold the plug when unplugging the cable.
- ▶ Never use the product if the connection cable or plug is damaged.
- ▶ Avoid touching conductive parts unless they have been de-energized by suitable means and secured against being switched on again for the period of handling. Industrial connectors often have insufficient protection against electric shock due to their application.

1.5. Connection to the ground plane or Faraday cage

- ▶ Remove the protective foil from under the device and adapter housing to ensure good electrical contact.
- ▶ Light equipment should be weighted down, clamped to the base plate or other measures should be taken to ensure good electrical contact over a wide surface area and on a permanent basis.



- ▶ Connect the device with the ground plane before using.
- ▶ The operation without a second, only with a tool removable earth leakage connection is prohibited.
- ▶ Check the ground connection at regular intervals.

- ▶ Ensure that a reliable return path for the interference current is provided between the equipment under test (EUT) and the generator. The reference ground plane and the earth connections to the instrument as described in the relevant test standard serve this purpose well.

1.6. Disconnection from the mains, PE, ground and control devices

- ▶ Always set the power switch to the "Off" position and wait few seconds before disconnecting the power cord.
- ▶ Disconnect the power cord and all connection cords when moving the unit.

1.7. Use proper fuses

- ▶ To avoid fire hazard, use only fuses as specified in the parts listing for your product - matching type, voltage and current rating.

1.8. Risk of electric shock



WARNING

- ▶ To reduce the risk of electric shock, do not remove parts from the housing.
- ▶ There are no user serviceable parts inside the unit. Certain parts inside the instrument work at mains voltage or at high frequency and are not provided with any protection against being touched.
- ▶ Only approved accessory items, connectors, adapters, etc. are to be used to ensure safe operation.



WARNING

- ▶ Not all lines, especially EUT supply lines, inside the device are protected by a fuse. Therefore, the user must implement the protection of the device against short-circuits by means of suitable fuses / circuit breakers.
- ▶ Avoid an overload by taking suitable precautions.
- ▶ In the event of a fault, dangerous and unexpected voltages may occur. Avoid touching conductive parts unless they have been de-energized by suitable means and secured against being switched on again for the period of handling.

1.9. Operating Environment

- ▶ Operate the equipment only in dry surroundings. Allow any condensation that occurs to evaporate before putting the instrument into operation. Do not exceed the permissible ambient temperature, humidity or altitude above sea level. Operate the unit not in explosive surroundings.
- ▶ No objects filled with liquids, such as coffee cups, shall be placed on the unit.
- ▶ Do not insert foreign objects in the ventilation holes.
- ▶ Do not obstruct the ventilation holes (also on the underside). Ventilation should not be impeded by covering the ventilation openings with items or other equipment.
- ▶ Avoid high temperatures. Allow for sufficient heat dispersion when installed in a rack. Do not place the product on radiators or fan heaters. The ambient temperature must not exceed the maximum specified temperature of this product.
- ▶ Keep the test area clean and well lit. Cluttered or dark areas invite accidents.

1.10. Test execution

- ▶ Check once again that all connections are proper including the ground and protective earth.
- ▶ Remove any adjusting key or wrench before switching on or energizing the device.
- ▶ The test area must be organized that no unauthorized persons have access during execution of a test.
- ▶ Operating the product requires special training and intense concentration. Make certain that persons who use the products are physically, mentally and emotionally fit enough to operate the products; otherwise injuries or material damage may occur.
- ▶ EUTs together with all accessories and cables are to be regarded as being live during the execution of a test.
- ▶ The safety instructions concerning all the instruments and associated equipment involved in the test setup are to be observed.
- ▶ The configuration of the test setup is to be strictly in compliance with the methods described in the relevant standard to ensure that the test is executed in a compliant manner.
- ▶ Working with high voltages alone is dangerous and prohibited by law.
- ▶ The high voltages must be switched off when nobody is present.

1.11. Dangers concerning the generator

- ▶ Local regulations for the protection of radio services must be observed. The interference generated by the generator can cause both conducted and radiated interference.
- ▶ If the radiated energy exceeds the permissible level, a shielded chamber with filtering of the supply lines or similar must be used. Decisive for the measures are the used levels, the geometry of the setup, the frequency range and the distance to the neighbor.
- ▶ Depending on the level used, the effectiveness of the connected antenna, TEM cell or similar, fields can be generated using appropriate power amplifiers, from which the operating personnel must be protected by suitable measures.
- ▶ Localized burning, arcing or ignition of explosive gases.
- ▶ Disruption of unrelated electronic, telecommunications or navigational installations or heart pacemakers through intentional and unintentional radiation of RF energy.



WARNING

Persons fitted with a heart pacemaker must not operate the instrument nor approach the test setup while it is in operation.

1.12. Dangers concerning the EUT

- ▶ EUTs are frequently simply functional samples that have not previously been subjected to any safety tests. Therefore, in some cases, the EUT is quickly damaged through internal overloads caused by the control electronics being disrupted. The EUT may even begin to burn.
- ▶ As soon as the EUT shows signs of damage the test should be stopped and the equipment under test should be switched off.
- ▶ Possible erroneous behavior by the EUT for example, a robotic device may misbehave, or a temperature regulator may fail.
- ▶ Even when power is off, capacitors may retain an electrical charge.

1.13. Applicable safety standards

- ▶ Development and manufacture of the instrument complies with ISO 9001.
- ▶ The equipment conforms with the essential requirements of the Low Voltage Directive (LVD) 2014/35/EU based on DIN EN 61010-1.

1.14. Intended use



The purpose of this instrument is the generation of defined interferences signals for EMI immunity testing. Depending on the test stand layout, configuration, wiring, and the characteristics of the EUT itself, a significant amount of electromagnetic radiation may be generated that can affect people as well as other equipment and systems.



WARNING

The device is designed for operation in industrial as well as home environment. For the intended operation, electromagnetic fields are generated by the connection of coupling devices (antennas, clamps, CDN etc.) or by the injection on lines. The operator, persons in the vicinity and the environment must be protected by suitable measures, e.g. Faraday cage.

1.15. Warranty Terms

AMETEK CTS provides this written warranty covering the product stated above, and if the buyer discovers and notifies AMETEK CTS in writing of any defect in material or workmanship within the applicable warranty period stated above, then AMETEK CTS may, at its option: repair or replace the product; or issue a credit note for the defective product; or provide the buyer with replacement parts for the product.

The buyer will, at its expense, return the defective product or parts thereof to AMETEK CTS in accordance with the return procedure specified below. AMETEK CTS will, at its expense, deliver the repaired or replaced product or parts to the buyer. Any warranty of AMETEK CTS will not apply if the buyer is in default under the purchase order agreement or where the product or any part thereof:

- is damaged by misuse, accident, negligence or failure to maintain the same as specified or required by AMETEK CTS;
- is damaged by modifications, alterations or attachments thereto which are not authorized by AMETEK CTS;
- is installed or operated contrary to the instructions of AMETEK CTS;
- is opened, modified or disassembled in any way without AMETEK CTS's consent; or
- is used in combination with items, articles or materials not authorized by AMETEK CTS.

The buyer may not assert any claim that the products are not in conformity with any warranty until the buyer has made all payments to AMETEK CTS provided for in the purchase order agreement.

1.16. Prohibition of unauthorized conversions and modifications

The user is not entitled to the device to perform its own modifications and adaptations. Modifying parts on the generator by unauthorized persons will void the warranty of the device and the correct functioning cannot be guaranteed.

1.17. Specific accessories required for safety reason

Only use accessories approved by AMETEK CTS for these generators and intended as accessories for these devices. Measuring instruments for the measurement of instrument parameters shall be designed for the maximum voltage and current from the generator. Otherwise safety cannot be guaranteed.

1.18. Procedure in case of hazard

If a hazard could exist due to an unintended condition of the device, the following procedure is recommended: Disconnect the device- and EUT power supplies from the power supply and ensure that the device is always earthed via the supply lines or a different ground connection. Wait at least 15 minutes and ground all outputs via a 10 k Ω , 15 W resistor. Call an AMETEK service center.

1.19. Cautions on handling the power meters

Generator mode, power meter mode

The power meter inputs are very sensitive. Please avoid any direct connection as shown below with careless adjustment of the generator output level. Be careful with low loss attenuators.

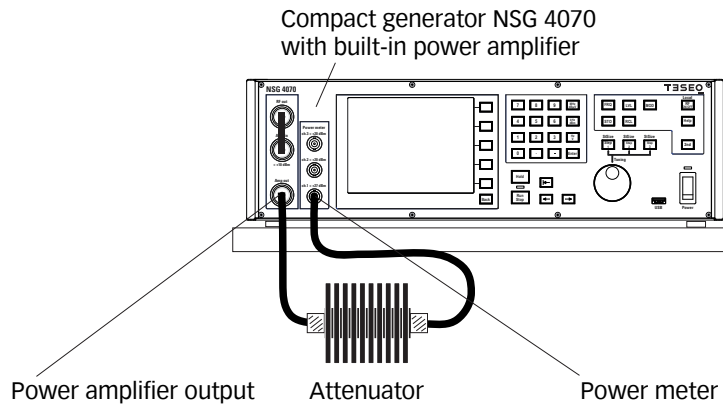

Mode	Generator mode, power meter mode	Generator mode, power meter mode
Level	-30 dBm	-10 dBm
Amplifier (e.g. 50 dB)	On	On
Amp output (forward power)	20 dBm	40 dBm
Attenuator	6 dB	6 dB
Power meter ch. 1 limit	27 dBm	27 dBm
Measured on ch. 1	$-30+50-6= 14$ dBm	$-10+50-6= 34$ dBm



Caution: Any input level above the limits of the power meter may **damage or destroy** the power meter. Such damage will not be handled by warranty.

Immunity mode

Please avoid any direct connection between power amplifier output and power meter input. Please remove the connection to power meter 1 after the system calibration is finished. The amplitude modulation, as described for IEC/EN 61000-4-39, increases the forward power with 5.1 dB which could damage the connected power meter 1. Certainly a connection is required for e.g. measuring the current with a current probe. Please always respect the power limits of the connected power meters, current probes, attenuators and other hardware.

The operation mode "CALIBRATION OF THE MONITOR PROBE" is intended for measuring the insertion loss of attenuators, cables and probes. The direct connection is allowed between power amplifier output and power meter channel 1. It allows a safe operation. The required power is adjusted to the related attenuation and measuring range of the power meters. The maximum output of the power amplifier will be adjusted in case of an interrupted connection to the power meter channel 1. All the connected hardware needs to be suitable for this power. Less qualified hardware may get damaged (e.g. attenuators connected on the calibration jig).

2. UNPACKING, STORAGE AND TRANSPORT

2.1. General

Save all packing materials! They will be needed in order to safely package the equipment for calibration service or repair.

Packaging materials

- Carton: Cardboard
- Padding: CFC-free polystyrene foam
- Plastic bags: Polyethylene





▶ Avoid the risk of condensation!

If a large temperature difference has occurred, allow time for the temperature to stabilize. This may take several hours.

2.2. Storage and transport

- ▶ Do not stack, either packaged or unpacked.
- ▶ Do not stand on end; arrows on the packaging must always point upwards.
- ▶ Protect from dampness, heat, cold and rain.
- ▶ Do not throw.
- ▶ Do not sit or stand on the instrument and packaging.

2.3. Unpacking

- Is the packaging damaged? If YES  transportation company
- Are all the packages present and correct? If NO  transportation company
- Open the packaging, remove the accessories.
- Grip the instrument at the sides and lift it from the packaging.
- Are the instrument or accessories damaged? If YES  transportation company
- Are the contents of the package complete? If NO  Teseq sales office
- Keep the instruction manual with the instrument.
- Keep the packaging.

2.4. Scope of delivery

- NSG 4070 mainframe
- Operating manual
- Spare fuses (2)
- RS232 cable (Nullmodem)
- Mains cable GB
- Mains cable CH
- Mains cable USA/JP
- Mains cable EU
- LAN cable, crossover, 3 m
- Keyboard (English)
- USO 4013 (USB to serial/optical converter with 20 m optical cable)

3. DESCRIPTION OF THE INSTRUMENT

3.1. General

The NSG 4070C1/C2-LFCP is a universal device for standard-compliant and development-accompanying EMC immunity tests in the application area of magnetic field testing in the close proximity according to IEC/EN 61000-4-39 and IEC/EN 60601-1-2. The NSG 4070C1/C2-LFCP integrates signal generator, directional coupler, power amplifier, power meter and EUT monitoring interfaces. The NSG 4070 can be operated quickly, conveniently and easily via the front panel as a free-standing device. Test and measurement data can be conveniently transferred for documentation purposes via a USB stick.

The wide frequency range of the signal generator and the power meter offer the possibility to connect external amplifiers and directional couplers. In combination with a remote control software, further applications can be covered, such as testing of conducted disturbances induced by high frequency fields according to IEC/EN 61000-4-6, automotive BCI tests e.g. according to ISO 11452-4 as well as high frequency electromagnetic fields according to IEC/EN 61000-4-3 or IEC/EN 61000-4-20. The NSG 4070C1/C2-LFCP can be remote controlled via LAN, electrical or optical RS232 as well as USB.

For EUT monitoring, the NSG 4070C1/C2-LFCP offers a variety of interfaces for flexibility in laboratory use.

In order to start with predefined parameter settings is recommended the optional test software icd.control. The software offers a large standard database and predefined drives for using external measuring devices. More complex systems including radiated tests can be controlled by using the software solution CIS (Compliance Immunity Software).

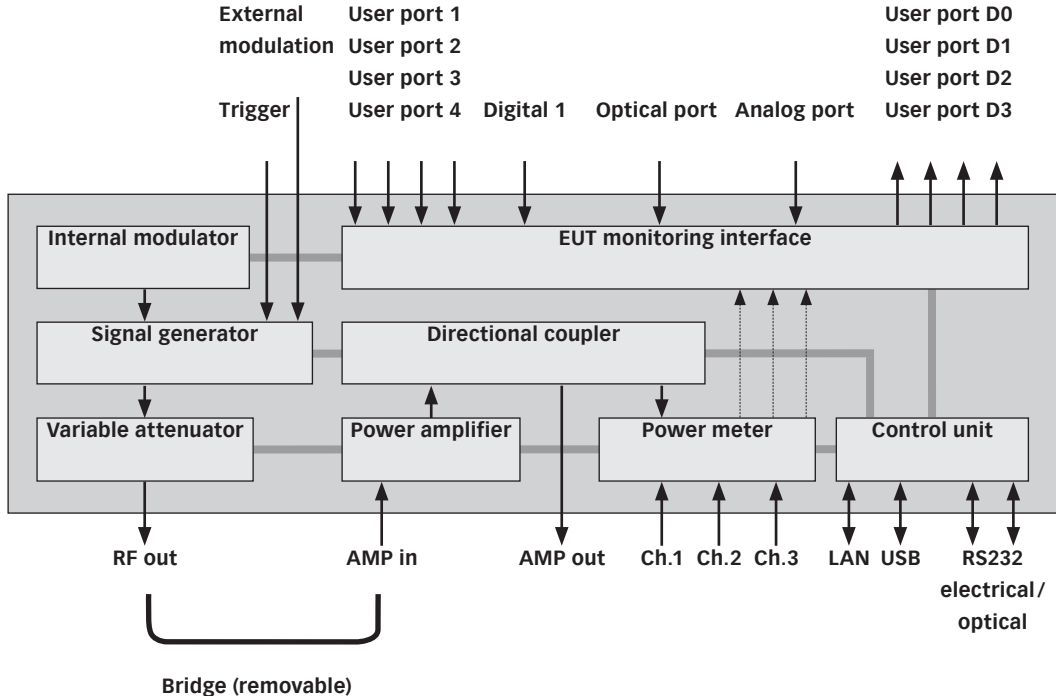

Figure 1: Block diagram of NSG 4070C1/C2-LFCP

3.2. Operating elements

3.2.1. Front panel

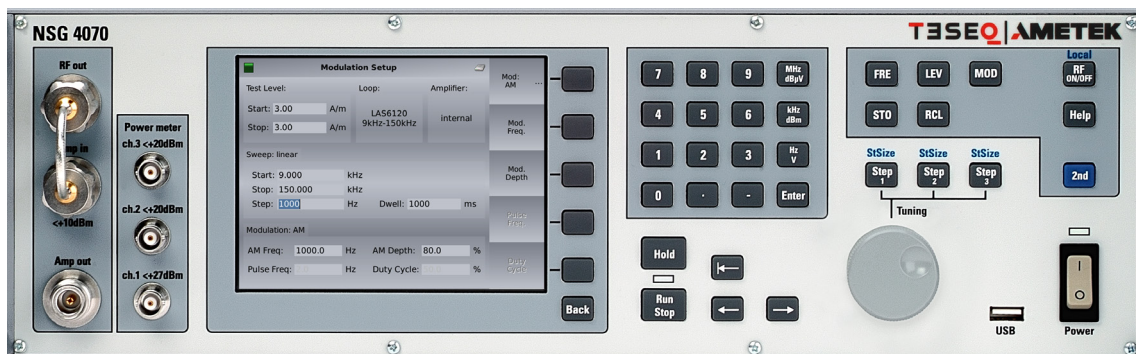
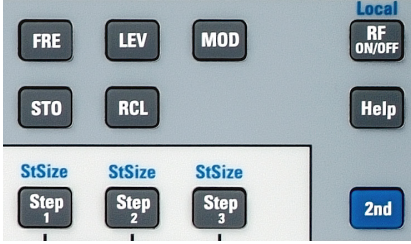
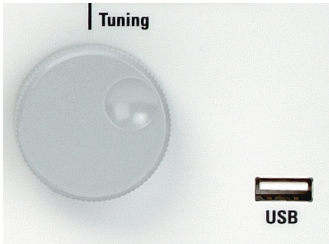
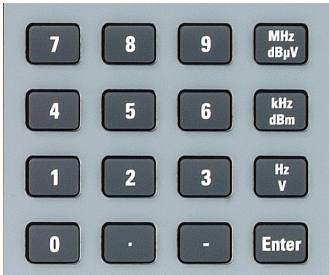

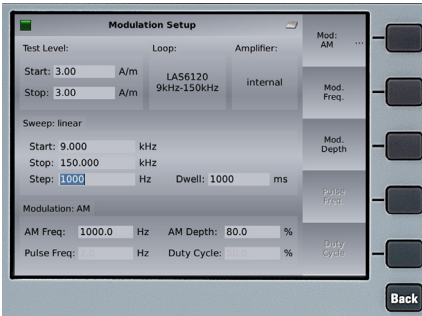



Figure 2: Front view of NSG 4070

<p>1</p>	<p>Power</p>	<p>Power</p>	<p>Power on key Hard key, switching takes effect with a short delay</p> <p>The LED next to the switch will turn from yellow to green when the unit is switched on.</p>
<p>2</p>		<p>FRQ</p> <p>LVL</p> <p>MOD</p> <p>STO</p> <p>RCL</p> <p>Step 1, Step 2, Step 3</p>	<p>FRQ Opens a softkey menu to change the frequency</p> <p>LVL Opens a softkey menu to change the test level</p> <p>MOD Opens a softkey menu to change the modulation parameters</p> <p>STO Opens a softkey menu to store test data or configurations</p> <p>RCL Opens a softkey menu to load test data or configurations</p> <p>Step 1, Step2, Step 3 Keys to select one of the three step sizes</p>

<p>3</p>		<p>RF ON/OFF</p> <p>Help</p> <p>2nd</p>	<p>RF ON/OFF Switches the internal signal generator on/off</p> <p>Help Key to call up the help text for all operating conditions. Depending on the current settings, explanations to the help function, explanations to hard and softkeys, and for adjustment facilities within menu will be displayed.</p> <p>2nd Additional function: marked in blue color 2nd + Local Keys to switch from remote control to manual operation 2nd + StSize Keys to change the step size, affects e.g. the using of the rotary knob</p>
<p>4</p>		<p>Tuning</p> <p>USB</p>	<p>Tuning The rotary knob has magnetic lock-in positions for parameter tuning and selection purposes.</p> <p>USB Interface for data exchange with USB stick</p>
<p>5</p>		<p>0...9</p> <p>-</p> <p>.</p> <p>MHz/dBµV kHz/dBm Hz/V Enter</p>	<p>Numeric keyboard numerical entry keys</p> <p>Minus sign</p> <p>Decimal point</p> <p>Input confirmation keys for the desired unit</p>

<p>6</p>		<p>Hold</p> <p>Run/Stop</p> <p>←</p> <p>←</p> <p>→</p>	<p>Hold Interrupts a sweep. The blinking yellow LED indicates the Hold state. There is a RF signal at the output.</p> <p>Run Starts the sweep specified in the setup. The blinking red LED indicates the RUN mode.</p> <p>Stop Stops a sweep that is currently running. The LED turns to green.</p> <p>Delete the character left of the cursor</p> <p>Moves the cursor left</p> <p>Moves the cursor right</p>
<p>7</p>		<p>Display</p> <p>Softkeys</p> <p>Back</p>	<p>Display Displays menus, softkeys and results.</p> <p>5 Softkeys, whose individual functions are dependent on the menu context.</p> <p>Back Key to return from any operating condition (menu, cancelling of entries, error messages) to the preceding higher-level menu</p>
<p>8</p>		<p>Power meter channel 1 to 3</p>	<p>Power meter inputs Impedance Z= 50 Ω BNC-socket Caution! Maximum input level +20 dBm for channel 2 and 3. Maximum input level +27 dBm for channel 1. If necessary use voltage limiters or attenuators.</p>



9		<p>RF out</p> <p>Amp in</p> <p>Amp out</p>	<p>RF out Synthesizer output to drive an external amplifier or use the NSG 4070 generator function.</p> <p>Amp in Power amplifier input (the power amplifier is optional) Caution! Maximum input level 0 dBm.</p> <p>Amp out Power amplifier output (the power amplifier is optional)</p>
---	---	---	--

3.2.2. Back panel

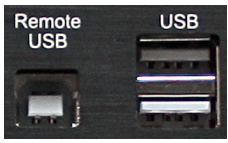
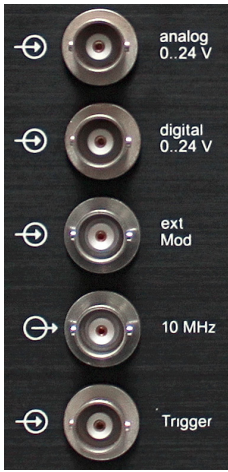

Figure 3: Back view of NSG 4070

10		Power supply	Power supply connector for wide range supply: 110/230 Volts, 50/60 Hz autoranging																										
11		Fuse	Fuse F1 See technical specifications for selection guide of fuse F1 in chapter 9.7.																										
12		User port	User port D-Sub 15 pole <table border="1" data-bbox="916 1373 1189 1787"> <thead> <tr> <th>Port</th> <th>Pin</th> </tr> </thead> <tbody> <tr><td>Digital in 0</td><td>1</td></tr> <tr><td>Digital in 1</td><td>2</td></tr> <tr><td>Digital in 2</td><td>3</td></tr> <tr><td>Digital in 3</td><td>4</td></tr> <tr><td>Digital out 0</td><td>6</td></tr> <tr><td>Digital out 1</td><td>7</td></tr> <tr><td>Digital out 2</td><td>8</td></tr> <tr><td>Digital out 3</td><td>9</td></tr> <tr><td>+12 V</td><td>15</td></tr> <tr><td>-12 V</td><td>14</td></tr> <tr><td>+5 V</td><td>13</td></tr> <tr><td>GND</td><td>5 and 10</td></tr> </tbody> </table> RS232 RS232 - interface for remote control of the NSG 4070 using a null modem connection	Port	Pin	Digital in 0	1	Digital in 1	2	Digital in 2	3	Digital in 3	4	Digital out 0	6	Digital out 1	7	Digital out 2	8	Digital out 3	9	+12 V	15	-12 V	14	+5 V	13	GND	5 and 10
Port	Pin																												
Digital in 0	1																												
Digital in 1	2																												
Digital in 2	3																												
Digital in 3	4																												
Digital out 0	6																												
Digital out 1	7																												
Digital out 2	8																												
Digital out 3	9																												
+12 V	15																												
-12 V	14																												
+5 V	13																												
GND	5 and 10																												

<p>13</p>		<p>Monitor optical</p>	<p>Input for optical EUT Monitoring, Fiber optic cable plug, HP versatile link HFBR0501 series 40 kBd</p>
<p>14</p>		<p>Remote USB</p>	<p>USB device connector</p>
<p>15</p>		<p>Analog input</p> <p>Digital input</p> <p>Ext. Mod.</p> <p>10 MHz</p> <p>Trigger</p>	<p>Monitoring input analog, BNC socket, 0-24 V Ri=15 kΩ, 6 mV resolution</p> <p>Monitoring digital input, BNC socket, 0-24 V via optical coupler Ri=1.5 kΩ, switching threshold approx. 2 to 3 V</p> <p>External modulation input, BNC socket, Impedance >10 kΩ, Level: 1 Vpp/ 100% AM, 1 Hz – 50 kHz</p> <p>10 MHz reference output, BNC socket, approx. 1 Vpp/50 Ω Please note: The connected signal will be mixed with the selected internal modulation. Disconnect this port for using the internal modulation only.</p> <p>Trigger input BNC socket, TTL for external triggering</p>
<p>16</p>		<p>Fans</p>	<p>3 Fans for cooling the internal parts of the unit</p>

4. EXPLANATION OF THE MENU-CONTROLLED OPERATION

4.1. General

4.1.1. Menu control with softkeys and hardkeys

The function of each softkey is shown on the display, and can be operated using the 5 keys at the right of the screen.

A selection will be terminated either by pressing one of the enter / unit keys or another softkey or automatically.

Menus can be quit using "BACK". Pressing "BACK" several times will always lead back to the main menu ("Main").

4.1.2. Help function ("HELP")

The "HELP" key enables the display of a help text in most operating situations.

4.1.3. Numerical input using the numerical keyboard

Inputs of numerical values must start with a digit or the minus sign and will be terminated by one of the enter / unit keys for the desired unit. The input value appears in the selected field. Typos can be corrected using backspace  to delete the digit to the left of the cursor. Mistakes will usually be corrected to the nearest valid value; too many input digits will be rounded.

4.1.4. Secondary functions

The secondary function of some keys is marked above the keys in blue. For calling a secondary function press the "SECOND"-key (blue key) and then the desired function key.

4.1.5. Level setting, frequency setting, modulation setting and tuning

4.1.5.1. Level setting

Level setting is done using the "LVL" hard key. The desired level can be set either by typing in a numerical value or by using the rotary knob which sets the level in fixed steps.

4.1.5.2. Frequency setting

Frequency setting is done using the "FRQ" hard key. The desired frequency can be set either by typing in a numerical value or by using the rotary knob which sets the frequency in fixed steps.

4.1.5.3. Modulation setting

Modulation frequency setting is done using the "MOD" hard key. The desired modulation parameters, i.e. AM, pulse or external modulation as well as the modulation frequency and depth / duty cycle can be set.

4.1.5.4. Tuning using the rotary knob

The rotary knob is used for frequency or level tuning.

"STEP1", "STEP2" and "STEP3" are user defined step sizes. The step size can be defined by pressing the "SECOND" key and "STEP1", "STEP2" or "STEP3" and typing in a numerical entry. The desired step size can be selected by pressing the corresponding key (without "SECOND" key).

4.1.6. Saving and loading of configurations and results

4.1.6.1. General

There are two options for storing or recalling results:

- a) Saving/recalling data to/from the internal flash disk.
- b) Saving/recalling data to/from the USB stick.

4.1.6.2. Store

The hard key "STO" opens a menu to save configurations, calibration and measurement results. Menu items include:

"CONFIG": To save the settings of the current measurement as a configuration file to the internal flash or USB stick.

"SYSTEM CAL.": To save the calibration results of the test setup to the internal flash or USB stick.

"PROBE CAL.": To save the calibration results of the monitoring probe to the internal flash or USB stick.

"RESULTS": To save the measurement results of the current measurement together with the corresponding configuration as a result file to the internal flash or USB stick.

Return from the sub menu with "BACK".

4.1.6.3. Recall

The hard key "RCL" opens a menu to load configurations, calibration and measurement results. Menu items include:

"CONFIG": To recall the settings from the internal flash or USB stick.

"SYSTEM CAL.": To recall the calibration results of the test setup from the internal flash or USB stick.

"PROBE CAL.": To recall the calibration results of the monitoring probe from the internal flash or USB stick

"RESULTS": To recall the measurement results together with the corresponding configuration from the internal flash or USB stick.

4.2. Main menu



The "MAIN" menu of the NSG 4070 is always displayed after switching on the device. The "MAIN" menu provides the following choices: The "SETUP" menu provides access to general configurations. The "POWER METER" mode and "GENERATOR MODE" allow using the unit as RF generator. The "IMMUNITY MODE" gives the functionality for doing EMC testing. The "INFO" menu shows information about the hardware/software configuration and device serial number.

4.3. Setup



"DEVICE SETUP" provides access to the device configuration.

4.3.1. Setup → General



"GENERAL SETUP" provides access to the language, display colors and date & time configurations.

4.3.1.1. Setup → General → Language setup



Language can be selected in this setup. The unit needs to be restarted after changing the language.

4.3.1.2. Setup → General → Color theme setup



“COLOR SETUP” allows the user to change the color of the display.

4.3.1.3. Setup → General → System time & date setup

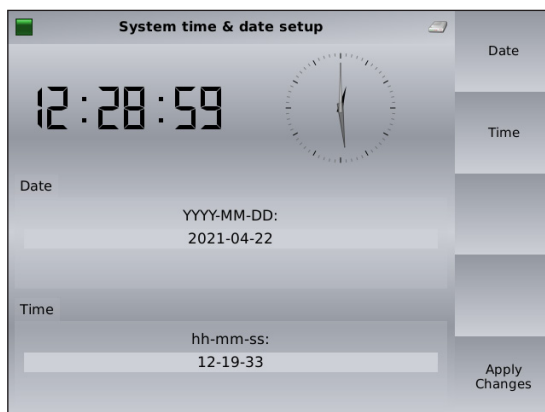

Time and date can be set in this submenu.

4.3.2. Setup → Remote control setup

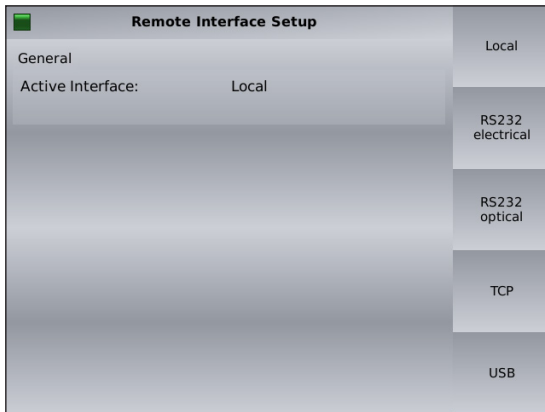

“REMOTE CONTROL SETUP” provides the remote control settings of the device. This main screen gives an overview about the current parameters. Submenus provide access to the parameters.

4.3.2.1. Setup → Remote control setup → Remote interface setup

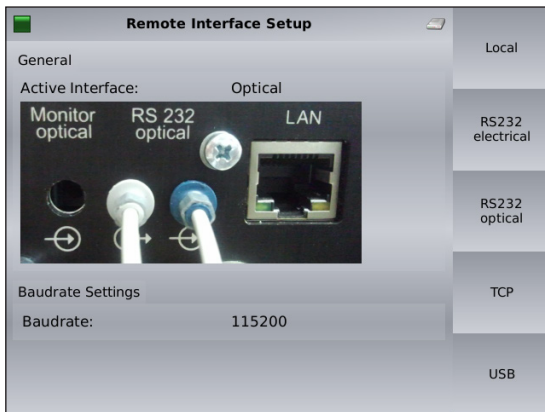

“REMOTE INTERFACE SETUP” allows the user to change the remote port. The selection “LOCAL” prohibits remote control. The selection “RS232 OPTICAL” provides a picture for helping the correct connection.

■ RS232 electrical is selected as remote interface.

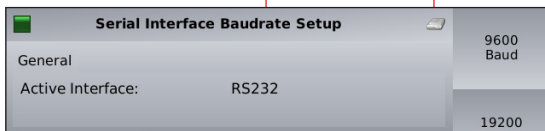

■ TCP is selected as remote interface.

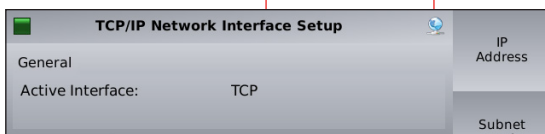

■ USB is selected as remote interface.



4.3.2.2. Setup → Remote control setup → TCP/IP Network interface setup

Settings for the TCP/IP network can be changed in this setup.

4.3.2.3. Setup → Remote control setup → Serial interface setup

Settings for the serial interface can be changed in this setup. Submenus provide access to the parameters for the baudrate and to switch the handshake on/off.

Baudrate can be chosen in the baudrate setup. The default value is 115200 baud.

4.3.3. Setup → Power limitations

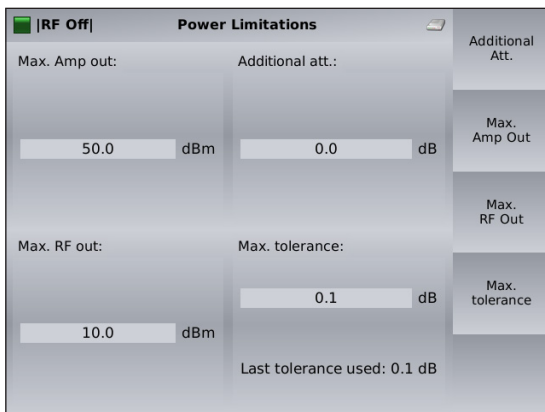

The menu "POWER LIMITATIONS" allows the user to set system limits.

The softkey "MAX. AMP OUT." allows the user to set a limit for the maximum forward power.

The softkey "ADDITIONAL ATTENUATOR" allows the user to use an additional attenuator to protect power meter 1 against levels above the maximum input power of this channel. Enter 10 for an attenuator of 10 dB.

The softkey "MAX. RF OUT." allows the user to set a limit for the maximum generator power (RF output of NSG 4070).

The softkey "MAX. TOLERANCE" allows the user to increase the control tolerance of the system as maybe needed for EUTs with nonlinear feedback.

4.3.4. Setup → Directional coupler

Freq. in Hz	Forw. att. in dB	Rev. att. in dB
9000	39.90	39.93
10000	39.92	39.94
20000	40.02	40.04
30000	40.03	40.05
40000	40.04	40.05
50000	40.04	40.06
60000	40.05	40.05
70000	40.04	40.05
80000	40.05	40.05
90000	40.03	40.05
100000	40.04	40.05
200000	40.03	40.04
300000	40.02	40.04
400000	40.02	40.04
500000	40.02	40.03
600000	40.02	40.03
700000	40.01	40.03
800000	40.02	40.02

The softkey "LOAD FILE" offers the import function for the coupling attenuation calibration factors of the external directional coupler.

The use of an external amplifier also requires an external directional coupler. The coupling attenuation must be imported from the USB stick. The file has to be in ASCII format and must contain 3 columns separated by a comma. The first column is the frequency in Hz, the second represents the forward coupling attenuation and the last column is the reverse coupling attenuation. An example is shown below:

```
10000,39.9,39.7
100000,39.9,39.7
30000000,39.9,39.8
100000000,40.3,40.2
1000000000,39.9,40.2
```

4.3.5. Setup → Service



The "SERVICE MENU" is password protected and only accessible by authorized Teseq service personnel.

4.4. Power meter menu



A warning note appears to remind the user for switching off the modulation. Otherwise strange power meter values may occur.

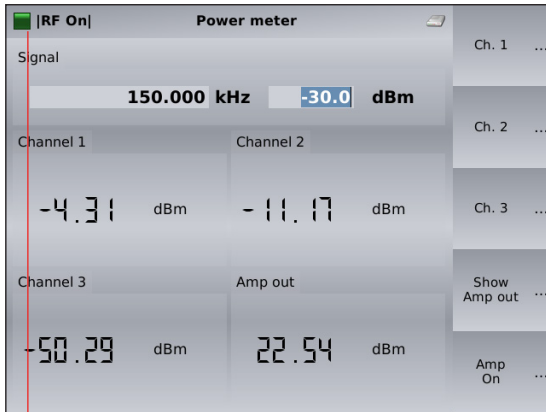

The "POWER METER MENU" provides power meter readings (Channel 1 to 3) and also allows the display of the forward power (Amp out).

The internal power amplifier can be switched on/off with the softkey "AMP ON".

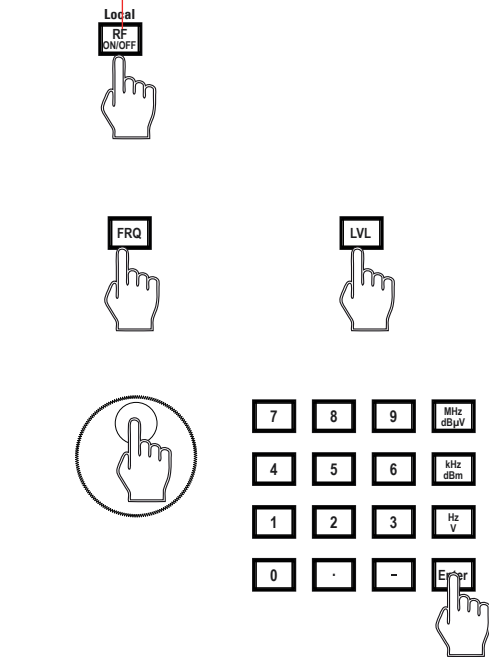

The generator can be switched on/off with the hardkey "RF ON/OFF".

The generator frequency and level can also be set of the generator. The hardkey "FRQ" allows the user to change the test frequency with the rotary knob (see chapter 4.1.5.4 for changing the step size) or the numeric keyboard.

The hardkey "LVL" allows the user to change the test level with the rotary knob or the numeric keyboard.

The numeric input has to be terminated with the hardkey "ENTER" or with the specified unit key "MHz/dbμV", "kHz/dBm" or "Hz/V". The accepted value is displayed with green background color for a short while.

4.5. Immunity menu

4.5.1. Immunity menu: Recall configurations



The NSG 4070C1/C2-LFCP offers some default configuration based on the requirements of the standards IEC/EN 61000-4-39 and IEC/EN 60601-1-2.

After pressing the "RCL" key, the "CONFIG" softkey, and selecting the relevant folder, the configuration is selected from the internal flash or the USB stick by turning the rotary knob and loaded with the "LOAD" softkey.

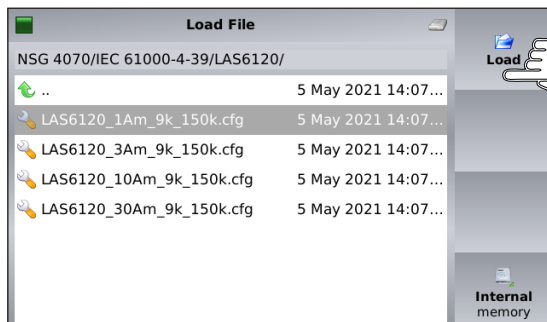
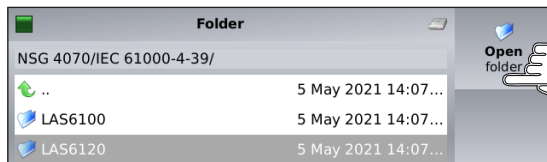

Attention: A configuration does not contain any calibration data. After loading a the required calibration files must be loaded or generated.

4.5.2. Immunity menu → Main

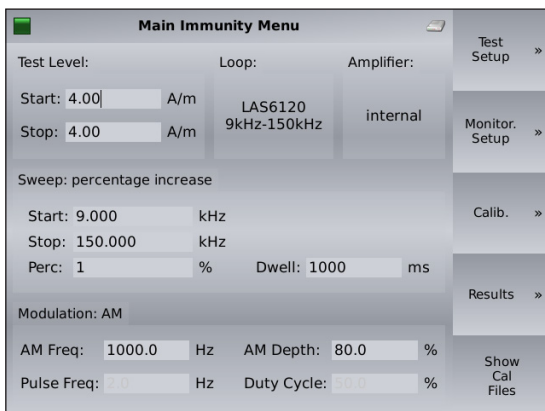

The "MAIN IMMUNITY MENU" gives an overview of the test parameters. The example shows a test according IEC/EN 61000-4-39 for the range 9 kHz to 150 kHz with LAS 6120. The parameter can be changed in the menu "TEST SETUP".

4.5.3. Immunity menu → Test Setup

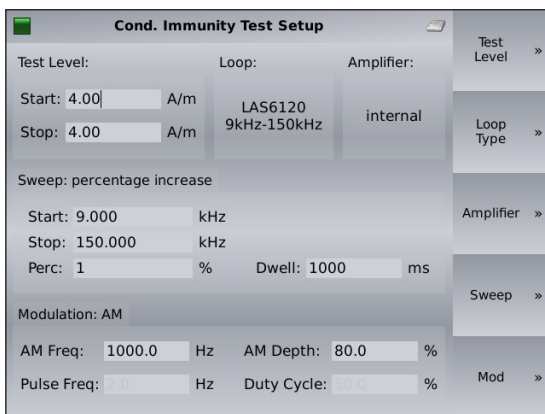

The test parameters can be set with the softkey "TEST SETUP".

4.5.3.1. Immunity menu → Test setup → Test level

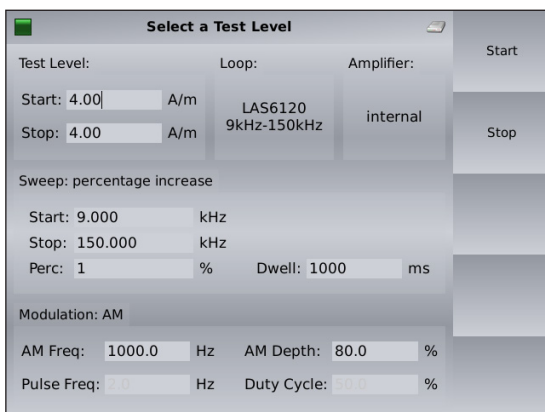

The start and stop levels can be set in the "SELECT A TEST LEVEL" setup.

Level profiles can be built with the function "SECTIONS" of the menu "SWEEP MODE". The parameter of the activated sections will be used in case of using this function. The display is changed and shows the sections in a table. The start and stop levels of the "SELECT A TEST LEVEL" setup are deactivated.

4.5.3.2. Immunity menu —> Test setup —> Loop type

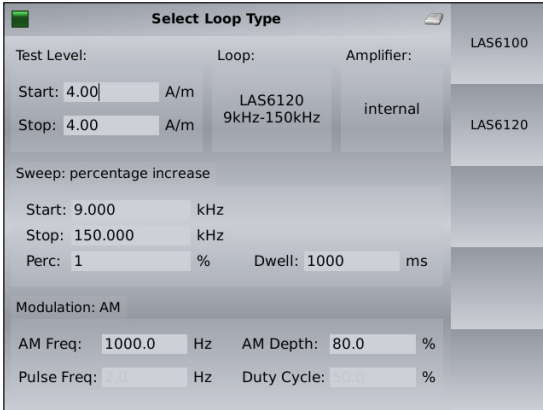

“SELECT A LOOP TYPE” allows the user to choose the loop antenna set.

4.5.3.3. Immunity menu —> Test setup —> Amplifier

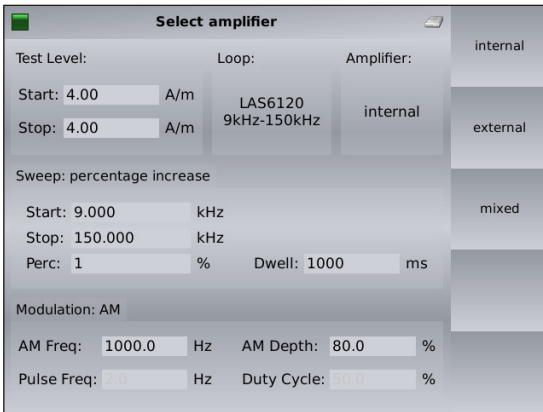

“SELECT AMPLIFIER” allows the user to select an internal or external power amplifier. “MIXED” allows to use the internal power amplifier with an external directional coupler.

4.5.3.4. Immunity menu —> Test setup —> Sweep

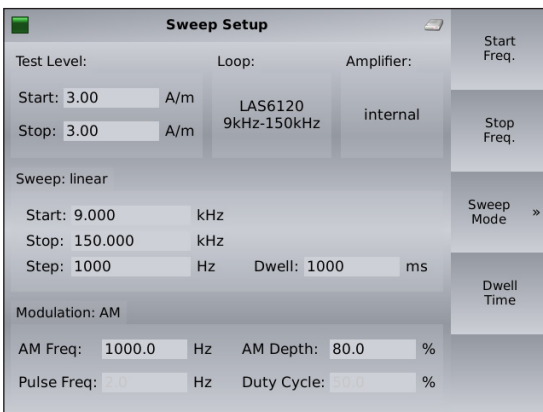

Start and stop frequency, sweep mode and dwell time can be set in the “SWEEP SETUP”. Level profiles can be built with the function “SECTIONS” of the menu “SWEEP MODE”. The parameter of the activated sections will be used in case of using this function. The display is changed and shows the sections in a table. The start and stop frequencies as well as the step and dwell time of the top menu “SWEEP SETUP” are deactivated.

4.5.3.4.1. Immunity menu → Test setup → Sweep → Sweep mode

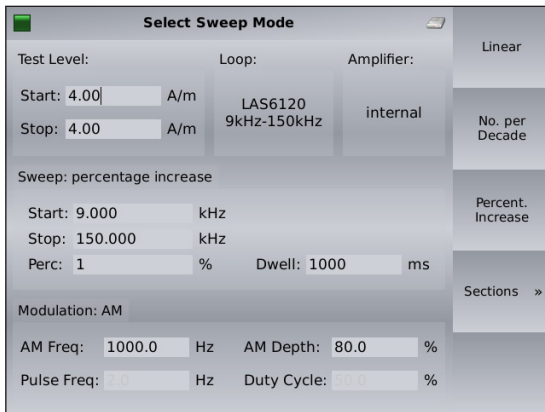

“SWEEP MODE” can be set to linear, numbers per decade or percent increase of the frequency.

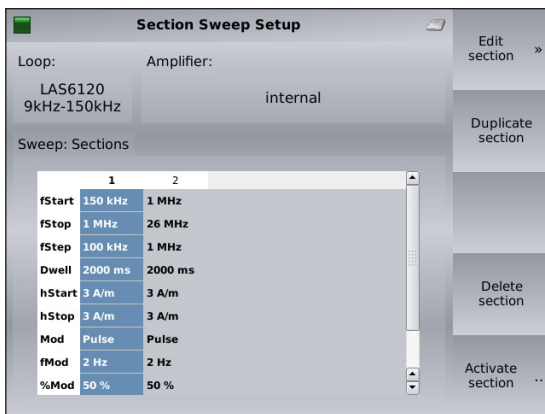

The softkey “SECTIONS” and the following sub menus allow to create test profiles. Using the turn key allows to select the section. “EDIT SECTION” opens the section for the parameter input or change. “DUPLICATE SECTION” creates another section with the same parameter settings. “DELETE SECTION” erases the selected section. The softkey “ACTIVATE” activates the section.

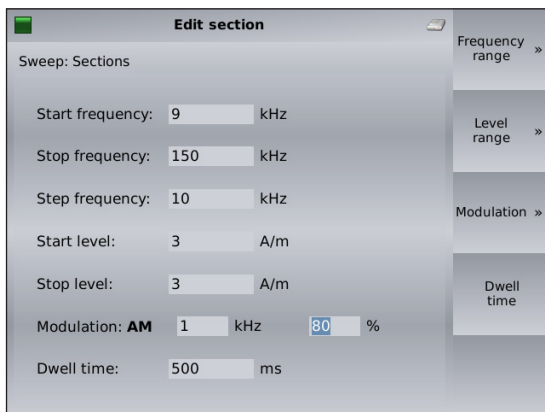

The softkey “FREQUENCY RANGE” opens a sub menu to set the start, stop and step frequencies. The softkey “LEVEL RANGE” opens a sub menu to set the start and stop level. The softkey “MODULATION” opens a sub menu to set the modulation parameter. The softkey “DWELL TIME” allows to set the dwell time.

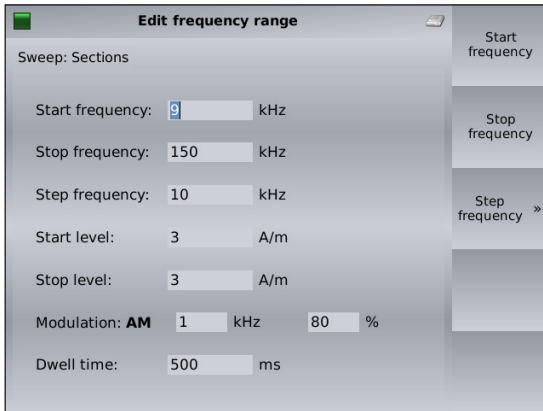

The menu "EDIT FREQUENCY RANGE" allows to set the start, stop and step frequencies. The softkey "STEP FREQUENCY" opens a sub menu to set the step frequencies.

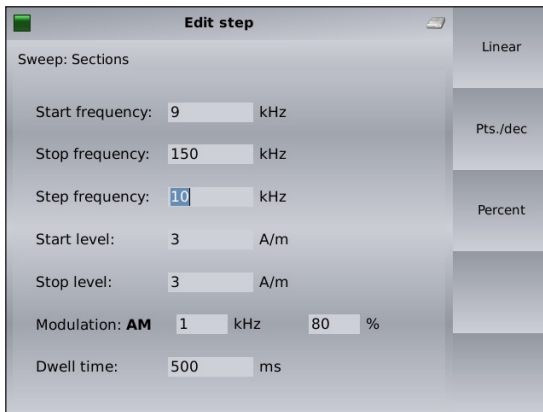

The menu "EDIT STEP" allows to define linear, numbers per decade or percent increase of the frequency.

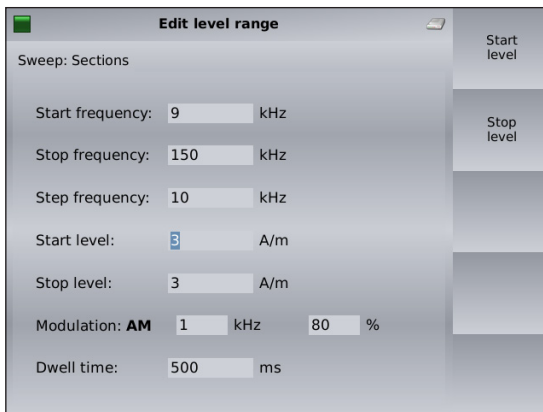

The menu "EDIT LEVEL RANGE" allows to set the start and stop levels.

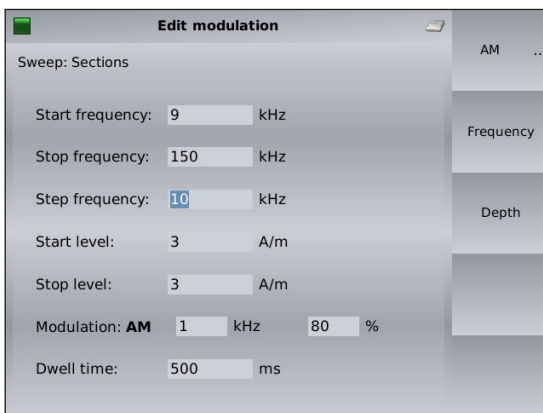

The menu "EDIT MODULATION" allows to set the modulation parameters. Modulation can be set to AM, AM PC, pulse modulation, external modulation or off. The modulation can be changed by pressing the upper softkey.

AM: Amplitude modulation

AM PC: Amplitude modulation with peak conservation as described in ISO 11452-1

PM: Pulse modulation

Ext.: External modulation

Off: Modulation off

4.5.3.5. Immunity menu → Test setup → Modulation

Modulation Setup

Test Level: Start: 3.00 A/m Stop: 3.00 A/m

Loop: LAS6120 9kHz-150kHz

Amplifier: internal

Sweep: linear Start: 9.000 kHz Stop: 150.000 kHz Step: 1000 Hz Dwell: 1000 ms

Modulation: AM

AM Freq: 1000.0 Hz AM Depth: 80.0 %

Pulse Freq: 0.0 Hz Duty Cycle: 50.0 %

Mod: AM ...

Mod. Freq.

Mod. Depth

Pulse Freq.

Duty Cycle

Modulation can be set to AM, AM PC, pulse modulation, external modulation or off. The modulation can be changed by pressing the upper softkey.

AM: Amplitude modulation

AM PC: Amplitude modulation with peak conservation as described in ISO 11452-1

PM: Pulse modulation

Ext.: External modulation

Off: Modulation off

Level profiles, can be built with the function "SECTIONS" of the menu "SWEEP MODE". The parameter of the activated sections will be used in case of using this function. The display is changed and shows the sections in a table. The modulation parameter of the menu "MODULATION SETUP" are deactivated.

4.5.4. Immunity menu → Monitoring setup

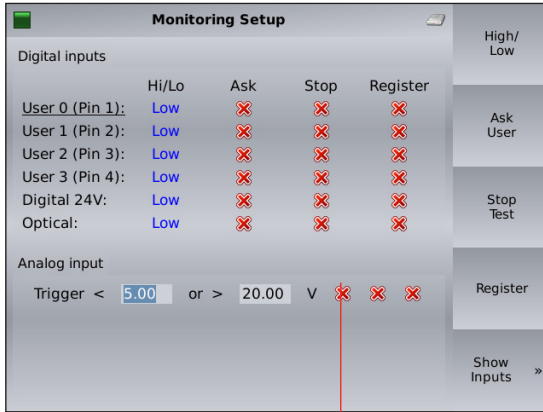

There are several EUT monitoring ports:

- User port input 0 to 3: (4 bit TTL in)
- Digital 1: up to 24 V
- Optical input
- Analog input: 0-24 V

Each monitoring port can be individually configured. The switching condition can be set to high or low active using the softkey "HIGH/LOW". For analog input a window can be defined which can be used as a threshold or tolerance window.

The action in case of a trigger event (EUT failure) can be set either to register the occurrence of the event (lowest priority), to stop the test, or user decision (highest priority) using the corresponding softkeys. "STOP TEST" automatically includes the registration of the event; "ASK USER" allows the user to stop or continue the test.

■ A green tick indicates that the monitoring port is enabled, a red cross a disabled port.

- ✓ selected
- × not in use

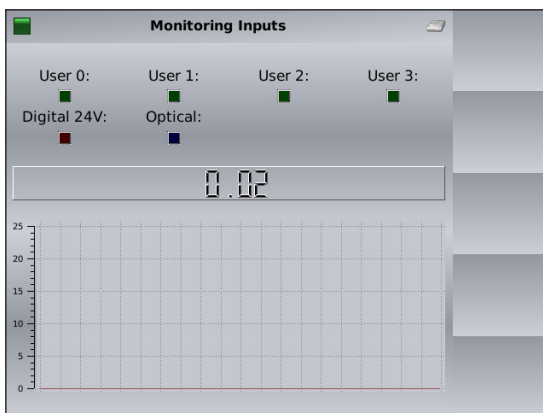

The function "SHOW INPUTS" shows each monitoring state. The color of each box indicates high or low. The analog port voltage is displayed below the boxes. The graph shows a 10 second history of input activity.

4.6. Calibration

A precondition for the execution of tests is a loaded system calibration file and for the range below 150 KHz a loaded calibration for the current probe. This chapter shows how to load, create and save the calibration files. Also for the execution of the calibrations preconditions and a sequence are to be considered.

1. Load the loop calibration data (receiving loop).
2. Range 9 kHz to 150 kHz only: Perform the probe calibration or load the probe calibration data (current probe).
3. Perform the system calibration.

4.6.1. Immunity menu: Recall the loop calibration data (receiving loop)



With the "RCL" key and the "Loop Cal." softkey, the calibration data of the receiving loop must be assigned to the configuration from the internal flash or the USB stick.



The file can be selected by turning the rotary knob. Use the file Loop_Corr_default.xml using the FSL 6040-51 (part of LAS 6120) for the frequency range 9 kHz to 150 kHz and the FSL 6040-1 (part of LAS 6100) for the frequency range 150 kHz to 26 MHz.



An example of the content of the file Loop_Corr_default.xml is shown below. In case the values for the receiving coil are different from the theory, the difference values would have to be brought into an xml file and loaded via a USB stick. The theoretical values used for the NSG 4070C1/C2-LFCP can be found in tables 5 to 9 for LAS 6120 and tables 10 to 15 for LAS 6100. More detailed values, more interpolation points, are in the LAS 6120 and LAS 6100 instruction manuals.

```

<loop_correction>
<comment> Default Correction for FSL6040_51, 9kHz - 150kHz and FSL6040_1, 150kHz - 50MHz </
comment>
<values>
<val> <freq> 9000 </freq> <corr> 0.0 </corr> </val>
<val> <freq> 10000 </freq> <corr> 0.0 </corr> </val>
<val> <freq> 12000 </freq> <corr> 0.0 </corr> </val>
<val> <freq> 15000 </freq> <corr> 0.0 </corr> </val>
<val> <freq> 25000 </freq> <corr> 0.0 </corr> </val>
<val> <freq> 40000 </freq> <corr> 0.0 </corr> </val>
<val> <freq> 50000 </freq> <corr> 0.0 </corr> </val>
<val> <freq> 100000 </freq> <corr> 0.0 </corr> </val>
<val> <freq> 150000 </freq> <corr> 0.0 </corr> </val>
<val> <freq> 160000 </freq> <corr> 0.0 </corr> </val>
<val> <freq> 500000 </freq> <corr> 0.0 </corr> </val>
<val> <freq> 1000000 </freq> <corr> 0.0 </corr> </val>
<val> <freq> 2000000 </freq> <corr> 0.0 </corr> </val>
<val> <freq> 5000000 </freq> <corr> 0.0 </corr> </val>
<val> <freq> 10000000 </freq> <corr> 0.0 </corr> </val>
<val> <freq> 20000000 </freq> <corr> 0.0 </corr> </val>
<val> <freq> 26000000 </freq> <corr> 0.0 </corr> </val>
<val> <freq> 50000000 </freq> <corr> 0.0 </corr> </val>
</values>
</loop_correction>

```

4.6.2. Immunity menu: Recall probe calibration data



For the range 9 kHz to 150 kHz, the IEC/EN 61000-4-39 standard requires the use of a current probe. It must be selected before the system calibration or before the execution of the test.



After pressing the "RCL" key, the "PROBE CAL." softkey, the calibration file is selected from the internal flash or the USB stick by turning the rotary knob and loaded with the "PROBE CAL." softkey.

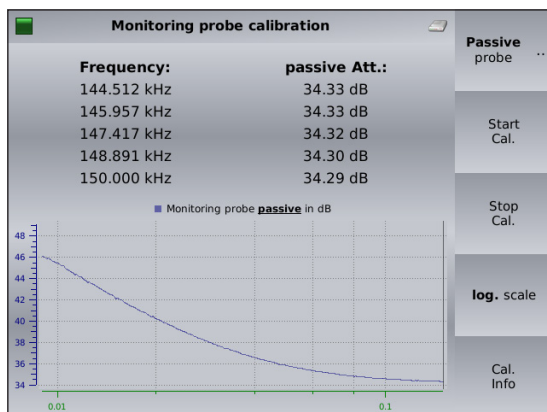
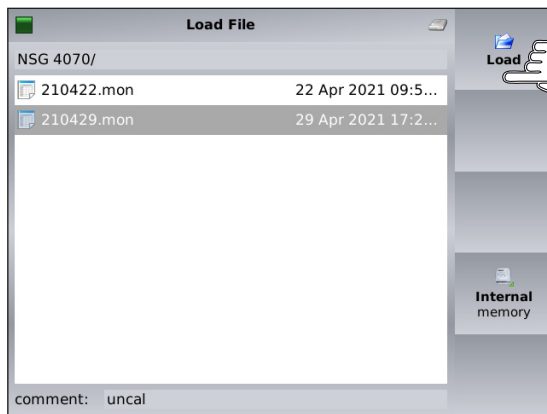

As an alternative to the Probe calibration, the correction values for the current clamp can be loaded if they have been determined by a calibration laboratory, for example. The data must be converted into the form shown below and saved / loaded as a text file with the ending .csp. A value of -34 dB corresponds to an insertion loss of 34 dB or 0 dBS. See also user manual LAS 6120 and CSP 9160. In the case of the CSP 9160A, the active coupling factor remains free. It is to be used for other applications with the switchable MD 4070.

#frequency in Hz, passive coupling factor in dB, active coupling factor in dB

```
9000, -46.50
10000, -45.59
20000, -40.47
30000, -38.05
40000, -36.75
50000, -35.99
60000, -35.52
70000, -35.23
80000, -34.99
90000, -34.88
100000, -34.76
110000, -34.66
120000, -34.61
130000, -34.56
140000, -34.52
150000, -34.47
```

4.6.3. Immunity menu → Calibration

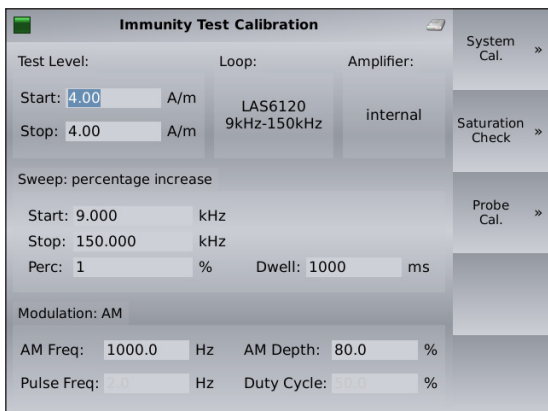

Two types of calibration can be performed:

- system calibration for the entire setup
- probe calibration for the monitoring probe.

The “SATURATION CHECK” function allows the user to test the necessary power reserve for the testing with amplitude modulation.

4.6.3.1. Immunity menu → Calibration → System calibration

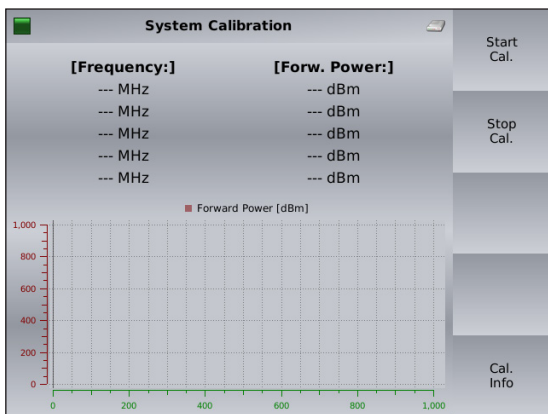

The softkey “START” starts the calibration and “STOP” terminates the calibration.

During calibration the current frequency and forward power are displayed in the table as well as in the graph. In the range 9 kHz to 150 kHz the current is also displayed.

The internal control algorithm provides a maximum deviation of ± 0.1 dB to the target calibration level.

The start frequency, stop frequency, test level, step mode, calibration data (receiving loop antenna and probe if used) internal or external amplifier have to be defined in the “TEST SETUP” menu before calibration. The calibration is independent of the selected dwell time and modulation parameters.

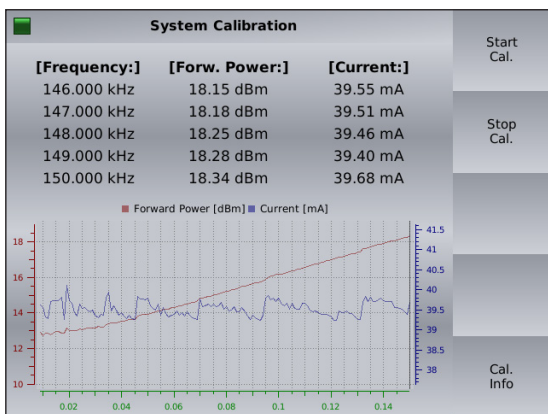

The calibration result can be observed by turning the rotary knob.

The red curve shows the forward power of the calibration which is related to the left axis. The blue curve shows the current (range 9 kHz to 150 kHz) of the calibration which is related to the right axis.



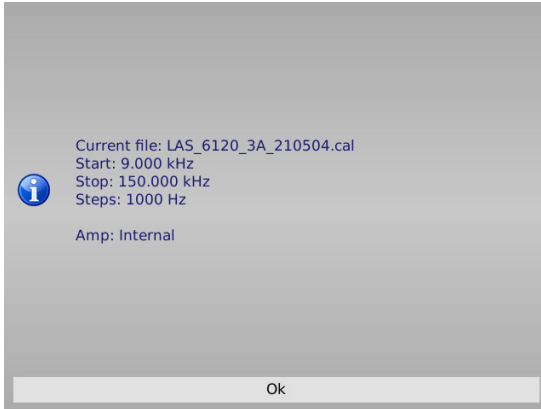

The softkey "CAL. INFO" provides the file name, start frequency, stop frequency, steps, start level, stop level and amplifier internal or external. An example is shown to the left.

4.6.3.2. Immunity menu → Calibration → Saturation check

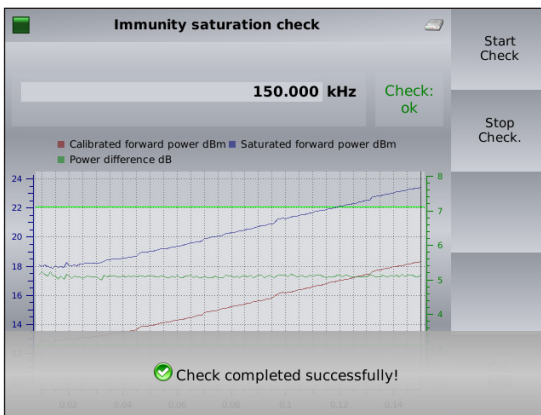

This function allows the user to check whether there is sufficient power available for the selected modulation required, even if the system calibration is always performed without modulation. Special high test levels could bring the power amplifier into saturated range if the modulation (e.g. AM with 80% needs 5.1 dB more power) is switched on during EUT testing. The check requires a loaded calibration file. The forward power of the calibration is increased with 5.1 dB during the check.

The result of the "SATURATION CHECK" is provided in a graph. The lower curve shows the calibrated forward power in red. The upper curve shows the increased forward power during the check. Both curves are related to the left axis. The green curve shows the check result (difference) and is related to the right axis. For having the power reserve the check result should be around 5.1 dB.

The softkey "START" starts the check and "STOP" terminates the check. The softkey "CAL. INFO" provides the file name, start frequency, stop frequency, steps, start level, stop level and internal or external amplifier.

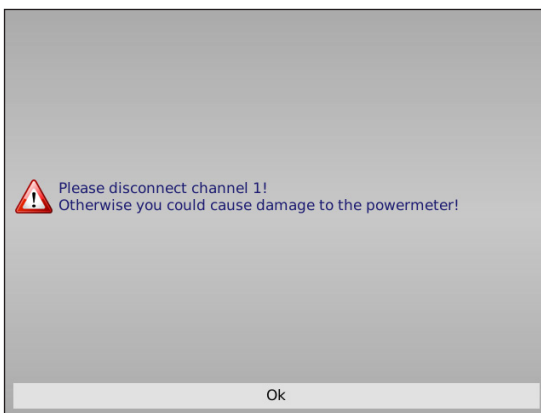

The forward power of the calibration is increased by 5.1 dB during the check. This could damage the power meter channel 1. It is strongly recommended to disconnect the power meter channel 1 for the "SATURATION CHECK". A message box, shown on the left side, reminds the user to follow this advice.

4.6.3.3. Immunity menu → Calibration → Probe calibration

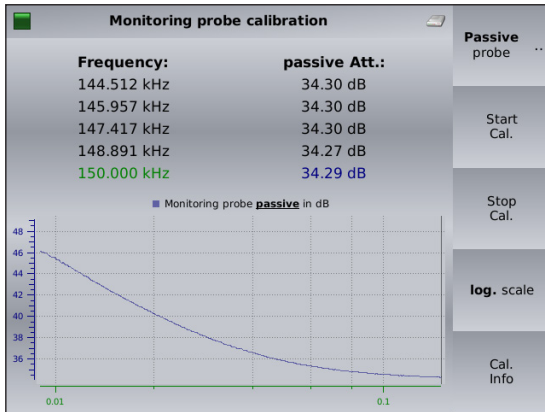

The "PROBE CALIBRATION" function allows the user to calibrate a current probe in a 50 Ω jig. During the calibration the current frequency and attenuation are displayed in the table as well as in the graph.

The start frequency, stop frequency, step mode, internal or external amplifier have to be defined in the "TEST SETUP" menu before calibration.

The calibration is independent of the selected test level, dwell time and modulation parameters.

The "PROBE CALIBRATION" function can also be used for checking the setup, cable or attenuator.

The softkey "START" starts the calibration and "STOP" terminates the calibration.

The softkey "MD 4070 PASSIVE" / "MD 4070 ACTIVE" allows the user to switch the probe to passive or active mode if connected (cable LE 242) with the user port of the NSG 4070.

The softkey "CAL. INFO" provides the file name, start frequency, stop frequency and steps. An example is shown on the left side.

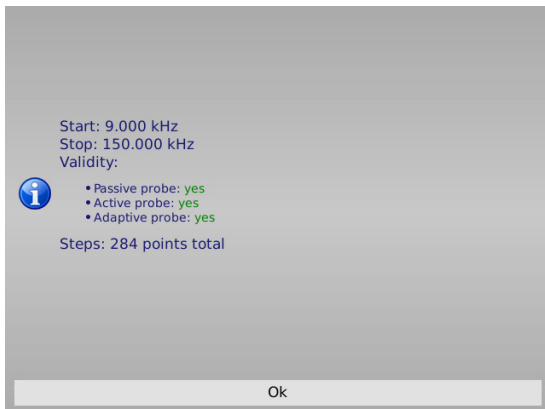

4.6.3.4. Immunity menu: Store and recall system calibration data



In general, the hard keys "STO" and "RCL" allow the user to store and to recall configurations, calibration data, probe calibration and results.



Store

Pressing the hard key "STO" followed by the soft key "SYSTEM CAL." allows the user to save the calibration results of the test setup to the internal flash or USB stick as file type ".cal".

Included in the calibration file are:

- Start and stop frequency
- Start and stop level
- Amplifier internal / external
- Forward power versus frequency
- "FILE COMMENT"

The file comment offers additional information to the calibration file and can be filled out before saving the file.

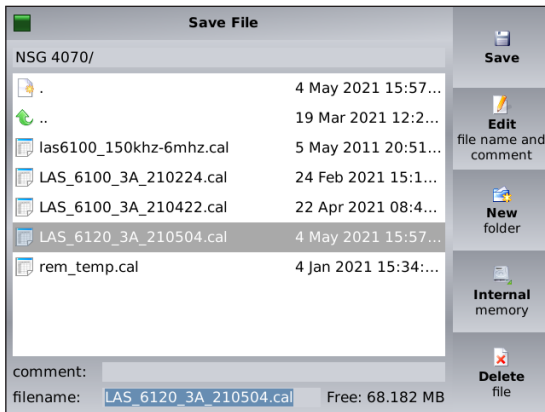

Recall

Pressing the hard key "RCL" followed by the soft key "SYSTEM CAL." allows the user to recall the calibration results of the test setup from the internal flash or USB stick.



The stored file can be selected by turning the rotary knob.

4.6.3.5. Immunity menu: Store probe calibration data



Pressing the hard key "STO" followed by the soft key "PROBE CAL." allows the user to save the probe calibration results to the internal flash or USB stick as file type ".mon".



The probe calibration file includes:

- Start and stop frequency
- Frequency step information
- Insertion loss versus frequency
- "FILE COMMENT"

The file comment provides additional information relating to the calibration file and can be filled out by the user before saving the file.

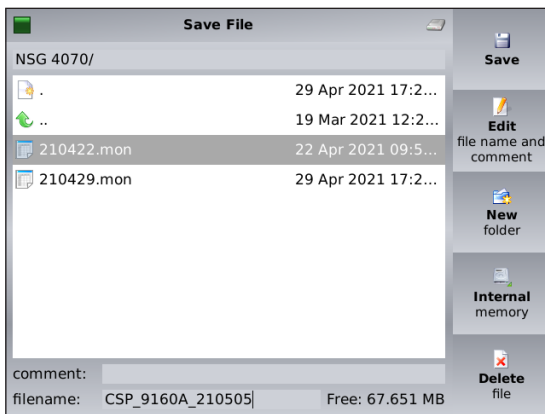

4.6.4. Immunity menu → Results

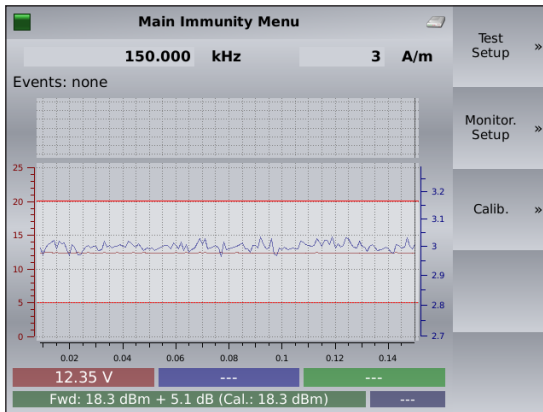

The softkey "RESULTS" shows the current test result which can be investigated by turning the rotary knob. The red curve shows the voltage on the analog EUT monitoring input, and is related to the left axis. Other EUT monitoring events are displayed above the graph with different colors.

The blue curve shows the test level of the test configuration. It is related to the right axis.

The green curve shows the used current for the BCI testing with monitoring probe. It is related to the right axis.

4.6.5. Immunity menu: Testing

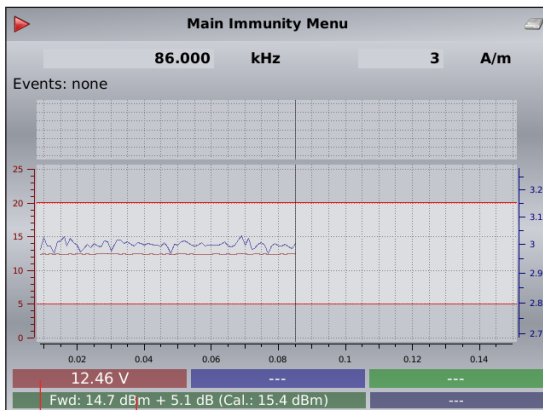

■ Used forward power (Fwd.) additionally the reserve needed for the AM (+5,1 dB)

■ Calibrated forward power (Cal.)

■ Voltage on the analog EUT monitoring input

The hardkey "RUN/STOP" allows the user to start the current test independent of the menu selected within the immunity mode.

Pre-conditions:

- loaded system calibration
- loaded probe calibration for the range 9 kHz to 150 kHz
- selected EUT monitoring functions
- Power meter 1 is not needed for the test and should be disconnected from the setup.

During the test the current frequency, test level and trigger events / analog input voltage on EUT monitoring ports are displayed. The analog input voltage (red curve) is related to the left axis. The test level (blue curve) is related to the right axis.

The internal control algorithm provides a maximum deviation of ± 0.1 dB to the used calibration values.

The hardkey "RUN/STOP" allows the user to stop the executed test.

The results can be investigated by turning the rotary knob after the test is finished.

The softkeys "TEST SETUP", "MONITORING SETUP" and "CALIBRATION" are described previously and can also be reached with the softkey "BACK".

4.6.5.1. Immunity menu: Testing with EUT monitoring events

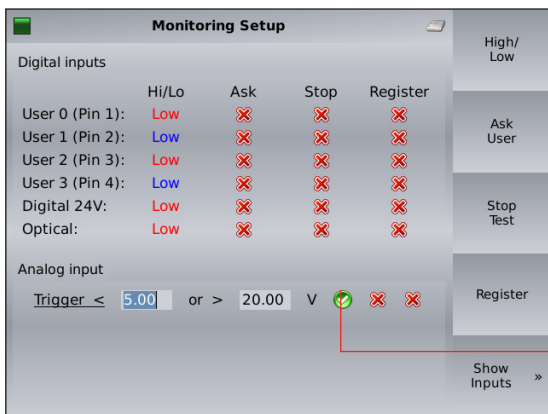

The action in case of a trigger event (EUT failure) can be set either to register the occurrence of the event (lowest priority), to stop the test, or user decision (highest priority) using the corresponding softkeys

Example:

■ If "ASK USER" is selected and an EUT monitoring event occurs:

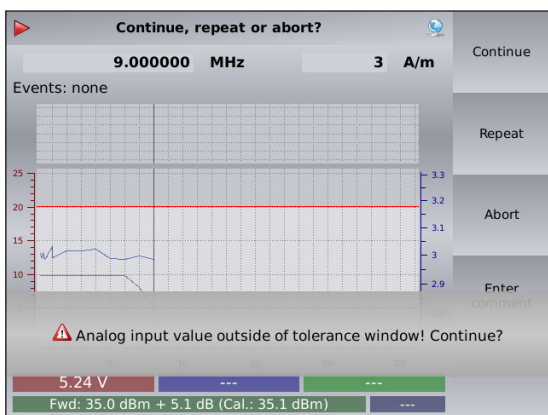

A message box and softkeys come up and the test is interrupted. An user action is required.

Press "CONTINUE" to continue testing.
 Press "REPEAT" to repeat testing on same frequency.
 Press "ABORT" to stop the test.
 Press "ENTER COMMENT" to type in a comment. Press then "BACK" to continue testing.

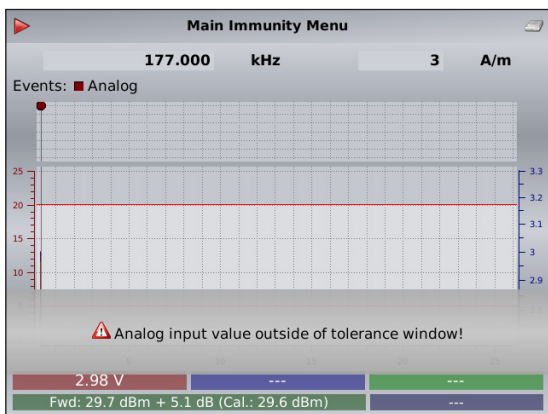

If "REGISTER" is selected, when an EUT monitoring event occurs:

A message box is displayed when the EUT monitoring event has been detected. The test continues.

4.6.5.2. Immunity menu: Testing with manual change of frequency and level

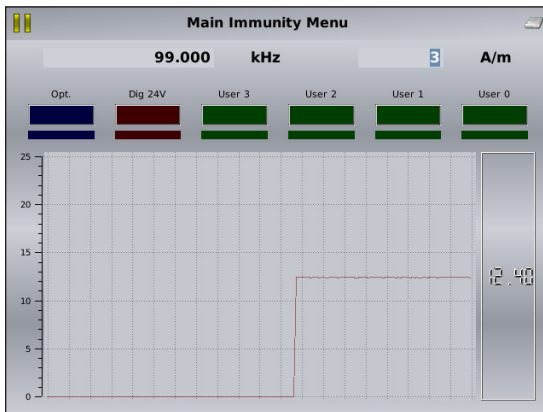

The key "RUN/STOP" allows the user to start the current test and the key "HOLD" interrupts the sweep and the display is changed as shown below:

Pre-conditions:

- system calibration loaded
- probe calibration loaded (all test with monitoring device)
- EUT monitoring functions selected
- power meter 1 for testing above 18 V EMF stress level disconnected

During this mode each monitoring port state is displayed. The color indicates high or low. The smaller field shows the history for the past 5 seconds.

The analog port voltage is displayed with the digits. The graph shows the past 10 seconds of history.

The hardkey "FRQ" allows the user to change the test frequency by the rotary knob. Only the calibrated frequencies can be selected. The hardkey "LVL" allows the user to change the test level with the rotary knob.

The use of the key "HOLD" continues the sweep. The display changes to the previous one.

The key "RUN/STOP" allows the user to stop the test.



Warning: The function "HOLD" interrupts only the sweep. The test level is still present on the output.

4.6.5.3. Immunity menu: Store and recall results

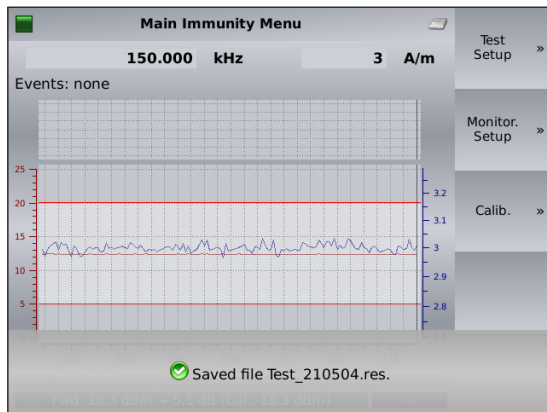
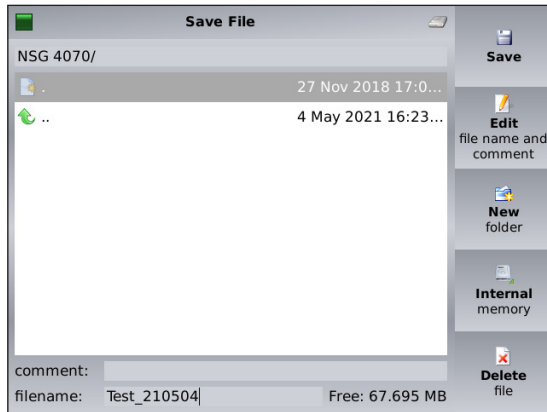

In general the keys “STO” and “RCL” allow the user to store and recall the configurations, calibration data, probe calibration and results.

Store

Pressing the hard key “STO” followed by the softkey “RESULTS” allows the user to save the test results (including test setup and calibration data) to the internal flash or USB stick as file type “.res”. Using the USB stick saves the results additionally in a “.csv” file format. See next page for an example.

The results file includes:

- Start and stop frequency
- Start and stop level
- Sweep parameters
- Coupling device and monitoring probe
- Modulation parameters
- Amplifier internal/external
- EUT monitoring settings
- Forward power versus frequency (calibration data)
- Insertion loss versus frequency (probe calibration data) if probe used
- “FILE COMMENT”

“CHANGE COMMENT”

The file comment allows the user to add information to the results and can be filled out before saving the file.

Recall

Pressing the hard key “RCL” followed by the softkey “RESULTS” allows the user to recall the results from the internal flash or USB stick.

The stored file can be selected by turning the rotary knob.

Firmware version:	V1.00								
Amplifier:	Internal								
Sweep:	Sections	2							
No.	Active	Start frequency in Hz	Stop frequency in Hz	Frequency step	Start level	Stop level	Modulation	Dwell time in ms	
1	0	150000	1.00E+06	100000 Hz	3	3	AM, 1000 Hz, 80 %	2000	
2	1	1.00E+06	2.60E+07	1e+06 Hz	3	3	AM, 1000 Hz, 80 %	2000	
Result over 26 test frequencies:									
No.	Frequency in Hz	Test level	Level unit	Probe current in mA	Forward power in dBm	Reverse power in dBm	Analog input voltage	Events	Comment
1	1000000	3.01478		0	30.0918	-158.396	10.34	0	
2	2000000	3.00378		0	30.5228	-158.712	10.27	0	
3	3000000	3.01243		0	31.2316	-158.688	10.33	0	
4	4000000	3.00249		0	32.0062	-158.569	10.33	0	
5	5000000	2.98503		0	32.8673	-158.548	10.32	0	
6	6000000	2.99121		0	33.6894	-158.527	10.33	0	
7	7000000	2.99391		0	34.4474	-158.497	10.33	0	
8	8000000	2.99192		0	35.1221	-158.467	10.33	0	
9	9000000	3.01254		0	35.7273	-158.453	10.28	0	
10	10000000	3.0276		0	36.3173	-158.488	10.27	0	
11	11000000	2.98452		0	36.9221	-158.444	10.33	0	
12	12000000	2.98719		0	37.4581	-158.447	10.28	0	
13	13000000	2.98971		0	37.9312	-158.45	10.33	0	
14	14000000	2.99989		0	38.3821	-158.501	10.33	0	
15	15000000	2.98247		0	38.8181	-158.504	10.33	0	
16	16000000	3.00131		0	39.2131	-158.505	10.3	0	
17	17000000	2.97767		0	39.5404	-158.46	10.33	0	
18	18000000	3.03093		0	39.9305	-158.463	10.34	0	
19	19000000	3.0063		0	40.3869	-158.466	10.33	0	
20	20000000	3.01275		0	40.7539	-158.469	10.33	0	
21	21000000	3.0271		0	41.0031	-158.474	10.28	0	
22	22000000	2.99423		0	41.326	-158.477	10.33	0	
23	23000000	3.02317		0	41.6291	-158.529	10.29	0	
24	24000000	2.99247		0	41.9776	-158.483	10.31	0	
25	25000000	3.0225		0	42.3411	-158.535	10.33	0	
26	26000000	2.99198		0	42.7526	-158.489	10.33	0	

Table 1: Example of a result in the ".csv" format

4.6.5.4. Immunity menu: Store configurations



Pressing the hard key “STO” followed by the softkey “CONFIG” allows the user to save the configuration to the internal flash or USB stick as file type “.cfg”.



The configuration file includes:

- Remote control settings
- Generator mode settings
- Step button settings
- Start and stop frequency
- Start and stop level
- Sweep parameters
- Coupling device and current clamp
- Modulation parameters
- Amplifier selection
- EUT monitoring settings
- “FILE COMMENT”

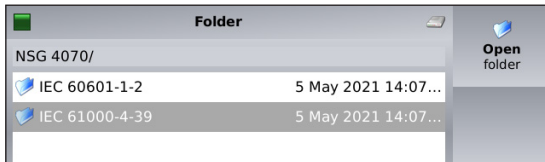

“CHANGE COMMENT”

The file comment allows the user to add information to the results and can be filled out before saving the file.

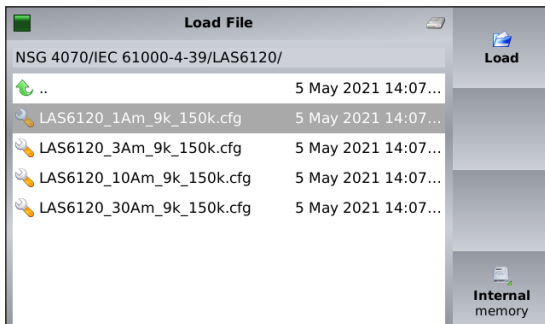
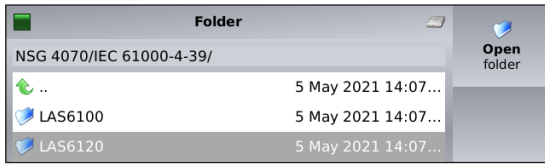

4.7. Generator menu

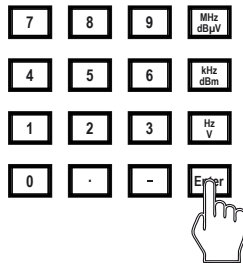
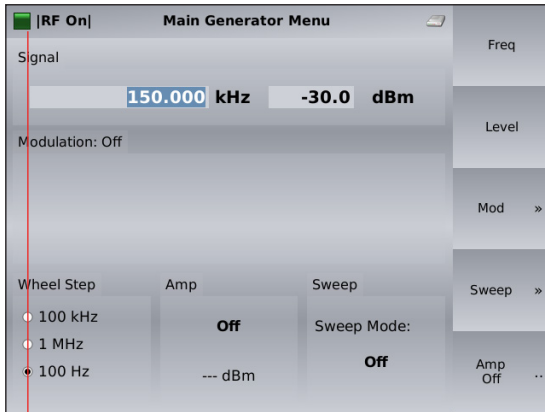

The "MAIN GENERATOR MENU" gives an overview about the current settings of the signal generator.

Frequency and level can be set by hard keys or by softkeys in this menu.

The generator can be switched on/off with the hard key "RF ON/OFF".

The hard key "FRQ" allows the user to change the frequency by the rotary knob (see chapter 4.1.5.4 for changing the step size) or the numeric keyboard.

The hard key "LVL" allows the user to change the test level with the rotary knob or the numeric keyboard.

Numeric input must be terminated with the hard key "ENTER" or with the specified unit key "MHz/dBµV", "kHz/dBm" or "Hz/V". The accepted value is displayed with green background color for a short time.

4.7.1. Generator menu → Modulation

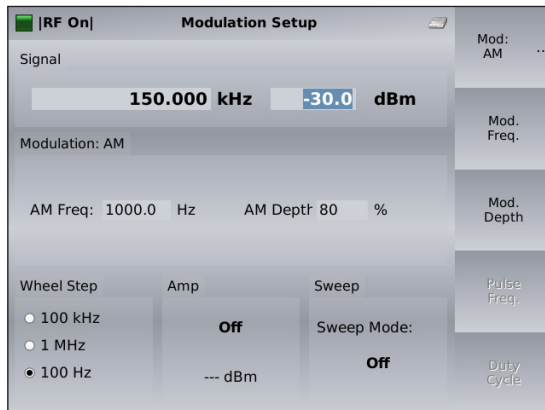

Modulation can be set to AM, pulse modulation, external modulation or off. The modulation can be changed by pressing the upper softkey.

AM: amplitude modulation

PM: pulse modulation

Ext.: external modulation

4.7.2. Generator menu → Sweep



In this menu, different sweeps can be selected and the necessary settings can be made.

The "SECTIONS" function in the "SWEEP MODE" menu can be used to compose test profiles. When this function is selected, the parameters of the activated sections apply. The display changes and shows the sections in tabular form. Start and stop frequency as well as the step width and dwell time from the main menu "sweep setup" are of no importance in this case.

In the submenu "COMMON SETTINGS" further sweep settings are available.

In this menu, the "SINGLE" or "CONTINUOUS" sweep can be selected. The trigger can be set to internal (automatic next step after the dwell time) or external (next step after the trigger signal is applied to the external trigger input) via a softkey. For the external trigger, a connection to the trigger input on the rear of the NSG 4070 is required.

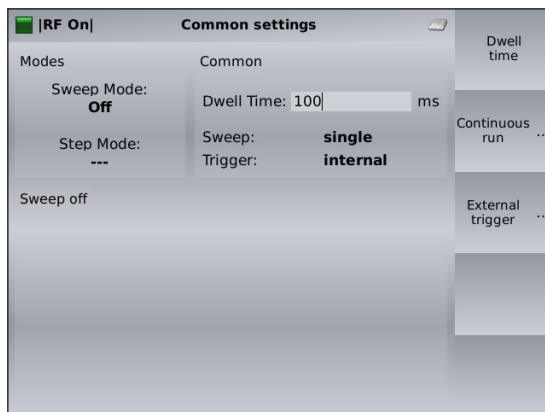

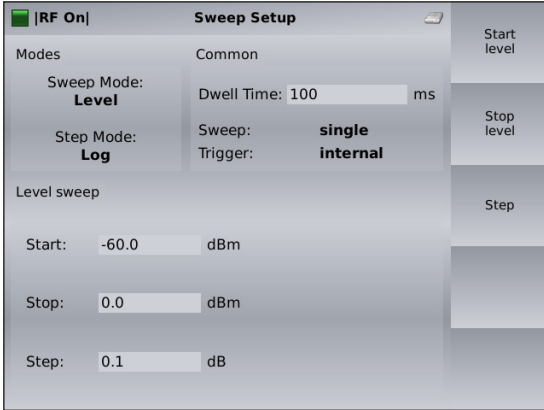

Example for a level sweep.

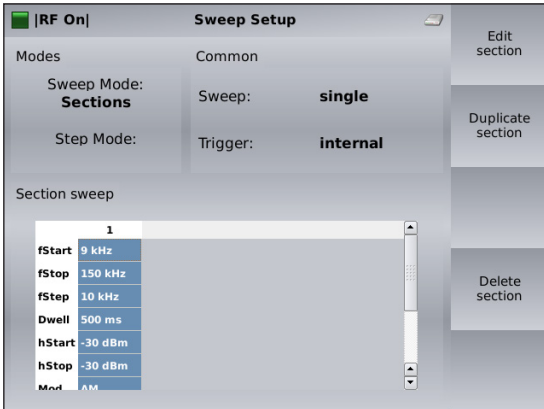

Example for a section sweep.

4.7.3. Generator menu —> Amplifier



The amplifier is turned on by pressing the softkey "AMP ON" in the Main Generator menu. The drive level, or signal generator output level, is limited to 0 dBm when the amplifier is in use. The amplifier output level (forward power) and the signal generator level (amplifier module drive level) are displayed.

 **WARNING:** The power meter inputs are very sensitive. Please avoid any direct connection of amplifier output and power meter input with a high generator level (under these circumstances a maximum generator level of -30 dBm is recommended).

4.8. Device info



“DEVICE INFO” gives general information about serial numbers of the internal components as well as firm-ware versions.

4.8.1. Info → Update firmware

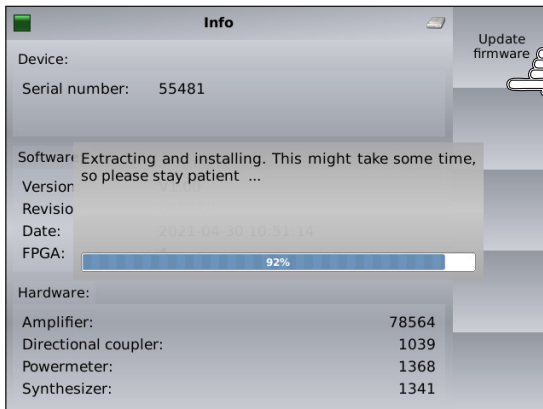

The softkey “UPDATE FIRMWARE” allows the user to update the firmware. The update file needs to be in the root directory of the USB stick. The latest firmware is available from: <https://www.ametek-cts.com/support/updates>

5. REMOTE CONTROL COMMANDS

5.1. Common commands

In the NSG 4070, the following common commands are implemented:

Command	Description
*IDN?	returns the identification string of the device
*RST	resets the NSG 4070 and loads default values
*GTL	switches the device back to local mode

Table 2: Common commands

5.1.1. *IDN?

This command delivers the device's identification string. This string is comprised of the device name and device type (Amplifier Power), the device's serial number and its software version.

***IDN?**

Teseq NSG 4070-80,000123,V1.0

Teseq NSG 4070A-75,000123,V1.0 (For NSG 4070A only. A NSG 4070 can be upgraded to NSG 4070A by replacement of the power meter.)

5.1.2. *GTL

This command switches the device back to the local mode. Front panel operation is then permitted.

***GTL**

5.1.3. *RST

This command resets the receiver and loads the default values. All currently running sweeps are aborted. The synthesizer output and the amplifier are turned off.

***RST**

5.2. The SOURce subsystem

The SOURce subsystem contains all remote control commands that are necessary to modify the output signal of the NSG 4070 when it is used in generator mode.

5.2.1. Set fixed frequency (SOURce:FREQuency:FIXed|CW)

Set the fixed output frequency in generator mode. Values in Hz, kHz and MHz are accepted.

SOURce:FREQuency:FIXed 123.456 Mhz

5.2.2. Set fixed level (SOURce:POWer:LEVel:AMPLitude)

Set the fixed output level in generator mode if RF is on (SOURce:POWer:LEVel:STATe is set). Values in dBm, dBuV and V are accepted.

SOURce:POWer:LEVel:AMPLitude -2.55 dBm

5.2.3. Output On/Off (SOURce:POWer:LEVel:STATe)

Turns output on/off when in generator mode.

SOURce:POWer:LEVel:STATe on

5.2.4. Sweep parameters

The SOURce:SWEEp mode contains all parameters that are required to set up a frequency or a level sweep. Included are the start and stop frequencies/levels, the dwell time for a specific step of a sweep, and the commands to start or abort a sweep.

- Dwell time (SOURce:SWEEp:DWELL)
This sets the dwell time for a frequency or level sweep. The NSG 4070 dwells this time on every step of the sweep. The time can be specified in seconds (s), millisecon. (ms) or microsec. (us).

SOURce:SWEEp:DWELL 1.2 s

Bit	Description
0	if 1 then end of sweep is reached
1	if 1 an error occurred
2	if 1 the sweep was aborted by the user

Table 3: Sweep status byte

- Frequency sweep
The frequency sweep node includes the commands which are necessary to configure and run a frequency sweep.
- Run frequency sweep (SOURce:SWEEp:FREQuency:Run)
This command starts a frequency sweep with the previously configured parameters.
SOURce:SWEEp:FREQuency:Run
- Run frequency sweep query (SOURce:SWEEp:FREQuency:Run?)
This command starts a frequency sweep with the previously configured parameters. Additionally, the current frequency and a status byte are returned for every frequency step. The description of the status byte can be found in table 6.
SOURce:SWEEp:FREQuency:Run?
9000,0
- Abort frequency sweep (SOURce:SWEEp:FREQuency:ABOrt)
This command aborts the currently running frequency sweep.
SOURce:SWEEp:FREQuency:ABOrt
- Start frequency (SOURce:SWEEp:FREQuency:STARt)
This command sets the start frequency of a sweep. The start frequency can be determined in Hz, kHz or MHz.
SOURce:SWEEp:FREQuency:STARt 9000 Hz
SOURce:SWEEp:FREQuency:STARt 15000 kHz
SOURce:SWEEp:FREQuency:STARt 0.15 MHz
- Stop frequency (SOURce:SWEEp:FREQuency:STOP)
This command sets the stop frequency of a sweep. The stop frequency can be determined in Hz, kHz or MHz.
SOURce:SWEEp:FREQuency:STOP 230000000 Hz
SOURce:SWEEp:FREQuency:STOP 80000 kHz
SOURce:SWEEp:FREQuency:STOP 80 MHz

- Step width parameters
The steps for a frequency sweep can be determined in either a linear mode with fixed step sizes, in numbers of steps per decade or as a percent increment.
- Linear step width (SOURCE:SWEEP:FREQUENCY:STEP:LINEAR)
This command configures a linear frequency sweep with a fixed step size. The step size can be configured in HZ, KHZ or MHZ.
SOURCE:SWEEP:FREQUENCY:STEP:LINEAR 10000 Hz
- Decade step width (SOURCE:SWEEP:FREQUENCY:STEP:DECADe)
This command configures a decade sweep with x steps per frequency decade. The example below shows how to set up a sweep with 11 steps per decade.
SOURCE:SWEEP:FREQUENCY:STEP:DECADe 11
- Percental step width (SOURCE:SWEEP:FREQUENCY:STEP:PERCENT)
This command configures a percent sweep with a frequency increase of x% per step. The next frequency steps are calculated as follows:

$$f_{next} = f_{current} + x * \frac{f_{current}}{100}$$

where x stands for the percental increase.

SOURCE:SWEEP:FREQUENCY:STEP:PERCENT 2.5

- Level sweep
The level sweep node includes the commands which are necessary to configure and run a level sweep.
- Run level sweep (SOURCE:SWEEP:LEVEL:RUN)
Use this command to trigger a level sweep.
SOURCE:SWEEP:LEVEL:RUN
- Run level sweep query (SOURCE:SWEEP:LEVEL:RUN?)
This command starts a level sweep with the previously configured parameters. Additionally, the current level and a status byte are returned for every step. The description of the status byte can be found in table 5.6.2.
SOURCE:SWEEP:LEVEL:RUN?
-30.0,0
- Abort level sweep (SOURCE:SWEEP:LEVEL:ABORT)
The ABORT command cancels a currently running level sweep and switches the synthesizer output back to a continuous wave (if no modulation is selected).
SOURCE:SWEEP:LEVEL:ABORT
- Set the start level (SOURCE:SWEEP:LEVEL:START)
This command sets the start level of a level sweep in dBm.
SOURCE:SWEEP:LEVEL:START -40 dBm
- Set the stop level (SOURCE:SWEEP:LEVEL:STOP)
This command sets the stop level of a level sweep in dBm.
SOURCE:SWEEP:LEVEL:STOP 5 dBm

- Set the step width (SOURCE:SWEep:LEVel:STEp)

This command sets the step width for each level step during a sweep in dBm.

SOURCE:SWEep:LEVel:STEp 0.5 dBm
- Continuous sweep setup (SOURCE:SWEep:CONTInuous)

If this option is set, the frequency or level sweep is running continuously. After reaching the stop frequency/level the sweep is restarted. The following arguments to this command are accepted:

 - true|false
 - yes|no
 - 1|0
 - on|off

SOURCE:SWEep:LEVel:CONTInuous on
- Trigger setup (SOURCE:SWEep:TRIGger)

There are two ways to trigger each sweep step when running a sweep:

 1. internal trigger (wait for the configured dwell time)
 2. external trigger (use the trigger input on the rear panel)

The following arguments to this command are accepted:

 - int|ext
 - intern|extern
 - internal|external

SOURCE:SWEep:LEVel:TRIGger external

5.2.5. Modulation parameters (SOURCE:MODulation)

The SOURCE:MODulation node contains all parameters that are required to set up a modulated output signal. The NSG 4070 supports amplitude modulation, pulse modulation, and external amplitude modulation.

- Modulation mode setup (SOURCE:MODulation:MODE)

This command determines the kind of modulation which is applied to the output signal. The following arguments to this command are accepted:

AM – Amplitude Modulation
 Pulse – Pulse Modulation
 Ext – External AM
 Off – unmodulated CW signal

SOURCE:MODulation:MODE AM
- AM parameters setup (SOURCE:MODulation:AM)

This mode contains the commands to configure an AM modulated signal.
- AM frequency setup (SOURCE:MODulation:AM:FREQuency)

This command sets the modulation frequency.

SOURCE:MODulation:AM:FREQuency 1 kHz
- AM depth setup (SOURCE:MODulation:AM:DEPth)

This command sets the modulation depth in percent.

SOURCE:MODulation:AM:DEPth 80
- Pulse parameters setup (SOURCE:MODulation:PULSE)

This mode contains the commands to configure a pulse modulated signal.

- Pulse frequency setup (SOURCE:MODulation:PULSE:FREQUENCY)
This command sets the modulation frequency.
SOURCE:MODulation:PULSE:FREQUENCY 2 Hz
- Pulse duty cycle setup (SOURCE:MODulation:PULSE:DUTY)
This command sets the duty cycle of the pulse modulation in percent.
SOURCE:MODulation:PULSE:DUTY 50

5.3. The power meter subsystem

The POWERmeter subsystem contains remote control commands to read the power meter channels of the NSG 4070. The device provides 3 external channels and 1 internal channel that is used to measure the forward power on the amplifier output.

5.3.1. Channel 1 (POWERmeter:Channel1?)

Measures the power on channel 1 of the built in power meter. A value in dBm is returned. There is an optional frequency parameter to this command. It specifies the frequency of the signal to be measured. If the frequency parameter is omitted, the output frequency of the NSG 4070 signal generator part is used.

POWERmeter:Channel1? 100 MHz
-12.33 dBm

5.3.2. Channel 2 (POWERmeter:Channel2?)

Measures the power on channel 2 of the built in power meter.

POWERmeter:Channel2? 100 MHz
5.23 dBm

5.3.3. Channel 3 (POWERmeter:Channel3?)

Measures the power on channel 3 of the built in power meter.

POWERmeter:Channel3? 100 MHz
0.57 dBm

5.3.4. Forward power (POWERmeter:FORWARD?)

Measures the forward power on the amplifier output of the NSG 4070. Note that this value does not take the internal directional coupler into account. To get the output level at the Amp out socket you have to add the insertion loss of the internal directional coupler. You can obtain the insertion loss of the internal directional coupler with the command **MISCellaneous:DIRCOUP?**

POWERmeter:FORWARD? 100 MHz
25.23 dBm

5.4. The amplifier subsystem

5.4.1. Amplifier On / Off (AMPLIFIER)

Turns the internal amplifier on or off when the device is used in generator mode.

AMPLIFIER on

5.5. The monitor subsystem

The MONitor subsystem contains remote control commands that let the user read in the various monitoring inputs. Additionally the user can set the digital outputs on the user port (user output 0-3) to the desired TTL level.

5.5.1. Analog input (MONitor:ANALog?)

Reads in the voltage on the analog input on the rear panel of the NSG 4070. A value in Volts is returned.

MON:ANA?
3.33 V

5.5.2. Digital input (MONitor:DIGital?)

Reads all digital inputs on the rear panel of the NSG 4070 and returns a byte with a bit for each input set. Please see Table 7 for the structure of the returned byte. See Chapter 3.2.2 Back panel for the pin assignment of the user port.

MON:DIG?

12

Bit	Input
0	User Input 0
1	User Input 1
2	User Input 2
3	User Input 3
4	-
5	Digital Input 24 V
6	Optical Input

Table 4: Digital monitoring inputs

5.5.3. Digital outputs

The NSG 4070 has 4 digital outputs which can be used for control purposes when the device is embedded in a test bench. These outputs are user output 0-3 on the user port. They can be set to TTL level.

The following arguments are accepted: high/low, on/off, 1/0, true/false, yes/no and auto.

The function Auto is explained in chapter 7. See Chapter 3.2.2 Back panel for the pin assignment of the user port.

- User output 0 (MONitor:UserOUT0)
Sets the user output 0 to the desired level.
MON:UOUT0 high
- User output 1 (MONitor:UserOUT1)
Sets the user output 1 to the desired level.
MON:UOUT1 high
- User output 2 (MONitor:UserOUT2)
Sets the user output 2 to the desired level.
MON:UOUT2 high
- User output 3 (MONitor:UserOUT3)
Sets the user output 3 to the desired level.
MON:UOUT3 high

5.6. The MISCellaneous subsystem

The MISCellaneous subsystem contains remote control commands that are useful but may not fit into other subsystems. Most of the commands in this node yield information about files stored on the device.

5.6.1. File information

Some commands that deliver useful information about files stored on the NSG 4070:

- List system calibration files (MISCellaneous:FILES:CALibration?)
This command returns all calibration files available on the device. The individual file names are separated with a semicolon “;”.

MISCellaneous:FILES:CALibration?
cdn.cal;emclamp.cal;foo.cal;bar.cal
- List probe calibration files (MISCellaneous:FILES:MONitoring?)
This command returns all monitoring probe calibration files available on the device. The individual file names are separated with a semicolon “;”.

MISCellaneous:FILES:MONitoring?
probe1.mon;foo.mon;bar.mon
- List result files (MISCellaneous:FILES:RESult?)
This command returns all result files available on the device. The individual file names are separated with a semicolon “;”.

MISCellaneous:FILES:RESult?
foo.res;bar.res
- List config files (MISCellaneous:FILES:CONFig?)
This command returns all configuration files available on the device. The individual file names are separated with a semicolon “;”. Alternatively MISCellaneous:FILES:CFG? can be used.

MISCellaneous:FILES:CFG?
foo.cfg;bar.cfg
- Get file comment (MISCellaneous:FILES:COMMent?)
This command returns the file comment for a particular file.

MISCellaneous:FILES:COMMent? foo.cfg
This cfg is for IEC 61000-4-6 Level 1
- Get amplifier frequency response (MISCellaneous:AMPlifier?)
This command returns the frequency response of the internal amplifier in the following format: frequency[Hz],gain[dB];frequency[Hz],gain[dB]...
The string ends with a newline character. Note: There is no newline character between the separate nodes.

MISCellaneous:AMPlifier?
9000,-19.34;...;1000000,54.12;...;230000000,53.34;new line
- Get directional coupler coupling factor (MISCellaneous:DIRectionalCOUPler?)
This command returns the coupling factor over frequency of the internal directional coupler in the following format: frequency[Hz],forward loss[dB], reverse loss[dB];frequency[Hz],loss[dB]...
The string ends with a newline character.

MISCellaneous:DIRCOUP?
9000,40.34,40.03;...;1000000,37.12,38.45;new line
Units without internal reverse power measurement return -99.00. See following example:
9000,40.34,-99.00;...;1000000,37.12,-99.00;new line

5.7. The Service subsystem

The Service subsystem contains remote control commands that are useful service.

- Outputs the value that actually comes out at the Amp Out. The correction data of the directional coupler are taken into account.

Service:POWERmeter:AmpOUT?

Service:POWERmeter:AOUT?

6. ESTABLISHING THE REMOTE CONNECTION

The following example shows how to set up the NSG 4070 for use with the Windows-based remote control program. Further examples are based on the steps shown in this example.

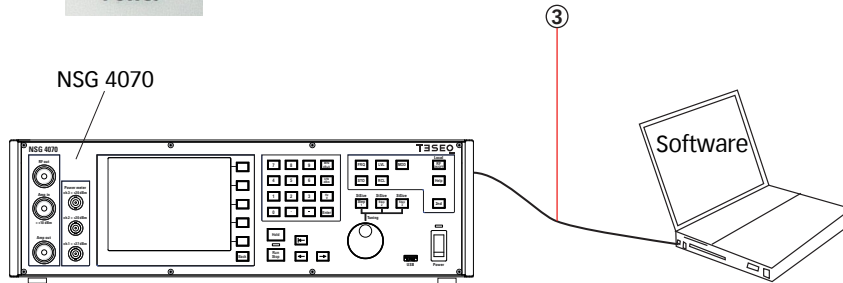
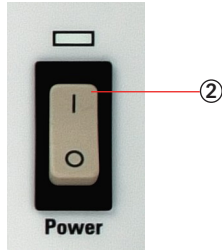
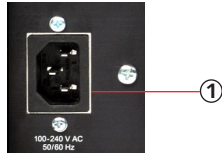

1. Connect the NSG 4070 with a suitable mains socket.
2. Switch the unit on.
3. Connect the NSG 4070 and USO 4013 to the PC.
4. Press "SETUP".
5. Press "REMOTE".
6. Press "REMOTE INTERFACE".



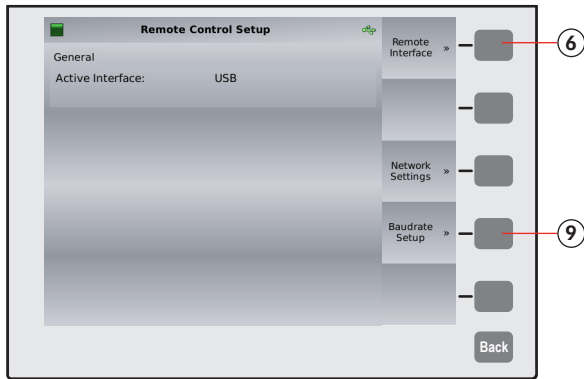

7. Press "RS232 OPTICAL".
8. Press "BACK"
9. Press "BAUDRATE SETUP"
10. Change the settings as required. (Default value is 11500 Baud)
11. Connect the NSG 4070, USO 4013 and PC as shown in the figure.
12. The device manager under Windows 10

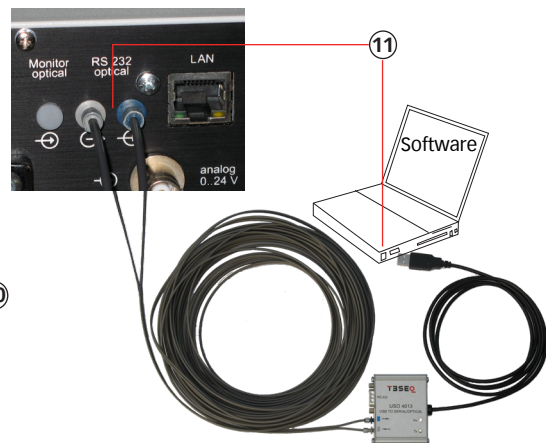
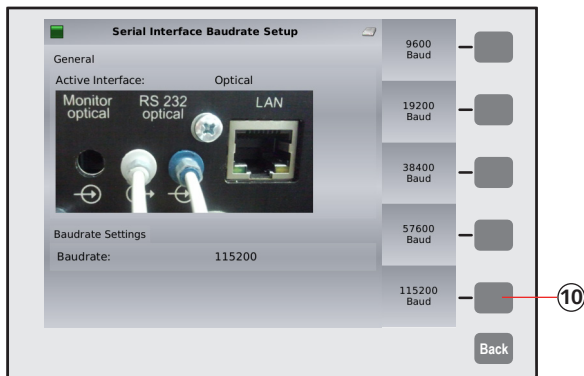
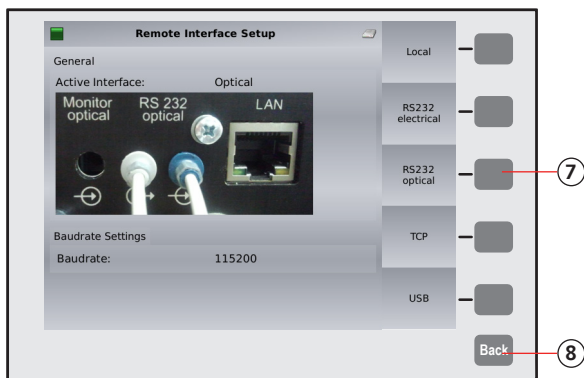

- ▼ Anschlüsse (COM & LPT)
 - ECP-Druckeranschluss (LPT1)
 - Intel(R) Active Management Technol
 - Kommunikationsanschluss (COM1)
 - Serielles USB-Gerät (COM18)
 - Teseq USO 4013 (COM4) ———— 12

shows the USO 4013 after successful driver installation. The port number, in the example COM 4, must be entered in the application software.

7. ADVANCED USE OF EUT MONITORING PORTS

7.1. Digital outputs

The NSG 4070 has 4 digital outputs which can be used for control purposes when the device is embedded in a EUT monitoring setup. These outputs are supplied on user port pin 6 to 9. In local operation mode the unit works in "auto" mode. A default behavior is applied to these outputs during an immunity test. In remote operation mode the outputs can be set individually. A deactivated User port output D0 works in the "auto" mode.

7.1.1. "Auto" mode

This mode provides a "high" level on User port output D0 during the dwell time and falls to "low" level only during the setting time for the next frequency. The timing is shown in the next figure:

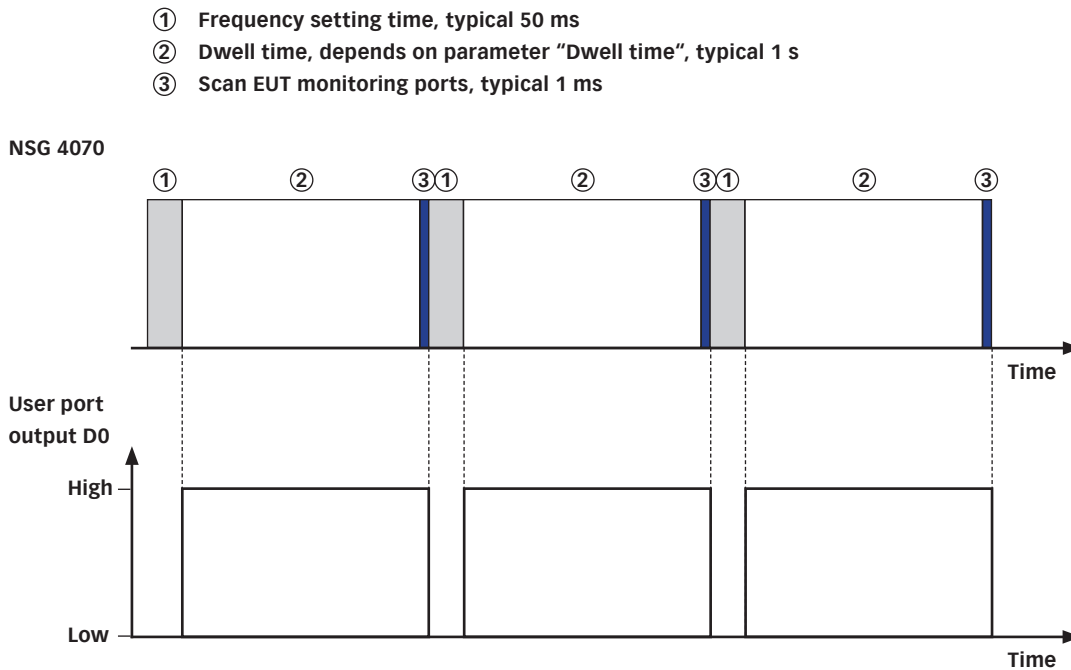

Figure 4: Timing of User port D0 output in "auto" mode

7.1.2. Monitoring event

The function "Monit. Event" changes the output level for every EUT monitoring event on the selected output port. Available are: "Low", "High", "LowImp" and "HighImp".

7.1.3. Frequency step

The function "Every step" changes the output level for every frequency step on the selected output port. Available are: "LowImp" and "HighImp".

7.1.4. Switching at a defined frequency

The function "at Fr1"/"at Fr2" changes the output level at a defined frequency (frequency in MHz) on the selected output port. Available are: "Low", "High", "LowImp" and "HighImp".

Note:

Use D3 "low" to switch MD 4070 into the passive mode and "high" to switch into the active mode.

Use D2 "low" to switch SW 4070 to path 1 and "high" to switch to path 2.

The function is disabled during performing the system and probe calibration.

7.1.5. Switching at test start

The function "at Test Start" changes the output level at test start on the selected output port. Available are: "LowImp" and "HighImp".

8. APPLICATION AND STANDARD REQUIREMENTS

8.1. Frequency range 9 kHz to 150 kHz

The NSG 4070C1/C2-LFCP together with the Loop Antenna Set LAS 6120 are designed to generate and verify magnetic fields in close proximity to test the immunity of electrical equipment exposed to RF fields as required by the standards IEC 61000-4-39 and IEC 60601-1-2.

The LAS 6120 antenna set consists of a radiating loop antenna RLA 6120-20, field sensor loop FSL 6040-51 and a current sensor CSP 9160A, and guarantees the required distance of 50 mm needed to comply with the standard requirements.

FSL 6040-51 loop sensor with a diameter of 40 mm, offers electrostatic shielding and is supplied with the correction factor.

8.1.1. Test level setting

For the operation of the Loop Antenna Set LAS 6120, the correct test level must be performed in the setup shown below before the actual test.

1. Connect the amplifier output via the N to BNC adapter and BNC to banana adapter with the banana cable to the transmitting antenna.
2. Feed one conductor of the banana cable through the current clamp (Do not lead both conductors through the current clamp!). Connect the current clamp via the BNC cable with the power meter. The current clamp must be connected to power meter channel 2 of the NSG 4070C1/C2-LFCP.
3. Move the receive antenna to the 5 cm distance from the transmit antenna using the spacer.
4. Connect the receiving antenna with the BNC cable to the power meter channel 1 of NSG 4070C1/C2-LFCP.
5. Configure the test parameters in the software. Avoid damaging the power meters by calculating the expected levels beforehand. Use attenuators if necessary. Use the valid correction factors for current probe and receive antenna.
6. Perform the test level setting procedure save the result.

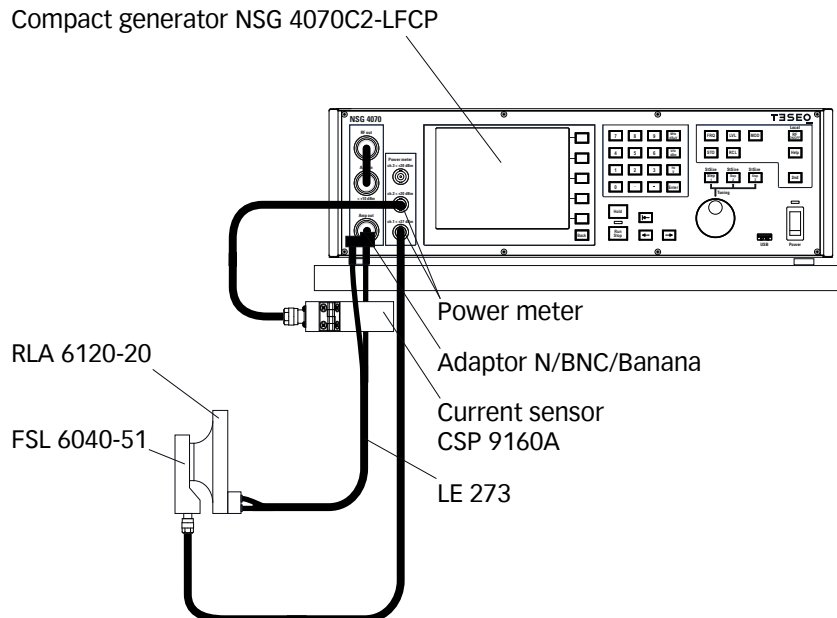

Figure 5: Set up example for test level setting

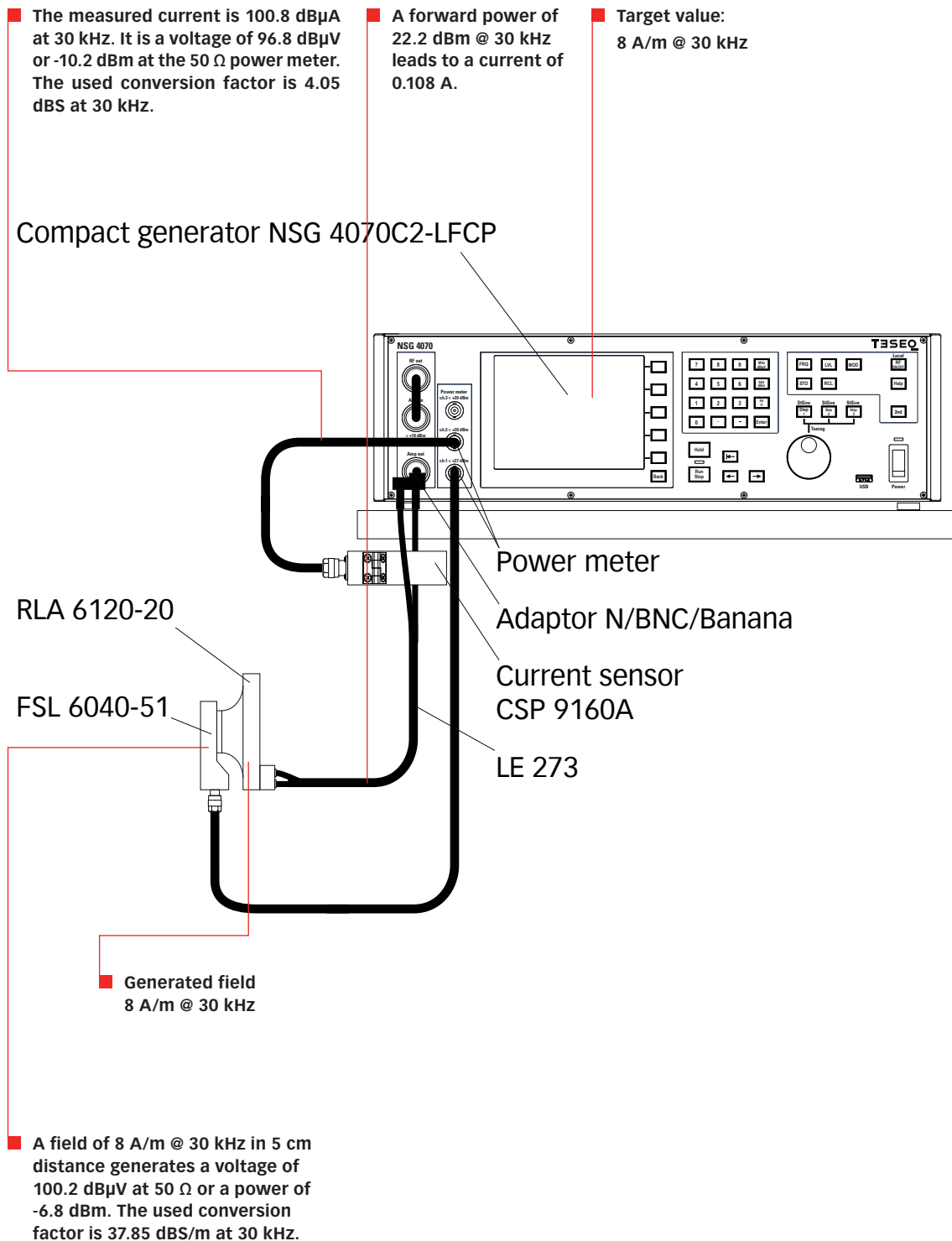

Figure 6: Example for test level setting

8.1.3. Influence of the distance on the magnetic field strength

The following table shows the influence of the distance on the magnetic field strength. From this, conclusions can be drawn about the measurement uncertainty. Furthermore, the table helps to estimate the danger on the human body, e.g. when the antenna is held in the hand. For example, the Federal Office for Radiation Protection in Germany limits (26.BIMSCHV) a magnetic flux density of 27 μT above 3 kHz. Based on the example shown below, the user's hand would have to be at least 10 cm away from the antenna.



Avoid staying in the immediate vicinity of the antenna at field strengths above permissible values for the human body. For hand-held positioning, increase the distance to the antenna by suitable means (Use of the TPF 6120 tripod holder and, if necessary, extension with e.g. a wooden rod.). Note the dependencies in the table shown below.

Current in A	Distance in m	Field strength in A/m	Field strength in dB $\mu\text{A}/\text{m}$	Magnetic flux density in μT
1	0	166.67	164.44	208.33
1	0.01	159.96	164.08	199.94
1	0.02	142.30	163.06	177.88
1	0.03	119.26	161.53	149.07
1	0.04	96.01	159.65	120.01
1	0.05	75.56	157.57	94.45
1	0.06	58.93	155.41	73.66
1	0.07	45.94	153.24	57.42
1	0.08	36.00	151.13	45.00
1	0.09	28.45	149.08	35.56
1	0.1	22.70	147.12	28.37
1	0.11	18.30	145.25	22.88
1	0.12	14.91	143.47	18.63
1	0.13	12.27	141.77	15.33
1	0.14	10.19	140.16	12.73
1	0.15	8.54	138.63	10.67
1	0.16	7.21	137.16	9.02
1	0.17	6.14	135.77	7.68
1	0.18	5.27	134.44	6.59
1	0.19	4.55	133.16	5.69
1	0.2	3.95	131.94	4.94
1	0.21	3.46	130.77	4.32
1	0.22	3.04	129.65	3.79
1	0.23	2.68	128.56	3.35
1	0.24	2.38	127.52	2.97
1	0.25	2.12	126.52	2.65

Table 5: Calculated field strength deviation in relation to the distance

8.1.4. Expected correlations for selected test levels

Frequency in MHz	Field strength in A/m	Correction factor FSL 6040-51 in dBS/m	FSL 6040-51 on power meter in dBµV	FSL 6040-51 on power meter in dBm	CSP 9160A on power meter in dBm	CSP 9160A on power meter in dBµV	Correction factor CSP 9160A in dBS	Current in dBµA	Current in A
0.009	1	47.4	72.6	-34.4	-36.6	70.4	12.5	82.9	0.01
0.01	1	46.5	73.5	-33.5	-35.7	71.3	11.6	82.9	0.01
0.02	1	40.9	79.1	-27.9	-30.7	76.3	6.5	82.8	0.01
0.03	1	37.8	82.2	-24.8	-28.3	78.7	4.1	82.8	0.01
0.04	1	36.0	84.0	-23.0	-27.1	79.9	2.7	82.7	0.01
0.05	1	34.7	85.3	-21.7	-26.4	80.6	2.0	82.6	0.01
0.06	1	33.9	86.1	-20.9	-26.0	81.0	1.5	82.5	0.01
0.07	1	33.2	86.8	-20.2	-25.8	81.2	1.2	82.5	0.01
0.08	1	32.8	87.2	-19.8	-25.6	81.4	1.0	82.4	0.01
0.09	1	32.4	87.6	-19.4	-25.5	81.5	0.9	82.4	0.01
0.1	1	32.2	87.8	-19.2	-25.3	81.7	0.8	82.4	0.01
0.11	1	32.0	88.0	-19.0	-25.3	81.7	0.7	82.3	0.01
0.12	1	31.8	88.2	-18.8	-25.3	81.7	0.6	82.4	0.01
0.13	1	31.7	88.3	-18.7	-25.3	81.7	0.6	82.3	0.01
0.14	1	31.6	88.4	-18.6	-25.2	81.8	0.5	82.3	0.01
0.15	1	31.5	88.5	-18.5	-25.2	81.8	0.5	82.2	0.01

Table 6: Expected correlations for test level 1 A/m

Frequency in MHz	Field strength in A/m	Correction factor FSL 6040-51 in dBS/m	FSL 6040-51 on power meter in dBµV	FSL 6040-51 on power meter in dBm	CSP 9160A on power meter in dBm	CSP 9160A on power meter in dBµV	Correction factor CSP 9160A in dBS	Current in dBµA	Current in A
0.009	3	47.4	82.1	-24.9	-27.1	79.9	12.5	92.4	0.04
0.01	3	46.5	83.0	-24.0	-26.2	80.8	11.6	92.4	0.04
0.02	3	40.9	88.7	-18.3	-21.1	85.9	6.5	92.4	0.04
0.03	3	37.8	91.7	-15.3	-18.7	88.3	4.1	92.3	0.04
0.04	3	36.0	93.6	-13.4	-17.5	89.5	2.7	92.2	0.04
0.05	3	34.7	94.8	-12.2	-16.9	90.1	2.0	92.1	0.04
0.06	3	33.9	95.7	-11.3	-16.5	90.5	1.5	92.1	0.04
0.07	3	33.2	96.3	-10.7	-16.2	90.8	1.2	92.0	0.04
0.08	3	32.8	96.8	-10.2	-16.0	91.0	1.0	92.0	0.04
0.09	3	32.4	97.1	-9.9	-15.9	91.1	0.9	92.0	0.04
0.1	3	32.2	97.4	-9.6	-15.8	91.2	0.8	92.0	0.04
0.11	3	32.0	97.6	-9.4	-15.8	91.2	0.7	91.9	0.04
0.12	3	31.8	97.7	-9.3	-15.7	91.3	0.6	91.9	0.04
0.13	3	31.7	97.9	-9.1	-15.7	91.3	0.6	91.9	0.04
0.14	3	31.6	98.0	-9.0	-15.7	91.3	0.5	91.8	0.04
0.15	3	31.5	98.1	-8.9	-15.7	91.3	0.5	91.8	0.04

Table 7: Expected correlations for test level 3 A/m

Frequency in MHz	Field strength in A/m	Correction factor FSL 6040-51 in dBS/m	FSL 6040-51 on power meter in dBµV	FSL 6040-51 on power meter in dBm	CSP 9160A on power meter in dBm	CSP 9160A on power meter in dBµV	Correction factor CSP 9160A in dBS	Current in dBµA	Current in A
0.009	10	47.4	92.6	-14.4	-16.6	90.4	12.5	102.9	0.14
0.01	10	46.5	93.5	-13.5	-15.7	91.3	11.6	102.9	0.14
0.02	10	40.9	99.1	-7.9	-10.7	96.3	6.5	102.8	0.14
0.03	10	37.8	102.2	-4.8	-8.3	98.7	4.1	102.8	0.14
0.04	10	36.0	104.0	-3.0	-7.1	99.9	2.7	102.7	0.14
0.05	10	34.7	105.3	-1.7	-6.4	100.6	2.0	102.6	0.13
0.06	10	33.9	106.1	-0.9	-6.0	101.0	1.5	102.5	0.13
0.07	10	33.2	106.8	-0.2	-5.8	101.2	1.2	102.5	0.13
0.08	10	32.8	107.2	0.2	-5.6	101.4	1.0	102.4	0.13
0.09	10	32.4	107.6	0.6	-5.5	101.5	0.9	102.4	0.13
0.1	10	32.2	107.8	0.8	-5.3	101.7	0.8	102.4	0.13
0.11	10	32.0	108.0	1.0	-5.3	101.7	0.7	102.3	0.13
0.12	10	31.8	108.2	1.2	-5.3	101.7	0.6	102.4	0.13
0.13	10	31.7	108.3	1.3	-5.3	101.7	0.6	102.3	0.13
0.14	10	31.6	108.4	1.4	-5.2	101.8	0.5	102.3	0.13
0.15	10	31.5	108.5	1.5	-5.2	101.8	0.5	102.2	0.13

Table 8: Expected correlations for test level 10 A/m

Frequency in MHz	Field strength in A/m	Correction factor FSL 6040-51 in dBS/m	FSL 6040-51 on power meter in dBµV	FSL 6040-51 on power meter in dBm	CSP 9160A on power meter in dBm	CSP 9160A on power meter in dBµV	Correction factor CSP 9160A in dBS	Current in dBµA	Current in A
0.009	30	47.4	102.1	-4.9	-7.1	99.9	12.5	112.4	0.42
0.01	30	46.5	103.0	-4.0	-6.2	100.8	11.6	112.4	0.42
0.02	30	40.9	108.7	1.7	-1.1	105.9	6.5	112.4	0.41
0.03	30	37.8	111.7	4.7	1.3	108.3	4.1	112.3	0.41
0.04	30	36.0	113.6	6.6	2.5	109.5	2.7	112.2	0.41
0.05	30	34.7	114.8	7.8	3.1	110.1	2.0	112.1	0.40
0.06	30	33.9	115.7	8.7	3.5	110.5	1.5	112.1	0.40
0.07	30	33.2	116.3	9.3	3.8	110.8	1.2	112.0	0.40
0.08	30	32.8	116.8	9.8	4.0	111.0	1.0	112.0	0.40
0.09	30	32.4	117.1	10.1	4.1	111.1	0.9	112.0	0.40
0.1	30	32.2	117.4	10.4	4.2	111.2	0.8	112.0	0.40
0.11	30	32.0	117.6	10.6	4.2	111.2	0.7	111.9	0.39
0.12	30	31.8	117.7	10.7	4.3	111.3	0.6	111.9	0.39
0.13	30	31.7	117.9	10.9	4.3	111.3	0.6	111.9	0.39
0.14	30	31.6	118.0	11.0	4.3	111.3	0.5	111.8	0.39
0.15	30	31.5	118.1	11.1	4.3	111.3	0.5	111.8	0.39

Table 9: Expected correlations for test level 30 A/m

Fre- quency in MHz	Field strength in A/m	Cor- rection factor FSL 6040-51 in dBS/m	FSL 6040-51 on power meter in dBμV	FSL 6040-51 on power meter in dBm	CSP 9160A on power meter in dBm	CSP 9160A on power meter in dBμV	Cor- rection factor CSP 9160A in dBS	Current in dBμA	Current in A
0.03	8	37.8	100.2	-6.8	-10.2	96.8	4.1	100.8	0.11
0.1342	65	31.6	124.6	17.6	11.0	118.0	0.6	118.6	0.85

Table 10: Expected correlations for test level 8 A/m at 30 kHz and 65 A/m at 134.2 kHz

8.1.5. Power requirements

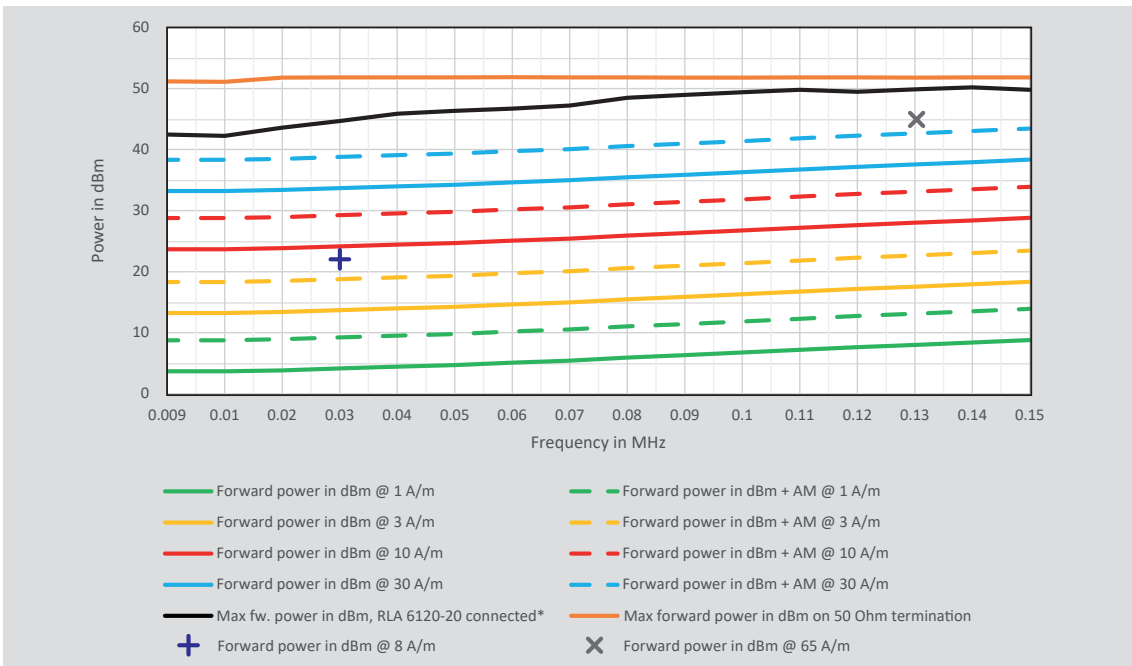

* The display of the forward power via a 50 Ohm power meter at the directional coupler is distorted by the strong mismatch. It can therefore only be used to a limited extent. Likewise, the output power of an amplifier is dependent on the connected load.

Figure 8: Example for typical power requirements using NSG 4070C1/C2-LFCP

8.1.6. Modulation

The level setting procedure of IEC / EN 61000-4-39 is done without any modulation. The modulation is switched on during testing. In the frequency range 9 kHz to 150 kHz is required the amplitude modulation with a depth of 80%. The peak value of the envelope of the amplitude modulated signal is increased against the CW signal. See figure below.

Example: AM with 80% requires 5.1 dB additional power as used for the level setting procedure.

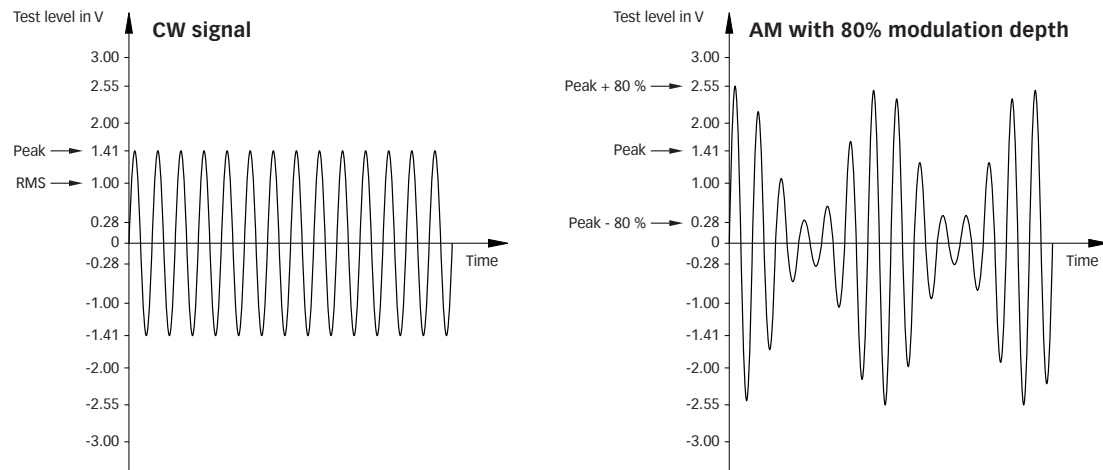

Figure 9: Amplitude modulation

8.1.7. Saturation check

This function allows the user to check whether there is sufficient power available for the selected modulation required, even if the system calibration is always performed without modulation. Special high test levels could bring the power amplifier into saturated range if the modulation (e.g. AM with 80% needs 5.1 dB more power) is switched on during EUT testing. The check requires a loaded calibration file. The forward power of the calibration is increased with 5.1 dB during the check.

See chapter 4.6.3.2 for details.

8.1.8. Current probe

A current clamp is required to set the current. The field strength achieved by the field probe is proportional to the set current. The calculation of the current via the forward power is not used due to the poor matching in the range 9 kHz to 150 kHz. Apart from the frequency range, the current probe used must be suitable for the level range of the measurement task as well as the power meter.

The correction factors of the current clamp can be measured via the "Probe calibration" function. The probe calibration measures the insertion loss in a 50 Ω system. See next page for details.

An import of data in the text format is also possible. See Chapter 4.6.2.

8.1.9. Calibration jig

For the "Probe Calibration" function, the current probe must be inserted into a suitable calibration device to allow the 50 ohm impedance to be as close as possible.

8.1.10. Probe calibration

The correction factors of the current clamp can be measured via the "Probe calibration" function. The probe calibration measures the insertion loss in a 50 Ω system.

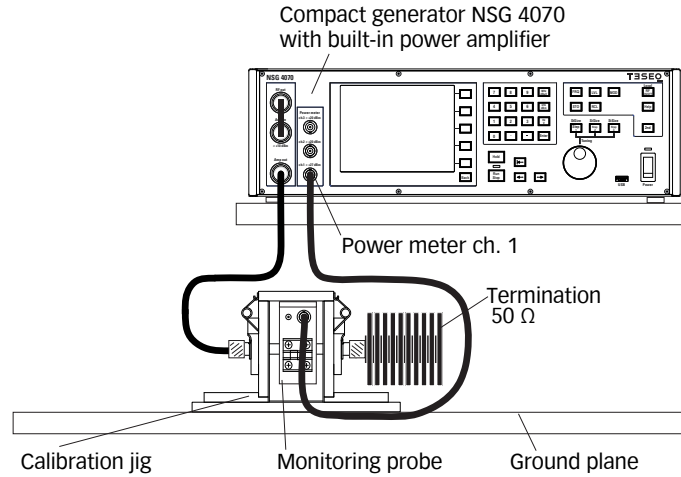

Figure 10: Probe calibration setup

8.1.11. Power meter

Channel 1 is used for measuring the stress level (field strength) during the system calibration. The power meter channel 1 must be protected with an appropriate 50 Ω attenuator if the interference level plus the control tolerance reaches the power limit of 27 dBm. Channel 1 is also used for insertion loss measurement of the "Probe Calibration" function. Power meter channel 2 is used to measure the current.

8.1.12. Attenuator

Attenuators should be used at high levels to protect the power meters. For channel 1 the value of the attenuator can be set in the menu: Setup->Power Limits can be taken into account by the parameter "Additional Att.

8.1.13. Optically decoupled remote control

The converter USO 4013 allows the remote control of the NSG 4070 via a 20 m Polymeric Optical Fiber (POF). The USO 4013 connects the optical remote interface of the NSG 4070 with the USB interface of the control PC.

8.1.14. Test facility

The tests should be performed in a suitable, preferably shielded test environment. During calibration and testing, a sufficient distance (1 m) should be kept from metallic surfaces, apart from the DUT, etc. See also notes in IEC 61000-4-39.

8.2. Frequency range 150 kHz to 26 MHz

The NSG 4070C1/C2-LFCP and the Loop Antenna Set LAS 6100 are designed to generate and verify magnetic fields in close proximity to test the immunity of electrical equipment exposed to RF fields as required by the IEC 61000-4-39 and IEC 60601-1-2.

The LAS 6100 antenna set consists of a radiating loop antenna RLA 6100-3 and field sensor loop FSL 6040-1. It guarantees the required distance of 50 mm needed to comply with the standard requirements.

FSL 6040-1 field loop sensor with a diameter of 40 mm, offers electrostatic shielding. The correction factor is also provided with the FSL 6040-1.

The LAS 6100 set includes the ANP 4039 adaptor to allow more field strength at 13.56 MHz, as required by IEC 60601-1-2.

8.2.1. Test level setting for the whole frequency range

For the operation of the Loop Antenna Set LAS 6100, the correct test level must be performed in the setup shown below before the actual test.

1. Connect the amplifier output via the RF cable CHA 9580 to the transmitting antenna.
2. Move the receiving antenna to the 5 cm distance from the transmit antenna using the spacer.
3. Connect the receiving antenna with the BNC cable to the power meter channel 1 of NSG 4070C1/C2-LFCP.
4. Configure the test parameters in the software. Avoid damaging the power meters by calculating the expected levels beforehand. Use attenuators if necessary. Use the valid correction factors for the receiving antenna.
5. Perform the test level setting procedure save the result.

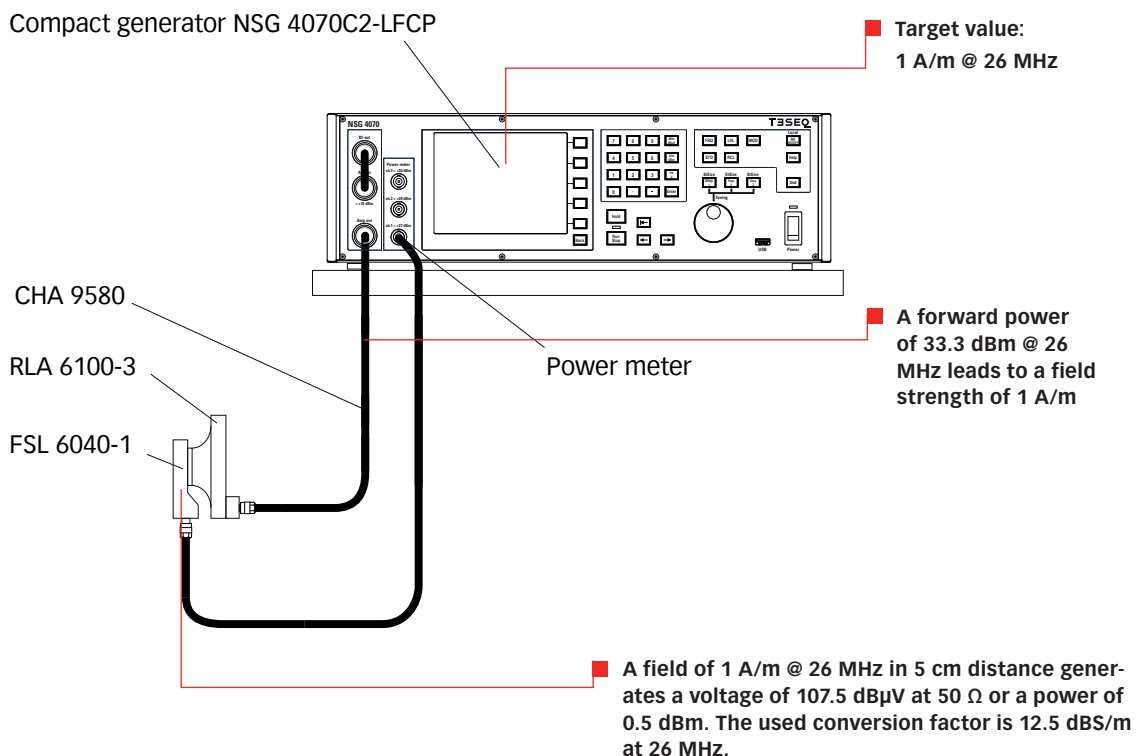

Figure 11: Set up example for test level setting for the whole frequency range

8.2.2. Test level setting for the frequency 13.56 MHz with ANP 4039

For the operation of the Loop Antenna Set LAS 6100, the correct test level must be performed in the setup shown below before the actual test.

1. Connect the amplifier output via the RF cable CHA 9580 and N-BNC adaptor to the ANP 4039 input.
2. Connect the ANP 4039 with the special cable LE 271 to the transmitting antenna RAL 6100-3. The connection between ANP 4039 and RAL 6100-3 cannot be extended. Extending the INA 271 cable changes the matching and reduces the effect of the ANP 4039.
3. Move the receiving antenna to the 5 cm distance from the transmit antenna using the spacer.
4. Connect the receiving antenna with the BNC cable to the power meter channel 1 of NSG 4070C1/C2-LFCP.
5. Configure the test parameters in the software. Avoid damaging the power meters by calculating the expected levels beforehand. Use attenuators if necessary. Use the valid correction factors for the receiving antenna.
6. Perform the test level setting procedure save the result.

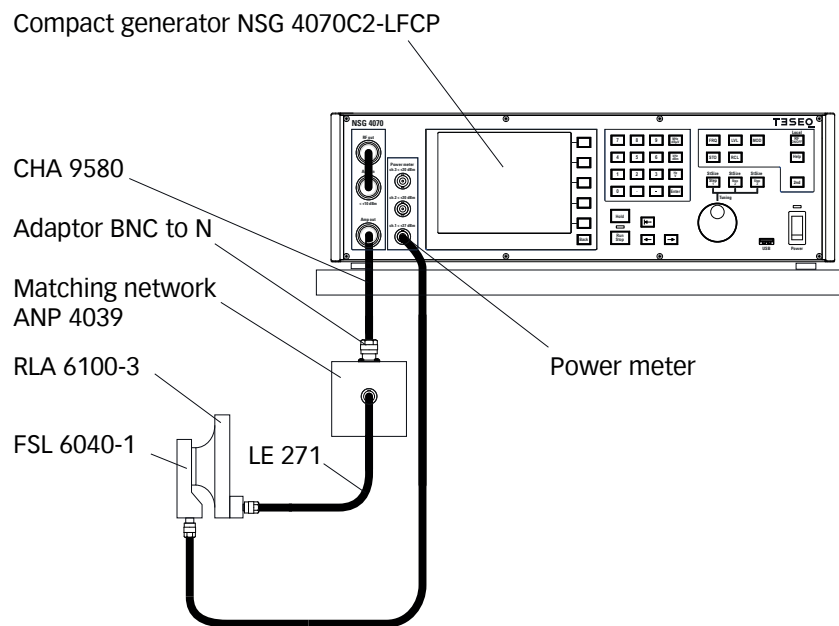

Figure 12: Set up example for test level setting for the frequency 13.56 MHz with ANP 4039

8.2.3. Testing for the whole frequency range

For the operation of the Loop Antenna Set LAS 6100, the test level setting procedure must have been performed beforehand.

1. Connect the amplifier output via the RF cable CHA 9580 to the transmitting antenna.
2. Remove the receiving antenna and place the radiation area panel at a distance of 5 cm from the transmitting antenna using the spacer.
3. Recall the test parameters and calibration result in the software.
4. Perform the test.

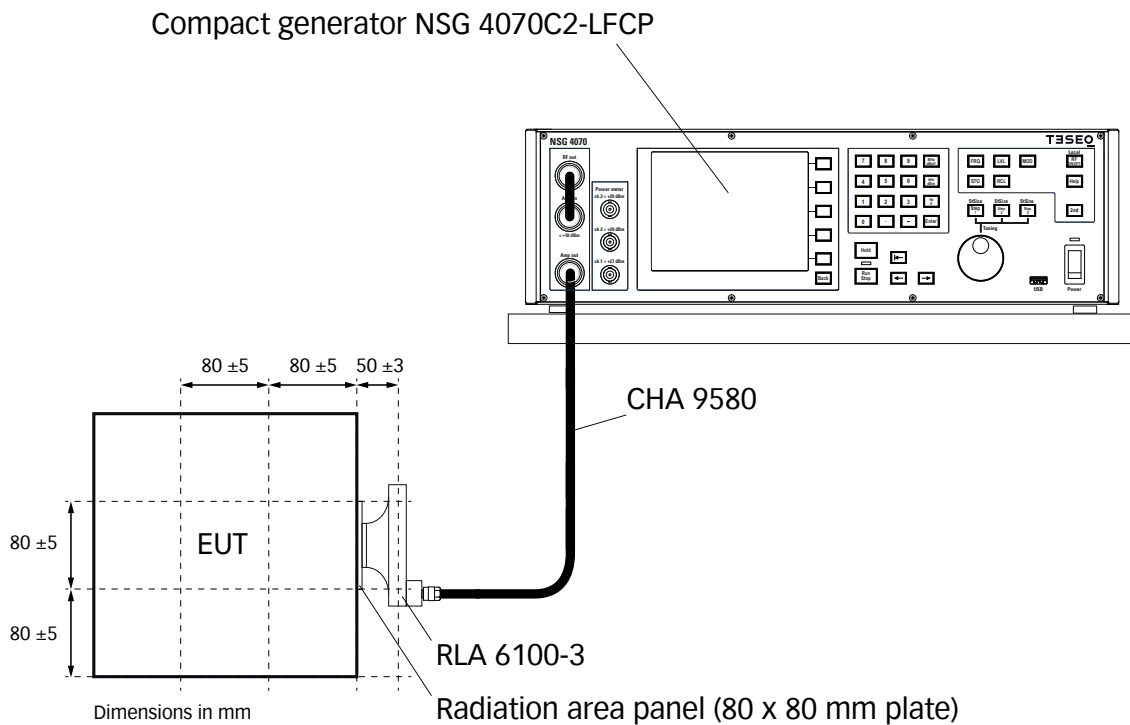

Figure 13: Set up example for testing

8.2.4. Testing for the frequency 13.56 MHz with ANP 4039

For the operation of the Loop Antenna Set LAS 6100, the test level setting procedure must have been performed beforehand.

1. Connect the amplifier output via the RF cable CHA 9580 and N-BNC adaptor to the ANP 4039 input.
2. Connect the ANP 4039 with the special cable LE 271 to the transmitting antenna RAL 6100-3.
The connection between ANP 4039 and RAL 6100-3 cannot be extended. Extending the INA 271 cable changes the matching and reduces the effect of the ANP 4039.
3. Remove the receiving antenna and place the radiation area panel at a distance of 5 cm from the transmitting antenna using the spacer.
4. Recall the test parameters and calibration result in the software.
5. Perform the test.

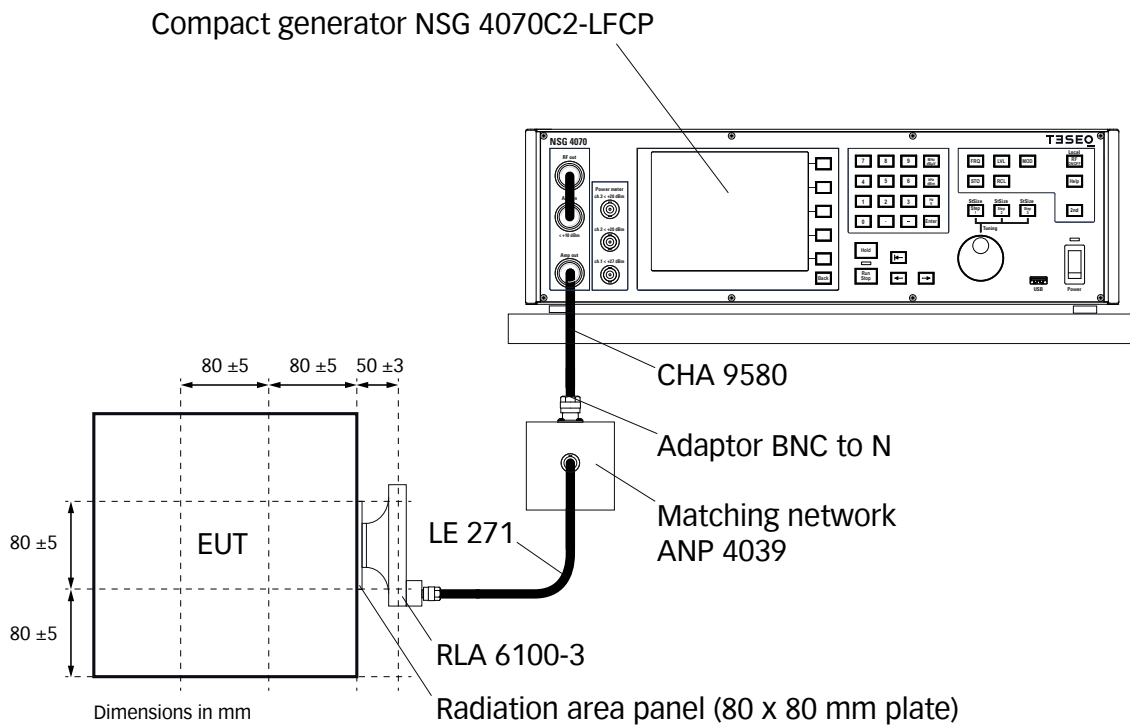

Figure 14: Set up example for testing the frequency 13.56 MHz with ANP 4039

8.2.5. Influence of the distance on the magnetic field strength

The following table shows the influence of the distance on the magnetic field strength. From this, conclusions can be drawn about the measurement uncertainty. Furthermore, the table helps to estimate the danger on the human body, e.g. when the antenna is held in the hand. For example, the Federal Office for Radiation Protection in Germany limits (26.BIMSCHV) a magnetic flux density of 27 μT above 3 kHz. Based on the example shown below, the user's hand would have to be at least 3 cm away from the antenna.



Avoid staying in the immediate vicinity of the antenna at field strengths above permissible values for the human body. For hand-held positioning, increase the distance to the antenna by suitable means (Use of the TPF 6100 tripod holder and, if necessary, extension with e.g. a wooden rod.). Note the dependencies in the table shown below.

Current in A	Distance in m	Field strength in A/m	Field strength in dB $\mu\text{A}/\text{m}$	Magnetic flux density in μT
1	0	30.00	149.54	37.50
1	0.01	28.29	149.03	35.36
1	0.02	24.01	147.61	30.02
1	0.03	18.92	145.54	23.64
1	0.04	14.28	143.10	17.86
1	0.05	10.61	140.51	13.26
1	0.06	7.87	137.92	9.84
1	0.07	5.89	135.40	7.36
1	0.08	4.47	133.00	5.58
1	0.09	3.44	130.72	4.30
1	0.1	2.68	128.57	3.35
1	0.11	2.13	126.55	2.66
1	0.12	1.71	124.64	2.13
1	0.13	1.39	122.85	1.73
1	0.14	1.14	121.15	1.43
1	0.15	0.95	119.54	1.19
1	0.16	0.80	118.02	1.00
1	0.17	0.67	116.57	0.84
1	0.18	0.58	115.20	0.72
1	0.19	0.49	113.88	0.62
1	0.2	0.43	112.63	0.54
1	0.21	0.37	111.43	0.47
1	0.22	0.33	110.28	0.41
1	0.23	0.29	109.18	0.36
1	0.24	0.25	108.11	0.32
1	0.25	0.23	107.09	0.28

The calculation is valid for RLA 6100 (100 mm loop antenna with 3 turns).

Table 11: Calculated field strength deviation in relation to the distance

8.2.6. Test levels

The following tables show the typical expected correlations for selected test levels.

Frequency in MHz	Field strength in A/m	Correction factor FSL 6040-1 in dBS/m	FSL 6040-1 on power meter in dB μ V	FSL 6040-1 on power meter in dBm	Forward power in dBm @ 0.1 A/m	Forward power in W @ 0.1 A/m
0.1	0.1	60.1	39.9	-67.1	-2.7	0.001
0.2	0.1	54.1	45.9	-61.1	-0.5	0.001
0.3	0.1	50.6	49.4	-57.6	0.1	0.001
0.4	0.1	48.1	51.9	-55.1	0.4	0.001
0.5	0.1	46.1	53.9	-53.1	0.5	0.001
0.6	0.1	44.5	55.5	-51.5	0.6	0.001
0.7	0.1	43.2	56.8	-50.2	0.6	0.001
0.8	0.1	42.0	58.0	-49.0	0.7	0.001
0.9	0.1	41.0	59.0	-48.0	0.7	0.001
1	0.1	40.1	59.9	-47.1	0.8	0.001
2	0.1	34.1	65.9	-41.1	1.1	0.001
3	0.1	30.6	69.4	-37.6	1.8	0.002
4	0.1	28.1	71.9	-35.1	2.5	0.002
5	0.1	26.2	73.8	-33.2	4.5	0.003
6	0.1	24.6	75.4	-31.6	4.4	0.003
7	0.1	23.3	76.7	-30.3	5.1	0.003
8	0.1	22.1	77.9	-29.1	5.8	0.004
9	0.1	21.1	78.9	-28.1	6.5	0.004
10	0.1	20.2	79.8	-27.2	7.1	0.01
11	0.1	19.4	80.6	-26.4	7.7	0.01
12	0.1	18.7	81.3	-25.7	8.3	0.01
13	0.1	18.0	82.0	-25.0	8.8	0.01
14	0.1	17.4	82.6	-24.4	9.2	0.01
15	0.1	16.8	83.2	-23.8	9.7	0.01
16	0.1	16.3	83.7	-23.3	10.0	0.01
17	0.1	15.8	84.2	-22.8	10.4	0.01
18	0.1	15.3	84.7	-22.3	10.7	0.01
19	0.1	14.9	85.1	-21.9	11.1	0.01
20	0.1	14.5	85.5	-21.5	11.5	0.01
21	0.1	14.1	85.9	-21.1	11.7	0.01
22	0.1	13.8	86.2	-20.8	12.1	0.02
23	0.1	13.4	86.6	-20.4	12.4	0.02
24	0.1	13.1	86.9	-20.1	12.7	0.02
25	0.1	12.8	87.2	-19.8	13.0	0.02
26	0.1	12.5	87.5	-19.5	13.4	0.02

Table 12: Expected correlations for test level 0.1 A/m

Frequency in MHz	Field strength in A/m	Correction factor FSL 6040-1 in dBS/m	FSL 6040-1 on power meter in dB μ V	FSL 6040-1 on power meter in dBm	Forward power in dBm @ 0.3 A/m	Forward power in W @ 0.3 A/m
0.1	0.3	60.1	49.4	-57.6	6.8	0.00
0.2	0.3	54.1	55.5	-51.5	9.1	0.01
0.3	0.3	50.6	59.0	-48.0	9.6	0.01
0.4	0.3	48.1	61.5	-45.5	9.9	0.01
0.5	0.3	46.1	63.4	-43.6	10.1	0.01
0.6	0.3	44.5	65.0	-42.0	10.1	0.01
0.7	0.3	43.2	66.3	-40.7	10.2	0.01
0.8	0.3	42.0	67.5	-39.5	10.2	0.01
0.9	0.3	41.0	68.5	-38.5	10.2	0.01
1	0.3	40.1	69.4	-37.6	10.3	0.01
2	0.3	34.1	75.5	-31.5	10.6	0.01
3	0.3	30.6	79.0	-28.0	11.4	0.01
4	0.3	28.1	81.5	-25.5	12.1	0.02
5	0.3	26.2	83.4	-23.6	14.1	0.03
6	0.3	24.6	85.0	-22.0	14.0	0.02
7	0.3	23.3	86.3	-20.7	14.7	0.03
8	0.3	22.1	87.4	-19.6	15.4	0.03
9	0.3	21.1	88.4	-18.6	16.1	0.04
10	0.3	20.2	89.3	-17.7	16.7	0.05
11	0.3	19.4	90.1	-16.9	17.2	0.05
12	0.3	18.7	90.9	-16.1	17.8	0.06
13	0.3	18.0	91.5	-15.5	18.3	0.07
14	0.3	17.4	92.1	-14.9	18.8	0.08
15	0.3	16.8	92.7	-14.3	19.2	0.08
16	0.3	16.3	93.2	-13.8	19.6	0.09
17	0.3	15.8	93.7	-13.3	19.9	0.10
18	0.3	15.3	94.2	-12.8	20.3	0.11
19	0.3	14.9	94.6	-12.4	20.6	0.12
20	0.3	14.5	95.0	-12.0	21.0	0.13
21	0.3	14.1	95.4	-11.6	21.3	0.13
22	0.3	13.8	95.8	-11.2	21.6	0.14
23	0.3	13.4	96.1	-10.9	21.9	0.16
24	0.3	13.1	96.4	-10.6	22.3	0.17
25	0.3	12.8	96.7	-10.3	22.5	0.18
26	0.3	12.5	97.0	-10.0	22.9	0.20

Table 13: Expected correlations for test level 0.3 A/m

Frequency in MHz	Field strength in A/m	Correction factor FSL 6040-1 in dBS/m	FSL 6040-1 on power meter in dB μ V	FSL 6040-1 on power meter in dBm	Forward power in dBm @ 1 A/m	Forward power in W @ 1 A/m
0.1	1	60.1	59.9	-47.1	17.3	0.05
0.2	1	54.1	65.9	-41.1	19.5	0.09
0.3	1	50.6	69.4	-37.6	20.1	0.10
0.4	1	48.1	71.9	-35.1	20.4	0.11
0.5	1	46.1	73.9	-33.1	20.5	0.11
0.6	1	44.5	75.5	-31.5	20.6	0.11
0.7	1	43.2	76.8	-30.2	20.6	0.12
0.8	1	42.0	78.0	-29.0	20.7	0.12
0.9	1	41.0	79.0	-28.0	20.7	0.12
1	1	40.1	79.9	-27.1	20.8	0.12
2	1	34.1	85.9	-21.1	21.1	0.13
3	1	30.6	89.4	-17.6	21.8	0.15
4	1	28.1	91.9	-15.1	22.5	0.18
5	1	26.2	93.8	-13.2	24.5	0.29
6	1	24.6	95.4	-11.6	24.4	0.28
7	1	23.3	96.7	-10.3	25.1	0.32
8	1	22.1	97.9	-9.1	25.8	0.38
9	1	21.1	98.9	-8.1	26.5	0.45
10	1	20.2	99.8	-7.2	27.1	0.52
11	1	19.4	100.6	-6.4	27.7	0.59
12	1	18.7	101.3	-5.7	28.3	0.67
13	1	18.0	102.0	-5.0	28.8	0.76
14	1	17.4	102.6	-4.4	29.2	0.84
15	1	16.8	103.2	-3.8	29.7	0.92
16	1	16.3	103.7	-3.3	30.0	1.00
17	1	15.8	104.2	-2.8	30.4	1.09
18	1	15.3	104.7	-2.3	30.7	1.18
19	1	14.9	105.1	-1.9	31.1	1.28
20	1	14.5	105.5	-1.5	31.5	1.40
21	1	14.1	105.9	-1.1	31.7	1.49
22	1	13.8	106.2	-0.8	32.1	1.61
23	1	13.4	106.6	-0.4	32.4	1.73
24	1	13.1	106.9	-0.1	32.7	1.87
25	1	12.8	107.2	0.2	33.0	2.00
26	1	12.5	107.5	0.5	33.4	2.17

Table 14: Expected correlations for test level 1 A/m

Frequency in MHz	Field strength in A/m	Correction factor FSL 6040-1 in dBS/m	FSL 6040-1 on power meter in dB μ V	FSL 6040-1 on power meter in dBm	Forward power in dBm @ 3 A/m	Forward power in W @ 3 A/m
0.1	3	60.1	69.4	-37.6	26.8	0.48
0.2	3	54.1	75.5	-31.5	29.1	0.81
0.3	3	50.6	79.0	-28.0	29.6	0.92
0.4	3	48.1	81.5	-25.5	29.9	0.98
0.5	3	46.1	83.4	-23.6	30.1	1.02
0.6	3	44.5	85.0	-22.0	30.1	1.03
0.7	3	43.2	86.3	-20.7	30.2	1.04
0.8	3	42.0	87.5	-19.5	30.2	1.05
0.9	3	41.0	88.5	-18.5	30.2	1.06
1	3	40.1	89.4	-17.6	30.3	1.07
2	3	34.1	95.5	-11.5	30.6	1.15
3	3	30.6	99.0	-8.0	31.4	1.38
4	3	28.1	101.5	-5.5	32.1	1.61
5	3	26.2	103.4	-3.6	34.1	2.57
6	3	24.6	105.0	-2.0	34.0	2.49
7	3	23.3	106.3	-0.7	34.7	2.92
8	3	22.1	107.4	0.4	35.4	3.45
9	3	21.1	108.4	1.4	36.1	4.03
10	3	20.2	109.3	2.3	36.7	4.65
11	3	19.4	110.1	3.1	37.2	5.29
12	3	18.7	110.9	3.9	37.8	6.03
13	3	18.0	111.5	4.5	38.3	6.80
14	3	17.4	112.1	5.1	38.8	7.52
15	3	16.8	112.7	5.7	39.2	8.31
16	3	16.3	113.2	6.2	39.6	9.02
17	3	15.8	113.7	6.7	39.9	9.82
18	3	15.3	114.2	7.2	40.3	10.63
19	3	14.9	114.6	7.6	40.6	11.50
20	3	14.5	115.0	8.0	41.0	12.60
21	3	14.1	115.4	8.4	41.3	13.41
22	3	13.8	115.8	8.8	41.6	14.46
23	3	13.4	116.1	9.1	41.9	15.55
24	3	13.1	116.4	9.4	42.3	16.81
25	3	12.8	116.7	9.7	42.5	17.99
26	3	12.5	117.0	10.0	42.9	19.57

Table 15: Expected correlations for test level 3 A/m

Frequency in MHz	Field strength in A/m	Correction factor FSL 6040-1 in dBS/m	FSL 6040-1 on power meter in dBµV	FSL 6040-1 on power meter in dBm	Forward power in dBm @ 7.5 A/m	Forward power in W @ 7.5 A/m
13.56	7.5	17.8	119.7	12.7	37.5	5.68

Table 16: Expected correlations for test level 7.5 A/m with connected ANP 4039

8.2.7. Power requirements

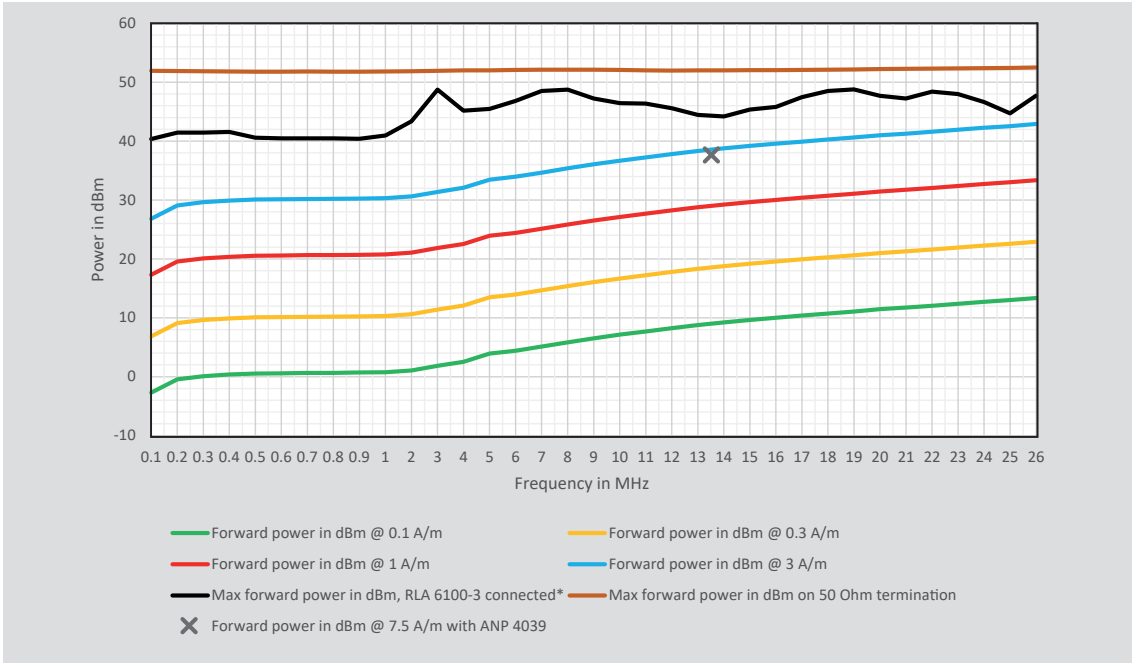

* The display of the forward power via a 50 Ohm power meter at the directional coupler is distorted by the strong mismatch. It can therefore only be used to a limited extent. Likewise, the output power of an amplifier is dependent on the connected load.

Figure 15: Example for typical power requirements using NSG 4070C1/C2-LFCP

8.2.8. Pulse modulation

In the frequency range 150 kHz to 26 MHz are tests with pulse modulation required. The test level setting (system calibration) is made in CW and modulation is switched on to test the EUT. An example in the time domain is shown below.

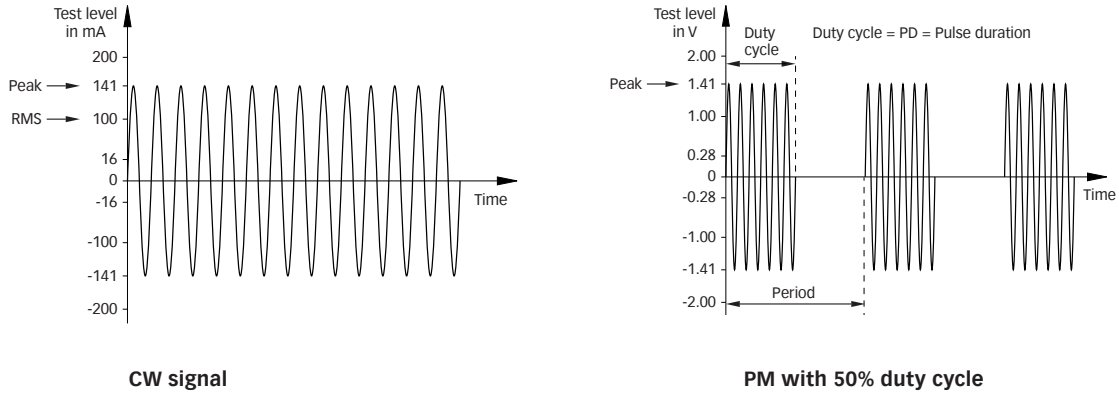

Figure 16: Pulse modulation

8.2.9. Power meter

Channel 1 is used for measuring the stress level (field strength) during the system calibration. The power meter channel 1 must be protected with an appropriate 50 Ω attenuator if the interference level plus the control tolerance reaches the power limit of 27 dBm.

8.2.10. Optically decoupled remote control

The converter USO 4013 allows the remote control of the NSG 4070 via a 20 m Polymeric Optical Fiber (POF). The USO 4013 connects the optical remote interface of the NSG 4070 with the USB interface of the control PC.

8.2.11. Test facility

The tests should be performed in a suitable, preferably shielded test environment. During calibration and testing, a sufficient distance (1 m) should be kept from metallic surfaces, apart from the DUT, etc. See also notes in IEC 61000-4-39.

9. TECHNICAL SPECIFICATIONS

9.1. Generator

RF	
Frequency range:	4 kHz to 1 GHz
Resolution:	1 Hz
Reference frequency:	10 MHz
Aging:	25 ppm
RF Level	
Level range:	-60 dBm to +10 dBm
Resolution:	0.1 dB
Settling time:	10 ms
Amplitude modulation	
Modulation depth:	0 to 100%
Modulation frequency range:	1 Hz to 50 kHz
Frequency resolution:	1 Hz
Pulse modulation (possible to interlace up to three pulse modulations)	
Rise/fall time (10%/90%):	< 1 μ s
Modulation frequency range:	0.01 Hz to 1 MHz
Frequency resolution:	0.01 Hz
Duty cycle:	0.1% to 100%
External modulation	
Delay time:	< 1 μ s / 180°
Period:	min. 20 μ s
Pulse width:	min. 10 μ s

9.2. Power meter

Frequency range:	4 kHz – 1 GHz
Linear measurement range	
channel 1:	-35 dBm to +27 dBm
channel 2,3:	-45 dBm to +20 dBm
Max. input/no damage	
channel 1-3:	+28 dBm
Noise level:	>5 dB below the measurement range
Input return loss:	>20 dB (below 500 MHz), >17 dB (500 MHz to 1 GHz)
Connector:	BNC socket, 50 Ω
Accuracy 10 to 30°C:	<0.5 dB, typ. <0.3 dB

9.3. Power amplifier

Nominal output power:	100 W
Frequency range:	9 kHz - 50 MHz
Type:	single band, class A
Input/output impedance (nominal):	50 Ω
Input return loss (minimum):	10 dB
Output return loss (nominal):	min. 9.5 dB
Output return loss without damage:	0 dB
Gain (minimum):	50 dB
Gain flatness (maximum):	+/- 3 dB
Linear output power (minimum)	
9 kHz to 30 MHz:	50 dBm (100 W)
30 MHz to 50 MHz:	49.5 dBm (90 W)
Input power without damage (maximum):	0 dBm
Harmonic distortion at linear output power (typical):	< -20 dBc

See also graphs in Chapter 8.1.5 and 8.2.7 for the connected LAS 6120 and LAS 6100.

Power amplifier of NSG 4070C1/C2-LFCP connected to 50 Ohms

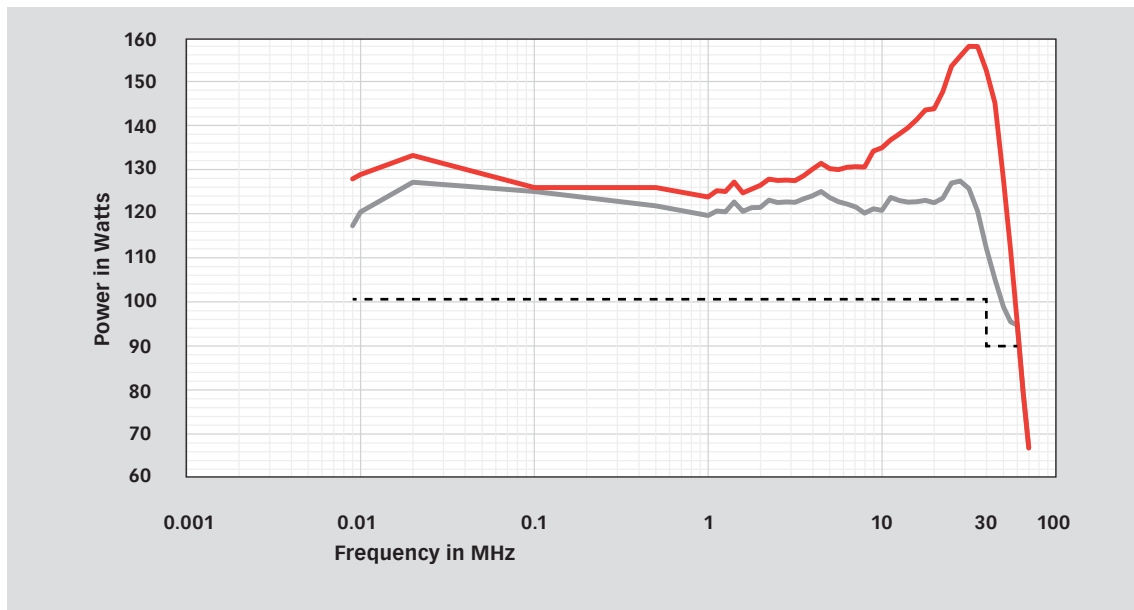

Legend:

- typical saturated power,
- typical linear power,
- - - - specification linear power

9.4. Test and measurement routines

9.4.1. Generator mode

Sweep:	frequency sweep, level sweep
Modulation:	AM, AM PC (peak conservation), pulse modulation and external
Others:	free parameter setting from 4 kHz to 1 GHz, high power mode using power amplifier

9.4.2. Power meter mode

Level setting:	free generator level setting via numeric input or rotary knob, generator ON/OFF, power amplifier (internal) ON/OFF
Frequency setting:	free frequency setting via numeric input or rotary knob
Power display:	channel 1 to 3, amplifier output (internal)

9.4.3. Immunity mode

Level:	Start and stop level or sections, levels in A/m
Loops:	LAS 6120 range 9 kHz to 150 kHz and LAS 6100 range 150 kHz to 26 MHz
Test methods:	according IEC 61000-4-39 range 9 kHz to 150 kHz and 150 kHz to 26 MHz
Sweep:	Frequency or section sweep with linear, steps per decade or percental increase
Modulation:	AM, AM PC (peak conservation), pulse modulation, external or mixed (e.g. 1 kHz AM internal modulated with 1 Hz PM external)
EUT monitoring:	Individual port configuration, EUT monitoring setup and check function, EUT monitoring results displayed during test in both results file and test report
Calibration:	System calibration and current probe calibration, display, calibration file store and recall function, recall of sensor loop correction files
EUT threshold search:	manual search by changing frequency or stress level
Store and recall:	function for test configurations, calibration results and test results, supports USB sticks
Component check:	quick system component check, e.g. cable, attenuator max. 58 dB insertion loss
Additional features:	free parameter setting from 4 kHz to 1 GHz, supports external power amplifier, directional coupler and attenuator (on power meter channel 1)

9.5. Analog ports

Front panel	
Generator output:	N socket 50 Ω , 4 kHz – 1 GHz
Power amplifier input:	N socket 50 Ω , max. 0 dBm
Power amplifier output:	N socket 50 Ω
Power meter channel 1 to 3:	as defined in chapter "Power meter"
Back panel	
Monitoring input analog:	BNC socket, 0-24 V $R_i=15$ k Ω , 6 mV resolution
External modulation input:	BNC socket, impedance >10 k Ω , level: 1 Vpp to get 100% AM, 1 Hz – 50 kHz
10 MHz reference output:	BNC socket, approx. 1 Vpp/50 Ω

9.6. Digital ports

Front panel	
USB:	USB host connector for USB stick, keyboard, mouse
Back panel	
User port:	D-Sub 15 pole 4 TTL inputs 4 TTL outputs +12 V / 800 mA, -12 V / 200 mA, +5 V / 800 mA power supply
Monitoring digital input:	BNC socket 0-24 V via optical coupler, $R_i=1.5$ k Ω , switching threshold approx. 2-3 V
Monitoring optical input:	LWL (Light wave connector), HP versatile link HFBR0501 series 40 kBd, (avoid scattered light on the back panel)
Trigger input:	BNC socket, TTL for external triggering, max. frequency 100 Hz, trigger delay <10 ms
RS232:	D-Sub 9 pole, up to 115200 Bd
RS232 optical:	Connector 2 x HFBRx523 socket for 1 mm fiber optic cable with length between 5 m and 30 m with 115200 Bd, for other distances 38400 Bd, max. 50 m
2x USB	USB host connector for USB stick, keyboard, mouse
USB device connector:	for remote control
Network:	RJ45, Ethernet 10/100 BASE-T

9.7. Power supply

Power consumption	100 to 240 VAC 50/60 Hz autoranging	Recommended fuse F1 for nominal 110 V	Recommended fuse F1 for nominal 230 V
NSG 4070C1/C2-LFCP	approx. 512 W	6.3 A (slow)	2.5 A (slow)

9.8. General data

Operating temperature range:	0°C to 40°C
Storage temperature range:	-20°C to 60°C
Relative humidity:	95%/30°C (no moisture condensation)
EMC:	DIN / EN 61326-1:2013
Shock:	DIN / EN 60068-2-27
Vibration:	DIN / EN 60068-2-6
Protection class:	DIN / EN 61010-1 / IEC 61010-1

9.9. Mechanical specifications

Size (W x H x D) :	45 cm (19") x 15 cm (3HU) x 42.3 cm (with handle bar and foot)
Weight:	approx. 15 kg (with internal power amplifier)
Cardboard box:	80 cm x 61 cm x 34 cm, approx. 8 kg (empty)



10. TROUBLESHOOTING





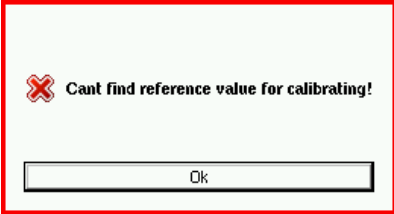
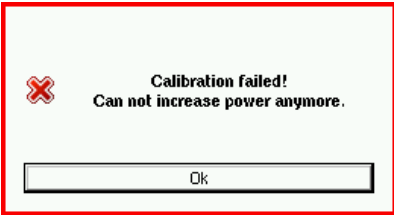

Re-check the unit before beginning troubleshooting

- Are all the connections correct?
- Are you following the instructions in the manual?
- Are the amplifier and connected accessories operating properly?

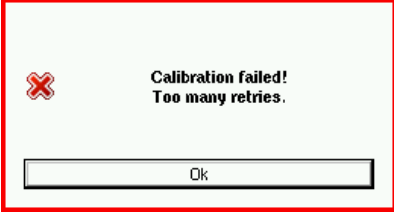
If the NSG 4070 does not seem to be functioning properly, check the table below. If this does not solve the problem, the NSG 4070 may be damaged. Turn off the power, unplug the power supply cord from the power outlet, and contact your nearest Teseq sales office.

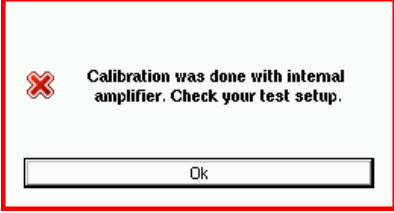
Symptom	Check	Chapter
Power does not turn on.	<ul style="list-style-type: none"> ■ Plug the power supply cord securely into the power outlet. ■ Check if standby LED is on (Orange). ■ Check if the outlet is supplied with power. ■ Check the fuse. 	3.2.1 3.2.2
	<p>Power meter is working below the measuring range.</p> <ul style="list-style-type: none"> ■ Increase the stress level. ■ Reduce the frequency range for calibrating a monitor probe. The insertion loss/amplification might be too high. 	4.5 4.6.3.3
	<p>Power amplifier limit is reached.</p> <ul style="list-style-type: none"> ■ Check your setup, power meter 1 might not be connected, insertion loss too high. ■ Check the ground connections of the coupling device ■ Decrease the stress level. 	4.5
	<p>Power meter ch.1 limit will be exceeded.</p> <ul style="list-style-type: none"> ■ There is not an attenuator or the used additional attenuator is not enough. Insert an additional attenuator in the path to the power meter channel 1 and put this value in the Setup -> Power Limits menu. ■ Decrease the stress level. 	4.3.3 4.5

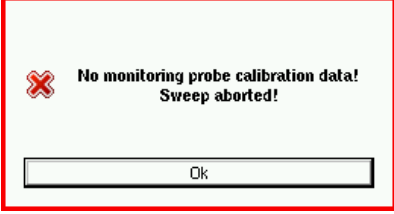
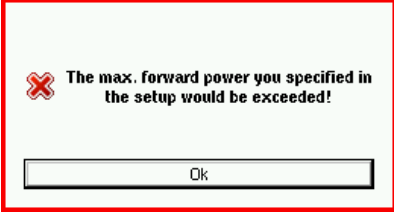
Symptom	Check	Chapter
	<p>Target level cannot be adjusted after 50 retries</p> <ul style="list-style-type: none"> ■ Check the coupling device (e.g. use the locking system to close the EM clamp or current injection probe correctly) ■ Check the connection to channel 2 if using external directional coupler 	
	<p>Power amplifier is saturated and not able to have the reserve needed for the modulation</p> <ul style="list-style-type: none"> ■ Check the connections of power meter ch. 2 if external amplifier / directional coupler is used. ■ Use the saturation check ■ Decrease the stress level. 	4.6.3.2 4.5
	<ul style="list-style-type: none"> ■ Use the same amplifier (internal/external) as used for the calibration. 	4.6.1.3
	<ul style="list-style-type: none"> ■ First recall calibration file or perform calibration, then start test. 	4.6.5
	<p>Tests using of the monitoring probe require recall of both the system calibration file <u>and</u> monitor probe calibration file.</p> <ul style="list-style-type: none"> ■ Recall system calibration file <u>and</u> monitor probe calibration file, then start test. 	4.6.5
	<ul style="list-style-type: none"> ■ Check the specified limitation of the max. forward power in the Setup -> Power Limits menu. ■ Check the connections ■ Decrease the stress level. 	4.3.3 4.5

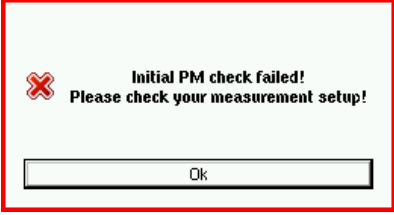
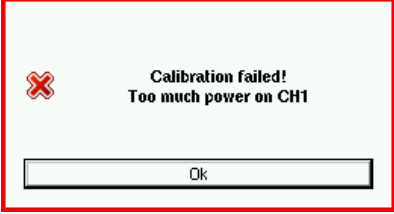
Symptom	Check	Chapter
	<ul style="list-style-type: none"> ■ Check the connection. ■ Insertion loss or amplification of the probe calibration setup is out of range. 	
	<p>Power meter ch.1 limit will be exceeded.</p> <ul style="list-style-type: none"> ■ Insert an additional attenuator in the path to the power meter channel 1 and put this value in the Setup -> hardware menu. ■ Decrease the stress level. 	<p>4.3.3</p> <p>4.5</p>
<p>Error adjusting test level!</p>	<p>Power meter for adjusting the forward power is in the noise or not connected.</p> <ul style="list-style-type: none"> ■ Establish the connection. ■ Increase the stress level. ■ Increase the start level of the threshold search. 	

10.1. Procedure to check the function of the power meters

The power meter inputs are very sensitive and can be damaged very easily. The following step-by-step description provides a simple test procedure. A damaged power meter channel shows clear visible differences to the generator level. Please avoid any direct connection of the amplifier output to the power meter inputs.

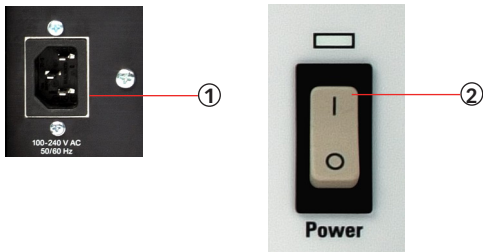
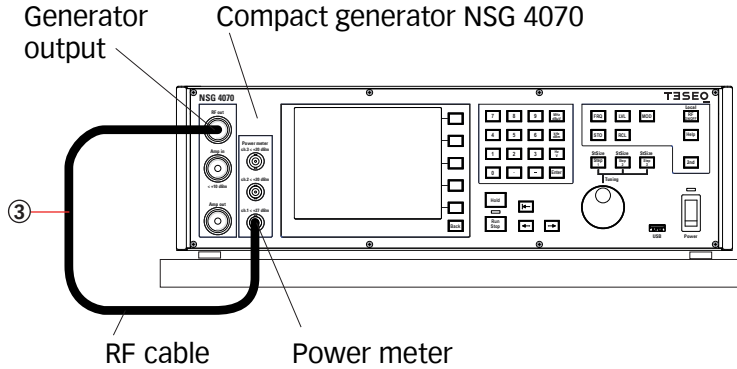

1. Connect the NSG 4070 with a suitable mains socket.
2. Switch the unit on.
3. Connect "RFout" (Generator output) with the power meter. (NSG 4070 with built-in power amplifier are supplied with a bridge between "RF out" and "Amp in". This bridge needs to be removed for this check procedure.) **Do not connect "Amp out" with the power meter!**
4. Press "POWERMETER". Related to the default settings will be used a frequency of 100 MHz and a generator level of -30 dBm. Modulation and RF are switched off.
5. Press "CH. 1".



6. Press the hardkey "RF ON/OFF".
7. The symbol shows the RF is switched on.

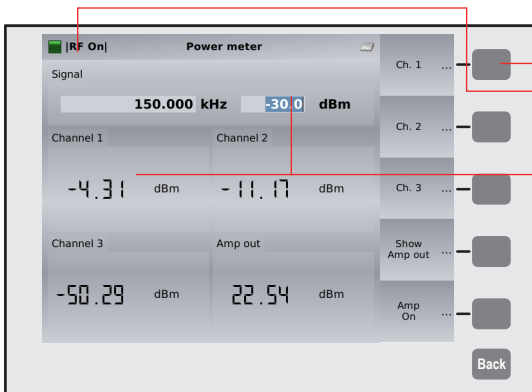

8. Compare the generator power level with power meter readings. The example shows a damaged power meter channel 1.
9. Change the setup and connect one of the other power meter input. Activate the power meter input by using the specific softkey. Compare the generator power level with power meter readings. Repeat this step with the last power meter.

11. MAINTENANCE

11.1. General

The NSG 4070 including the accessories need no special maintenance. Maintenance is limited to cleaning the contacts and air inlets and outlets. The life time of the connectors is limited because of the contact durability. Teseq can replace the worn out connectors.

No modifications are to be carried out on the NSG 4070 and accessories by the user.

11.2. Cleaning

The cleaning shall be done with dry cloth. If a wet cleaning would become necessary, make sure that no humidity will enter inside of the unit and clean the instrument housing with a damp cloth using a little mild, non-abrasive household cleanser if necessary.

Chemicals must not be used for cleaning purposes

12. DISPOSAL

The unit is constructed that it can be dismantled right down to the component level.

Manufacturer

AMETEK CTS Europe GmbH

12623 Berlin, Germany
Landsberger Str. 255
T +49 30 5659 8835
F +49 30 5659 8834
customercare.cts@ametek.com
www.ametek-cts.com

China

AMETEK Commercial Enterprise (Shanghai) Co., Ltd. Beijing Branch

T +8610 8526 2111
F +8610 8526 2141
sales.cts.cn@ametek.com

Japan

AMETEK Co., Ltd. Nagoya Office

T +81 52 709 5501
cts-japan.sales@ametek.com

Taiwan

AMETEK Taiwan Corp. Ltd

T +886 3 575 0099
taiwansales.cts@ametek.com

USA

AMETEK CTS US

T +1 732 417 0501
Toll free +1 888 417 0501
usasales.cts@ametek.com

Europe

AMETEK CTS Europe GmbH

T +49 2307 26070-0
sales.cts.eu@ametek.com

Singapore

AMETEK Singapore Pte Ltd

T +65 6484 2388
singaporesales.cts@ametek.com

To find your local partner within
Teseq's global network, please go to
www.ametek-cts.com



© June 2023 Teseq®
Specifications subject to change without notice.
All trademarks recognized.

AMETEK CTS Europe GmbH is an ISO-registered
company. Its products are designed and manufac-
tured under the strict quality requirement of the
ISO 9001.

This document has been carefully checked.
However, AMETEK CTS Europe GmbH does not
assume any liability for errors or inaccuracies.