

User Manual IMU4000

This User Manual is valid for all versions of IMU4000



Title:	EMC Test System IMU4000
Date:	10.07.2012
Product Manager:	M. Sacchi
Calibration Manager:	R. Henz
Technical Manager:	M. Lutz
Revised:	20.06.2014

EMC TESTER
IMU4000 and Versions

**Attention Standard References and User Manual**

This user manual provides information necessary for operation of the test equipment.

Throughout the users manual, standard references are used as an aid to understanding only.

The relevant standard(s) **must** be obtained and used in conjunction with this users manual

**Attention contact EMC PARTNER!**

Before starting any test, where specifications or limits for a particular application are not included or could not be found in the EMC PARTNER documentation (User Manual, Instruction Sheet), users must contact EMC PARTNER for clarification.

Repair costs arising from incorrect use or failure to clarify an application with EMC PARTNER remain the responsibility of the user.

**Achtung EMC PARTNER kontaktieren!**

Wenn für eine Anwendung die notwendigen Informationen: Parameter oder Limiten nicht aufgeführt sind in der Bedienungsanleitung UM oder in der Instruktiionsanweisung IS, ist der Anwender verpflichtet EMC PARTNER zu kontaktieren bevor die Prüfung gestartet wird. Anfallende Reparatur- und Kalibrationskosten bei nicht Beachtung der Limiten in Bedienungsanleitung / Instruktiionsanweisung oder unterlassen der Rückfrage werden den Kunde belastet.

**ATTENTION, veuillez contacter EMC PARTNER!**

Lorsque, pour une application, des limites ou des informations nécessaires ne sont pas mentionnées dans la documentation, l'utilisateur est tenu de prendre contact avec EMC PARTNER afin de recevoir les informations supplémentaires avant de commencer les tests.

Les coûts de réparation dus au non respect des limites figurant dans le mode d'emploi ou dans la notice d'utilisation ainsi que l'omission d'une demande de précision seront à la charge du client.



Declaration of Conformity

See sheets attached at the end of this user manual:

- Declaration of conformity to product standards
- Declaration of conformity to low voltage directive
- Declaration of conformity to EMC directive

Contents:

1	DESCRIPTION	9
1.1	The interference sources of the transients	9
1.1.1	Electrostatic discharge ESD	9
1.1.2	Switched inductance EFT (Burst)	9
1.1.3	Indirect lightning SURGE	10
1.1.4	Voltage interruptions, Dips	11
1.1.5	How ESD, EFT, SURGE DIPS differ	11
1.1.6	Common mode disturbances in the frequency range 0 Hz to 150 kHz	12
1.2	Overview of the IMU4000 test system	12
1.2.1	IMU4000	12
1.2.2	ESD - IMU4000 System overview	14
1.2.3	EFT - IMU4000 System overview	14
1.2.4	SURGE - IMU4000 System overview	15
1.2.5	DIPS and Interruption – IMU4000 System overview	15
1.2.6	Magnetic fields - IMU4000 System overview IEC 61000-4-8 Ed.2	16
1.2.7	Magnetic fields - IMU4000 System overview IEC 61000-4-9 Ed.1	16
1.3	Technical data of the IMU4000	17
1.3.1	Electrostatic discharges ESD only valid with EXT-TRA3000 E	17
1.3.2	Electric Fast Transient EFT EXT-IMU4000 F5	18
1.3.3	Coupling / De-coupling Network EFT	18
1.3.4	Lightning and switching actions SURGE (IEC 61000-4-5 Ed.3)	20
1.3.5	Coupling / De-coupling Network „CDN-SURGE“	20
1.3.6	Power voltage limits on direct output used together with external SURGE CDN	21
1.3.7	Voltage interruption and Variation with internal Variac EXT-TRA3000 D-V	21
1.3.8	Interruption and Voltage Variation IEC 61000-4-11 Ed.2 with external Variac	22
1.3.9	DIPS circuit in accordance with IEC 61000-4-29 for d.c. power ports.	22
1.3.10	Synchronisation of IMU4000 to mains frequencies	23
1.3.11	Measuring circuit, measuring outputs	23
1.3.12	Trigger Output Levels	24
1.3.13	Control	24
1.4	Mechanical dimensions	25
1.5	Power Consumption	25
1.6	Included articles, dimensions	25
1.7	Standard accessories	26
2	SAFETY	27
2.1	Safety standard	27
2.2	Climatic Conditions	27
2.3	Precautionary measure during use	28
2.4	Electromagnetic Compatibility	28

2.5	The manual is an integral part of the equipment. Refer to the manual.	28
2.6	Sécurité	29
2.6.1	Normes de sécurité	29
2.6.2	Conditions climatiques	29
2.6.3	Mesures de précaution lors de l'utilisation	30
2.6.4	Compatibilité électromagnétique	30
2.6.5	Le manuel fait partie intégrante de l'équipement.	30
2.7	Sicherheit	31
2.7.1	Sicherheit Standard	31
2.7.2	Klimatische Bedingungen	31
2.7.3	Vorsichtsmassnahmen während dem Betrieb	32
2.7.4	Elektromagnetische Verträglichkeit	32
2.7.5	Dieses Manual ist Bestandteil von IMU4000 und dessen Testumgebung.	32
3	MECHANICAL STRUCTURE	33
3.1	General	33
3.2	Impulse-forming Networks	34
3.3	Measuring Circuit	35
3.4	Coupling / De-coupling Network CDN	35
3.5	EUT power supply at DIPS	35
4	CONTROL PANEL	37
4.1	Front panel of the IMU4000	37
4.1.1	Control part	37
4.1.2	Operation panel	39
4.2	Rear Panel of the IMU4000	41
5	PREPARATION FOR OPERATION	45
5.1	Attention, Refer to Manual	45
5.2	Operators and Service Personnel	45
5.3	Checks before operation	45
5.3.1	Optical verification of the IMU4000 Generators	45
5.3.2	Power source check	45
5.3.3	Connecting the IMU4000 Generator to the power line	45
5.3.4	EUT Power, Power source for the EUT	45
5.3.5	EUT Power with voltages different from the public power line (Variac)	47
5.4	EUT Power, supply of the EUT with dc	48
5.4.1	SURGE superimposing on dc	49
5.5	Hints for the test set up according to IEC standards	50

5.5.1	Test set up EFT	50
5.5.2	ESD test set up	51
5.5.3	Test set up SURGE	52
5.5.4	Test set-up for table top equipment	54
5.6	Practical testing sequence	55
6	TESTING WITH THE IMU4000	57
6.1	Operation of the tester via touch screen monitor	57
6.1.1	General information about the touch screen monitor	57
6.1.2	Selecting the parameter – Example CWG	57
6.2	The general menu	61
6.2.1	General menu “Setups”	61
6.2.2	General menu “Setup Linker”	61
6.2.3	General menu “Protocols”	61
6.2.4	General menu “Settings”	62
6.2.5	General menu “System”	63
6.2.6	General menu “Power”	63
6.2.7	EUT - Power and EUT - Control	63
6.2.8	General menu “Update”	64
6.3	EMC test operation „RUN Mode“	64
6.3.1	Example CWG operation	65
6.3.2	Web Server	65
7	MAINTENANCE AND SERVICING	67
7.1	Maintenance	67
7.2	Cleaning front and rearplate	67
7.3	Verification versus Calibration	67
7.3.1	Verification Example IEC 61000-4-4 Ed.2	67
7.3.2	Calibration Example IEC 61000-4-4 Ed.2	67
7.4	Verification of the IMU4000 by the user	67
7.4.1	EFT	67
7.4.2	ESD	68
7.4.3	SURGE	68
7.4.4	Interruption	68
7.4.5	Variation	68
7.5	Calibration of the IMU4000 by EMC PARTNER AG	69
7.6	Service of SPD Surge Protective device	69
8	WHAT MUST BE DONE FOLLOWING FAILED OPERATION	71
8.1	Service; Repairs	71
8.1.1	Service Flowchart of IMU4000 System:	72
8.1.2	Data Transfer via UBS Stick	72

8.2	Spare parts list	72
8.3	Check before you contact the service of EMCP	73
8.3.1	Fuses	73
8.4	Service department of EMC PARTNER AG	73
9	PACKAGING AND TRANSPORT	75
9.1	Packaging	75
9.2	Transport	75
10	RECYCLING / DISPOSAL	77
10.1	RoHS directive 2002/95/EG	77
10.2	WEEE directive 2002/96/EG	77
10.3	Information for dismantling	77
10.4	Parts which can be recycled	77
10.5	Parts which cannot be recycled	77
11	ACCESSORIES	79
11.1	TRA accessories to IMU4000 Versions	79
11.2	Use of TRANSIENT accessories	81
12	REMOTE PORTS	83
12.1	General	83
12.1.1	Ethernet port setting on IMU4000	83
12.1.2	IP address setting on PC	83
12.1.3	Using Web Browser	84
12.2	Software "TEMA3000" for IMU4000	84
12.2.1	TEMA3000 Basic	84
13	APPENDIX AND CORRECTIONS	87
13.1	Appendix	87
13.1.1	Definition of the EFT Waveform	87
13.1.2	Definition of the ESD Waveform	88
13.1.3	Definition of the SURGE Waveform	89
13.1.4	DIPS Specification	90
13.1.5	VARIATION Specification IEC 61000-4-11 Ed.1	91
13.1.6	VARIATION Specification IEC 61000-4-11 Ed.2	92
13.2	Correction	93

13.2.1	Declaration of conformity to the EMC directive 2004/108/EC	93
13.2.2	Declaration of conformity to the LV directive 2006/95/EC	93
13.2.3	Declaration of conformity to the Basic Standards	93
14	GLOSSARY	95
15	INDEX	97

1 Description

1.1 The interference sources of the transients

1.1.1 Electrostatic discharge ESD

Electro Static Discharge IEC 61000-4-2 Ed2

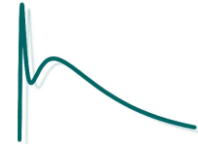

What causes electrostatic discharges?

A person becomes electrostatically charged by walking over an insulating floor surface. The capacity of the body can be charged to several kilovolts (1000 V). This capacity is discharged when contact is made with an electronic unit or system. The discharge is visible as a spark in many cases and can be felt by person concerned, who gets a „shock“. The discharges are harmless to humans, but not to sensitive, modern electronic equipment. The resulting current causes interference in the units or can make entire systems „crash“.

For over 25 years it has been known to the electrical industry that electrostatic discharges as encountered every day can have a disastrous effect on electronic equipment.

The cost of damage caused by ESD is difficult to assess, but amounts to billions of dollars worldwide.

The areas most affected are:

- manufacturing of integrated circuits (chips).
- the chemical industry, e.g. by explosion, fires caused by the sparks from electrostatic discharges.
- malfunctioning of process control with the secondary damage costs.

1.1.2 Switched inductance EFT (Burst)

Electric Fast Transient or Burst. IEC 61000-4-4 Ed.3

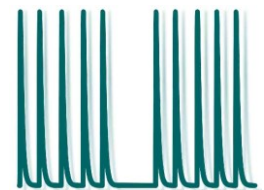

Industrial measurement and control equipment practically always operates in conjunction with conventional control units (relays, contactors). Fluorescent lamp ballast units, insufficiently suppressed coffee grinders, vacuum cleaners, drilling machines, hair dryers, universal motors, etc. can be found everywhere in the power supply system. All these, primarily inductive loads, produce interference when switched on and off. A wide range of switching transients, also called bursts, are produced with the following waveform.

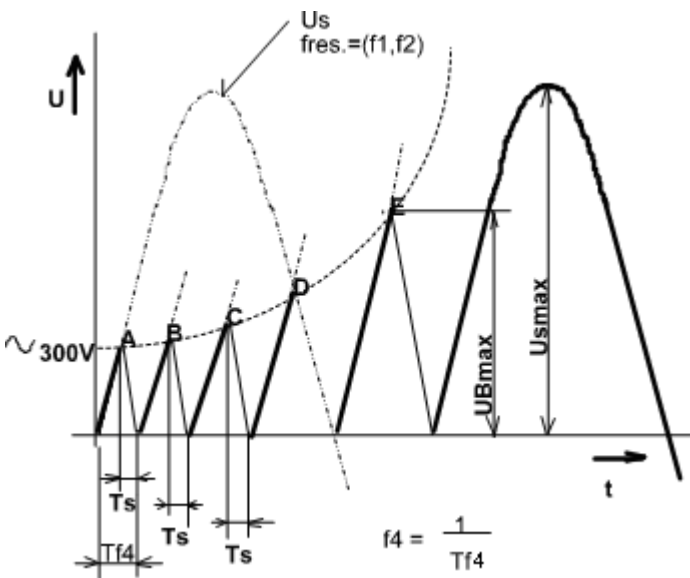

Figure: 1.0.1.2

The parameters which define the burst are:

- Rise time of the spike T_s in ns
- Repetition frequency f_4 in the range of kHz up to MHz
- Energy, some mJ
- Voltage amplitude U_{Bmax} . up to some kV
- Duration of a burst several milliseconds

The different EFT sources generate different burst waveforms. A typical burst waveform is shown in the figure above.

The impedance of the EFT source is generally high, therefore the capacitance of connected cables influences the rise time.

1.1.3 Indirect lightning SURGE

SURGE are transients with a high energy, relatively low frequency content up to some kV.

[IEC 61000-4-5 Ed.3](#)

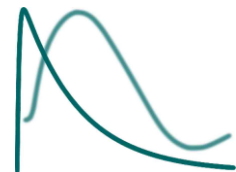

Lightning is a daily event and occurs about 8 million times in approximately 44,000 storm centres throughout the world. That is in the order of 100 discharges per second. Measuring and recording equipment in aircraft registers one lightning strike for every 1,000 flying hours.

Product assembly and finishing in many industries depends on modern electronics. The most frequent cause of damage is overvoltage, caused either by switching action in the equipment itself or by atmospheric discharges such as lightning. In order that the overvoltages do not destroy the electronic equipment, protection elements and circuits are placed at the inputs and outputs of electronic equipment.

Consumer electronic devices, such as antenna ports on television sets, telephones, faxes, can also be influenced by atmospheric discharges. The disturbances are mostly tolerable because of their relatively low occurrence. To protect such equipment from damage protection elements and circuits are installed. Tests must be carried out to determine whether these protective circuits are really effective.

Besides lightning, switching action can also generate high energy impulses.

1.1.4 Voltage interruptions, Dips

DIPS means a sudden reduction of the voltage at a point in the electrical system, followed by voltage recovery after a short period of time from a few cycles to a few seconds.

IEC 61000-4-11 Ed.2





Voltage failures occur following switching operations, short-circuits, fuses blowing and when running up heavy loads. These are man-made faults, produced unintentionally, and include operation of domestic appliances, electronically controlled machine tools, switching operations in the public lighting system, economy lamps, etc.

The quality of the electrical power supply is increasingly becoming a central topic of discussion. Interference sources in the mains, caused by electronic power control using non-linear components such as thyristors are increasing. These devices are used in domestic appliances, such as hotplates, heating units, washing machines, television sets, economy lamps, PCs and industrial systems with speed-controlled drives. Simultaneously an increase in electronic systems sensitive to interference is apparent in all sectors of the electrical power system.

In order to achieve electromagnetic compatibility, both the interaction of the electrical equipment connected to the supply and its noise immunity must be determined.

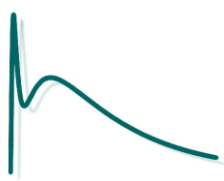
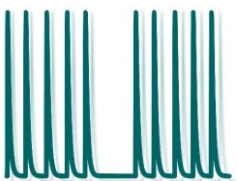
1.1.5 How ESD, EFT, SURGE DIPS differ

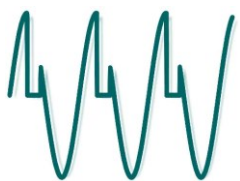
Characteristics	Static discharges	Switched inductance	Lightning. switching actions	Mains Interruptions
Phenomenon	"ESD"	"EFT Burst"	"Surge"	"DIPS"
Voltage U	up to 15 kV	up to 4 kV	up to 4 kV	supply source voltage
Energy at maximum voltage	approx. 10 mJ	300 mJ	300 J	-
Repetition rate	Single event	Multiple event 5 kHz	Maximum 6 Impulse / minutes	supply source frequency
Application to the different ports	Touchable metallic part (enclosure ports)	AC/DC ports, Signal and data lines	AC/DC ports, Signal and data lines	AC/DC ports
upper limit frequency	approx.. 1 GHz	approx. 200 MHz	approx. 350 kHz	approx. 100 kHz
impulse waveform	 IEC 61000-4-2 Ed.2	 IEC 61000-4-4 Ed.2	 IEC 61000-4-5 Ed.2	 IEC 61000-4-11 Ed.2

The overview of „How ESD,EFT, SURGE,DIPS differ“ shows that all four test have to be carried out because the frequency content and energy of the four transient tests are different.

1.1.6 Common mode disturbances in the frequency range 0 Hz to 150 kHz

IEC 61000-4-16 Ed.1 Amd.2

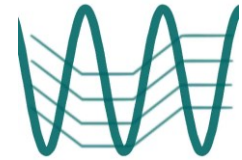

The conducted, common mode disturbances at mains frequency and its harmonics may be generated by faults on the mains power distribution system and leakage currents flowing into the earth system. The d.c. power supply network used in industrial, electrical plants and telecommunication centres may also generate d.c. common mode disturbances, particularly when either the positive or negative terminal is connected to earth.

Electrified railways will also generate disturbances at their frequency of operation (typically $16\frac{2}{3}$ Hz).

The induced disturbances are described in detail in IEC 61000-2-3 and IEC 61000-2-5. The different types of disturbances may be present simultaneously but at different levels.

Furthermore, if the power system develops a fault, the disturbance levels may be up to 10 times the reference levels given for normal operating conditions, however the fault condition disturbances are typically present for short durations only (up to about 1 s).

The disturbances at mains frequency and harmonics may affect signal ports of equipment where insufficient common mode rejection is available. Disturbances up to 1-2 kHz are mainly due to the harmonics of the power mains.

At higher frequencies the disturbances are mostly related to power electronic equipment, which may produce switching currents involving the ground system, giving rise to conducted, common mode disturbances.

1.2 Overview of the IMU4000 test system

1.2.1 IMU4000

The tester IMU4000 simulates transients of different interference sources. Such as: indirect lightning in electronic systems, human body electrostatic discharges, switched inductance (Burst), power supply interruptions and variations and common mode disturbance.

The test system IMU4000 with accessories fulfils all requirements of the IEC basic standards 61000-4-2 Ed.2 (ESD); 61000-4-4 Ed.3 (EFT); 61000-4-5 Ed.3 (SURGE); impulse; 61000-4-11 Ed.2 (Interruption and Variations), and with accessories 61000-4-8 Ed.2 (Magnetic field 50/60Hz) and 61000-4-9 Ed.1 (Magnetic field SURGE), 61000-4-29 Ed.1 dips and interruption on d.c. and IEC 61000-4-34, DIPS and Interruption >16A per phase.

If not all transient test are needed, the IMU4000 tester is also available in various versions, with the possibility to upgrade the tester later to a full IMU4000 test system.

1.2.1.1 The following IMU4000 version are available:

Prduct Nr.	Type
106753	IMU4000 F
106756	IMU4000 S
106757	IMU4000 D
106758	IMU4000 C
106759	IMU4000 F-S
106760	IMU4000 D-V
106761	IMU4000 F-V
106762	IMU4000 S-V
106763	IMU4000 F-D-V
106764	IMU4000 S-D-V
106765	IMU4000 D-V-C
106766	IMU4000 F-S-C
106767	IMU4000 F-S-D-V
106768	IMU4000 S-D-V-C
106769	IMU4000 F-S-D-V-C
106770	IMU4000 F-C
106771	IMU4000 F-S-D
106772	IMU4000 S-C
106774	IMU4000 D-C
106775	IMU4000 V
106776	IMU4000 F-S-D-C
106777	IMU4000 F5
106778	IMU4000 F5-S
106779	IMU4000 F5-S-D-V
106780	IMU4000 F5-V
106781	IMU4000 F5-C
106782	IMU4000 F5-S-D
106783	IMU4000 F5-D-V
106784	IMU4000 F5-S-C
106785	IMU4000 F5-S-D-C
106786	IMU4000 F5-S-D-V-C
106896	EXT-IMU4000 F
106897	EXT-IMU4000 S
106898	EXT-IMU4000 F5

1.2.2 ESD - IMU4000 System overview

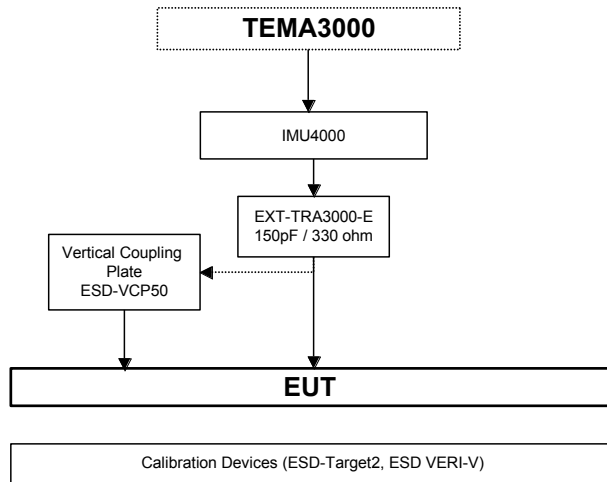

1.2.3 EFT - IMU4000 System overview

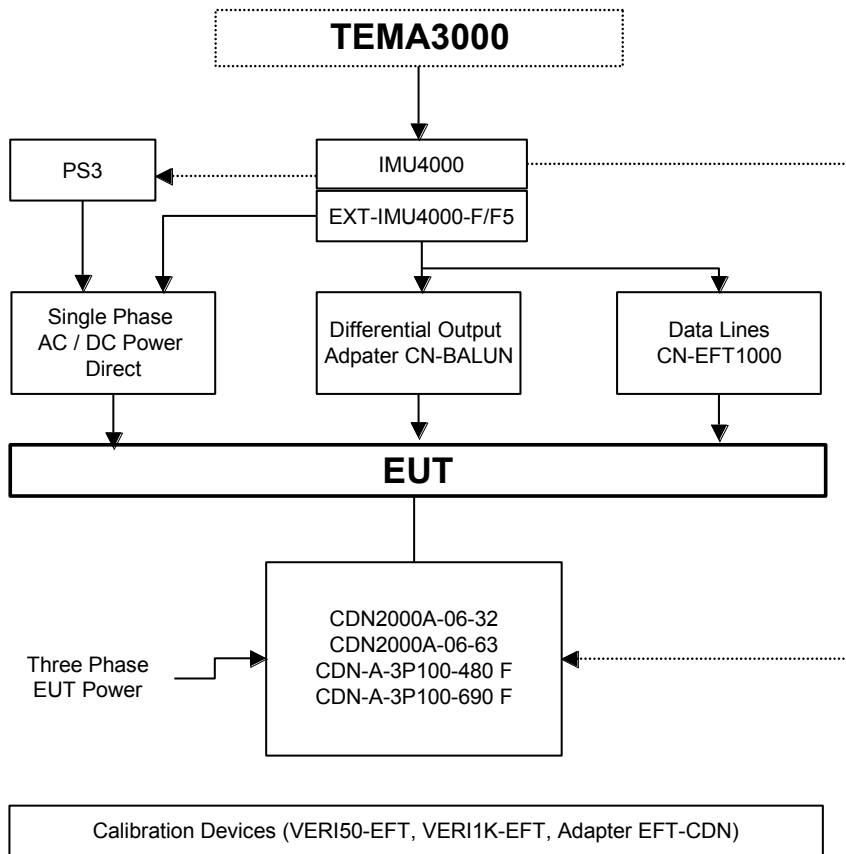

1.2.4 SURGE - IMU4000 System overview

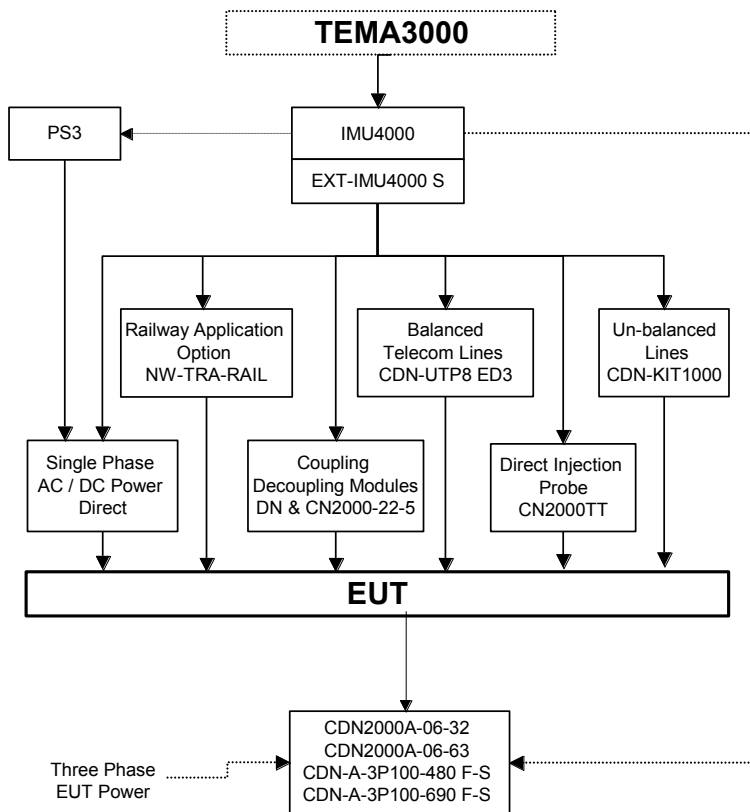

1.2.5 DIPS and Interruption – IMU4000 System overview

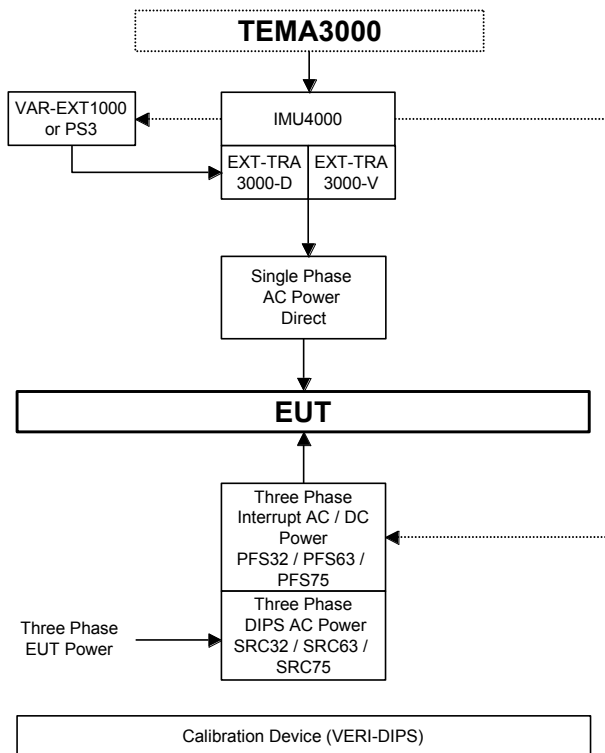

1.2.6 Magnetic fields - IMU4000 System overview IEC 61000-4-8 Ed.2

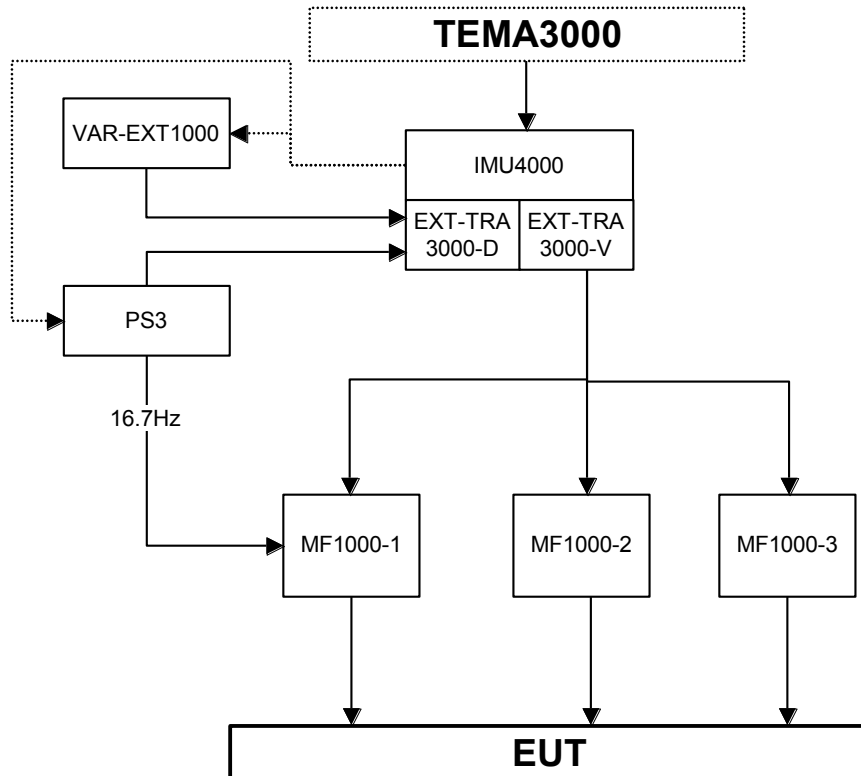

1.2.7 Magnetic fields - IMU4000 System overview IEC 61000-4-9 Ed.1

1.3 Technical data of the IMU4000

1.3.1 Electrostatic discharges ESD only valid with EXT-TRA3000 E

Energy storage capacitance	150 pF		
Discharge resistance	330 Ω		
Charging resistance	54 M Ω		
Holding time (drop to 95%)	better than 5 s		
Current rise time, 2 Ω load	0.8 ns	$\pm 25\%$	See 6.1 IEC 61000-4-2 Ed.2
Definition of current waveform:			
Current amplitude at 30 ns	4 to 16 A	$\pm 30\%$	
Current amplitude at 60 ns	2 to 8 A	$\pm 30\%$	
Voltage range „air discharge“	2 to 15 kV	$\pm 10\%$	
Voltage range „contact discharge“	2 to 10 kV	$\pm 10\%$	
First current amplitude into 2 Ω „contact discharge“	7,5 to 30 A	$\pm 15\%$	
Polarity	positive / negative; automatic switchover		
Number of discharges Detection of the number of discharges	-preselectable -count „every pulse“ -count „discharge only“. Only the impulses where the voltage of the discharge capacitor drops below 10% of the charging voltage are counted.		1 to 29'999
Ramps	voltage amplitude changes from shot to shot, alternate polarity		
Reporting	test sequence with the number of discharges -Voltage amplitude -Polarity		
Discharge modes:	-Air discharge -Contact discharge		
Repetition of the discharges	0.05 up to 30 s Single discharge „Man“		

1.3.2 Electric Fast Transient EFT EXT-IMU4000 F5

Voltage waveform into 50 Ω:	Impulse Output		IEC 61000-4-4 Ed.3
Rise time	5 ns	± 30%	
Half time value	50 ns	± 30%	
Voltage waveform into 1000 Ω:			
Rise time	5 ns	± 30%	
Half time value	50 ns	- 15 ns	+ 100 ns
Adjustable voltage range	250 V to 4100 V	F; F5	250 V to 5100 V
Voltage amplitude into 50 Ω	125 V to 2000 V	± 10%	125 V to 2000 V
Voltage amplitude into 1000 Ω	250 V to 4000 V	± 20%	250 V to 4000 V
Source impedance	50 Ω	± 10%	
Spike frequency IEC 61000-4-4 Ed.3	1 kHz up to 100 kHz	F/ F5	See derating curves
Maximum Spikes per seconds	8'000 at 1000 V	F	1000 at 5000 V
Burst duration	0,01 ms up to 30 ms		
Burst repetition	1 ms up to 1000 ms		
Polarity	positive / negative		
Ramps	-Voltage -Spike frequency -Burst duration		
High voltage output to GND	10 nF decoupled	max. 400 V ac	In any test set up a 33nF capacitor must be inserted

1.3.3 Coupling / De-coupling Network EFT

Maximum continuous EUT power supply voltage	250 V ac 50/60 Hz		
Maximum allowed continuous current	16 A		
Spike waveform superimposed onto the lines of the EUT power supply	within the tolerances as above		IEC 61000-4-4 Ed.3
Coupling paths:	L1+N+PE - GND		Calibrated
Coupling paths:	L1-GND; N-GND, PE-GND, L1 - GND, L1+N - GND, L1+PE to GND		Selectable

Derating curve for EXT-IMU4000 F5

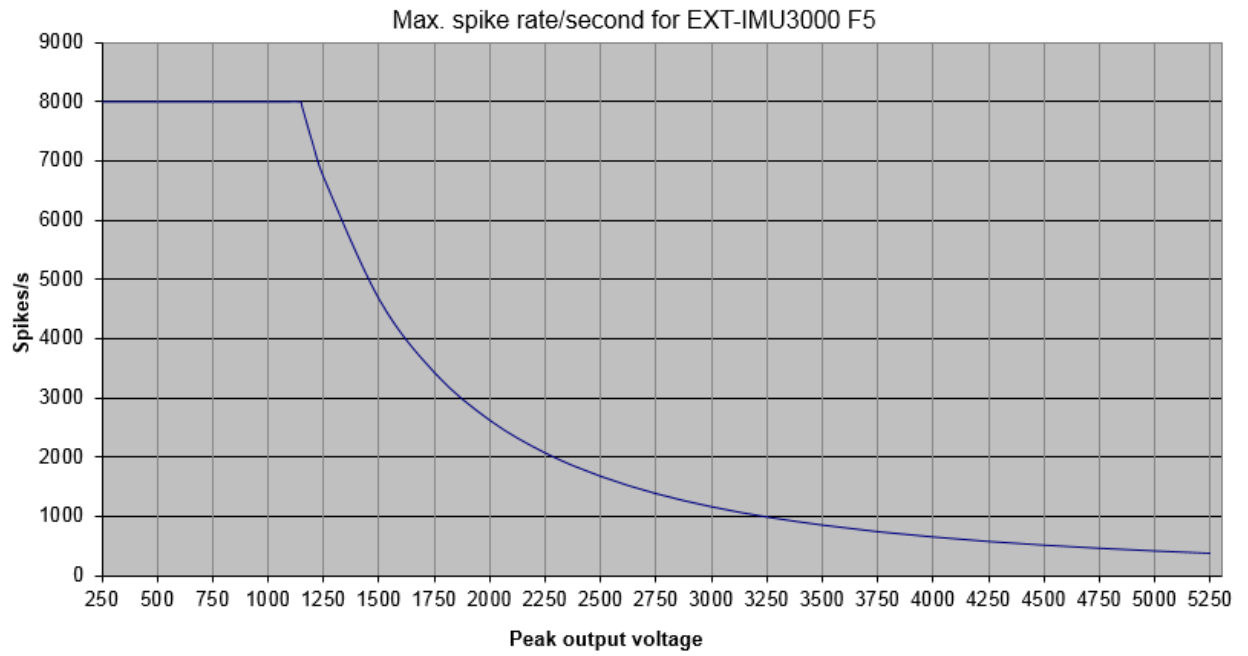

1.3.4 Lightning and switching actions SURGE (IEC 61000-4-5 Ed.3)

Waveform at no load :	Impulse output		See 6.1
Front time	1.2 μ s	$\pm 30\%$	$T_f = 1,67 \times T = 1,2 \pm 30 \%$
Time to half value	50 μ s	$\pm 20\%$	$T_d = T_w = 50 \pm 20 \%$
Waveform at short circuit:			
Front time	8 μ s	$\pm 20\%$	$T_f = 1,25 \times T_r = 8 \mu\text{s} \pm 20 \%$
Time to half value	20 μ s	$\pm 20\%$	$T_d = 1,18 \times T_w = 20 \mu\text{s} \pm 20 \%$
Preselectable voltage range	250V to 4100 V		
Open circuit output range	250 V to 4000 V	$\pm 10\%$	-
Short circuit output current	125 A to 2000 A	$\pm 10\%$	
Output impedance U_{max} / I_{max}	2 Ω		
Polarity	positive / negative		
Ramps	-Voltage -Polarity -Synchronisation		
High voltage output "low" to PE	maximum voltage between „low“ and earth 400V ac		Applicable when external CDN are connected to direct generator output
Time between successive shots	1 s		12s at 8000 V

1.3.5 Coupling / De-coupling Network „CDN-SURGE“

Maximum allowed continuous voltage and current phase neutral	250 V ac 50/60 Hz	16A	
Coupling path phase- earth	9 μ F + 10 Ω	(L-PE)	
Coupling path neutral - earth	9 μ F + 10 Ω	(N-PE)	
Coupling path phase - neutral	18 μ F	(L-N)	
Coupling modes:	L-N; L-PE; N-PE, automatic coupling path switching		



Attention ! The CDN-SURGE 1,2 / 50; 8 / 20 μ s is designed for maximum power consumption at 250V rms 50/60Hz and a coupling capacitance of 18 μ F.

If using coupling de-coupling networks from other manufacturers, the maximum power dissipation of the IMU4000 must be considered. Power Line voltages higher than specified can destroy the impulse forming devices in the IMU4000. Please contact EMC PARTNER AG or a representative before using an unknown coupling network.

1.3.6 Power voltage limits on direct output used together with external SURGE CDN

When voltages higher than 250V between “High” and “Low” of the direct output of the IMU4000 occur a gating will be activated.

The gating can influence the EUT current as the IMU4000 Surge circuit will be turned ON/OFF and act as a load.

1.3.7 Voltage interruption and Variation with internal Variac EXT-TRA3000 D-V

Voltage range	0 to 260 V when EUT power input voltage is 230V	EUT Power	Depending on the EUT power voltage
Frequency range without variac	DC up to 60 Hz		external Source
Frequency range with variac involved	48 Hz to 60 Hz		external Source
Nominal current	16A without internal Variac involved		
Interruption with internal variac and linear load	maximum 12 A maximum 16 A		< 5s < 300 ms
Inrush current	500 A Peak	- 0%, +30%	
Interruption time	50 μ s to 30 s		phase angle selectable
Amplitude of the interruptions	continuously selectable from 0 to 100 %		IEC: 0 %, 40 %, 70 %, 80%
Phase angle for turn ON and OFF of the EUT. Selectable in range	0 to 360°	$\pm 5^\circ$	
Voltage variation with the internal variac	0 to 110 % maximum. 5A	$\pm 20\%$	2 s to 30000 s
Voltage variation with external variac	0 to 110 % maximum. 16 A	$\pm 20\%$	2 s to 30000 s
Less than 1 period	Interruption within one period.		Input as phase angle
More than one period	Interruption longer than one period.		Input in ms
d.c. interruption			Input in ms
Ramps	-Voltage -Synchronisation angle -Interruption time		
Interruption for all kind of loads	DIP	% UT	
UT= voltage at EUT Power 1	100 %	0 %	0 to 16 A



For interruptions of 0 to 100% and 100% to 0% the internal Variac is not involved, therefore the test can be carried up to 16 A. For interruption with UT =EUT Power 1 voltage not zero, the internal variac limits the EUT power current. The maximum allowed current values are listed in the table on the next page. Please be aware that different types of loads influence the maximum current capability.

With internal Variac:

Types of loads:		Variable power consumption maximum 2.6 kW at UT 230 V. With reduction of the voltage the current is also reduced. Examples: Ohmic -, inductive -, capacitive -, mixed loads	Constant power consumption maximum 1,2 kW at UT = 220V. With reduction of the voltage the current is increased. Example: switched power supply	voltage change in % of UT at current change 0 to 100 % UT= voltage at EUT Power 1
switching from	to			
UT	% UT	current range r.m.s	current range r.m.s	% of UT
100 %	0 %	0 to 16A	0 to 16A	0.7 %
100%	80%	0 to 10 A	0 to 5A	4%
100%	70%	0 to 9 A	0 to 6 A	4%
100%	40%	0 to 5 A	0 to 10 A	5%

Note: all values apply for switching time at %UT< 5 s

1.3.8 Interruption and Voltage Variation IEC 61000-4-11 Ed.2 with external Variac

Types of loads:		Variable power consumption maximum 3.7 kW at UT 230 V. With reduction of the voltage the current is also reduced. Examples: Ohmic -, inductive -, capacitive -, mixed loads	Constant power consumption maximum 3,7 kW at UT = 220V. With reduction of the voltage the current is increased. Example: switched power supply	voltage change in % of UT at current change 0 to 100 % UT= voltage at EUT Power 1
switching from	to			
UT	% UT	current range r.m.s	current range r.m.s	% of UT
100 %	0 %	0 to 16A	0 to 16A	0.7 %
100%	80%	0 to 12.8 A	0 to 20A	4%
100%	70%	0 to 11.2 A	0 to 23 A	4%
100%	40%	0 to 6.5 A	0 to 40 A	5%

Note: all values apply for switching time at %UT< 5 s

1.3.9 DIPS circuit in accordance with IEC 61000-4-29 for d.c. power ports.

Voltage range d.c.	20 to max. 300 V	EUT Power	
Current range	0 up to 16A	10A at 300V	See derating curve of PS3
Inrush current capability at 110 V	220A Peak	- 0%, +30%	See 6.1.1
Interruption time	1ms up to 29999 ms		
Rise and fall time at 100 Ohm load	between 1 µs and 50 µs		See 6.1

IEC 61000-4-29 page 19:

The use of a generator with higher or lower voltage/current capability is allowed provided that the other specifications are preserved. The test generator steady state power/current capability shall be at least 20% greater than the EUT power/current ratings.

1.3.10 Synchronisation of IMU4000 to mains frequencies

Synchronisation to EUT power input

A minimum voltage of 30V rms must be applied to the power input on the rear of the IMU4000 (PWR1 or PWR2) to synchronize with the mains.

Generally we recommend the synchronisation to the IMU4000 (PWR1 or PWR2).

Synchronisation to Impulse Out

That the synchronisation via the Impulse Output (Synchro on Output) works correct, the voltage must be > 100Vrms



Caution

When PWR1 is turned OFF the synchronisation signal is disabled. IMU4000 displays a warning „**No synchronisation**”

1.3.11 Measuring circuit, measuring outputs

Monitor outputs for measuring equipment e. g. oscilloscope:

Outputs	Relations	Tolerance	Ranges
S Voltage	10 V equals 4000 V	± 3 %	250V to 4000 V
SURGE Current	10 V equals 2000 A	±3 %	125A to 2000 A
EUT Power Voltage	10 V equals 400 V	±3 %	24V to 250 V
EUT Power Current	10 V equals 100 A	±3 %	1 to 16 A

Additional ranges are implemented in IMU4000 depending on coupling path (Impedance) and wave shapes. The relation between the CRO voltages and CRO current to the high voltage/current will be displayed in the operating windows.

Numeric measurements e.g. measuring values in the display and in the report.

Display	Relations	Tolerance	Ranges
SURGE Voltage Peak value		±3 %	500 to 4000 V
SURGE Current Peak value		±3 %	250 to 2000 A
EUT Power Voltage (rms)		±3 %	24 to 250 V
EUT Power Current (rms)		±3 %	2.5 to 16 A

1.3.12 Trigger Output Levels

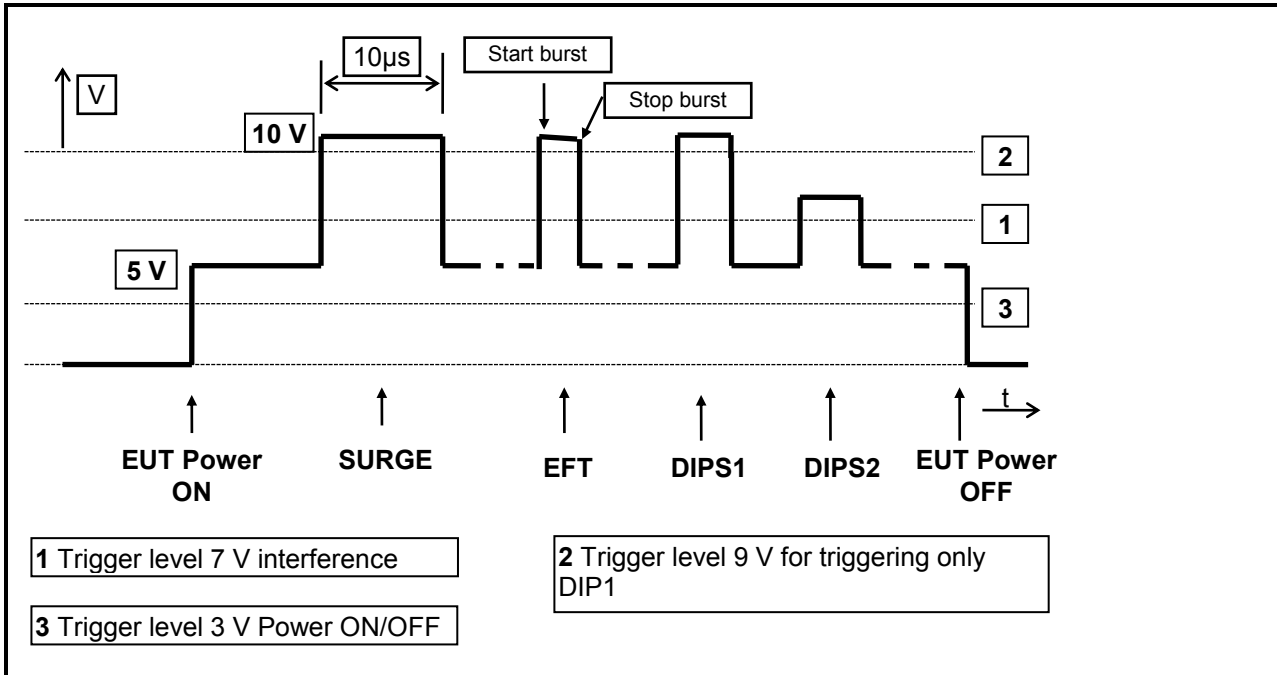

1.3.13 Control

Set-up memory	8 Gbit for setups, protocols, etc.
Test sequences	15 set-ups can be linked serially
Impulse release	Manual or automatic
Failure detection on EUT	-Manual detection -Selectable limit value for impulse voltage and current for SURGE
Safety switching	Emergency stop Switch off the EMC Test and the EUT power
Control of an external variac	separate remote-control output
Failure analysis report, servicing	USB port with USB stick. USB stick delivered with IMU4000
Control of external CDN	via RS 485 port
Remote control from TEMA3000	Ethernet

1.4 Mechanical dimensions

Tester -Type	Dimensions [mm]	Weight [kg]	Versions
	width x depth x height		
IMU4000 and all Versions	550 x 600 x 190	See standard accessories list	19" 8 UH

1.5 Power Consumption

The power line input is located on the rear side of the IMU4000.

Voltage between phase and neutral	100V up to 250V	50 up to 60Hz
Power consumption	Standby: power cord connected, switch turned "OFF"	< 1W
	Power "ON" no EMC test running	75W
	Power "ON" EMC test running	<150VA

Power cords see next paragraph „Accessories delivered with the TRA3000

1.6 Included articles, dimensions

Included Articles

According to STL-Variante 20, STL-Version 1

Qty	PN	Description
1	103194	CD-UM-IN-ALL includes all User Manuals and Instruction sheets of all EMC PARTNER AG sales products.
1	106755	Brochure IMU4000
3	104821	Standard calibration certificate(s) for built-in EXT-TRA3000
1	103191	Standard accessories pack
1	104816	Power Cord 3 pole (10/13/16A)
1	103081	EUT Power Connection 1ph, 1 set of 3 cables (2m) with banana plugs, black, blue and yellow/green
1	104537	Patch cord cat. 5e FTP type crossover to CTRL3000, red, 3m
1	104539	USB Stick 2GB to generator equipped with CTRL3000 or EPOS

Article-No.	Type	Height Units	Length (cm)	Width (cm)	Height (cm)	Net Weight (kg)
106758	IMU4000 C	4	57	45	19	17
106757	IMU4000 D	4	57	45	19	23
106774	IMU4000 D-C	4	57	45	19	25
106760	IMU4000 D-V	4	57	45	19	23
106765	IMU4000 D-V-C	4	57	45	19	25
106753	IMU4000 F	4	57	45	19	18
106770	IMU4000 F-C	4	57	45	19	19
106763	IMU4000 F-D-V	4	57	45	19	25
106759	IMU4000 F-S	4	57	45	19	20

106766	IMU4000 F-S-C	4	57	45	19	21
106771	IMU4000 F-S-D	4	57	45	19	21
106776	IMU4000 F-S-D-C	4	57	45	19	27
106767	IMU4000 F-S-D-V	4	57	45	19	27
106769	IMU4000 F-S-D-V-C	4	57	45	19	27
106761	IMU4000 F-V	4	57	45	19	24
106777	IMU4000 F5	4	57	45	19	18
106781	IMU4000 F5-C	4	57	45	19	19
106783	IMU4000 F5-D-V	4	57	45	19	25
106778	IMU4000 F5-S	4	57	45	19	20
106784	IMU4000 F5-S-C	4	57	45	19	21
106782	IMU4000 F5-S-D	4	57	45	19	21
106785	IMU4000 F5-S-D-C	4	57	45	19	27
106779	IMU4000 F5-S-D-V	4	57	45	19	27
106786	IMU4000 F5-S-D-V-C	4	57	45	19	27
106780	IMU4000 F5-V	4	57	45	19	24
106756	IMU4000 S	4	57	45	19	19
106772	IMU4000 S-C	4	57	45	19	19
106764	IMU4000 S-D-V	4	57	45	19	26
106768	IMU4000 S-D-V-C	4	57	45	19	27
106762	IMU4000 S-V	4	57	45	19	25
106775	IMU4000 V	4	57	45	19	18
106896	EXT-IMU4000 F		41	16	8	2.1
106898	EXT-IMU4000 F5		41	16	8	2.1
106897	EXT-IMU4000 S		32	23	17	2.6

1.7 Standard accessories

Accessories to IMU4000 Neutral (Article No. 106754)

Qty	PN	Description	Weight (kg)	Length (cm)	Width (cm)	Height (cm)
2	102523	Spare fuse T16A	0	3.2	0.63	0
1	102524	Spare fuse 4AT	0	2	0.5	0
1	102525	Spare fuse T5A	0	2	0.5	0
1	103015	Plastic pack for standard accessories 90x75mm	0	9	7.5	0
1	103027	Accessory plastic pack	0	0	0	0
1	103163	Adapter SCHUKO / 3x MC protected banana plugs	0	0	0	0

2 Safety

The IMU4000 belongs to Safety class 1

2.1 Safety standard

The IMU4000 fulfils the requirements of the safety standards IEC 61010 for laboratory measurements equipment „Safety requirements for electrical measuring, control and laboratory equipment“. Based on EN 61010 the declaration of conformity to low voltage directive (LVD 73/23/EEC O.J.N° L77, 1973-03-26) is given.



This manual is an integral part of the IMU4000 tester. The instructions contained in the manual regarding operation and the test set up are to be strictly observed

2.2 Climatic Conditions

The IMU4000 contains high voltage circuits in integrated form. EMC PARTNER only guarantees a correct functioning of the tester IMU4000 and the associated accessories, if the IMU4000 is operated in the climatic conditions specified.

Temperature	15 °C to 35 °C	
Relative humidity	45 % to 75 %	
Atmospheric pressure	86 kPa to 106 kPa	(860 to 1060 mbar)
Not influenced by:	direct solar radiation, rain or condensation water, dust or larger electro magnetic fields as specified in the EMC compatibility chapter.	

The IMU4000 should be operated in a dry, clean room. If for any reason condensation water is present in the IMU4000, then no IMU4000 operation should be started before the tester is thoroughly dry.



It is strictly forbidden to operate the IMU4000 in rooms with a gas explosion risk. The high voltage of the IMU4000 can generate sparks, which could ignite gases



People with heart pacemakers should not be in the vicinity of the test set up during operation

2.3 Precautionary measure during use

The IMU4000 generates high voltages. The energy content of the SURGE impulse is high and can be dangerous with improper use. It is wise to observe the following rules:

• Never touch the EUT when a test is in operation.
• Touch no connectors of interconnection cable when a EMC test is in operation.
• The high voltage of the IMU4000 and the power on the EUT must be turned off before a manipulation on the EUT is carried out.
• For all services, e.g. check of the fuses, the power cord must first be unplugged.

The IMU4000 must be connected to power line with a safety ground. If an isolation transformer is involved in IMU4000 supply the secondary side of the isolating transformer must be grounded.

2.4 Electromagnetic Compatibility

The outputs of the IMU4000 and the links between IMU4000 and the EUT can emit disturbances. Please consider the national rules.

The Test System IMU4000 should not be operated near sensitive measuring and control systems.

The IMU4000 fulfils the following immunity requirements:

• Electrostatic discharge	4 kV	IEC 61000-4-2 ED2
• Burst EFT	1 kV	IEC 61000-4-4 ED3
• SURGE	1 kV	IEC 61000-4-5 ED3

2.5 The manual is an integral part of the equipment. Refer to the manual.

	<p>This manual is an integral part of the IMU4000. The safety rules and precautions in the manual must be observed. EMC PARTNER and their representatives are not responsible for damage to persons and equipment by non observance of safety rules and precautions in the manual.</p>
---	---

2.6 Sécurité

L'appareil de test IMU4000 est un équipement de la classe de sécurité 1

2.6.1 Normes de sécurité

L'appareil de test répond aux exigences des normes de sécurité CEI 61010 (Règles de sécurité pour appareils électriques de mesurage, de régulation et de laboratoire) et à la norme de sécurité VDE 0104 (Circuits de sécurité, lampes d'avertissement ou connecteurs pour les lampes d'avertissement). Le produit satisfait aux exigences de la directive basse tension LVD 73/23/CEE (JO n° L77, 1973-03-26). L'observation de cette directive a été contrôlée selon DIN EN 61010 (correspond à CEI 61010).



Ce manuel est une partie intégrante de l'appareil de test IMU4000. Les instructions contenues dans le manuel en ce qui concerne le fonctionnement et l'installation d'essai, doivent être strictement respectées

2.6.2 Conditions climatiques

L'appareil de test contient des circuits haute tension sous forme intégrée. EMC PARTNER ne garantit le bon fonctionnement de l'appareil et des ses accessoires, que s'il est utilisé dans les conditions climatiques spécifiées ci-dessous.

Température	15 ° C à 35 ° C	60 à 90 ° F
Humidité relative	45% à 75%	12,9 à 15,4 psi
Pression atmosphérique	86 kPa à 106 kPa	(860 à 1060 mbar)
Ne pas exposer à:	rayonnement solaire direct, pluie ou eau de condensation, poussière ou un niveau plus important de champ électromagnétique que spécifié dans le chapitre sur la compatibilité électromagnétique.	

L'appareil devrait être utilisé dans un endroit propre et sec. Si pour une raison quelconque de l'eau se condense dans l'appareil, aucun test ne devra être effectué avant que l'appareil soit sec.



Il est strictement interdit de faire fonctionner l'appareil dans des endroits contenant des gaz avec risque d'explosion. La haute tension de l'appareil peut générer des étincelles qui pourraient enflammer le gaz.



Les personnes portant un stimulateur cardiaque ne doivent pas être à proximité de l'installation d'essai en cours d'opération

2.6.3 Mesures de précaution lors de l'utilisation

L'appareil de test IMU4000 est une source de puissance. L'énergie à la sortie de celle-ci est élevée et peut être dangereuse si elle n'est pas utilisée correctement. Il est conseillé d'observer les règles suivantes:

- | |
|--|
| • Ne jamais toucher le EST (équipement sous test) quand un test est en fonctionnement |
| • Ne jamais toucher les connecteurs ou les câbles quand un test CEM est en marche. |
| • Avant toute manipulation de l'EST, s'assurer que l'appareil de test est désactivée et que l'EST est déclenché. |
| • En cas de service, comme vérifier les fusibles, le cordon d'alimentation doit être débranché. |

L'appareil de test IMU4000 doit être connecté à une ligne électrique avec liaison à la terre. Si un transformateur d'isolement est utilisé, le côté secondaire doit être mis à la terre.

2.6.4 Compatibilité électromagnétique

Les sorties de l'appareil de test IMU4000 et les câbles de connexion du système à l'EST peuvent émettre des perturbations. Veuillez s'il vous plaît examiner les règlements nationaux applicables à l'environnement local.

L'appareil de test IMU4000 ne devrait pas être utilisé à proximité de systèmes de mesure et de contrôle sensibles.

L'appareil satisfait aux exigences d'immunité suivantes:

• décharges électrostatique	4 kV	IEC 61000-4-2 ED2
• Burst EFT	1 kV	IEC 61000-4-4 ED3
• SURGE	1 kV	IEC 61000-4-5 ED3

2.6.5 Le manuel fait partie intégrante de l'équipement.



Ce manuel fait partie intégrante du IMU4000. Les règles de sécurité et les précautions à prendre dans le manuel doivent être respectées. EMC PARTNER et ses représentants ne sont pas responsables des dommages causés aux personnes et au matériel découlant du non-respect des règles de sécurité et des précautions à prendre citées dans le manuel

2.7 Sicherheit

IMU4000 entspricht der Schutzklasse I. IMU4000 darf nur mit einem Versorgungskabel mit enthaltenem Schutzleiter betrieben werden.

2.7.1 Sicherheit Standard

IMU4000 erfüllt alle Anforderungen nach Sicherheit Standard IEC61010 „Safety requirements for electrical equipment for measurement, control and laboratory use. Basierend auf EN 61010 (IEC 61010) ist die Deklaration zur Einhaltung der Niederspannungsrichtlinie LVD 73/23/EEC (O.J. N° L77, 1973-03-26) gegeben.



Dieses Manual ist Bestandteil des IMU4000 Generators. Alle im Manual befindlichen Hinweise und Anweisungen sowie Testkonfigurationen sind strikte einzuhalten

2.7.2 Klimatische Bedingungen

Die unten aufgeführten klimatischen Bedingungen müssen für einen einwandfreien Betrieb eingehalten werden.

Temperatur	15 °C bis 35 °C	60 bis 90°F
Relative Luftfeuchtigkeit	45 % bis 75 %	12.9 bis 15.4 PSI
Atmosphärischer Druck	86 kPa bis 106 kPa	(860 bis 1060 mbar)
Keine Einwirkung von:	Bei direkter Sonneneinstrahlung, Regen, Staub, starken elektromagnetischen Felder als spezifiziert unter "Elektromagnetische Verträglichkeit"	

IMU4000 darf nur in trockener und sauberer Umgebung betrieben werden. Ist aus irgendwelchen Gründen Kondenswasser im IMU4000 zu erkennen, muss IMU4000 vor Inbetriebnahme vollständig austrocknen.



IMU4000 darf nicht in explosionsgefährdeten Zonen betrieben werden.



Personen mit Herzschrittmacher sollten sich während dem Betrieb nicht in unmittelbarer Nähe aufhalten.

2.7.3 Vorsichtsmassnahmen während dem Betrieb

IMU4000 kann Hochspannung an den Anschlüssen führen. Bei unsachgemässer Bedienung entstehen grosse Gefahrenquellen. Folgende Regeln müssen beachtet und eingehalten werden.

Nie während einem Test den Prüfling (EUT) berühren
Nie Steckverbindungen oder Kabel berühren wenn ein EMC Test abläuft.
Vor dem Berühren des Prüflings sicherstellen, dass dieser Spannungslos ist. Entladezeiten interner Speicherladungen beachten.
Für alle Servicearbeiten (Sicherungswechsel) muss das Versorgungskabel (MAINS SUPPLY) aus gesteckt werden.

Der IMU4000 darf nur an ein Speisernetz mit Nullleiter und Schutzerde angeschlossen werden. Wenn ein Isolationstransformator verwendet wird muss die Sekundärseite mit der Schutzerde verbunden werden.

2.7.4 Elektromagnetische Verträglichkeit

Der Power Output von IMU4000 und die Anschlusskabel zum Prüfling können Störfelder abstrahlen. Die örtlichen Bestimmungen müssen berücksichtigt werden.

IMU4000 nicht in unmittelbarer Nähe von empfindlichen Messgeräten betrieben. Die Messergebnisse könnten beeinflusst werden.

IMU4000 erfüllt die folgenden Störfestigkeiten:

Elektrostatische Entladung	4 kV	IEC 61000-4-2 ED2
Burst EFT	1 kV	IEC 61000-4-4 ED3
SURGE	1 kV	IEC 61000-4-5 ED3



Beachten Sie alle Angaben in der Bedienungsanleitung

2.7.5 Dieses Manual ist Bestandteil von IMU4000 und dessen Testumgebung.



Die enthaltenen Sicherheitsbestimmungen und Vorsichtsmassnahmen müssen eingehalten werden. Bei deren Nichteinhaltung übernimmt EMC PARTNER und deren Vertreter bei Schaden an Personen oder Messeinrichtungen keine Verantwortung.

3 Mechanical structure

3.1 General

The IMU4000 is ideal for running tests in development/test laboratory environments and for outdoor service on larger systems. For outdoor service, the IMU4000 can be fitted into a military case.

For better understanding, the IMU4000 will be divided into two parts:

- The left hand part of the IMU4000 contain the control and measurements. The left hand side of the front panel, is called the control panel.
- The right hand part contains all high voltage circuits, such us high voltage source, high voltage switches, the impulse-forming network and the coupling / de-coupling network. This part is called the operation panel.



Fig.3.1

The power connections of the IMU4000 and the EUT are located on the rear panel. With the EUT power inputs on the rear side and the outputs on the front side an optimum de-coupling is guaranteed. This arrangement allows test set-up without parallel-running cables.

The IMU4000 is available with different options:

Standard with handles on both side as showed in Figure 3.1. This version is recommended for use in development and EMC test laboratories.

19" insert version. The handles are removed and angle brackets are fixed on both sides for fitting the IMU4000 in a 19" rack. When the IMU4000 is equipped with an EFT circuit the EFT output must be maximum 50 cm above the reference ground plane.

Standard with handle in a military case. This version is recommended for outdoor EMC testing.

3.2 Impulse-forming Networks

The high voltage source, the polarity change-over switch, the impulse capacitors, the semiconductor switch and the impulse forming networks are located behind the operation panel.

The impulse capacitor Cs is charged by the high voltage source. The discharge of the high voltage capacitor is done via the semiconductor switches. The impulses are formed by the different impulse forming networks.

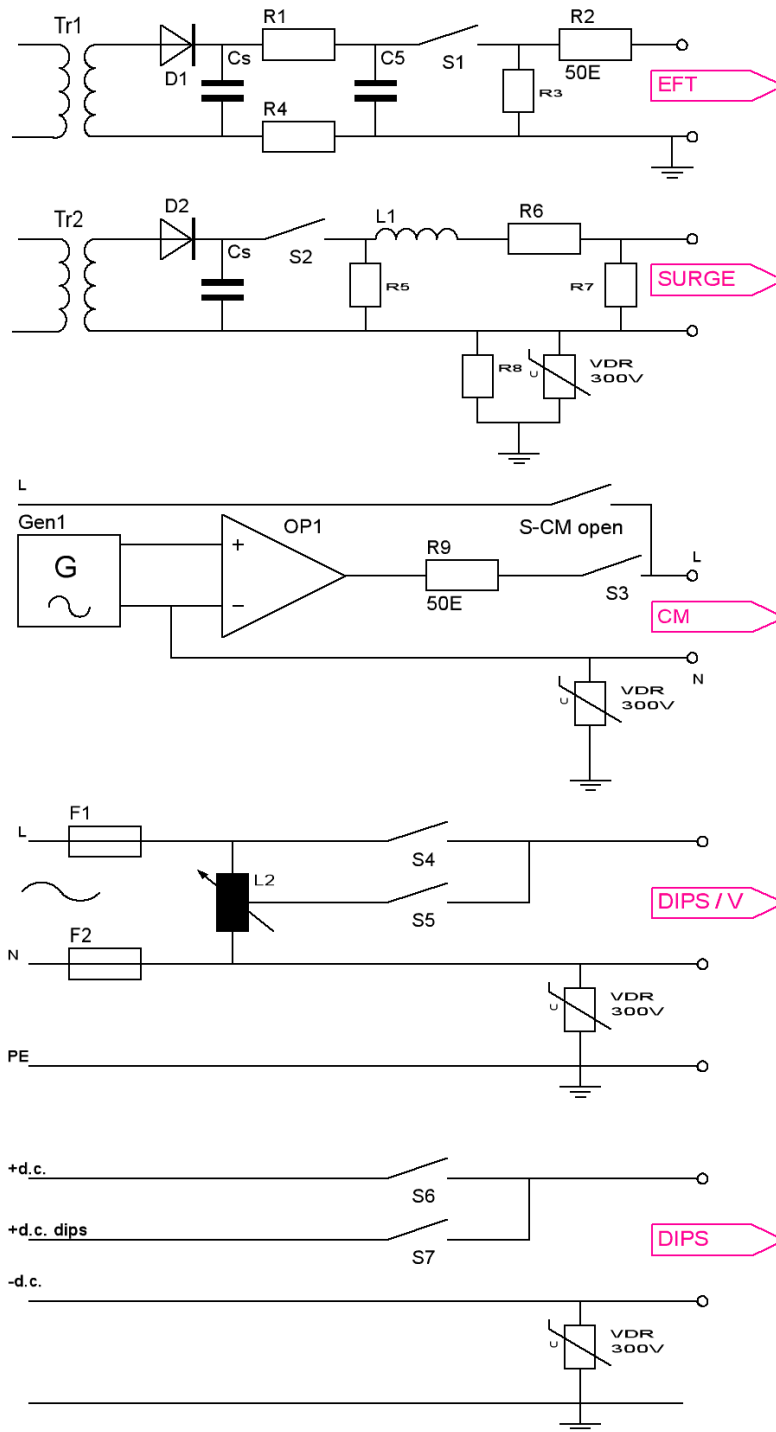

3.3 Measuring Circuit

The SURGE impulse voltage is measured differentially with two internally-located voltage dividers. The current is measured with a current monitor with differential amplifier. The peak values of voltage and current are memorised and shown in the display. With the two CRO outputs, the voltage and current waveform can be monitored on a oscilloscope.

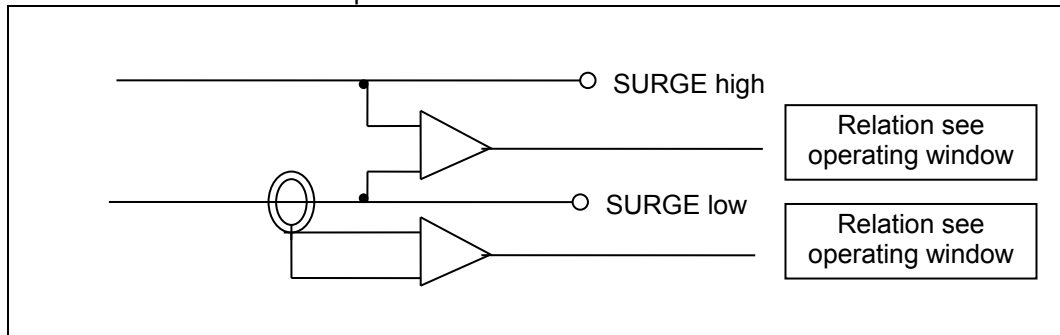

fig. 3.2

3.4 Coupling / De-coupling Network CDN

The coupling / de-coupling network (CDN) of the IMU4000 allows superimposition of impulses onto the power line of the EUT. Switching of the different coupling paths can be programmed. For the voltage DIPS test, the de-coupling network is automatically by-passed.

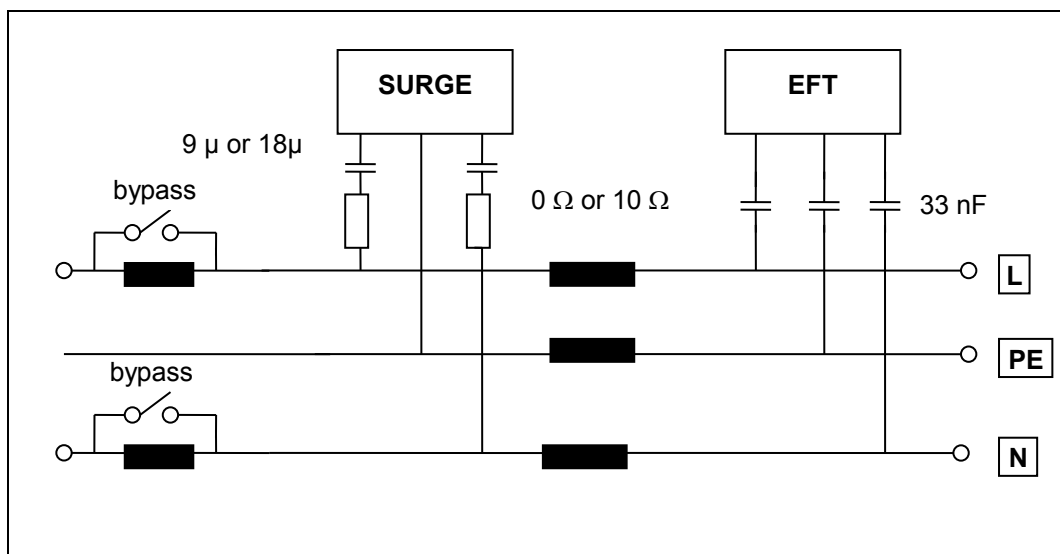

fig. 3.3

3.5 EUT power supply at DIPS

In the operation mode (DIPS voltage interruption), the switch S1 turns on the EUT Power 1 power source (undisturbed level). S2 turns on the power to EUT Power 2 (disturbed level). The internal variac can be replaced by an external variac or PS3 power supply and therefore the EUT Power 2 can be generated by internal or external means.



For DIP testing, the NEUTRAL must be close to earth potential (PE). If voltage is present on the Neutral an error will be shown on the IMU4000 display. If the Neutral is not close to earth potential, an isolation transformer must be used between the mains supply and IMU4000 input.

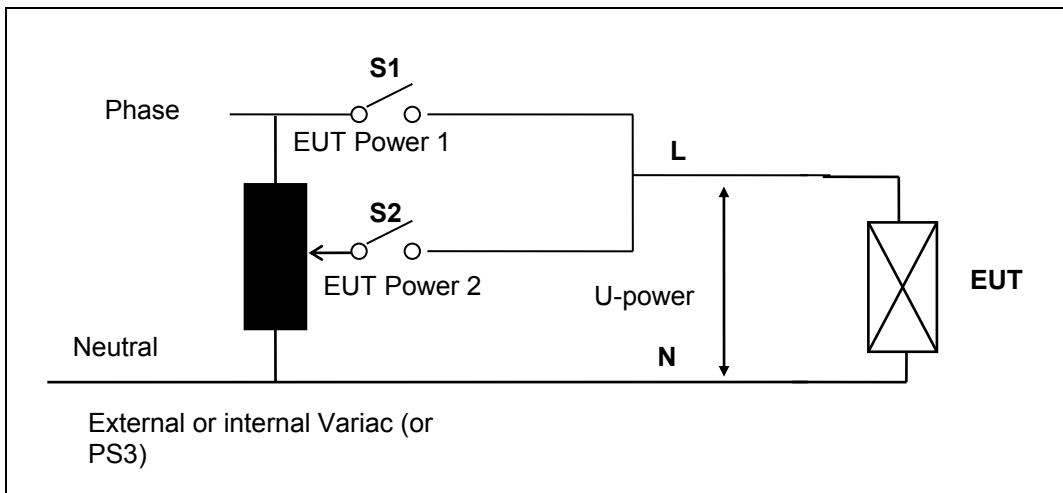

fig. 3.4

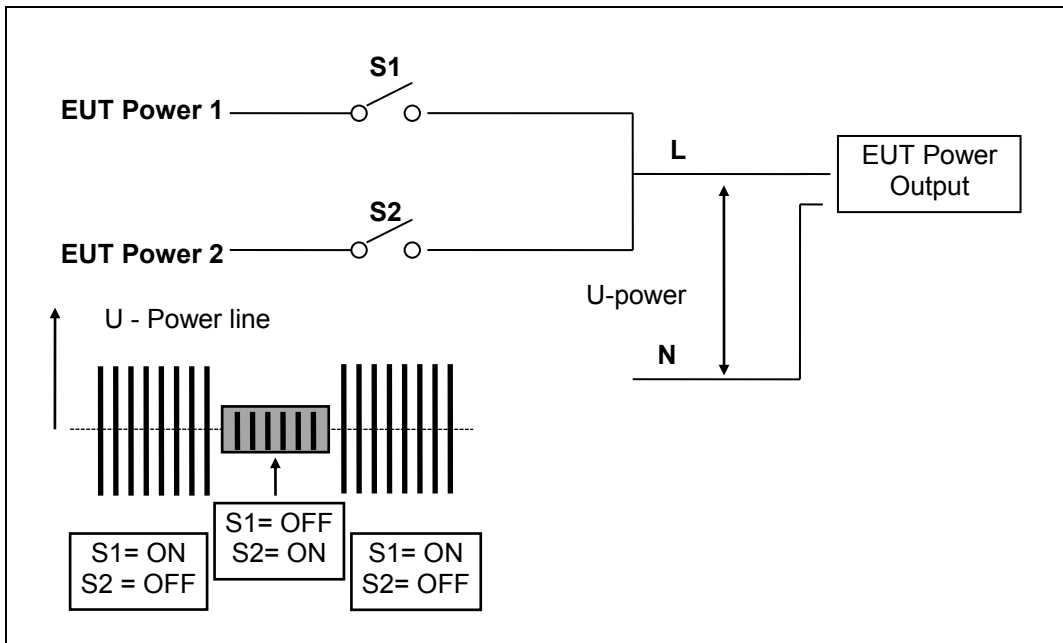

Fig. 3.4

At DIPS to 0 % of the power line voltage, two operating conditions can be differentiated:

- a) Switch S1 is opened, the voltage of the power decreases at the EUT with the discharge constant of the EUT (High Z at 0% = ON)
- b) Some μ s after switch S1 has opened, switch S2 will be closed and the EUT will be discharged via the circuit EUT Power 2 (High Z at 0% = OFF).

AT High - Z Mode = OFF and large capacitive loads, the large capacitance will be discharged via the internal variac at the beginning of the interruption. A large current will result, if an interruption to 0% of the power line voltage is generated. To avoid reducing the life span of the carbon contact electrode of the variac, it is recommended to make a short circuit with an external bridge between L2 and N of EUT Power 2.



Vrms between EUT Power 1 and EUT Power 2 must be lower than 250V. Use for EUT Power 1 and 2 equal phase L.
 The maximum voltage on the inputs of EUT power 1 or EUT power 2 must be lower than 280V.
 High voltages will destroy the varistors on the inputs.

4 Control Panel

4.1 Front panel of the IMU4000



fig.4.1

The most important elements of the front panel are:

1. Control panel, touch screen monitor
2. Operation panel
3. Handles or angle bracket for the 19" rack
4. Large surface earth connection

The controls on the front and rear panels are protected by the handles (3).

For indications, the follow colours are generally used:

green	Power on
read	EMC Tests active, high voltage
yellow	General signals

4.1.1 Control part

Control of the IMU4000 is carried out by internal computer. The computer controls the EMC tests, stores the inputs of the numeric input terminal, updates the graphic monitor, checks whether the inputs of the operators are valid values or not, stores the program and prepares test reports. The operator communicates with the IMU4000 via the graphic input terminal, the display and the soft keys.

For better understanding, the control panel elements will be explained separately from the connection panel.

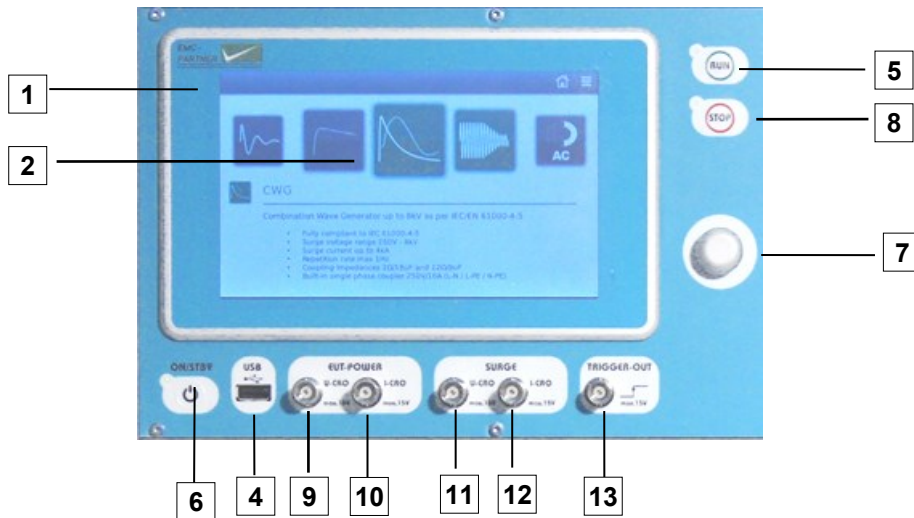

fig. 4.1.1

4.1.1.1 The touch screen monitor (1)

All important information for the operator is permanently shown on the monitor during EMC testing. The large graphic display includes hints or setting range information.

4.1.1.2 Selection of the possible EMC tests (2)

The program in the IMU4000 is very complex, therefore each emc tests has his own selection logo. When the Hardware is inserted automatically the EMC logo is activated (green background).

4.1.1.3 The USB Port (4)

Via this interface, service data can be stored on a USB stick. In case of failure the data can be sent via Email to EMC PARTNER for analysis.

4.1.1.4 Button Run (5)

With the „Run“ button, a test can be started.

4.1.1.5 Push button ON/STBY (6)

With this button, the IMU4000 will be set into the power ON / OFF mode. In the turn off mode, the control and the signals are deactivated. In Standby IMU4000, power consumption is at a minimum of 5 W.

4.1.1.6 Rotary knob for selecting test parameter and Enter (7)

If the cursor is activated in one line of the display, then data can be input with the rotary knob. Each data input must be terminated with ENTER by pressing the rotary knob.

4.1.1.7 Button STOP (8)

With the „STOP“ button, a test can be stopped or interrupted.

4.1.1.8 Measuring outputs EUT Power Voltage (9) and Current (10)

A signal corresponding to the mains voltage is available at these two BNC outputs „EUT power“. Maximum 12 V for the voltage at the output (9) and maximum 12 V for the current at the output (10).

4.1.1.9 Measuring outputs SURGE Voltage (11) and Current (12)

During SURGE tests, voltage sequence of the SURGE waveform can be measured at the output socket (11) and the current sequence at output socket (12). The range and the accuracy of the measuring system is given in the Chapter 1.2 Technical data Section 1.2.8 measuring circuits, measuring outputs.

4.1.1.10 Trigger output for oscilloscope (13)

This output provides all the necessary trigger impulses for the different tests. The different trigger levels and the time delays are listed in Chapter 1.2 Technical data paragraph 1.3.13

4.1.2 Operation panel

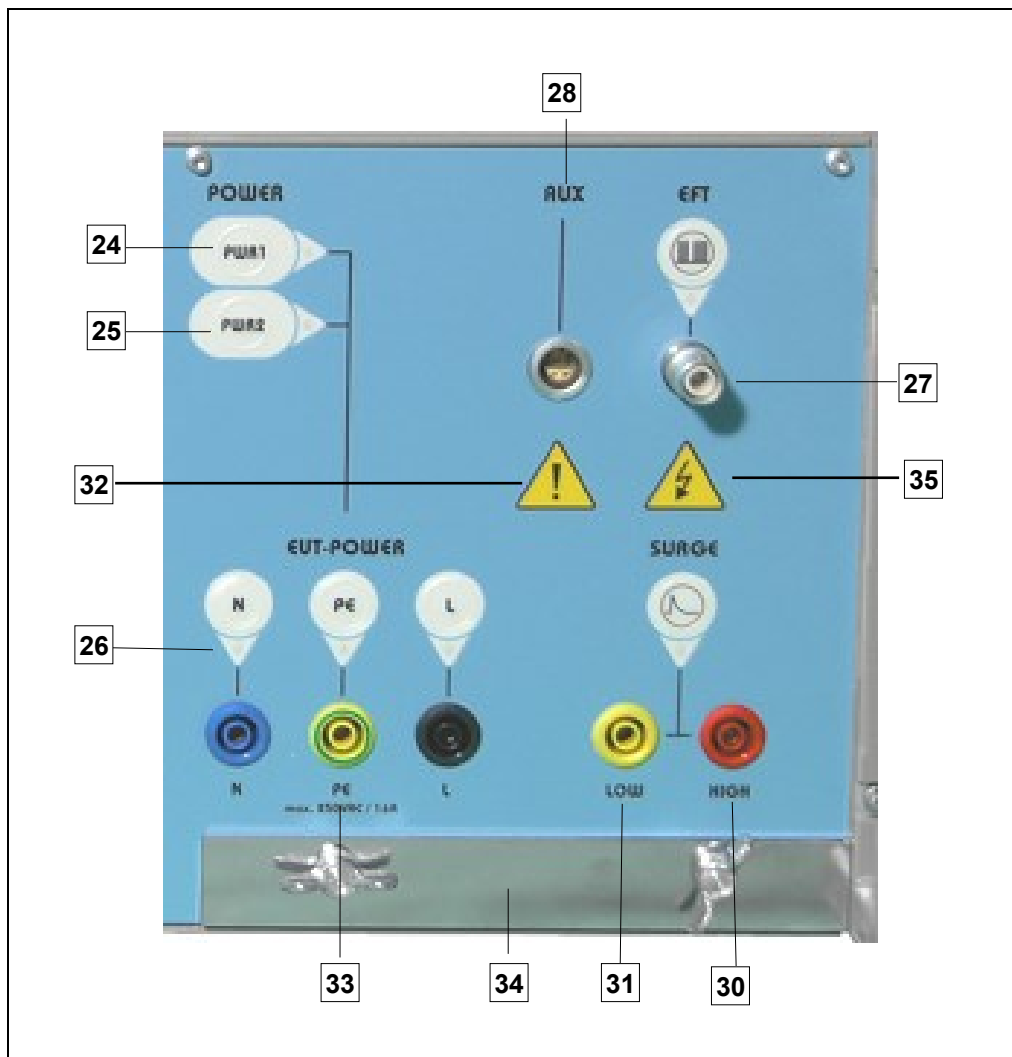

Fig. 4.1.2

4.1.2.1 Indication of the coupling path (26)

The three LEDs indicate which path is receiving the disturbance. The three lines of the EUT power, or the direct high voltage outputs. The indications are active when Run is pressed. Coupling path can be changed during operation using the buttons above the LED indicators.

4.1.2.2 Single phase power banana plug (33) type.

When superposing disturbances onto the EUT power line, the power cord of the EUT must be connected. EMC PARTNER offers adapters for the different types of power cord connectors for different countries.

4.1.2.3 Button Power LINE PWR1 (24)

With this button the EUT power is turned on or off at the phase angle defined.

4.1.2.4 Button PWR2 (25)

With this button the EUT power is turned on from the variac. When the power of the EUT is feed from input (48) (see Figure 4.2) e.g. internal or external variac, this status will be indicated by the LED (25) .

4.1.2.5 High voltage pulse output EFT (27)

This output is needed to run EMC tests with the external capacitive coupling clamp or an additional coupling/de-coupling network.

4.1.2.6 Impulse output SURGE (30,31)

These two connectors are for connecting external accessories such as coupling kit, three phase coupling/de-coupling networks or telecom CDN. See IMU4000 accessories.

The outputs are marked with „high“ and „low“. The „low“ output is not earthed, and a maximum external voltage of 280 V ac can be connected, as described on the front panel.

4.1.2.7 High voltage (35)

Attention high voltage at the EFT BNC plug) and SURGE (MC plugs)

4.1.2.8 Earth connection (34)

Particularly for interference tests with high frequency components, such as EFT, a large surface earth connection is necessary. The earth terminal of the IMU4000 allows a low inductance earth connection between test equipment and the reference ground plane to be made.

4.1.2.9 Attention, refer to manual (32)

This sign tells the operator to study the manual in detail. Only trained personnel are allowed to operate the IMU4000.

4.1.2.10 Aux Auxillary (28)

To connect the EXT-TRA3000 E for ESD testing .

4.2 Rear Panel of the IMU4000

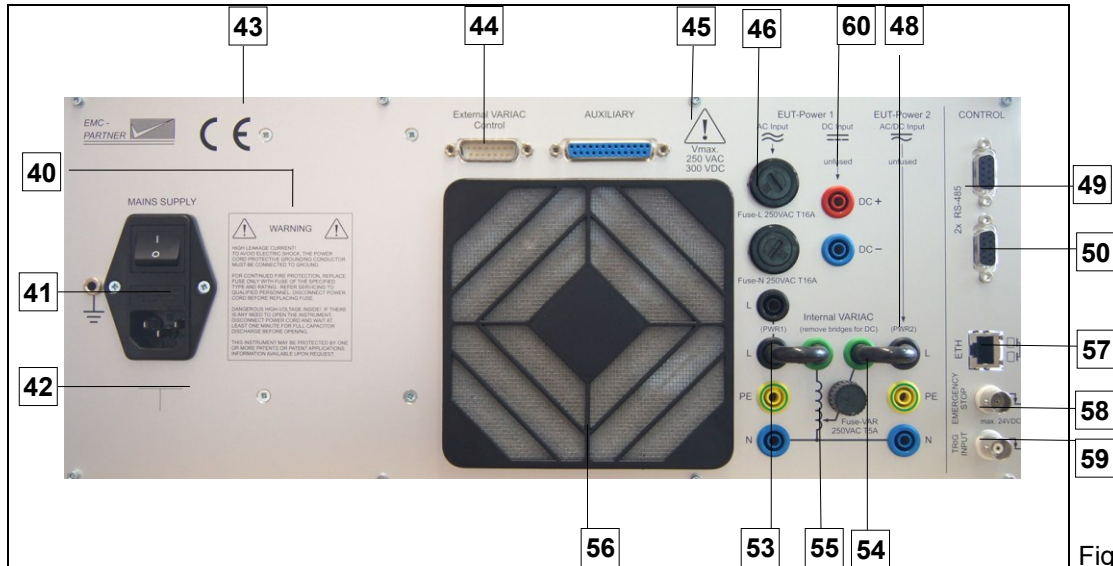

Fig. 4.2

4.2.1.1 Warnings (40)

High leakage currents. To avoid electric shock the power cord protective grounding conductor must be connected to ground.

For continued fire protection, replace fuse only with fuse of the specified type and rating. Refer servicing to qualified personnel. Disconnect power cord before replacing fuse.

Dangerous high-voltage inside. If there is any need to open the instrument, disconnect power cord and wait at least one minute for full capacitor discharge before opening.

This instrument may be protected by one or more patents or patent applications. Information available upon request.

4.2.1.2 Power supply of the IMU4000 (41)

The IMU4000 receives its power via power connection (41). A power switch, a fuse and a filter are built in directly at the mains plug.

Power consumption: turned "ON" minimum < 75VA; maximum power consumption < 150 W, standby < 1 W
The fuse is rated with T 4A / 250 V.

4.2.1.3 Type plate (42)

All important supply information is written on the type plate. Please quote the serial number and type of the equipment when requesting service or repair. Type plate

4.2.1.4 CE mark (43)

The CE -mark is needed for the free movement of the goods into and within the European community.

4.2.1.5 External Variac Control, external synchronisation (44)

Via this special interface, the external variac can be controlled by the IMU4000 V. The external variac is needed for EUT (>12 A) and mains voltage variation (>5A).

External synchronisation

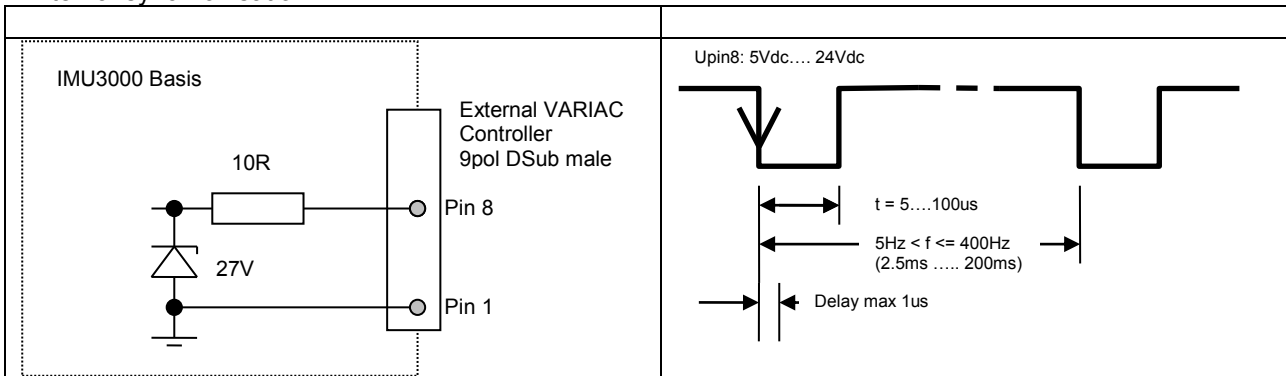

4.2.1.6 Attention, refer to manual (45)

This expression requests the operator to consult the manual in detail. Only trained personnel are allowed to operate the IMU4000.

4.2.1.7 EUT Power 1; Inputs (46,53)

All input plugs and fuses for EUT power 1 are located in row (46). The two 16 A fuses for phase and neutral located above. Below the fuses are the three power line connections for the EUT power supply (53). For the phase, two plugs are available for connecting the internal variac to the power. For external variac operation, the bridge (53) and (54) must be removed, see Chapter 6 „Testing with the IMU4000 D-V“.

Supply data: min. 20 to max. 250 V a.c 16A

Supply data: min. 20 to max. 110 V d.c 10A. Only applicable for TRA versions without EXT TRA3000 ..D-V included. When the EXT-TRA3000D-V is included see 4.2.1.9 and 4.1.2.17

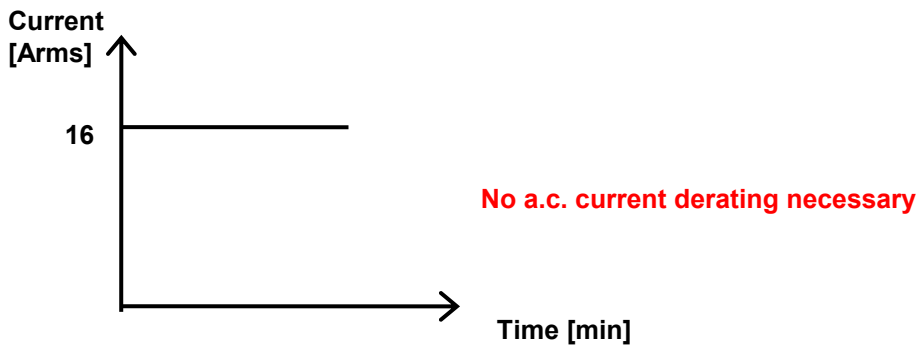

4.2.1.8 Internal Variac (55)

For the interruption and variation mode tests different voltages are needed. As standard the IMU4000 has an internal variac with a continuous current rating of 6 A. At shipment, two bridges are inserted (53) and (54). The variac is protected with its own fuses. For external variac operation, the two bridges must be removed, see Chapter 6 „Testing with the EXT- IMU4000 V“.

4.2.1.9 EUT Power 2 Inputs (48)

Input for the disturbance level during interruption. When an external source, e.g. external variac or an external ac/dc source (PS3), is used, the external source must be connected to these inputs (48).

Supply data a.c.: 20 to 250 V 16 A. no derating necessary

Supply data d.c.: 20 to 110 V 10 A. see derating below. Only applicable for IMU versions with EXT-TRA3000 ..D-V included.

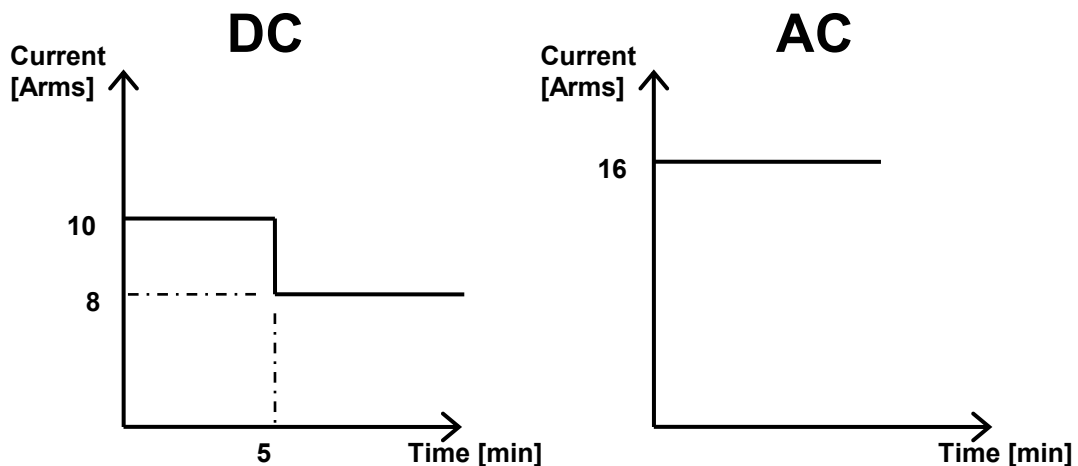

A temperature sensor protects the high voltage switch in case of d.c. supply.

4.2.1.10 Two interface „Port 2“ RS 485 for controlling external coupling networks or checking the EUT failed status (49,50)

Via this interface, the coupling path of external CDNs can be controlled. For further information, see the specific CDN or accessories manual.

4.2.1.11 Forced cooling of the IMU4000 (56)

A ventilator cools the IMU4000 internally. Forced cooling is necessary for the impulse forming network devices and the electronic high-voltage switch. A distance of about 20 cm must be maintained between the rear panel of the TRANSIENT 3000 and any wall, and about 3 cm between the sides of the IMU4000 and any equipment or wall. The IMU4000 can be built into a 19" rack, with 3 cm side separation.

4.2.1.12 Ethernet remote control (57)

The Ethernet interface port can be used to control the IMU4000 using an external PC with TEMA3000 program. To configure the interface, see Chapter 13 „Remote Control“.

4.2.1.13 Emergency stop, (EMERGENCY STOP) (58)

When the „emergency stop“ input is activated, the EMC test and the EUT power supply will be immediately interrupted. The power supply of the IMU4000 will not be turned off. The status „emergency stop“- will be indicated on the front panel. Emergency stop corresponds to 0V at the input.

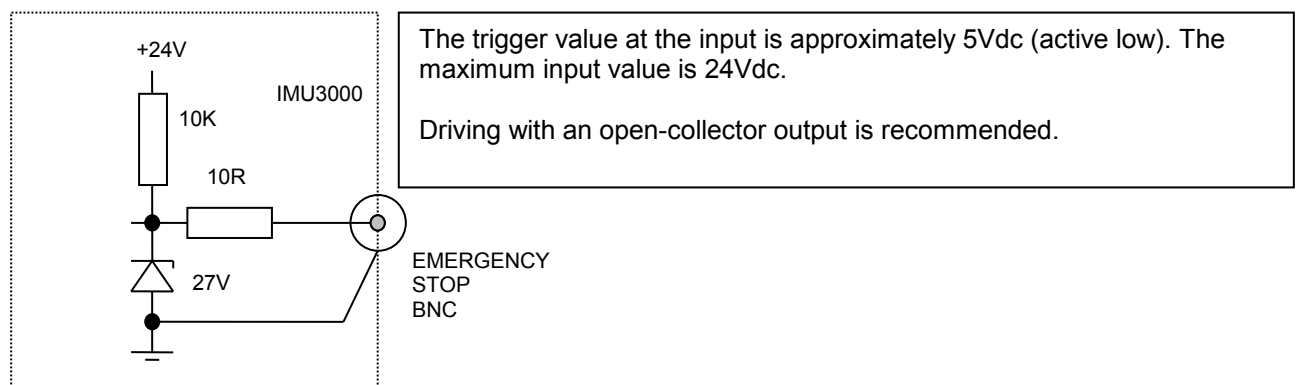

The trigger value at the input is approximately 5Vdc (active low). The maximum input value is 24Vdc.

Driving with an open-collector output is recommended.

4.2.1.14 Trigger input (59)

This input can be used for trigger the EMC pulses. The Trigger uses the negative slope of the Trigger signal.

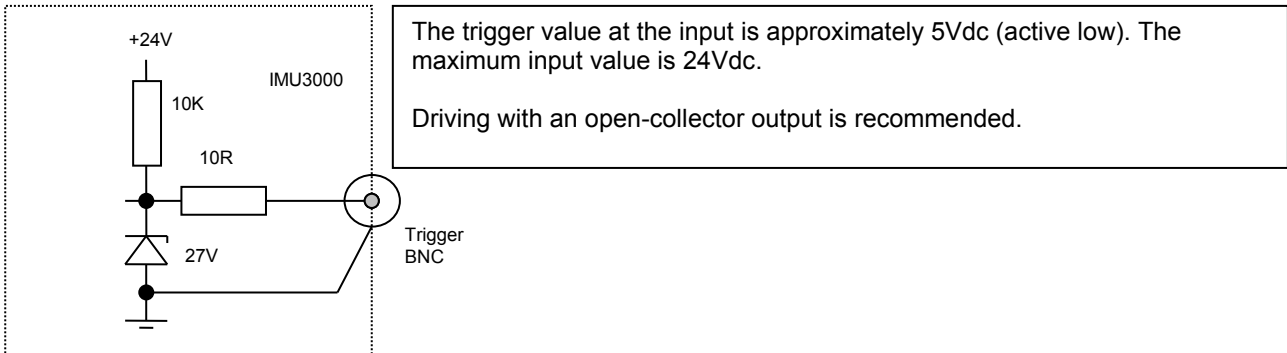

4.2.1.15 EUT Power 1 d.c. input (60)

For d.c. supply of the EUT the inputs (60) must be used. The EUT power 1 d.c. input is not protected by a fuse. The polarity + and – must be respected. The EUT power switch PWR1 operates only when the external d.c. supply is correctly connected to + and – inputs.
 Supply data: min. 20 to max. 300 V d.c. 10A. Only applicable for IMU versions with TRA-3000 ..D-V included.

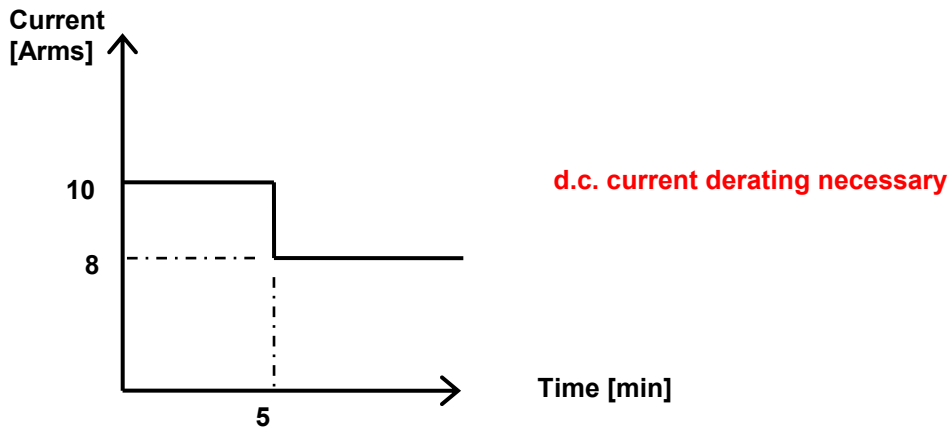

A temperature sensor protects the high voltage switch in case of d.c. supply.

Further information to d.c. dips and interruption IEC 61000-4-29 can be found in the Instruction sheets of:
 104124 EXT-TRA3000 D-29D
 104125 EXT-TRA3000 D-29I

5 Preparation for Operation

5.1 Attention, Refer to Manual

This manual is an integral part of the IMU4000 generators. The safety rules and precautions in the manual must be observed. EMC PARTNER and their representatives accept no responsibility for damages to persons and equipment as a results of non-observation of the safety rules and precautions in this manual.

Before connecting the IMU4000 generators to a public power line, Chapter 3 „Safety must be carefully studied.

5.2 Operators and Service Personnel

Only trained personnel should carry out EMC tests. For small groups of maximum 10 persons EMC PARTNER AG offers in-house seminars in English or German:

5.3 Checks before operation

5.3.1 Optical verification of the IMU4000 Generators

Before you unpack the IMU4000 Generator, please check whether the packing is deformed or damaged. When the IMU4000 is unpacked, also check whether the tester is damaged. If you detect damage, please inform EMC PARTNER and the SHIPPING ORGANISATION immediately.

5.3.2 Power source check

On the rear panel, you will find a type plate. Please check whether the Tester has been prepared for the correct power line voltage of your public power. If the power supply voltage is different please inform EMC PARTNER AG in Switzerland, or your EMC PARTNER AG representatives.

5.3.3 Connecting the IMU4000 Generator to the power line

Please use the supplied power cord for connecting the IMU4000 Generator to your public power supply. As stated on the rear panel, the power supply must have an earth safety wire. Please check the earth connection on your power outlet before you connect and turn on the IMU4000 generator.

5.3.4 EUT Power, Power source for the EUT

To connect the EUT Power 1 Input with the public power supply please cut the three black, blue and green/yellow cables supplied into two halves of the same length. One half used for the EUT Power 1 connection on the rear side of the IMU4000 Generator, and the other half for supplying the EUT from the front panel. The high inrush current during the DIPS test can only be reached, when the public power supply can deliver 500 A peak current. The public power supply must be protected by 16 A fuse.

Connection of the internal Variac:

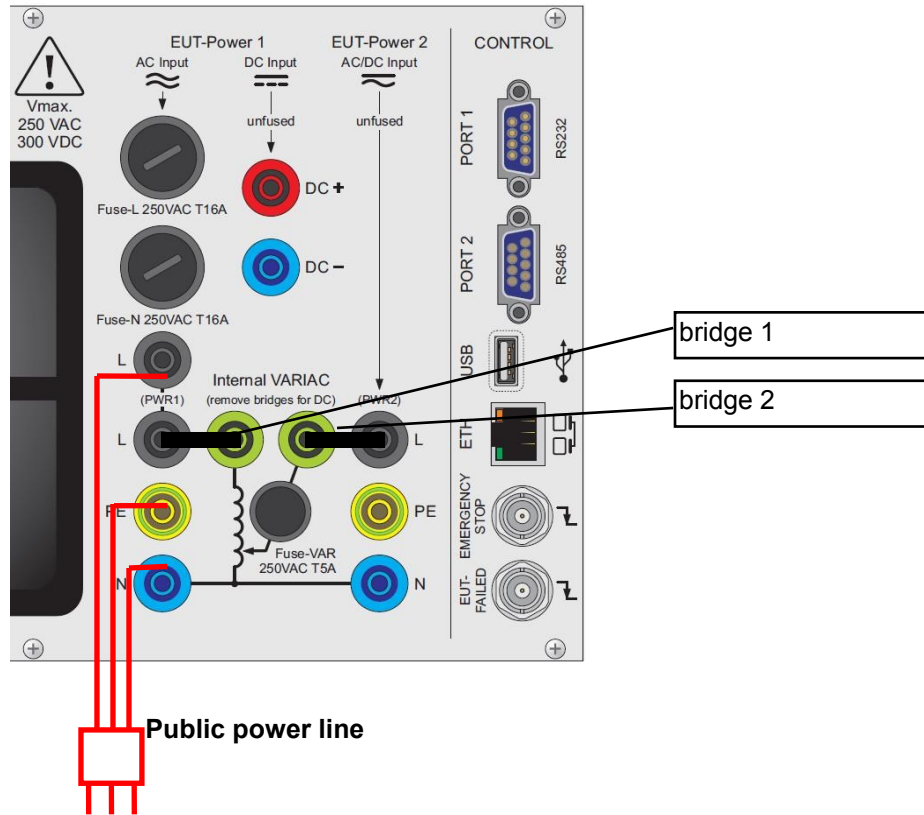

The Bridge 1 connects the internal variac with the public power supply on the primary side.

The Bridge 2 connects the secondary side of the variac to the EUT power 2 input.

Attention: Phase and neutral must be connected correctly. When the phase and the neutral are connected correctly, this is indicated on the front panel by a green LED.

	<p>Attention! If your power supply is equipped with fault current protective switch it may release when connecting the IMU4000 generator. A high current will flow to earth when Surges are superimposed between phase and earth. The impedance of 2 Ohm in series with 10 Ohm and 9 μF is a load on the power supply.</p>
---	--

Solutions:

1. For testing with IMU4000 generator use a power supply without a fault current protective switch.
2. Connect an insulation transformer between power supply and IMU4000 Generator. One secondary output terminal of the transformer must be grounded.

As a results of the leakage current always connect two earth leads to the IMU4000 generator.

5.3.5 EUT Power with voltages different from the public power line (Variac)

Internal Variac

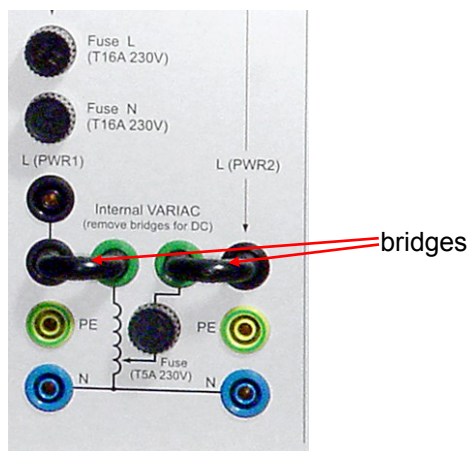

Both bridges must be placed as shown in the picture. EUT Power 1 must be connected to the 230 V public power supply.

Figure 5.3.5.1

Connection external Variac:

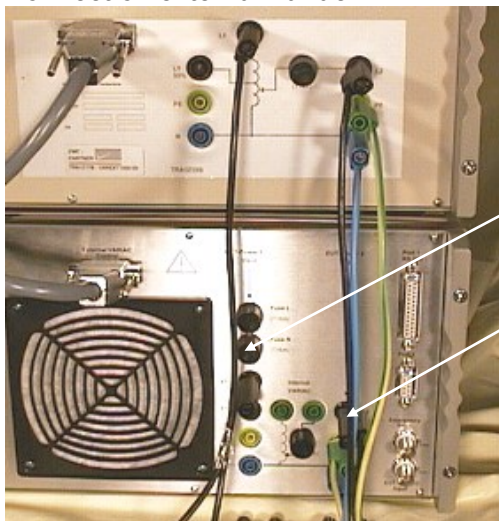

EUT
Power 1

The external Variac replaces the internal Variac.

Remove the two bridges.

EUT Power 1 (L1) of the IMU4000 must be connected with L1 of the external Variac. EUT Power 2 L, N, PE must be connected as shown on the picture.

EUT
Power 2

In addition connect the control cable between „External Variac Control“

Figure 5.3.5.2

Accessories delivered with the external Variac

- See VAREXT1000 user manual

5.4 EUT Power, supply of the EUT with dc

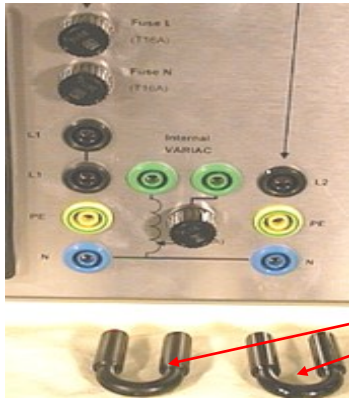

Caution!



Before a dc supply for the EUT can be used the two bridges must be removed.

If the bridges are not removed when the EUT is powered with dc the internal Variac will be heated and destroyed.

Figure 5.3.6

Preparations:

1. Remove the two bridges on the rear side of the IMU4000 Generator.
2. Connect the DC power supply with EUT - Power 1 d.c inputs. Connect the positive pin of the dc source with + input and the negative pin with - input.

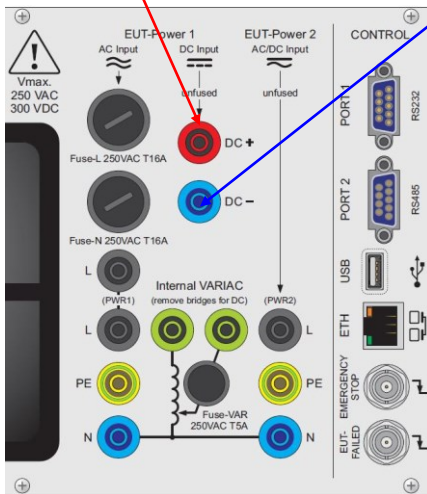

The IMU4000 can be equipped with different extensions, which results in different operation modes described below:

5.4.1 SURGE superimposing on dc

For this kind of test the dc voltage must be connected to input d.c EUT-Power 1 and the coupling path selected as in IEC 61000-4-5 ED3 defined.

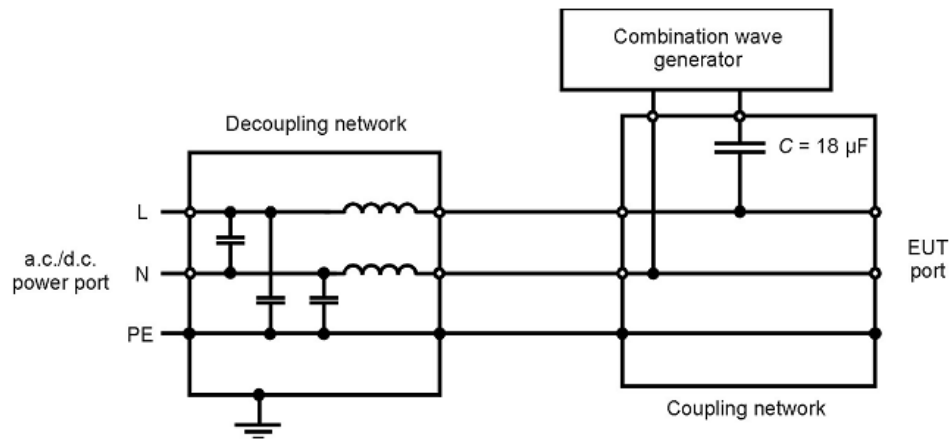

Figure 5 – Example of coupling network and decoupling network for capacitive coupling on a.c./d.c. lines; line-to-line coupling

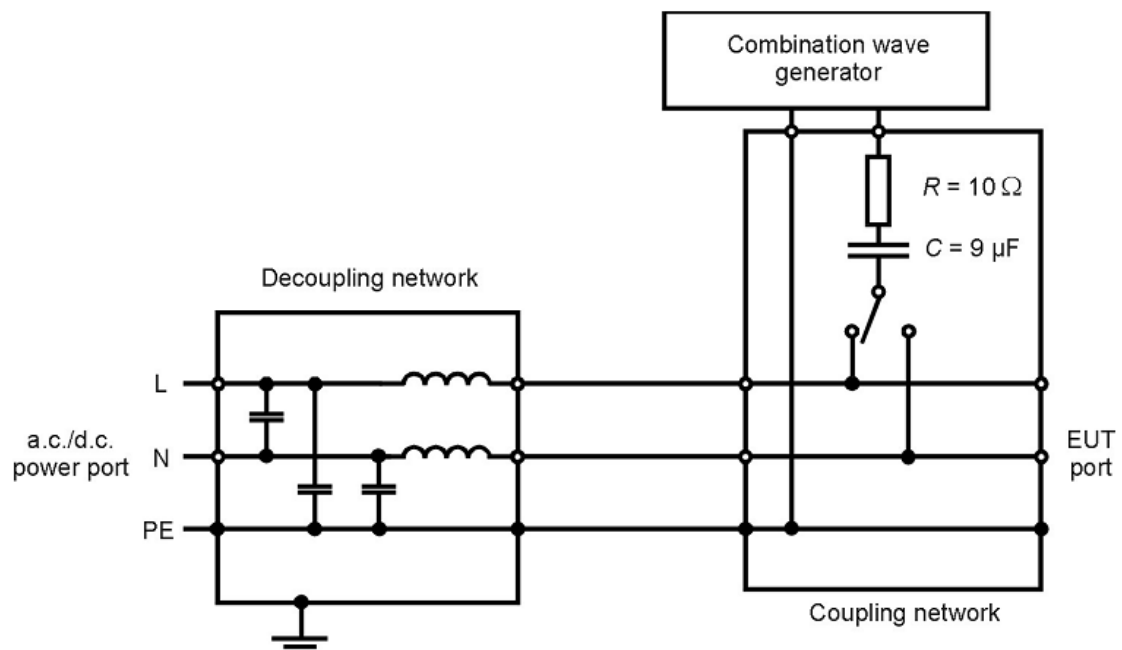

Figure 6 – Example of coupling network and decoupling network for capacitive coupling on a.c./d.c. lines; line-to-ground coupling

5.5 Hints for the test set up according to IEC standards

We list below those experiences of EMC PARTNER which are important for the success of the various tests. This information is only partly given in the standards.

Before a test is started, it is important to define which ports (inputs, outputs) must be tested. For the most important transient tests the ports are given as follows in the European generic standard:

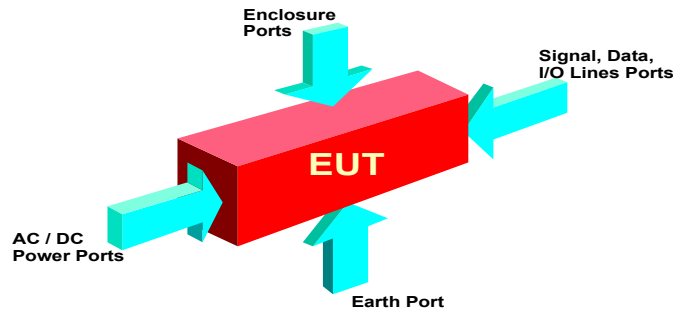

figure 5.4

5.5.1 Test set up EFT

Ports which must be tested:

AC/DC power supply, signal, data and I/O lines;

Coupling path:

For EFT pulses, the capacitive coupling is the dominant coupling path. The reasons why the capacitance coupling path play a dominant role are explained in the book „EMV Störfestigkeitsprüfungen“, published by FranzisVerlag Munich, or in the report „Schmalbandige Störfestigkeitsprüfungen im n-Sekunden Bereich“ by M. Lutz.

An example will show, that the impedance of EFT spikes at a capacitance of 100 pF (e.g. stray capacitance can be as high as 100 pF) is very low. As an approximation, the rise time of 5 ns can be converted into a frequency of 100 MHz, and the impedance can be calculated as:

$$Z = 1 / 2\pi f C = 1 / 6,28 \times 100 \times 10^6 \times 100 \times 10^{-9} = 15 \text{ m}\Omega$$

Test set-up:

As shown in the mathematical example, stray capacitance between coupling plate, tester, cables, laboratory wall and reference ground plates can have a large influence on the test results. Here are some hints for the set up of an EFT test:

- The tester must remain on the reference ground plane, and be connected to the reference ground plane by a low inductive connection.
- On table-top equipment tests, it is not clear from the existing IEC basic documents 61000-4-4 that the reference ground plane must be on the table, and not on the floor under the table. The EUT must be lifted 10 cm from the reference ground
- All cables must be placed in a reproducible manner. (We recommend a photo of the test set-up)

Safety:

The burst impulses described in the IEC standard 61000-4-4 are not dangerous to persons, because the energy and the pulse duration are too low. Testers are available on the market with higher spike frequencies and longer test duration, where the energy is much higher, and therefore more dangerous to persons.

As mentioned in Chapter 2, EFT disturbances can affect heart pacemakers or hearing aids.

5.5.3 Test set up SURGE

Ports which must be tested:

AC/DC power supply, signal, data and I/O lines; earth connections

Coupling path:

Unlike the EFT and ESD tests stray capacitance are not important here. The frequencies contained in the SURGE impulses are lower. The galvanic and mutual coupling are dominant. The cable lay-out and the test set-up is therefore uncritical. The test results are easily reproduced.

Test set-up:

What must be tested?

Protection circuit for inputs, and outputs as shown in the figure below.

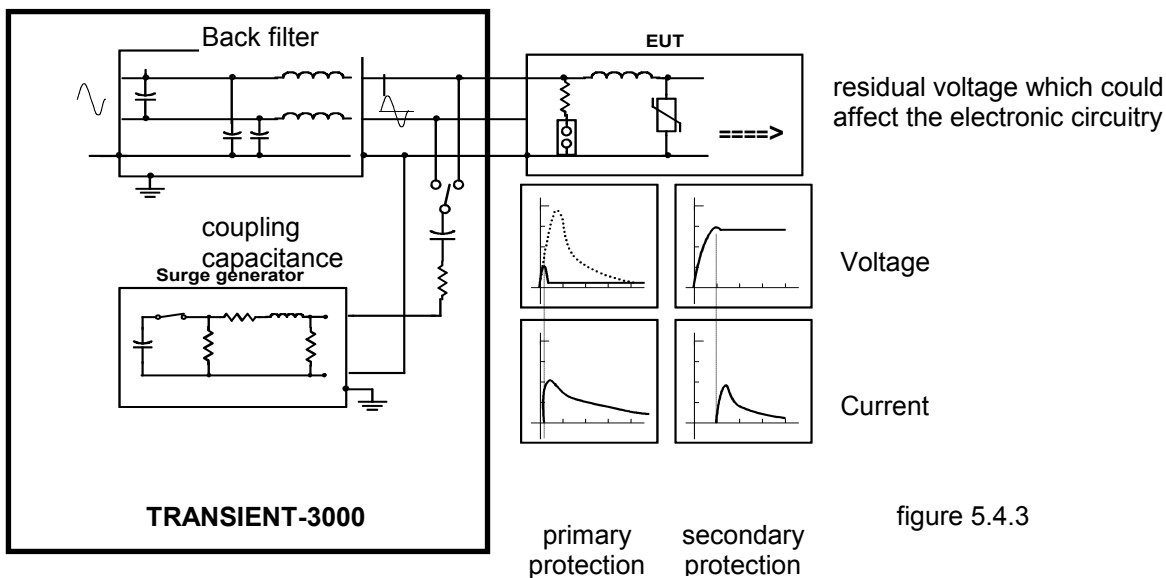

Superimposing SURGE pulses onto power lines is carried out using a capacitance between the tester and the power line. With the SURGE test, the effectiveness of the protection circuit will be tested. The residual voltage after the protection circuit could affect the electronic parts of the EUT.

The SURGE test is a single discharge, as for ESD. The considerations regarding single discharge which were made for the ESD discharge also apply here. Synchronisation with the power line frequency is important, and must be considered.

With the proposed current injection method, the bonding of screen and earth connections can be tested.



Safety:

The SURGE pulses can be dangerous for persons. The EUT and its cables should not be touched during SURGE EMC tests.

In case of a breakdown in the EUT, it must be remembered that high currents can flow from the power supply.

Test set up DIPS, Interruption

Ports which must be tested:

AC / DC power supply

Coupling path:

These disturbances appear on the power lines. Disturbance sources are short circuits between power lines, power line switching actions and heavy load changes etc.

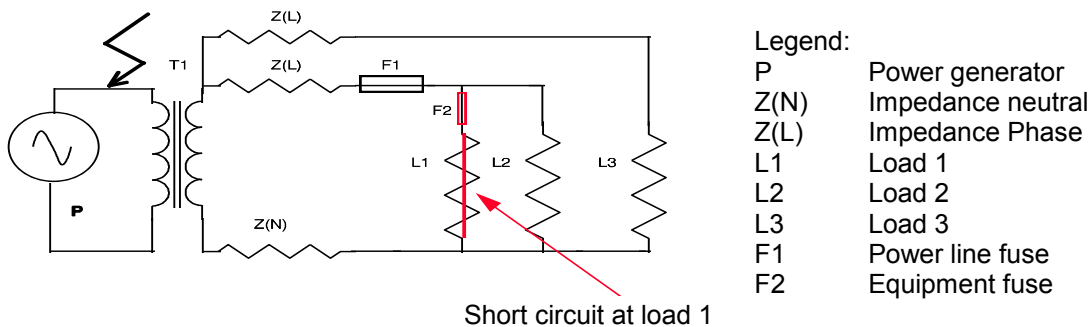

figure 5.4.4.1

Test set-up:

- During DIPS test remember that high inrush currents are possible during the turn on phase of the DIPS.
- With switched power supplies the current can increase linearly with the voltage reduction e.g. I= 1A at U 230V, and with reduced voltage of U = 40%, the current increases to 2,5 A.
- For a realistic DIPS and interruption test, the test object must be discharged using the power line impedance, see Chapter 3.4.

Test levels, Voltage interruption

Test Level % U_T	Voltage Dip/int % U_T	Duration (in period)
0	100	0.5* 5 10 25 50 x
40	60	
70	30	

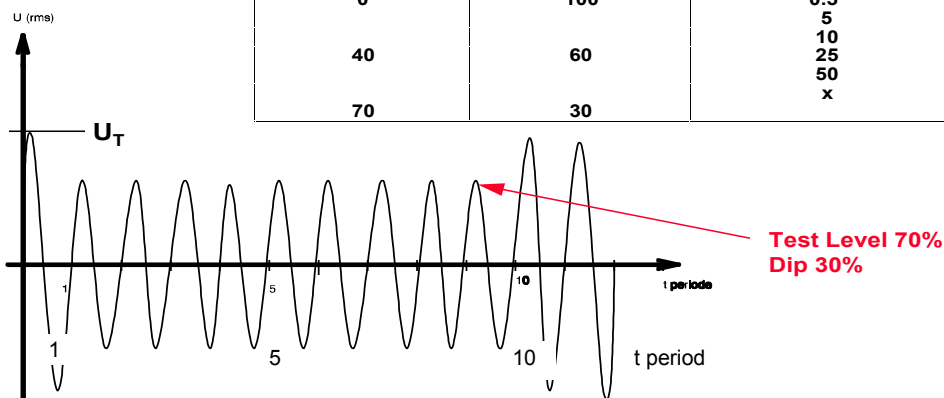

figure 5.4.4.2

Begin of the interruption

End of the interruption

5.5.4 Test set-up for table top equipment

Test set up

Single Phase EUT

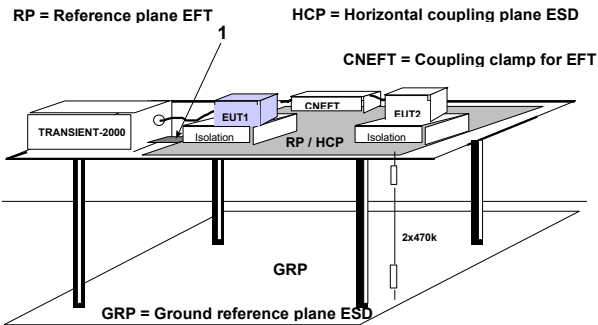

Three Phase EUT

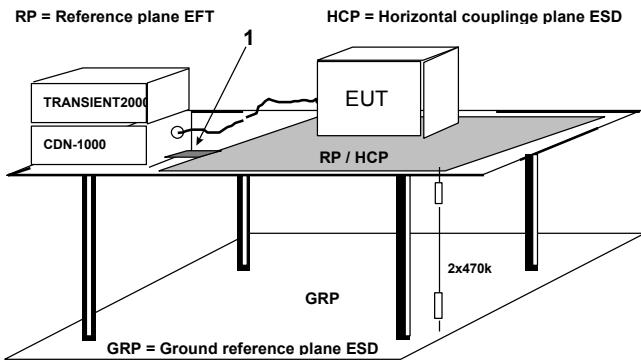

Combination: Immunity and Emission

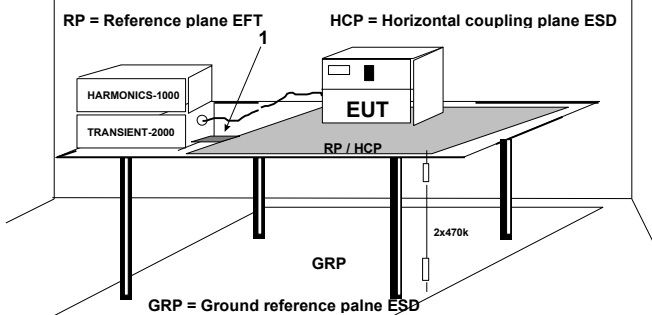

Test sequence

I. EFT

1. Connect the earth bar of the IMU4000 with the flat multiwire cable (1) to the reference ground plate
2. Put 10 cm insulation between EUT and the reference ground plate
3. Carry out the tests!

II. ESD

1. Remove the flat multiwire cable (1) between the earth bar of the IMU4000 and the reference ground plate
2. Put 0,5 mm insulation between EUT and the reference ground plate
3. Carry out the tests!

III. SURGE, DIPS, VARIATION

1. Reinstall the flat multiwire cable 1
2. Carry out the tests!

I. EFT

1. As for single phase EUT
2. As for single phase EUT
3. Connect the Impulse out of the TRANSIENT with EFT coupling on the threephase Coupling/De-coupling network CDN-2000-06-32
4. Carry out the tests!

II. ESD

1. As for single phase EUT
2. As for single phase EUT
3. Carry out the tests!

III. SURGE,

1. Make connection 1
2. Connect the surged phase for synchronisation with EUT Power 1
3. Carry out the tests!

IV. DIPS Interruption

1. Loop the phase for dips and interruption through the IMU4000 (EUT Power 1)
2. Carry out the tests!

I. IMU4000 Tests:

1. Carry out the tests as explained for single and three phase EUT

II. HARMONICS-1000-Measurements

1. Harmonics in accordance with IEC 61000-3-2
2. Flicker in accordance with IEC 61000-3-3
3. Immunity Harmonics IEC 61000-4-13

For brochures and further information about HARMONICS-1000 contact EMC PARTNER AG or your nearest representative.

5.6 Practical testing sequence

In practice, the following test procedures has been shown to be reliable:

1. Burst-Testing:

- **Burst-testing** on mains inputs with a test voltage of 4kV
- **Burst-testing** of signal and data lines up to 4kV

The energy contained in the burst pulses is relatively small, thereby minimising damage to the test object. The higher the repetition frequency, the more likely that weak points become evident in the test object.

2. ESD-Testing:

With this test, effects induced through the keys and the housing of electronic equipment can be simulated.

Metallic parts, contacted method up to 8 kV

- Insulated parts, air discharge up to 15 kV

In practice, an item that has undergone burst testing shows a better immunity to ESD, than one which has not. Likewise, an item that has undergone burst testing shows a better immunity to current injection or cw field tests.

3. Surge-testing:

- **Surge testing** mains up to 2 kV

This should be used to test input protection elements and protection circuits installed in electronic equipment. The energy content is very high in the surge test, and can destroy elements in the EUT.

- **Surge testing** signal and data lines up to 1 kV

4. Mains simulation:

As a consequence of the increasing number of non-linear loads, the quality of the mains gets worse and worse. To be sure that electronic equipment can withstand the mains interference, test are such as:

Mains interruption, Mains under and over voltage variation, harmonics simulation etc. are required.

5. Further testing:

For most EUTs, the described transient tests are sufficient. Further testing of the product to determine differences, e.g. with regards to the effects of magnetic field on monitors or on protection elements, may be needed.

Conclusion:

The product determines which kind of EMC test must be applied. It is also important, that EMC testing should only be carried out by trained personnel, with a knowledge of how the test object should function, and some knowledge of transients and EMC. The four tests, with their range of impulse types, simulate only single signals, and do not cover the complete range of EMP phenomena. However, if no more failures were registered, after a period of EMC testing with electronic equipment and systems in practical operation, it would not be justified to impose additional EMC tests.

Further EMC test information can be obtained from EMC Partner or from our representatives.

6 Testing with the IMU4000

6.1 Operation of the tester via touch screen monitor

Only when Chapter 2 „Safety“ and Chapter 5 „Preparation for operation“ and all instructions have been followed the IMU4000 can be operated.

To start the control, tester, the following steps must be carried out:

- Turn the power switch on the rear side to position I
- Operate the ON/STBY button on the front panel the display turns to:

6.1.1 General information about the touch screen monitor

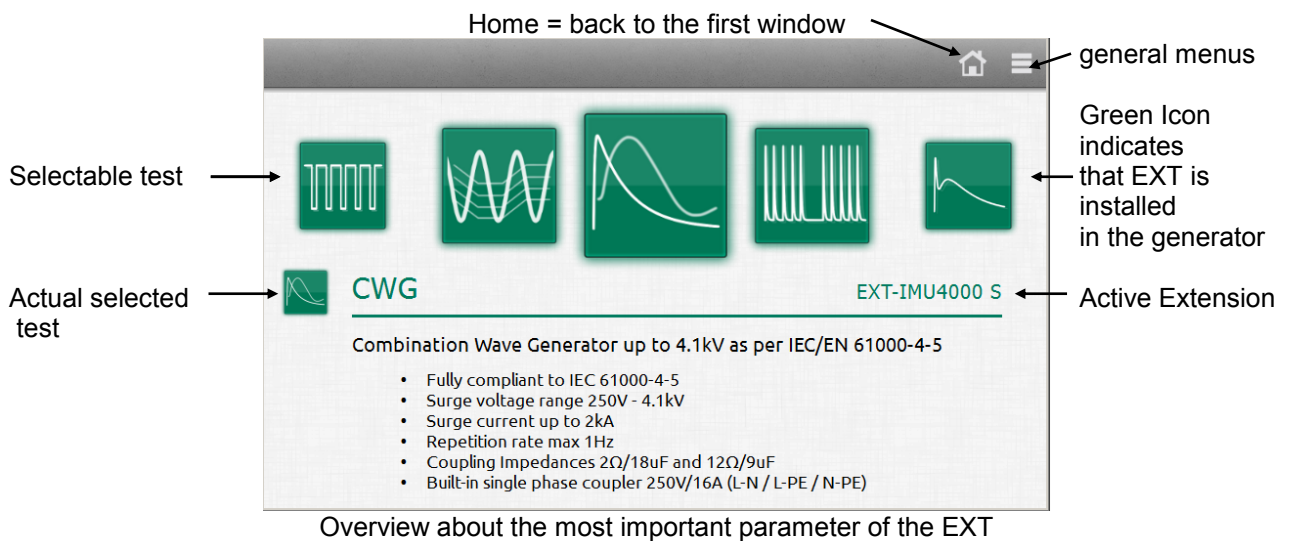

6.1.2 Selecting the parameter – Example CWG

The test can be selected by scrolling with a finger on the touch panel or using the rotary knob. When the green icon is in the centre of the windows click on it and the CWG windows will be shown

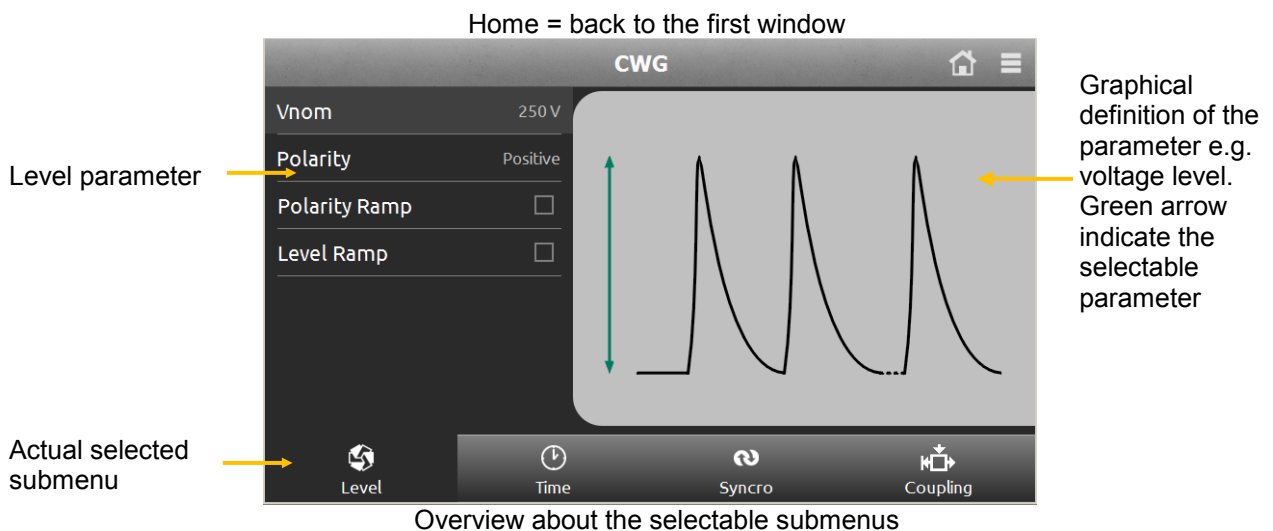

By touching or clicking twice on Vnom the following windows will be shown



Level Vnom selected

Numerical input terminal for selecting the voltage level.

The level can also be selected with the rotary knob beside the monitor.

Actual selected submenu

with o.k. the selected value will be stored and the windows will be closed

Additional help can be activated by holding the finger on one line for 2 to 5 seconds e.g. Vnom

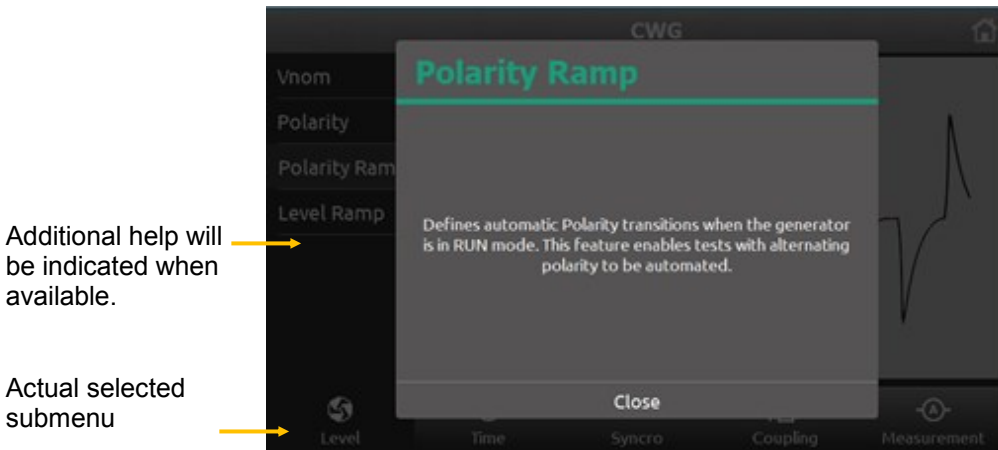

Additional help will be indicated when available.

Actual selected submenu

Using the same procedure Polarity, Polarity ramp and Level ramp can be selected. Combination of ramps are possible except with V-ramps. When a V-ramps and a polarity ramp are selected a red warning will occur. One of the parameters is highlighted in red and will be deactivated.

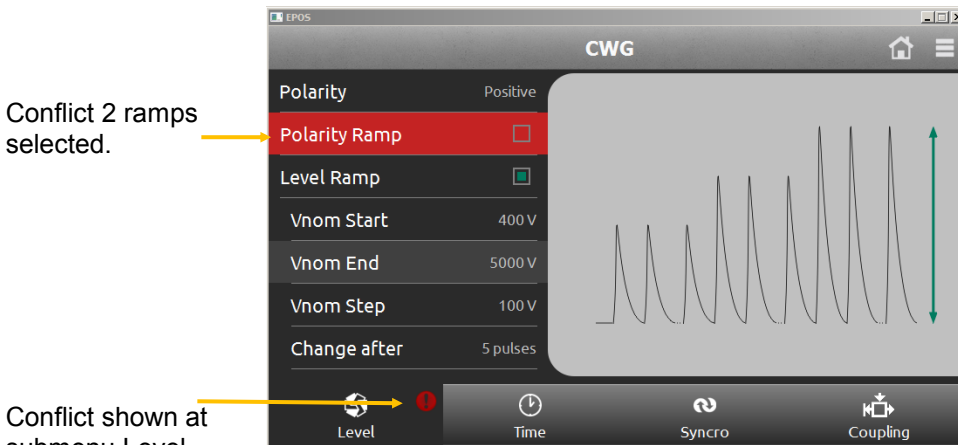

Conflict 2 ramps selected.

Conflict shown at submenu Level

Another example of a conflict between the selected voltage and the repetition.

The screenshot shows the CWG menu with the following settings: Number of pulses: 1000, Repetition: 12 s, Trigger Mode: Automatic. A waveform graph shows three pulses with a green double-headed arrow indicating the repetition interval. The bottom navigation bar includes Level, Time, Syncro, and Coupling.

Conflict the repetition was too fast for the selected Vnom 12s is O.K.

Conflict is in submenu Time

The repetition will automatically be set to 12s for a voltage of 8000 V

The parameter values can only be selected within the range given. If values are chosen that are above or below the given range the maximum or minimum value will be set automatically.

Sub menu time for CWG

The screenshot shows the CWG menu with Trigger Mode set to Manual. A stick figure icon is shown interacting with a control panel diagram. The bottom navigation bar includes Level, Time, Syncro, and Coupling.

Trigger mode

Submenu Time

The figure shows what trigger mode is selected Manual or AUTO

Using the same procedure Number of pulses, Repetition and Trigger mode can also be defined.

Sub menu Synchro for CWG

The screenshot shows the CWG menu with the following settings: Mode: EUT-Power, Degree: 0°, Syncro Ramp: . A waveform graph shows a sine wave with a green box labeled 'SYNC' around it. The bottom navigation bar includes Level, Time, Syncro, and Coupling.

The following mode can be selected: No Synchro Impulse out EUT Power or External

Submenu Synchro

Example: Synchronisation will be on EUT power. Additionally synch angle and ramp can be defined

Sub menu coupling for CWG

All devices in the list can be selected

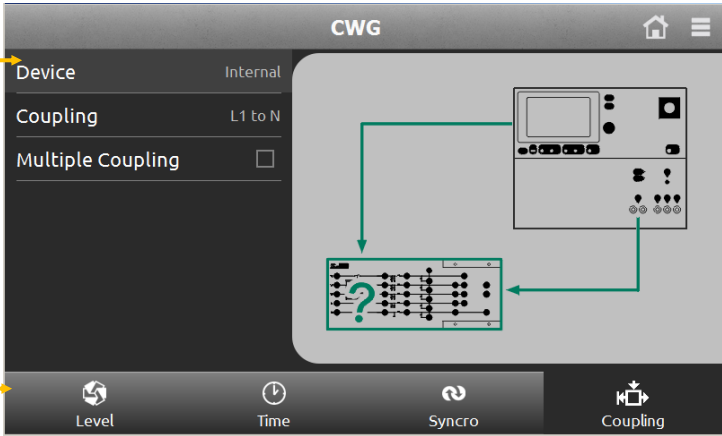

Standard accessories from TRA Tester can be used. When the correct device (CDN) is selected the voltage of the IMU4000 will be limited

Submenu coupling

Sub menu coupling for CWG

The listed coupling modes can be selected

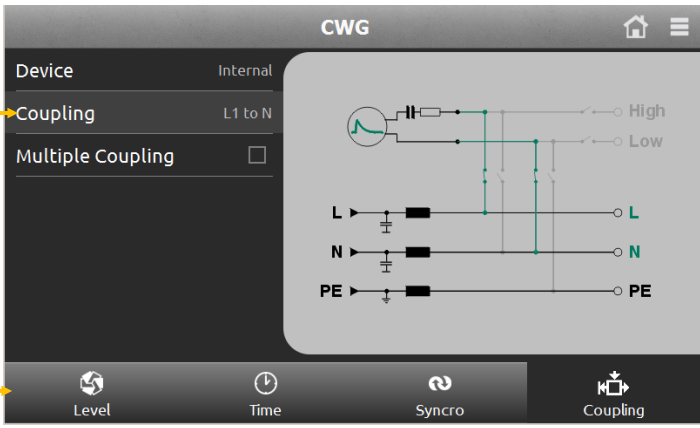

Green indicates the selected coupling path

Submenu coupling

Sub menu coupling for CWG

All coupling path listed in IEC 61000-4-5 Ed.3 and the number of impulses per path can be selected

The double level for coupling to PE can be selected

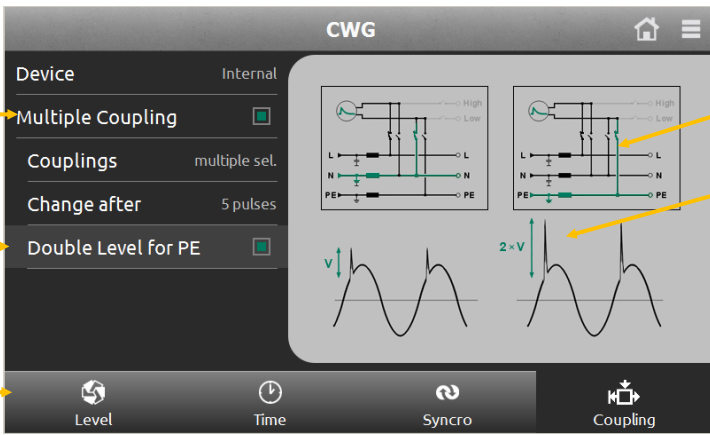

Green indicates the coupling and the related voltage level automatically selected. Also the coupling impedance will change automatically.

Submenu coupling

All other tests can be started and carried out in the same way. All test can be started or stopped with the "RUN" or "STOP" button.

6.2 The general menu

General menus

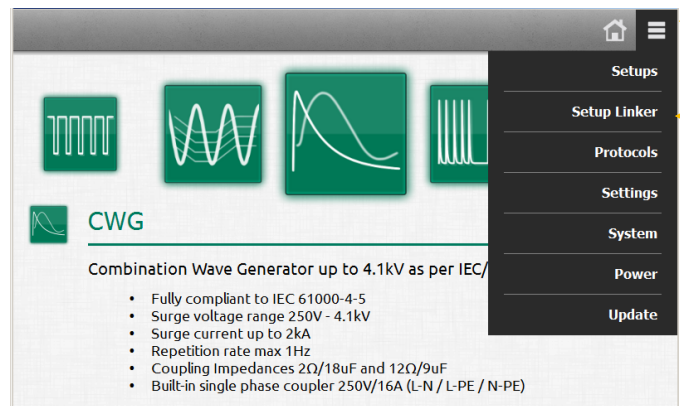

General menu pull down windows

Touching a line will open an additional windows

The parameters in the additional windows are valid for all tests

6.2.1 General menu "Setups"

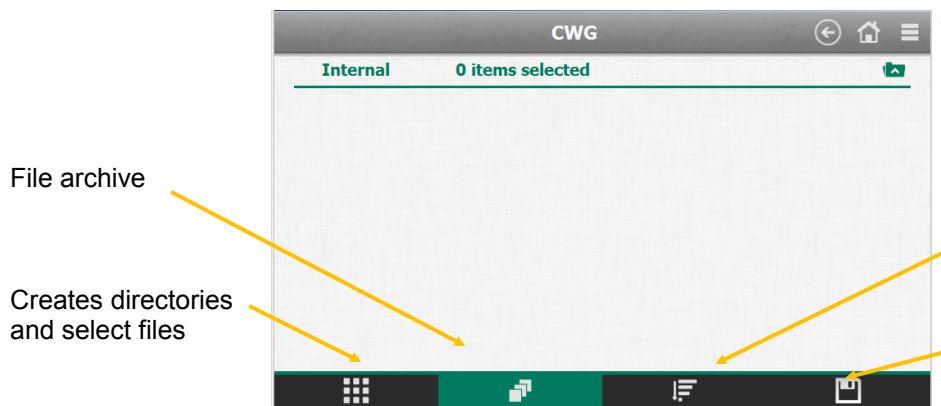

File archive

Creates directories and select files

General menu pull down windows

Sort the files in function of name, date and type

Activate and save tests

6.2.2 General menu "Setup Linker"

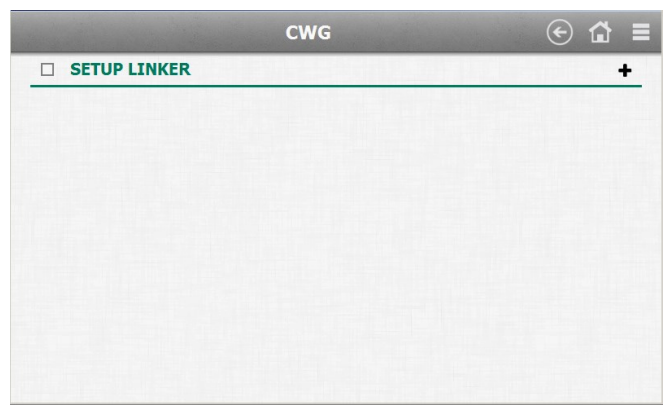

General menu pull down windows

Up to 15 test can be linked together

6.2.3 General menu "Protocols"

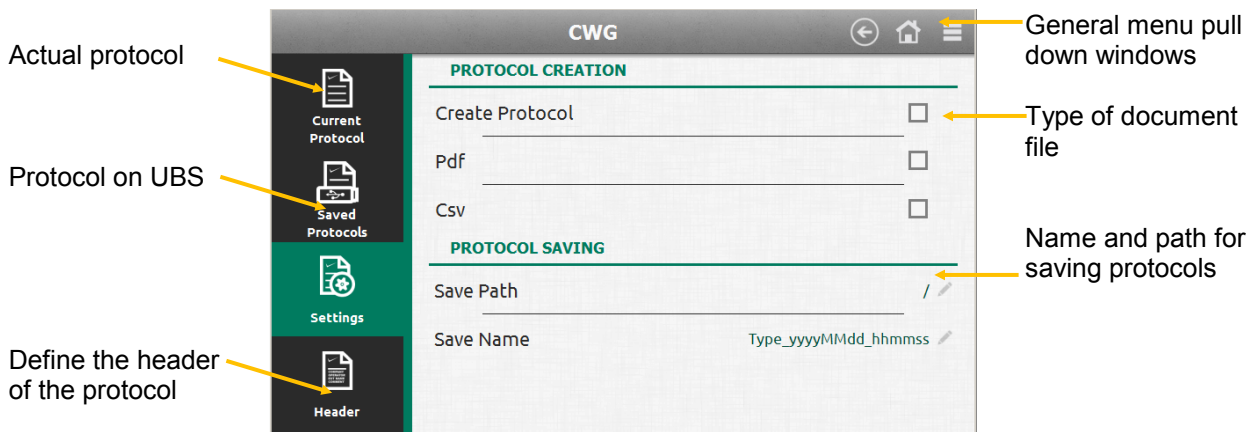

The IMU4000 control can create a protocol and convert it into pdf or Csv files. The files can be stored onto the UBS stick and from the UBS stick the protocol can be printed from a PC.

USB stick

1. Insert on the front panel a USB stick.
2. Select save protocol
3. Transfer the file with the USB Stick to a PC
4. Print the protocol from the PC

6.2.4 General menu “Settings”

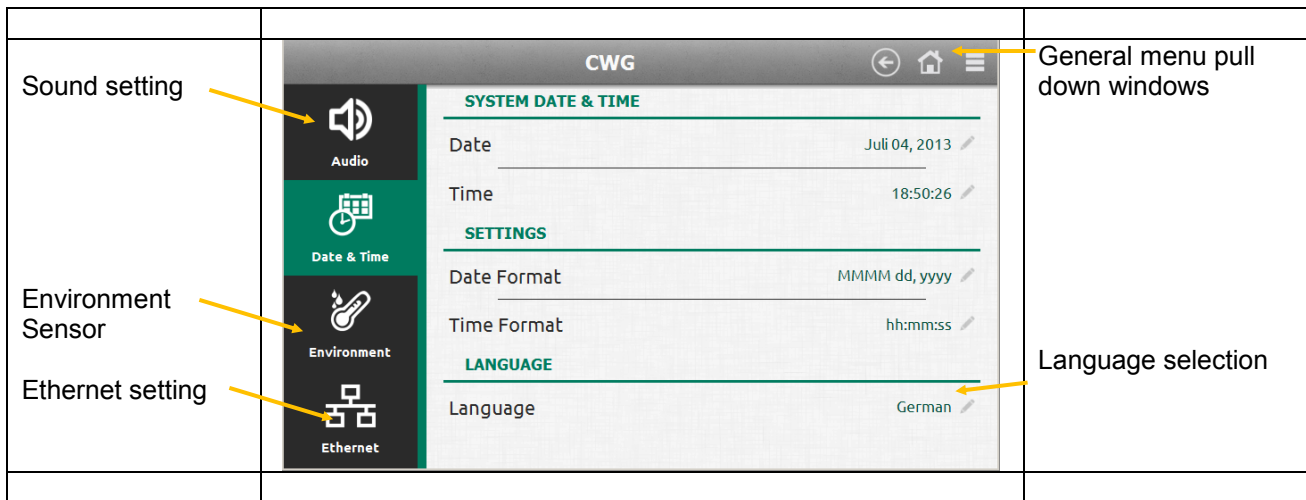

One of the great advantages of the IMU4000 Generator is the language selection. The equipment is shipped with English language selected. To change the language select date and time and the desired language from the list.

6.2.5 General menu “System”

SN Generator, Type and Software Version

SN Extensions Hardware EXT configuration

Customer list of available accessories

System reset System configuration

General menu pull down windows

SYSTEM INFO	
Generator	IMU3000
Serial Number	0
Target	CUPID
EMCP OPERATING SYSTEM	
EPOS Version	undefined
EPOS Revision	undefined

6.2.6 General menu “Power”

Selection of possible power supplies

General menu pull down windows

POWER	
Power State	Off
MEASUREMENTS	
Pwr1	0 V / 0 Hz
Pwr2	0 V / 0 Hz
EUT Power	0 V / 0 A / 0 Hz
CRO	
EUT-POWER ratio	U-CRO: 1V = 0V, I-CRO: 1V = 0A

6.2.7 EUT - Power and EUT - Control

For running the interruption, voltage variation and DIPS, the EUT PWR1 Input on the rear side of the IMU4000 Generator must be connected to the mains. Please check that the L and N as written on the front panel correspond with the phase and neutral of the mains.

Variac voltage:

When the variac with button PWR2 is activated the output voltage can be changed directly by editing the output voltage. Online the power voltage is measured and indicated on top of the display.

Current Lim.:

When the EUT supply current will reach the selected limit the test will be stopped and the EUT power will be turned OFF. The current limiter can be used for automated test during night etc. The reaction time of the limiter is several 100 ms. During a variac regulation, or while printing a report the current limiter is inactive.

6.2.8 General menu “Update”

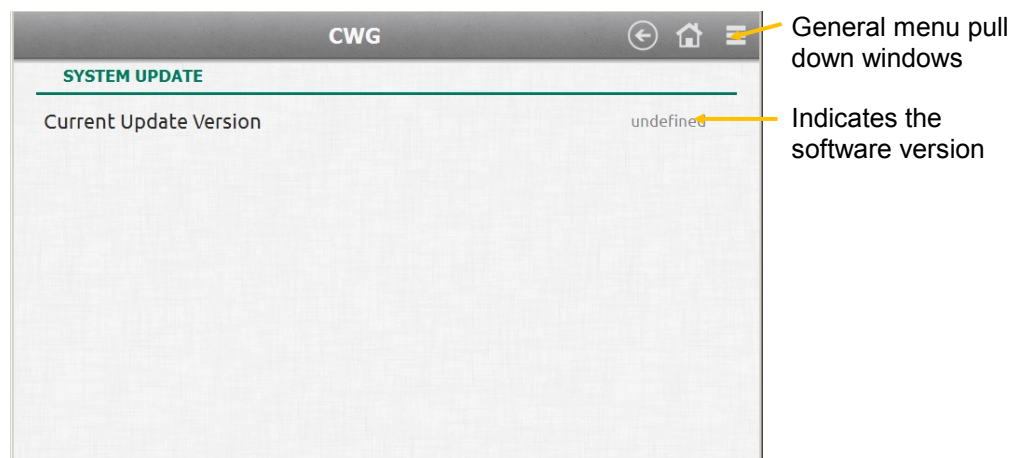

6.3 EMC test operation „RUN Mode“

Before you start an EMC test, you should be familiar with the following:

„**Run Mode**“ is defined as an EMC test operation such as EFT, ESD etc. The „Run Mode“ is indicated by the LED on the operation panel of the front. Pressing the RUN-button sets the IMU4000 Generator into the RUN mode. During RUN Mode, the corresponding test-LED on the operation part lights and the corresponding coupling path is illuminated.

Pressing of the STOP button stops the generator (Reset to the standby mode).

In „**Standby Mode**“ the power to the TRANSIENT is switched on. The control is activated. No high voltage source is switched on.

Depending on local safety standards, an emergency stop must be installed. All operators and laboratory personnel must be able to reach the emergency stop. On the rear side of the IMU4000 Generator there is an **EMERGENCY STOP** input. See Chapter 5 „Preparation for Operation“.

Trigger.

After the RUN button has been pressed, the tester is started, but not the EMC test. As soon as the generator is ready (e. g., the impulse capacitor is charged), the LED on the trigger button is illuminated. A single EMC test can be initiated (Burst, ESD, DIP, Variation) either automatically or manually by pressing the “Trigger” button. The next trigger can take place when the LED is illuminated again.

During ESD, the trigger button has the same function as the button on the ESD discharge network.

6.3.1 Example CWG operation

Under consideration

In RUN-mode, most of the parameters can be continuously varied using the „+“ and „-“ buttons. This is very helpful for exactly determining of the immunity level of the EUT. The manual change of the nominal voltage will be noted in the report with a warning.

If ramp has been chosen, the different values will change as follows:

Voltage ramp	V-peak	V
Frequency ramp	Freq.	kHz
Burst duration	Burst	Dur
Synchronisation	Synchro	°

For very fast investigation the coupling paths can also be changed during operation by pressing the N, PE, L buttons

6.3.2 Web Server

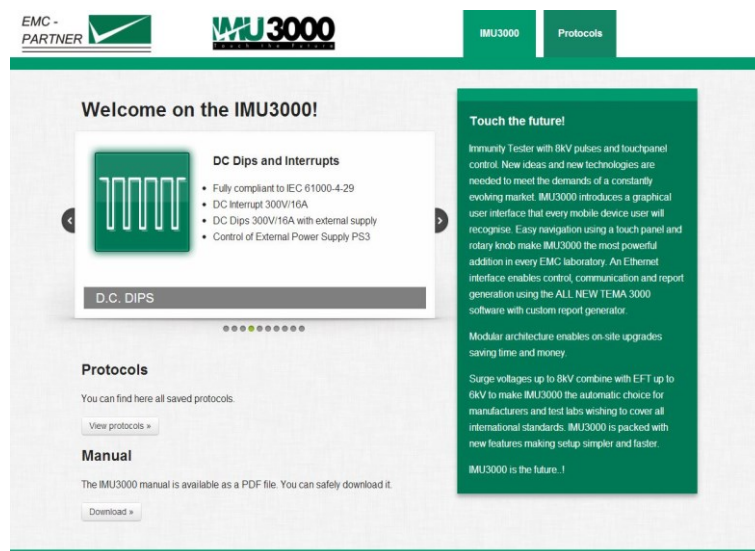

7 Maintenance and Servicing

7.1 Maintenance

To avoid electrical shock, be sure that the power cord is disconnected before starting maintenance work. EMC PARTNER recommends that the air filter of the ventilator be cleaned from time to time. The cleaning cycle depends on the environmental conditions. Place the air filter of the ventilator in soapy water for 15 minutes. After 15 minutes, the air filter must be dried before being reinstalled.

If the DIPS and Variation circuit is used very often with high current, the VARIAC brushes must be changed.

No further maintenance is necessary on the IMU4000.

7.2 Cleaning front and rearplate

The cleaning of the front-, rear- and type plate can be made with warm soapy water and a cleaning tissues. The display can be cleaned with a cleaning tissues.

7.3 Verification versus Calibration

7.3.1 Verification Example IEC 61000-4-4 Ed.2

Set of operations which is used to check the test equipment system (e.g. the test generator and the interconnecting cables) and to demonstrate that the test system is functioning within the specification given in Clause 6

✉ Note 1 the method used for verification may be different from those used for calibration

✉ Note2 The procedure of 6.1.2 and 6.2.2 is meant as a guide to insure the correct operation of the test generator, and other items making up the test set-up so that the indeed waveform is delivered to the EUT Customer has to do it before a series of tests starts

7.3.2 Calibration Example IEC 61000-4-4 Ed.2

Set of operation which establishes, by references to standards, the relationship which exists under specific conditions, between an indication and a result of a measurement.

✉ note 1 This terms is based on the “uncertainty” approach

✉ Note2 the relationship between the indications and the results of measurements can be expressed, in principle, by a calibration diagram.

7.4 Verification of the IMU4000 by the user

A verification whether high voltage pulses occur at the tester outputs can be carried out using an oscilloscope of a bandwidth of 20 MHz.

7.4.1 EFT

1. Setting EFT Test „Main Menu“

V = 500 V; f = 100 kHz; Burst duration 10ms; Coupling path N-PE

2. Measuring points:

With 10x probe at banana plug output marked N, connect ground to the earth terminal rail

3. Settings at the oscilloscope

Time base 10 to 50 ms,

Vertical deflection 5 V / division

On the CRO screen, the Burst must be visible. The single spike is not visible because the bandwidth is insufficient.

7.4.2 ESD

1. Select 8 kV charging voltage and repetitions frequency 1Hz
2. Discharge to a ground plate. A spark of approximately 3 mm length must be visible.

7.4.3 SURGE

Verification as specified in the Basic Standard 1000-4-5.

- Measurement of output voltage at no load
- Measurement of short circuit current with short circuit output
- Check that voltage and current waveforms are within the tolerances.
- Calculate the source impedance from the peak voltage divided by the peak current.

1. Setting SURGE Test „Main Menu“

V = 1000 V; repetition 5s; coupling path L-N,

Attention!! The power cord must be removed from the inputs EUT Power 1 and 2 of the rear side.

2. Measuring points:

SURGE U-CRO for the voltage measurement at no load

SURGE I-CRO for current measurement at short circuit (make a short circuit on the front panel of the IMU4000 using a banana plug type cable 1000 between L-N)

3. Setting measuring equipment

Time base 5 μ s,

Vertical deflection 0.5 V / division

Definition of the wave-forms and their tolerances, see Chapter 14.1

7.4.4 Interruption

Verification as specified in the Basic Standard 61000-4-11.

Trigger the measuring equipment via the external trigger input. Different trigger level, see Chapter 1.2.7

7.4.5 Variation

1. Setting IMU4000 Setup Var 2s1s2s

2. Measuring point:

BNC output EUT Power U.

3. Setting measuring equipment

Time base 10 to 50 ms,

Vertical deflection 2 V / division

The voltage variation can be measured with the oscilloscope.

7.5 Calibration of the IMU4000 by EMC PARTNER AG

EMC PARTNER calibrate every EXT-IMU4000 in accordance with the calibration chapter within the Basic Standards. Before a IMU4000 is delivered, calibrations are carried out in accordance with the basic documents.

All data are within the tolerable tolerances.

See calibration report EXT-IMU4000 delivered with the generator or EXT-TRA3000.

Demand a quote for calibration

EMC PARTNER recommend a calibration of the EXT-IMU4000 every **two years**.
All calibration reports include detailed measurement data including oscillogramms.

A calibration without a repair takes approximately 3 days.

7.6 Service of SPD Surge Protective device

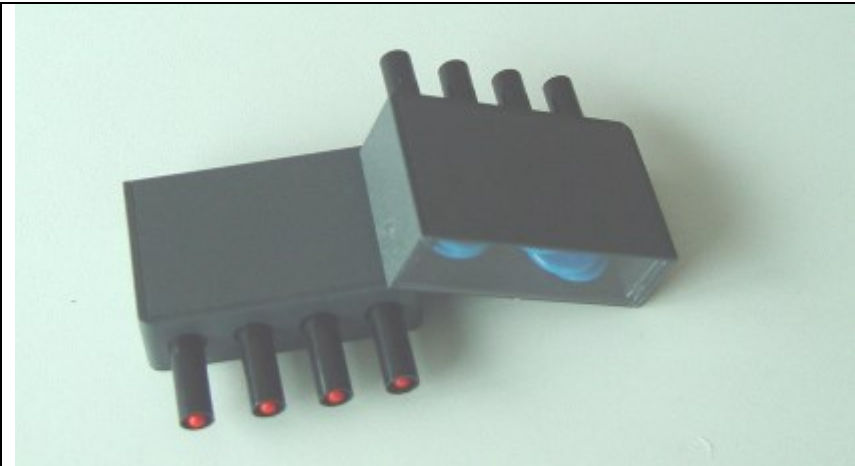
	<p>VAR BOX Art Nr 104387</p>
<p>Box with varistors 300V S20K300 to TRA3000</p>	

The VAR BOX protects the TRA3000, when too high power supply voltage is applied to the EUT power input or the TRA3000 power output to the EUT or when the EUT generates a too high surge voltage.

Customers can change the varistor box by removing the TRA3000 top cover.

8 What must be done following failed operation

The IMU4000 generators have many different messages to assist the operator solving possible problems, give information regarding incorrect operation of the IMU4000-generator, or to correct an incorrect system configuration.

8.1 Service; Repairs

The IMU4000 is a compact equipment for service the different EXT-TRA3000 or IMU4000 modules can be interchanged by the customer or by EMC PARTNER authorised service companies.

List of EXT-TRA3000 for IMU4000 generators:

PN	Type
104023	EXT-TRA3000 E
104025	EXT-TRA3000 V
104026	EXT-TRA3000 D
104028	EXT-TRA3000 C
104123	EXT-TRA3000 C-SHORT
104124	EXT-TRA3000 D-29D
104125	EXT-TRA3000 D-29I

List of EXT-IMU4000 for IMU4000 generators 6 kV versions:

PN	Type
106896	EXT-IMU4000 F
106897	EXT-IMU4000 S
106898	EXT-IMU4000 F5

8.1.1 Service Flowchart of IMU4000 System:

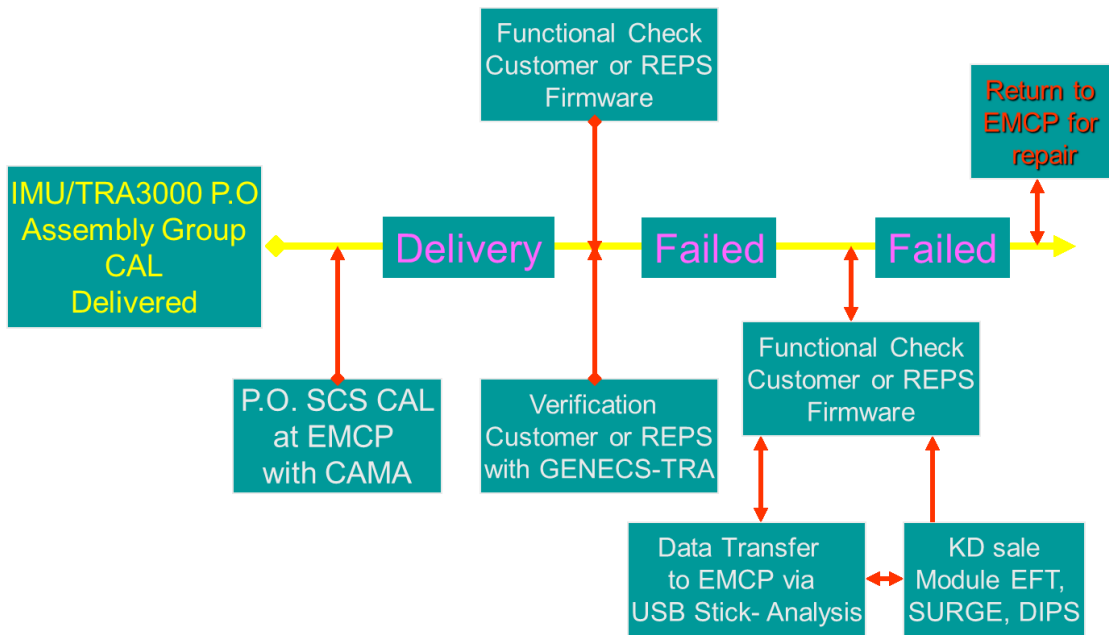

8.1.2 Data Transfer via UBS Stick

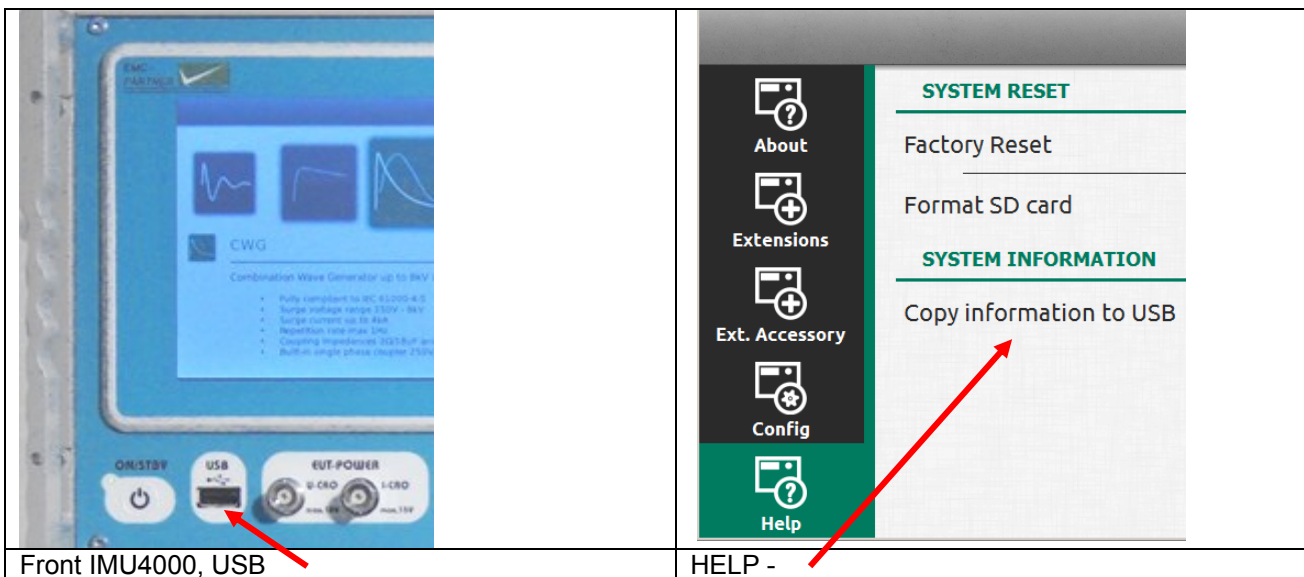

- Step 1: Insert the USB stick
- Step 2: Select Service menu
- Step 3: Store the data on the USB stick
- Step 4: Send the data par email to EMC Partner

8.2 Spare parts list

No spare parts are necessary for the IMU4000.

8.3 Check before you contact the service of EMCP

8.3.1 Fuses

Always check the fuses of the unit before you contact EMCP service. A set of fuses has been delivered with the tester.

8.4 Service department of EMC PARTNER AG

EMC PARTNER AG
Baselstrasse 160
CH - 4242 Laufen
Switzerland
Tel. ++41 61 775 20 50
Fax ++41 61 775 20 59
Email service@emc-partner.ch
Web www.emc-partner.com

9 Packaging and Transport

9.1 Packaging

If you transport the IMU4000, pack it in the original shipping box and packing material.



ATTENTION!

Before shipping make sure IMU4000, is correct way up and that the shipping box is marked with arrows and or text "THIS WAY UP".

Fitting a pallet also helps to make sure the instrument is correctly shipped.

NEVER allow IMU4000 to be transported on its side or upside down.

9.2 Transport

If you transport the IMU4000 for outdoor EMC tests, the military box from EMC PARTNER is recommended.

If you are transporting the IMU4000 to an EMC PARTNER field office for repair, attach a tag to the equipment showing the instrument owner and address, the name of the person to contact about the instrument, the instrument type and the serial number.

10 Recycling / Disposal

10.1 RoHS directive 2002/95/EG

The IMU4000 generator complies with the directive 2002/95/EG (RoHS - Restriction of certain Hazardous Substances).

From December 2005, all EMC Partner products either hand soldered or by machine are produced using lead-free solder.

10.2 WEEE directive 2002/96/EG

The EMC Partner IMU4000 generator, is exempted from the directive 2002/96/EG (WEEE) under category 9.

The product should be recycled through a professional organisation with appropriate experience for the disposal and recycling of electronic products. EMC Partner are also available to help with questions relating to the recycling of this product.

10.3 Information for dismantling



Always remove power cord first.

There is no special danger involved in dismantling the IMU4000.

10.4 Parts which can be recycled

The IMU4000 contains parts made from steel, aluminium, PVC, two-component sealing compound. The impulse capacitors are filled with non-poisonous mineral oil. The various parts can be separated and recycled.

10.5 Parts which cannot be recycled

All parts in the IMU4000 can be recycled.

11 Accessories

11.1 TRA accessories to IMU4000 Versions

Visit our Web site to get a complete overview about the accessories

Selection of three phase CDN

PN	Type	Short description
105114	CDN-A-06-32-AC-DC	Automatic Coupling / Decoupling Network for SURGE and EFT Coupling onto 2 STRINGS DC+ and DC- up to 1000V and onto AC 3P/690V and 32A continuous. AC and DC over current protected For use with TRA2006 and TRA3000.
104117	CDN-A-3P100-480 F	Three phase CDN with line voltages L to N/PE=280V and L to L=480V, line current 100A per phase. Automatic coupling path selection for EFT controlled by TRA2000, TRA2004, TRA2006 and TRA3000.
104116	CDN-A-3P100-480 F-S	Three phase CDN with line voltages L to N/PE=280V and L to L=480V, line current 100A per phase. Automatic coupling path selection for EFT and SURGE controlled by TRA2000, TRA2004, TRA2006, TRA3000 and MIG0603INx with SN > 199.
104119	CDN-A-3P100-690 F	Three phase CDN with line voltages L to N/PE=398V and L to L=690V, line current 100A per phase. Automatic coupling path selection for EFT controlled by customized TRA2000, TRA2004, TRA2006 and TRA3000. The generator must be ordered together with the CDN.
104118	CDN-A-3P100-690 F-S	Three phase CDN with line voltages L to N/PE=398V and L to L=690V, line current 100A/Phase. Automatic coupling path selection for EFTand SURGE controlled by customized TRA2000, TRA2004, TRA2006, TRA3000, and MIG0603INx with SN > 199. The generator must be ordered with CDN.
105849	CDN-A-3P100-AC-DC	Three phase CDN with line voltages L to N/PE=398V and L to L=690V, d.c 1000V line current 100A/Phase. Automatic coupling path selection for EFTand SURGE controlled by customized TRA2006 and MIG0603INx with SN > 199. The generator must be ordered with CDN.
105076	CDN-A-3P200-480 F-S	Three phase CDN with line voltages L to N/PE=280V and L to L=480V, line current 200A per phase. Automatic coupling path selection for EFT and SURGE controlled by TRA2006, TRA3000 and MIG0603INx with SN > 199. A.c and D.c over current protection.
105077	CDN-A-3P200-690 F-S	Three phase CDN with line voltages L to N/PE=398V and L to L=690V, line current 200A/Phase. Automatic coupling path selection for EFTand SURGE controlled by modified TRA2006, TRA3000, and MIG0603INx with SN > 199. Generator modification only at EMCP .
103475	CDN2000-06-32	Three phase CDN with line voltages L to N/PE=280V and L to L=415V, line current 32A per phase. Manual coupling path selection for EFT, SURGE and RING.

Accessories

PN	Type	Short description
103477	CDN2000A-06-32	Three phase CDN with line voltages L to N/PE=280V and L to L=415V, line current 32A per phase. Automatic coupling path selection for EFT, SURGE and RING controlled by TRA2000, TRA2004, TRA2006, TRA3000 and MIG0603INx with SN > 199.
103695	CDN2000A-06-32 480V	3 phase CDN with line voltages L to N/PE=280V and L to L=480V, line current 32A per phase. Automatic coupling path selection for EFT, SURGE and RING controlled by TRA2000, TRA2004, TRA2006, TRA3000 and MIG0603INx with SN > 199.
103493	CDN2000A-06-32 690V	3 phase CDN with line voltages L to N=398V and L to L=690V, synchronisation output line current 32A per phase, auto coupling path selection for EFT and SURGE controlled by TRA2006, TRA3000 F-S or MIG0603INx
103582	CDN2000A-06-63	Three phase CDN with line voltages L to N/PE=280V and L to L=480V, line current 63A per phase. Automatic coupling path selection for EFT and SURGE controlled by TRA2000, TRA2004, TRA2006, TRA3000 and MIG0603INx with SN > 199.
106425	CDN-KIT1000 ED3	SURGE coupling-decoupling network for data lines according to IEC 61000-4-5 Ed.3. New calibration procedure.

Accessories for calibration

PN	Type	Short description
106137	VERI-C18-S	18µF cap for surge current calibration at sc, IEC 61000-4-5 Ed.3 Application: Calibration of generator without 18µF capacitor on direct output Coupling capacitor between SURGE generator and external CDN
104668	VERI-CP-EFT	Transducer plate for capacitive coupling clamp calibration. Connector HV BNC with 15cm strap to bond to the reference ground plane. Requires VERI50 EFT
103474	VERI-DIPS	Measuring set for calibration / verification of the inrush current TRA1000, TRA200xxx, TRA3000, PFS32 and PFS63.
103473	VERI1K EFT	1kOhm termination with high voltage BNC and integrated divider for EFT calibration / verification.
103472	VERI50 EFT	50 Ohm termination with high voltage BNC connectors and integrated divider for EFT calibration / verification.
103641	ADAPTER EFT-CDN	Adapter for EFT calibration / verification at single or three phase CDN-EFT outputs. Remark: EFT measurement without power supply connected to CDN. Usable with CDN 25, 32 and 63A per phase.
104968	ADAPTER EFT100	Adapter for EFT calibration / verification at 100A three phase CDN CDN outputs: Remark: Consist of two parts; 1 ground strap and 1 adapter. EFT measurement without power supply connected to CDN.

11.2 Use of TRANSIENT accessories

Accessories to TRANSIENT generators have a limited rated SURGE voltage. The maximum SURGE peak output voltage of the IMU4000 is 8kV.

To avoid damages of the TRANSIENT accessories, the IMU4000 includes the following features:

11.2.1 Hardware: ADAPTER BOX TRA-ACC, PN 106427

For auto controlled accessories with a communication port, a box can be inserted into the communication line. When the setting of the ADAPTER BOX TRA-ACC corresponds with the connected accessories, automatically the IMU4000 will limit the output voltage to the rated voltage of the connected accessories.



PN	Short description	IMU	Max SURGE voltage
103477	CDN2000A-06-32	x	6000
103695	CDN2000A-06-32 480V	x	6000
103493	CDN2000A-06-32 690V	x	6000
103582	CDN2000A-06-63	x	6000
103569	CDN3000A-06-25	x	6000
105079	CDN3000A-06-25 690V	x	6000
106433	CDN3000A-08-32 690V	x	6000
104117	CDN-A-3P100-480 F	x	6000
104116	CDN-A-3P100-480 F-S	x	6000
104119	CDN-A-3P100-690 F	x	6000
104118	CDN-A-3P100-690 F-S	x	6000
105849	CDN-A-3P100-AC-DC	x	6000
105076	CDN-A-3P200-480 F-S	x	6000
105077	CDN-A-3P200-690 F-S	x	6000

For further information see Instruction sheet of the ADAPTER BOX TRA-ACC.

11.2.2 Software: Firmware IMU4000

Press: Menu – System - Ext. Accessory – Change Accessories

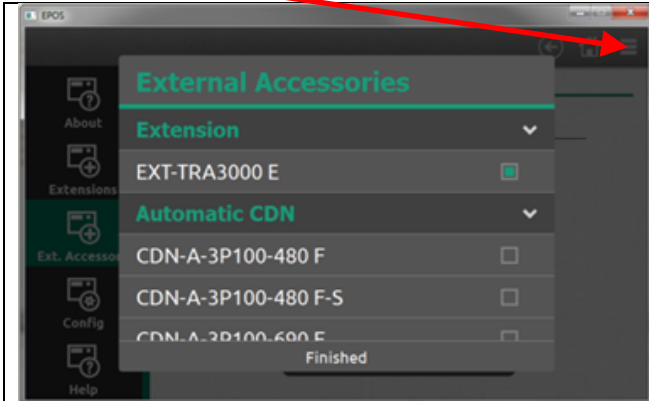

Select all EMC PARTNER accessories from the list available in your laboratory.

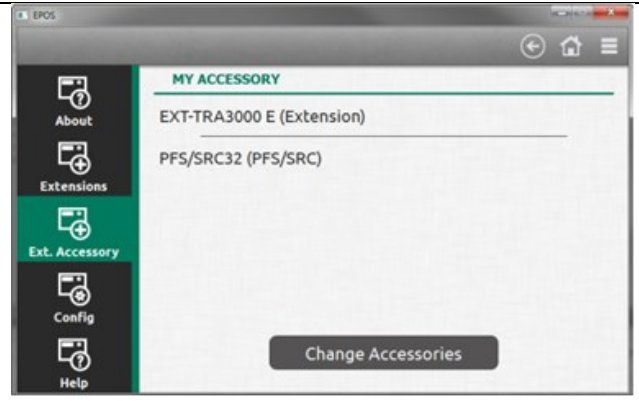

When you press “Finish” you will see all EMC PARTNER accessories in the windows above.

Example SURGE:

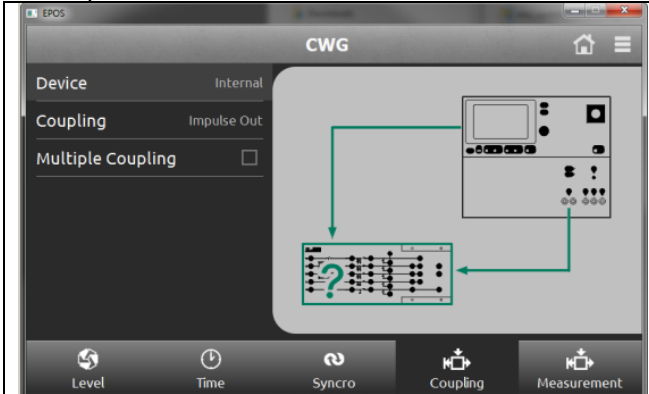

Select all EMC PARTNER accessories from the list available in your laboratory.

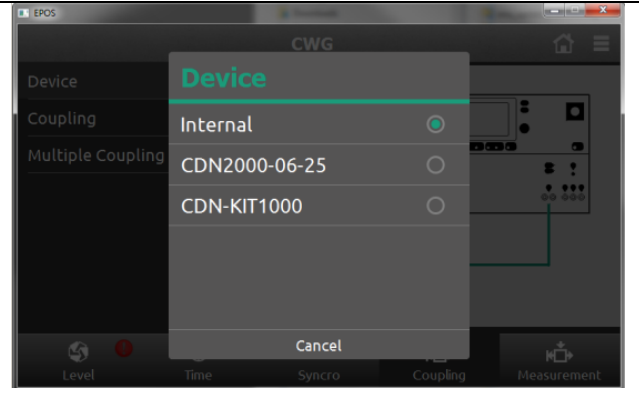

When you press “Device” you will see only the CDN previous selected and available in your laboratory. Select the desired CDN and start the EMC test.

PN	Short description	IMU	Max SURGE voltage
103476	CDN2000-06-25	x	6000
103693	CDN2000-06-25 480V	x	6000
103475	CDN2000-06-32	x	6000
103471	CDN-KIT1000	x	6000
106425	CDN-KIT1000 ED3	x	6000
106426	CDN-UTP ED3	x	6000
106326	CDN-UTP8 ED3	x	6000
103480	MF1000-1	x	5000
103481	MF1000-2	x	5000

12 Remote Ports

12.1 General

12.1.1 Ethernet port setting on IMU4000

The following steps must be carried out on IMU4000 to remote control from a local PC

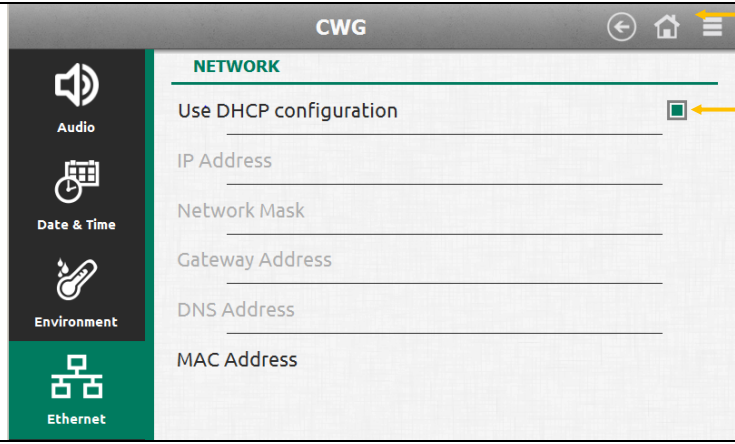
		<p>General menu pull down windows</p> <p>Touching a line will open an additional windows</p> <p>The parameter in the additional windows are valid for all test</p>
--	--	--

Set the Local IP Address to example 192. 168. 0.140

12.1.2 IP address setting on PC

The following steps must be carried out to control the IMU4000 from a local PC

Open the network windows as shown below:

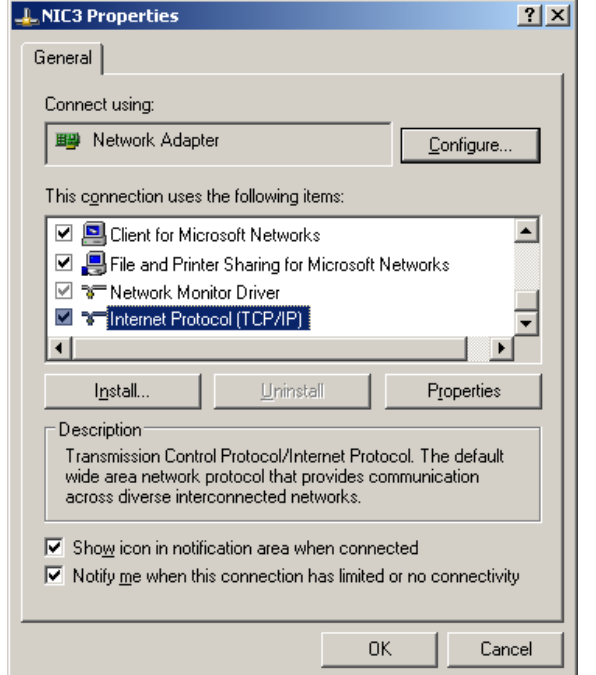
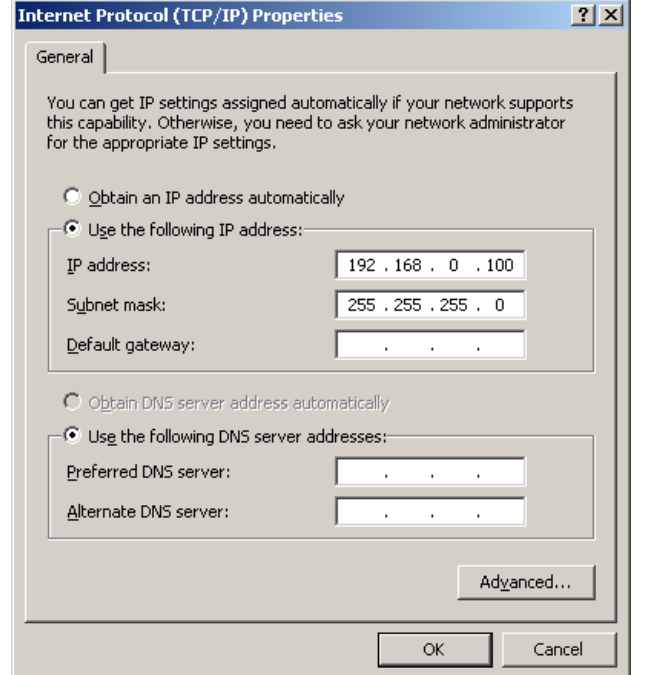
	
<p>Select the internet protocol</p>	<p>Set the PC IP address to 192. 168. 0.100</p>

Remote Ports

Connect with Ethernet cable type (crosswire) delivered with the IMU4000 standard accessories the PC to the IMU4000.

When the TEMA3000 is installed on the PC, then the IMU4000 can be remote controlled from the PC.

12.1.3 Using Web Browser

For Web server access, start your web browser (internet explorer, Morzilla, Firefox,...) and write the IMU4000 IP address. Example: http://192.168.0.140

12.2 Software "TEMA3000" for IMU4000

The TEMA3000 software delivered on a CD, can be used to control the IMU4000 Versions via the Ethernet port. The software must be ordered separately.

12.2.1 TEMA3000 Basic

The screenshot shows the TEMA3000 software interface. On the left is a dark sidebar with five main menu items, each with an icon and sub-options: **Generator** (EPOS, Type, Settings, Connection), **DSO** (Digital Storage Oscilloscope), **Single Test** (Load & Save, Edit, Parameters), **Test Sequence** (Load & Save, Edit, Parameters), and **Test-Library** (EMC PARTNER, Test-Library). The main window has a header with 'Start screen' and 'EMC - PARTNER' logos. Below the header is a navigation bar with 'License', 'Help', 'About', and 'Exit' buttons. The central area features the 'TEMA 3000' logo and the tagline 'TEST MANAGER FOR THE FUTURE'. The main content is titled 'The new generation Test Management Software' and contains three circular images with descriptive text: 1. A blue generator unit with text: 'Add your generator and start to remote control right from your PC.' 2. A computer monitor displaying a waveform with text: 'Extend Tema3000 with the DSO module to control both your generator and your DSO together.' 3. A complex test setup with text: 'Create complete test and combine them to form complex test sequence.' At the bottom right, there is a 'TEMA 3000' logo and a grid of buttons.

The TEMA3000 Software and their modules

PN	Type
106203	TEMA3000
106204	TEMA3000-DSO
106205	TEMA3000-LIBRARY
106206	TEMA3000-SEQUENCE
106207	TEMA3000-PROTOCOL

TEMA3000 includes Generator and remote control

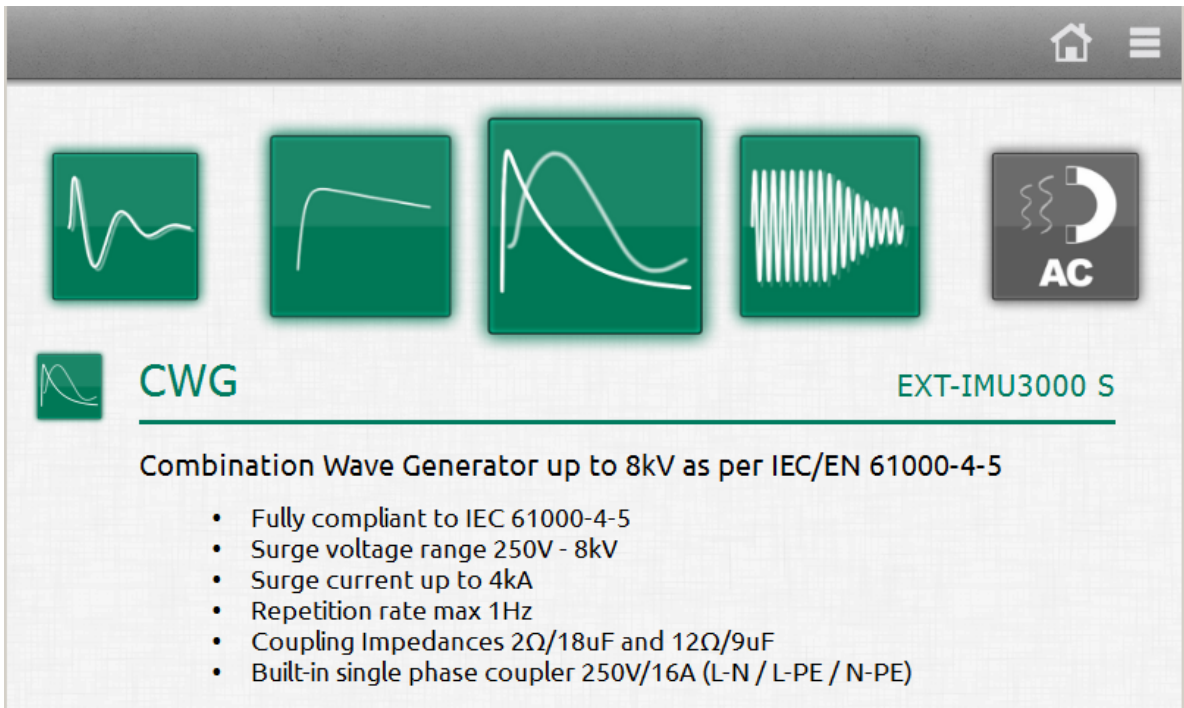
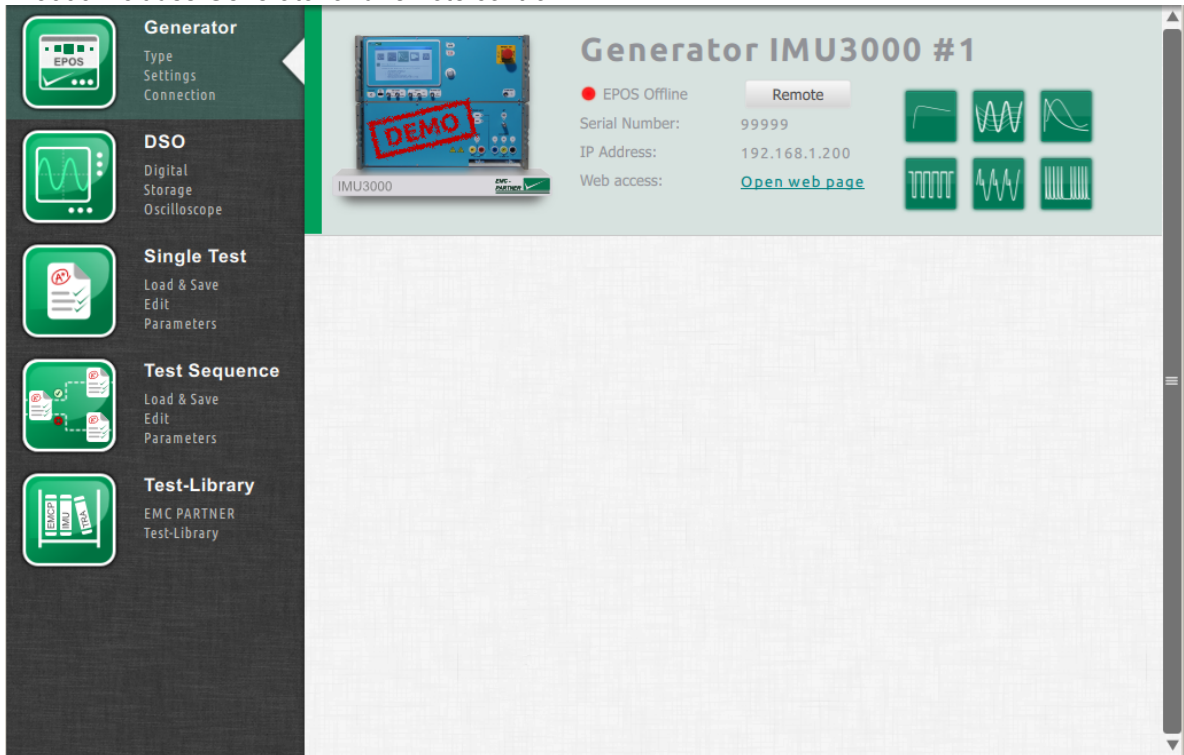

The TEMA3000 setting is identical to the IMU4000 setting on the touch screen.



Detailed information can be obtained from the help file of TEMA3000 Software.

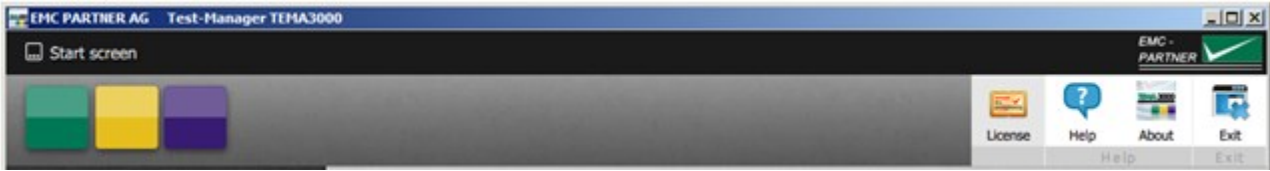

EMC PARTNER AG Test-Manager "TEMA3000" Documentation



Thank you for choosing TEMA3000. If you have any questions that are beyond the scope of this help file, please feel free to contact EMC PARTNER or your local representative. Thank you very much!

Table of Contents

- A. [TEMA3000 System Requirements](#)
- B. [Getting Started](#)
- C. [Network configuration](#) *(Connect Tema to your generator)*
- D. [Generators](#)
- E. [Single Test](#) *(Create and run automated tests)*
- F. [Protocols](#)
- G. [Test Sequence](#)
- H. DSO
- I. Test Library
- J. [Key Manager](#) *(manage your licenses to unlock Tema features)*



13 Appendix and Corrections

13.1 Appendix

13.1.1 Definition of the EFT Waveform

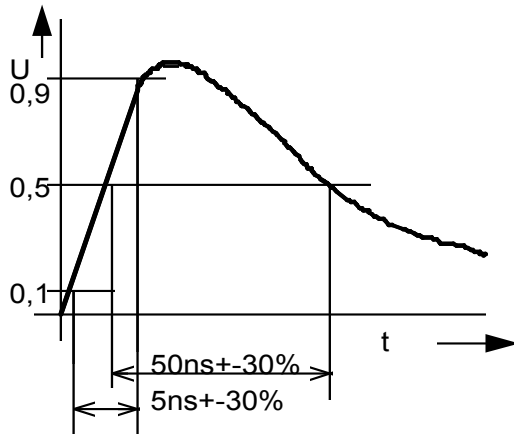

a) Spannungsform gemessen an 50 Ohm
Waveform measured at 50 Ohm

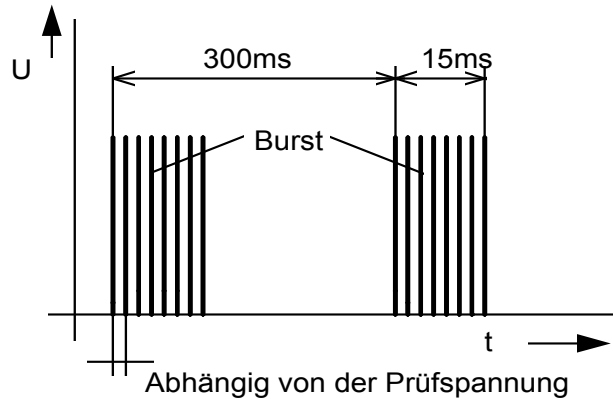

b) Burst Prüfsequenz
Burst test sequence

IEC 61000-4-4-Ed.2 specifies a verification of the waveform at 1000 Ohm

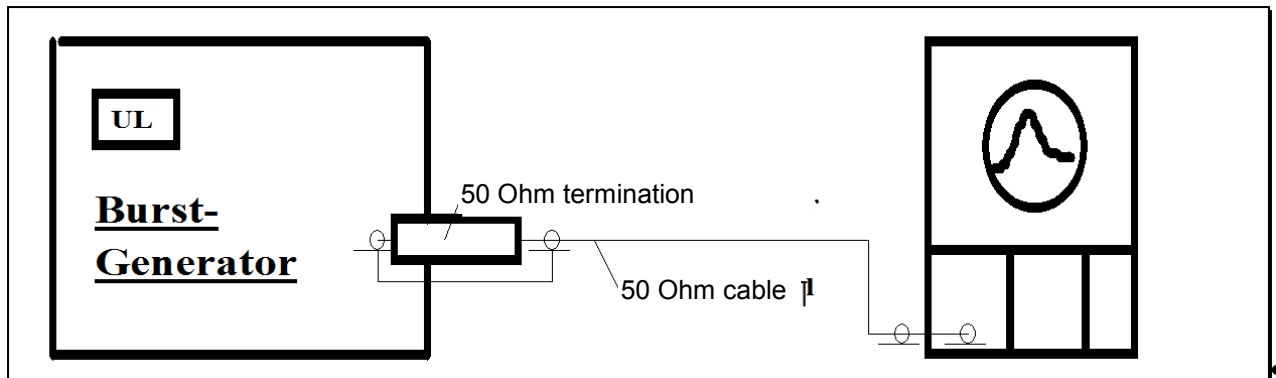

Memory oscilloscope
50 Ohm input

Checking the EFT tester. Checking procedure

1. The 50 Ohms terminating resistor, including the voltage divider, must be examined with a sinusoidal voltage (CW) between 100 kHz and 200 MHz
2. The rise time must be between 3.5 and 6.5 ns.
3. The time to half value must be between 35 and 65 ns.
4. The source impedance of the tester is 50 Ohm, providing the coefficient of $UL/U_{out} = 2$.
 UL = charging voltage
 U_{out} = output voltage into 50 Ohm

13.1.2 Definition of the ESD Waveform

IEC 61000-4-2 Ed.2

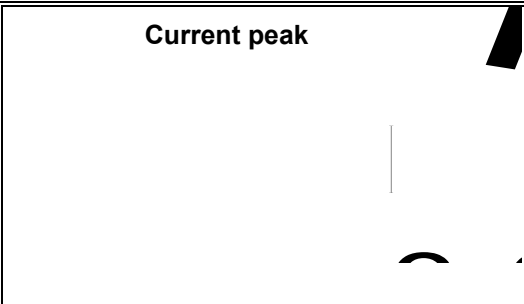
Level	Test voltage kV±5%	Peak current A±15%	Amplitude at 30ns A±30%	Amplitude at 60 ns A±30%	
1	2	7,5	4	2	
2	4	15	8	4	
3	6	22,5	12	6	
4	8	30	16	8	

It is only possible to check the impulse current by using very expensive measuring equipment. The price of such an instrument today lies at approx. 50 k\$. In addition, persons who carry out such tests must have some experience with high voltage and high frequency test work, so that they can interpret the measured values. The calibration and verification of the generators must be carried out by the manufacturer or the official calibration authorities.

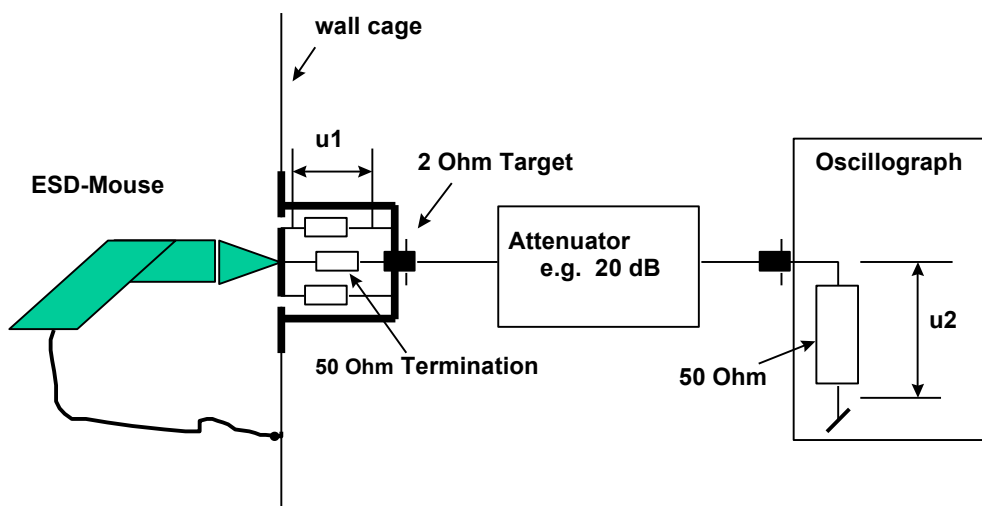

IEC 61000-4-2 Ed.1

The ESD-current produces on 2 Ohm Shunt a voltage drop u_1 . The 2 Ohm target is terminated with 50 Ohm to avoid reflection. With the 20 dB attenuator the 60V drop on the 2 Ohm will be reduced to the allowed input voltage of the oscilloscope. The memory oscilloscope must have a minimum bandwidth of 1 GHz. For all four levels (2,4,6,8 kV) the current wave-form must be within the tolerances as specified in the IEC standard 61000-4-2.

IEC 61000-4-2 Ed.2

The ESD-current produces on 2 Ohm Shunt a voltage drop u_1 . The 2 Ohm target is no longer terminated with 50 Ohm. To avoid reflection the attenuator must be inserted on the target side. With the 20 dB attenuator the 60V drop on the 2 Ohm will be reduced to the allowed input voltage of the oscilloscope. The memory oscilloscope must have a minimum bandwidth of 2.5 GHz. For all four levels (2,4,6,8 kV) the current wave-form must be within the tolerances as specified in the IEC standard 61000-4-2 Ed.2.

13.1.3 Definition of the SURGE Waveform

CWG Combination Wave Generator

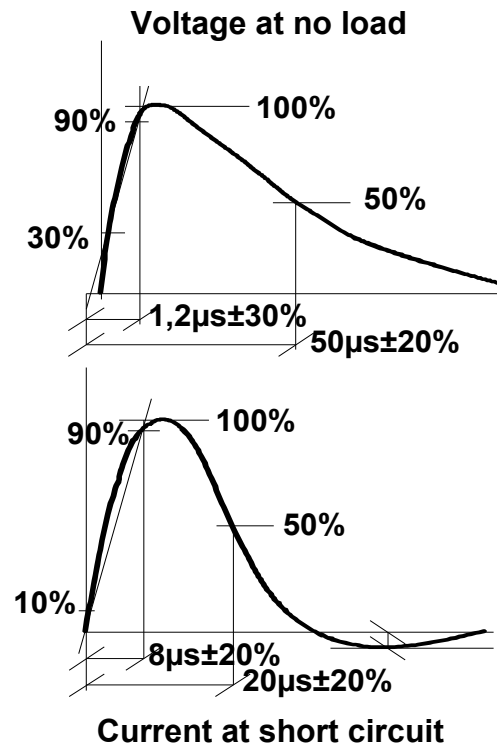
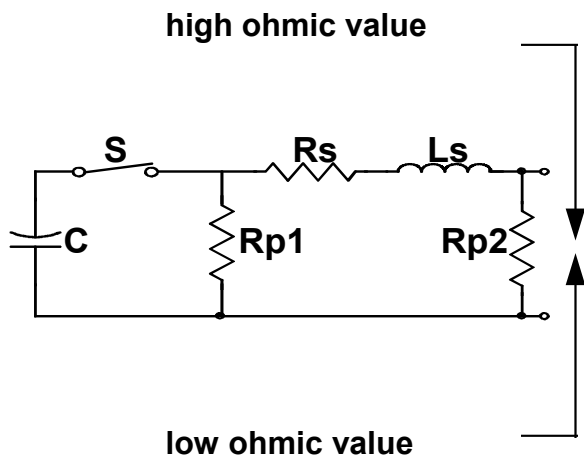

With this information the SURGE circuit of the IMU4000 can be easily verified.

Example: "Voltage"

- choose 1 kV charging voltage
- measure the no load voltage at the generator output. Check whether the wave-form is within the tolerances or not.

Surge voltage front time $T1=1.2 \mu\text{s} \pm 30\%$	0.84 - 1.56 μs
Time to half value $T2= 50 \mu\text{s} \pm 20\%$	40 - 60 μs
measure U_{max} .	

Example "Current"

- choose 1 kV charging voltage
- measure the short circuit current at the generator output. Check whether the waveform is within the tolerances or not.

Surge current front time $T1= 8 \mu\text{s} \pm 20\%$	6.4 - 9.6 μs
Time to half value $T2=20 \mu\text{s} \pm 20\%$	16 - 22 μs
measure I_{max}	

Check the source impedance:

$$U_{\text{max}} / I_{\text{max}} = 2 \text{ Ohm} \pm 10\%$$

13.1.4 DIPS Specification

Test levels DIPS

Test Level % U_T	Voltage Dip/int % U_T	Duration (in period)
0	100	0.5* 5 10 25 50 x
40	60	
70	30	

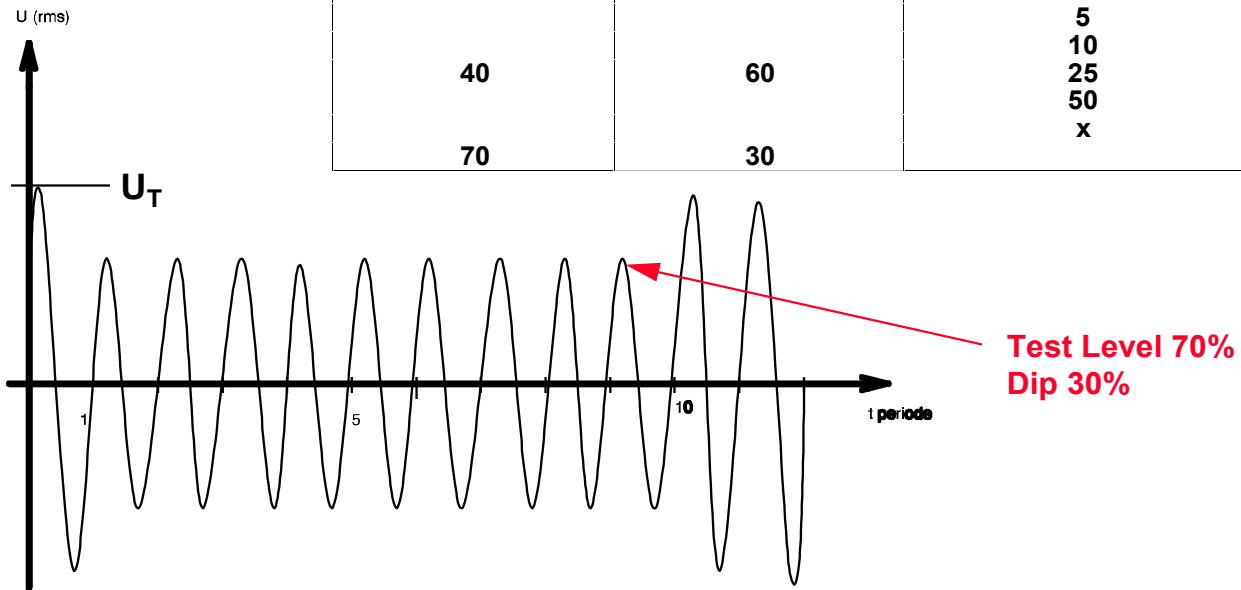

In addition to the data showed in the figure, such as test levels, duration of the interruption, transition time, etc., the inrush current must be tested. Electronic equipment very often contain inrush current limitation circuits. These inrush limiting circuits are often bypassed during interrupts at the turn on part. Consequences are defective power switching modules, or the equipment cannot be turned on after the test because the software has not made a restart etc.

So that the test will cover this aspect, the inrush current capability of the generator must be at least 500 A peak. The verification of the generator inrush current is defined as follow:

Turn on the generator at a phase angle of 90 degrees. Using a current sensor, measure the current in a capacitor of several μF . The measured amplitude must be equal to/or greater than 500 A. When the tester can generate a current amplitude of 500 A, all equipment with current consuming up to 16 A can then be tested.

If the current amplitude of 500 A is not reached, then the inrush current of the EUT must be measured. The inrush current of the tester must be a minimum of 30 % higher than the inrush current of the EUT.

13.1.5 VARIATION Specification IEC 61000-4-11 Ed.1

Test levels Voltage variation

VoltageTest Level	Time for decreasing Voltage	Time at reduced voltage	Time for increasing voltage
40 % U_T	2 s ± 20 %	1 s ± 20 %	2 s ± 20 %
0 % U_T	2 s ± 20 %	1 s ± 20 %	2 s ± 20 %
	'x' 1)	'x' 1)	'x' 1)

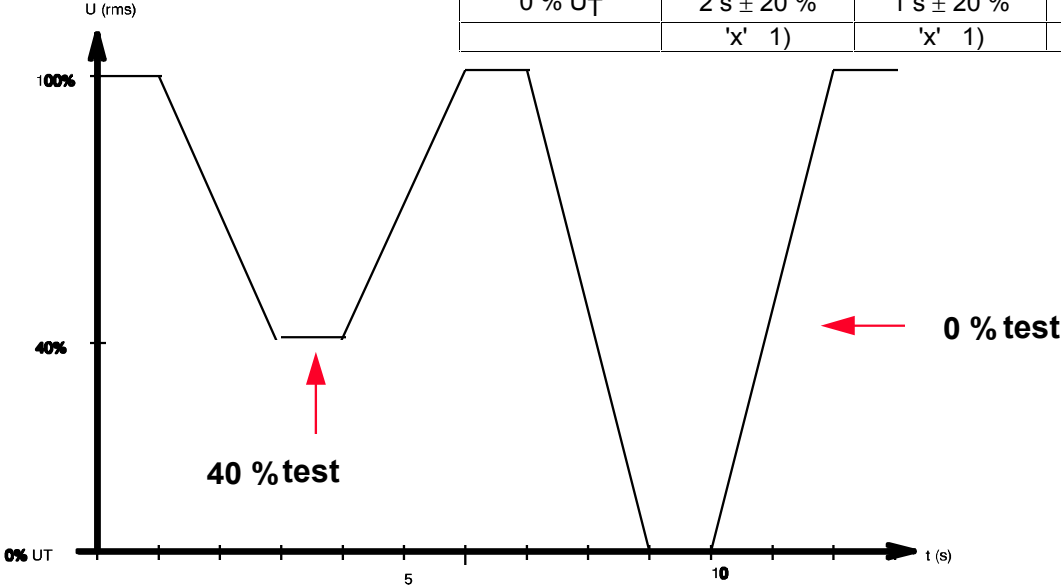

13.1.6 VARIATION Specification IEC 61000-4-11 Ed.2

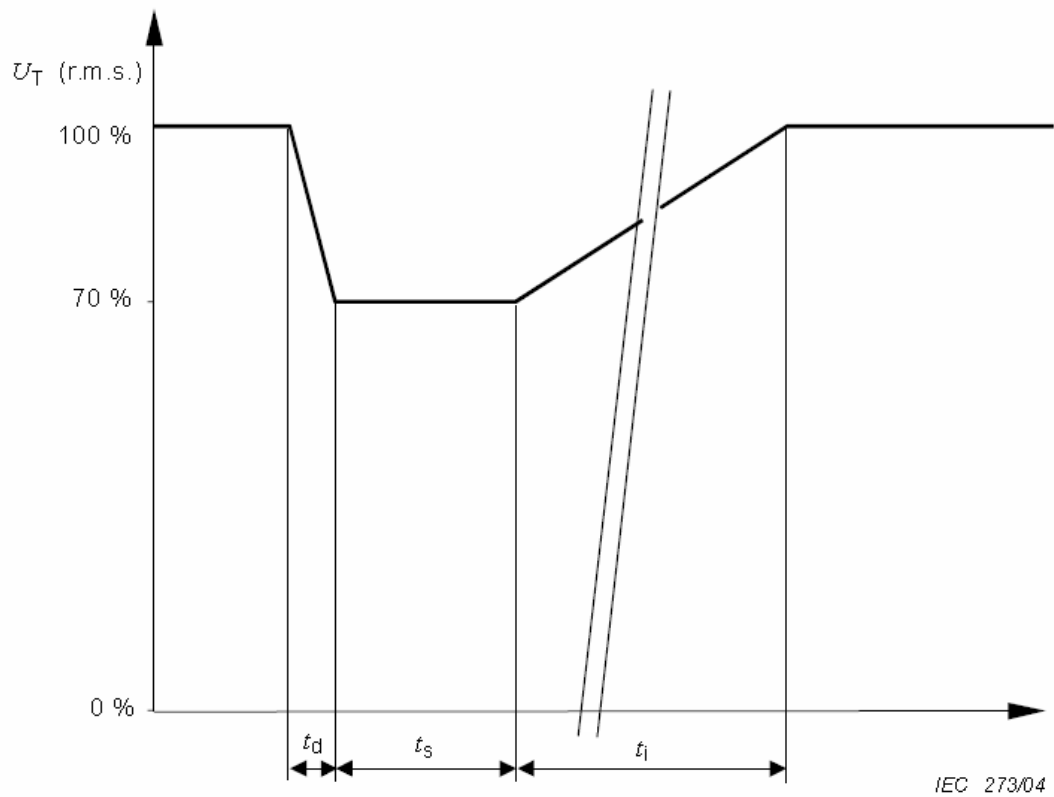

Key

- t_d Time for decreasing voltage
- t_i Time for increasing voltage
- t_s Time at reduced voltage

Voltage test level	Time for decreasing voltage (t_d)	Time at reduced voltage (t_s)	Time for increasing voltage (t_i) (50 Hz/60 Hz)
70 %	Abrupt	1 cycle	25/30 ^b cycles
X ^a	X ^a	X ^a	X ^a

^a To be defined by product committee.

^b "25/30 cycles" means "25 cycles for 50 Hz test" and "30 cycles for 60 Hz test".

13.2 Correction

13.2.1 Declaration of conformity to the EMC directive 2004/108/EC

See appendix at the end of this documents.

13.2.2 Declaration of conformity to the LV directive 2006/95/EC

See appendix at the end of this documents.

13.2.3 Declaration of conformity to the Basic Standards

See appendix at the end of this documents.







14 Glossary

Wherever possible, definitions in accordance with IEC 50 (IEV 161) are used.

EUT	Equipment under Test
EST	French abbreviation of EUT
EMV = EMC = CEM	Electro Magnetic Compatibility German: Elektromagnetische Verträglichkeit French: compatibilité elctromagnétique
Hybrid pulse	Voltage at no load 1.2 / 50 μ s and current at short circuit 8 / 20 μ s.
CWG	Definition in IEC 61000-4-5 used for Surge Combination wave Generator.
CM	Common Mode voltage test defined in IEC 61000-4-16
Coupling network	Electric circuit for transferring energy with low losses from one circuit into another circuit.
Decoupling network	Electric circuit to prevent transmitting energy from one circuit into another circuit.
CDN coupling decoupling network (single or three phase unit)	Consist of a coupling and a de-coupling network.
EFT	Electric Fast Transient (switched inductance)
ESD	Electric Static Discharge
SURGE	Transients with high energy content with relatively low frequency content As produced by lightning and switching of power lines.
DIP	Short voltage interruption or short voltage drop
IEC	International standardisation organisation for electronic technology
VARIAC	Voltage variable transformer
SPIKE	One pulse of the burst
CRO	oscilloscope
HV	High Voltage
rms.	root mean square; effective value

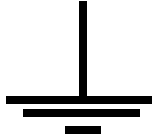
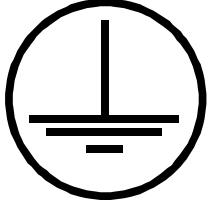
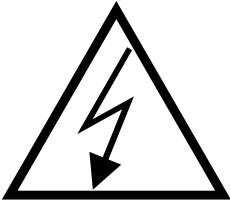
Glossary

Used symbols:

	<p>Direct current</p>
	<p>Alternating current</p>
	<p>Three phase alternating current</p>
	<p>Earth (ground) terminal</p>
	<p>Protective conductor terminal IEC 417, No. 5019</p>
	<p>Caution, risk of electric shock ISO 3864, No. B.3.6</p>
	<p>Caution (refer to accompanying documents) ISO 3864, No. B.3.1</p>
	

15 Index

<hr/>		EUT	97
A		EUT d.c. supply 1 Input	46
Attention refer to manual	30, 34, 42, 47	EUT Power 1 Inputs	44
Attention refer to manual (45)	44	EUT Power 2	44
Attention refer to manuel	32	EUT Power measuring outputs	40
AUX	42	External Variac	49
<hr/>		F	
C		Forced cooling	45
Calibration at EMC PARTNER	71	<hr/>	
CE mark	43	H	
Check before operation	47	High voltage pulse output EFT	42
Climatic Condition	29	High Z Mode	37
Common Mode Disturbance		<hr/>	
source	12	I	
Control		Impulse output SURGE (30,31)	42
Indication and LED colours	39	Impulsforming Network	36
Technical Data	24	Indication of voltage variation (25	42
control keys		Internal Variac	49
Operation panel	41	Internal Variac connection	48
Control panel		<hr/>	
Control part	39	L	
Control Panel		Leakage current	48
Front of the TRA3000 F-S-D-V-C	39	<hr/>	
Coupling network	97	M	
Coupling-Decoupling Network	37	Maintenance	69
CWG	97	Measuring Circuit	37
<hr/>		Measuring circuits	
D		Technical Data (BNC-Connectors)	23
dc power on EUT	50	Mechanical dimension	25
Decoupling network	97	Mechanical structure	
DIPS		19" Insert version	35
Hints to test set-up	55	Standard	35
source	11	With military box	35
Technical data	21	Monitor (1)	40
<hr/>		<hr/>	
E		N	
Earth connection (34)	42	Numeric control panel (18)	40
EFT		<hr/>	
characteristics	11	O	
coupling-decoupling network CDN	18	Operational Conditions	29
Hints to the test set-up	52	<hr/>	
Quick verification by the user	70	P	
source	9	Packaging and shipment	77
Technical data	18	Pause	66
EFT Run Mode	67	personal safety	29
Electromagnetic Compatibility	30	<hr/>	
EMC	97		
Emergency Stop	42, 45, 66		
ESD			
Run Mode	67		
source	9		
Tecnical data	17		
ESD characteristics	11		
Ethernet			
Remote control	45		
Ethernet port	85		

Index

Power EUT (24)	42
Power line voltage, power consumption	25
Power supply of the IMU4000	43
Push button ON/STBY (6)	40

R

Recycling/Disposal	79
Run (5)	40
Run (8)	40
Run Mode	66

S

Safety	
Precautionary measure	30
Safety	
Standards	29
Seminars	47
Service, Repair	74
Single phase power output	41
Standby Mode	66
SURGE	97
Coupling network	20
hints to test set up	54
source	10
Technical Data	20

SURGE Measuring outputs	41
Symbols	98

T

Test	97
test set-up for table top equipment	56
touch screen information	59
Trigger input	46
Trigger output for oscilloscope (13)	41
Triggering	
External Measuring equipment	24
Type plate	43

V

Variac Control	43
VARIATION	
Technical Data	22
Versions TRA3000 F-S-D-V-C	12

W

Warnings	43
----------	----

Declaration of Conformity to Standards

The EMC Tester

Type: IMU4000

Complies with the following standards:

EFT
ESD
a.c. MF
Surge MF
DIPS and INTERRUPTION on a.c. power
INTERRUPTION on d.c.

IEC/EN 61000-4-4 Ed.3
IEC/EN 61000-4-2 Ed.2
IEC/EN 61000-4-8 Ed.2 with antenna
IEC/EN 61000-4-9 Ed.1 with antenna
IEC/EN 61000-4-11 Ed.2 single phase
IEC/EN 61000-4-29 Ed.1



Laufen, 02. February 2014

EMC PARTNER AG



M. Lutz
Managing Director

EMC PARTNER AG



R. Henz
Manager Quality

Appendix to 14.2.3 Conformity declaration with basic standards



Manufacturer Declaration Of Conformity LV

Directive 2006/95/EC;

The EMC Tester

Type: IMU4000

is designed and manufactured complying with the following harmonised standards:

Harmonised:
EN 61010-1: 2010

international
IEC 61010-1: 2010

in accordance with the regulation of LV - directive of the members states 2006/95/EC

EMC PARTNER authorised representative established within the EC Community

H+H High Voltage
Technology GmbH
Im kurzen Busch 15
DE - 58640 Iserlohn

Laufen, 05.June 2013

EMC PARTNER AG



M. Lutz
Managing Director

EMC PARTNER AG



R. Henz
Manager Quality Department

Appendix to 14.2.2 Conformity declaration with Low Voltage Directive 2006/95/EC



Manufacturer Declaration Of Conformity EMC

Directive 2004/108/EC

The EMC Tester

Type: IMU4000

has been tested in accordance with the following standards:

harmonised:
EN 61000-6-3: 2007
EN 61326: 2006

international
IEC 61000-6-3
IEC 61326-1

Fulfilling the directions of the EMC - Directive 2004/108/EC

EMC PARTNER authorised representative established within the EC Community

H+H High Voltage
Technology GmbH
Im kurzen Busch 15
DE - 58640 Iserlohn

Laufen: 05.June 2013

EMC PARTNER AG



M. Lutz
Managing Director

EMC PARTNER AG



R. Henz
Manager Quality Department

Appendix to 14.2.2 K Conformity declaration with the EMC directive

