



ARTIFICIAL NETWORK (AN) HV-AN 150 & SME HV-AN 150

USER MANUAL



ARTIFICIAL NETWORK (AN) HV-AN 150

USER MANUAL

CONTENT

1.	Safety advice	5
1.1.	Safety and warning symbols	5
1.2.	Safety Aspects	6
1.3.	Connection to the mains and PE	6
1.4.	Connections to other ports with dangerous voltages (AE, EUT, RF port ...)	6
1.5.	Connection to the ground plane or Faraday cage	6
1.6.	Disconnection from the mains, PE, ground and control devices.....	7
1.7.	Use proper fuses	7
1.8.	Risk of electric shock.....	7
1.9.	Operating Environment	7
1.10.	Test execution	8
1.11.	Dangers concerning the generator.....	8
1.12.	Dangers concerning the EUT	8
1.13.	Applicable safety standards.....	8
1.14.	Intended use	9
1.15.	Warranty Terms	9
1.16.	Prohibition of unauthorized conversions and modifications.....	9
1.17.	Specific accessories required for safety reason	9
1.18.	Procedure in case of hazard	9
2.	Unpacking, storage and transport	10
2.1.	General	10
2.2.	Storage and transport	10
2.3.	Unpacking	10
2.4.	Scope of delivery	10
3.	Application and standard requirements	11
4.	Construction of the product	12
4.1.	EUT port	12
4.2.	AE port (connection to power supply for EUT).....	12
4.3.	Jumper settings.....	12
4.4.	Connection of the external 10 μ F to the AE port for application RTCA-DO-160G	13
4.5.	Equivalent circuits in relation to the jumper settings	13
5.	Use of the shielded metal enclosure	15
5.1.	View of the closed SME HV-AN 150.....	15
5.2.	View of the opened SME HV-AN 150.....	15
5.3.	View to the connectors	15
6.	Technical specification HV-AN 150	16
6.1.	Electrical specifications	16
6.2.	Mechanical specifications	16
6.3.	Environmental conditions	16
7.	Technical specification SME HV-AN 150	17
8.	Maintenance	18
8.1.	General.....	18
8.2.	Cleaning	18
9.	Disposal	18







1. SAFETY ADVICE



Observe all precautions to assure your personal safety. Read the user manual carefully. Pay special attention to safety and operation details!

1.1. Safety and warning symbols

Please take note of the following explanations of the symbols used in order to achieve the optimum benefit from this manual and to ensure safety during operation of the equipment.

		<p>This symbol warns of a potential risk of shock hazard. Use standard safety precautions to avoid personal contact with these voltages.</p>
		<p>This symbol indicates where a caution is required. Refer to the operating instructions located in the manual in order to protect against personal injury or damage the equipment. It calls attention to a procedure, practice or condition which, if not followed, could possibly cause damage to equipment. Such damage may invalidate the warranty. Do not proceed until its conditions are fully understood and met.</p>
		<p>This symbol indicates non-ionizing radiation. Non-ionizing radiation may pose a health hazard to operators. Protective measures such as switching off the RF before entering the Faraday cage, level limitation and/or spatial distance are common measures.</p>
		<p>This symbol indicates access of persons with pacemakers prohibited.</p>
		<p>This symbol indicates the ground terminal.</p>
		<p>This symbol indicates the protective earth terminal.</p>

1.2. Safety Aspects

These operating instructions form an integral part of the equipment and must be available to the operating personnel at all times. The user must obey all safety instructions and warnings.

Neither AMETEK CTS Europe GmbH nor any of its subsidiary sales organizations can accept any responsibility for personal, material or consequential injury, loss or damage that results from improper use of the equipment and accessories.



WARNING

Improper or careless handling can be fatal!
Use of the generator is restricted to authorized and trained specialists

1.3. Connection to the mains and PE

- The instrument conforms to protection class 1. Operation without a protective earth connection is forbidden!
- Before switching on the device, check whether the selected voltage matches the supply voltage. The position of the voltage selector must correspond with the mains. If you change the mains voltage, replace the fuses according to the recommended value.
- A proper protective earth connection through the connector of the power cord is essential for safe operation.
- High leakage currents can cause the residual current circuit breaker of the mains to trip. In this case, the use of an isolating transformer is required.
- Handle the power cord carefully. Hold the plug when unplugging the cord.
- Never use the product if the power cord or the plug is damaged.
- Use only power cords and connector specified for your product.
- Do not abuse the cord. Never use the cord for carrying, pulling or unplugging the unit. Keep cord away from heat, oil, sharp edges or moving parts.
- Prevent the device from being switched on or energized unintentionally. Make sure that the switch is in the off position before connecting the device to the mains.
- Disconnect the power plug if you are not going to use the device for a long period of time.

1.4. Connections to other ports with dangerous voltages (AE, EUT, RF port ...)

- Only use the connection cables and plugs specified for your product which enable safe working. They must comply with the required classification and have suitable voltage and current ratings for the application.
- Handle the connection cable carefully. Hold the plug when unplugging the cable.
- Never use the product if the connection cable or plug is damaged.
- Avoid touching conductive parts unless they have been de-energized by suitable means and secured against being switched on again for the period of handling. Industrial connectors often have insufficient protection against electric shock due to their application.

1.5. Connection to the ground plane or Faraday cage

- Remove the protective foil from under the device and adapter housing to ensure good electrical contact.
- Light equipment should be weighted down, clamped to the base plate or other measures should be taken to ensure good electrical contact over a wide surface area and on a permanent basis.



- Connect the device with the ground plane before using.
- The operation without a second, only with a tool removable earth leakage connection is prohibited.
- Check the ground connection at regular intervals.

- Ensure that a reliable return path for the interference current is provided between the equipment under test (EUT) and the generator. The reference ground plane and the earth connections to the instrument as described in the relevant test standard serve this purpose well.

1.6. Disconnection from the mains, PE, ground and control devices

- Always set the power switch to the "Off" position and wait few seconds before disconnecting the power cord.
- Disconnect the power cord and all connection cords when moving the unit.

1.7. Use proper fuses

- To avoid fire hazard, use only fuses as specified in the parts listing for your product - matching type, voltage and current rating.

1.8. Risk of electric shock



WARNING

- To reduce the risk of electric shock, do not remove parts from the housing.
- There are no user serviceable parts inside the unit. Certain parts inside the instrument work at mains voltage or at high frequency and are not provided with any protection against being touched.
- Only approved accessory items, connectors, adapters, etc. are to be used to ensure safe operation.



WARNING

- The lines inside the device are not protected by a fuse. Therefore, the user must implement the protection of the device against short-circuits by means of suitable fuses.
- Avoid an overload by taking suitable precautions.
- In the event of a fault, dangerous and unexpected voltages may occur. Avoid touching conductive parts unless they have been de-energized by suitable means and secured against being switched on again for the period of handling.

1.9. Operating Environment

- Operate the equipment only in dry surroundings. Allow any condensation that occurs to evaporate before putting the instrument into operation. Do not exceed the permissible ambient temperature, humidity or altitude. Operate the unit not in explosive surroundings.
- No objects filled with liquids, such as coffee cups, shall be placed on the unit.
- Do not insert foreign objects in the ventilation holes.
- Do not obstruct the ventilation holes (also on the underside). Ventilation should not be impeded by covering the ventilation openings with items or other equipment.
- Avoid high temperatures. Allow for sufficient heat dispersion when installed in a rack. Do not place the product on radiators or fan heaters. The ambient temperature must not exceed the maximum specified temperature of this product.
- Keep the test area clean and well lit. Cluttered or dark areas invite accidents.

1.10. Test execution

- Check once again that all connections are proper including the ground and protective earth.
- Remove any adjusting key or wrench before switching on or energizing the device.
- The test area must be organized that no unauthorized persons have access during execution of a test.
- Operating the product requires special training and intense concentration. Make certain that persons who use the products are physically, mentally and emotionally fit enough to operate the products; otherwise injuries or material damage may occur.
- EUTs together with all accessories and cables are to be regarded as being live during the execution of a test.
- The safety instructions concerning all the instruments and associated equipment involved in the test setup are to be observed.
- The configuration of the test setup is to be strictly in compliance with the methods described in the relevant standard to ensure that the test is executed in a compliant manner.
- Working with high voltages alone is dangerous and prohibited by law.
- The high voltages must be switched off when nobody is present.

1.11. Dangers concerning the generator

- Local regulations for the protection of radio services must be observed. The interference generated by the generator can cause both conducted and radiated interference.
- If the radiated energy exceeds the permissible level, a shielded chamber with filtering of the supply lines or similar must be used. Decisive for the measures are the used levels, the geometry of the setup, the frequency range and the distance to the neighbor.
- Depending on the level used, the effectiveness of the connected antenna, TEM cell or similar, fields can be generated using appropriate power amplifiers, from which the operating personnel must be protected by suitable measures.
- Localized burning, arcing or ignition of explosive gases.
- Disruption of unrelated electronic, telecommunications or navigational installations or heart pacemakers through intentional and unintentional radiation of RF energy.



WARNING

Persons fitted with a heart pacemaker must not operate the instrument nor approach the test setup while it is in operation.

1.12. Dangers concerning the EUT

- EUTs are frequently simply functional samples that have not previously been subjected to any safety tests. Therefore in some cases, the EUT is quickly damaged through internal overloads caused by the control electronics being disrupted. The EUT may even begin to burn.
- As soon as the EUT shows signs of damage the test should be stopped and the equipment under test should be switched off.
- Possible erroneous behavior by the EUT for example, a robotic device may misbehave, or a temperature regulator may fail.
- Even when power is off, capacitors may retain an electrical charge.

1.13. Applicable safety standards

- Development and manufacture of the instrument complies with ISO 9001.
- The equipment conforms with the essential requirements of the Low Voltage Directive (LVD) 2014/35/EU based on DIN EN 61010-1.

1.14. Intended use



The purpose of this instrument is the coupling of defined interferences signals for EMI immunity testing. Depending on the test stand layout, configuration, wiring, and the characteristics of the EUT itself, a significant amount of electromagnetic radiation may be generated that can affect people as well as other equipment and systems. Likewise, this device can be used to decouple interfering signals for emission measurements.



WARNING

The device is designed for operation in industrial as well as home environment. For the intended operation, electromagnetic fields are generated by the connection of coupling devices (antennas, clamps, CDN etc.) or by the injection on lines. The operator, persons in the vicinity and the environment must be protected by suitable measures, e.g. Faraday cage.

1.15. Warranty Terms

AMETEK CTS provides this written warranty covering the product stated above, and if the buyer discovers and notifies AMETEK CTS in writing of any defect in material or workmanship within the applicable warranty period stated above, then AMETEK CTS may, at its option: repair or replace the product; or issue a credit note for the defective product; or provide the buyer with replacement parts for the product.

The buyer will, at its expense, return the defective product or parts thereof to AMETEK CTS in accordance with the return procedure specified below. AMETEK CTS will, at its expense, deliver the repaired or replaced product or parts to the buyer. Any warranty of AMETEK CTS will not apply if the buyer is in default under the purchase order agreement or where the product or any part thereof:

- is damaged by misuse, accident, negligence or failure to maintain the same as specified or required by AMETEK CTS;
- is damaged by modifications, alterations or attachments thereto which are not authorized by AMETEK CTS;
- is installed or operated contrary to the instructions of AMETEK CTS;
- is opened, modified or disassembled in any way without AMETEK CTS's consent; or
- is used in combination with items, articles or materials not authorized by AMETEK CTS.

The buyer may not assert any claim that the products are not in conformity with any warranty until the buyer has made all payments to AMETEK CTS provided for in the purchase order agreement.

1.16. Prohibition of unauthorized conversions and modifications

The user is not entitled to the device to perform its own modifications and adaptations. Modifying parts on the generator by unauthorized persons will void the warranty of the device and the correct functioning cannot be guaranteed.

1.17. Specific accessories required for safety reason

Only use accessories approved by AMETEK CTS for these generators and intended as accessories for these devices. Measuring instruments for the measurement of instrument parameters shall be designed for the maximum voltage and current from the generator. Otherwise safety cannot be guaranteed.

1.18. Procedure in case of hazard

If a hazard could exist due to an unintended condition of the device, the following procedure is recommended: Disconnect the device- and EUT power supplies from the power supply and ensure that the device is always earthed via the supply lines or a different ground connection. Wait at least 15 minutes and ground all outputs via a 10 k Ω , 15 W resistor. Call an AMETEK service center.

2. UNPACKING, STORAGE AND TRANSPORT

2.1. General

Save all packing materials! They will be needed in order to safely package the equipment for calibration service or repair.

Packaging materials

- Carton: Cardboard
- Padding: CFC-free polystyrene foam
- Plastic bags: Polyethylene





- Avoid the risk of condensation!

If a large temperature difference has occurred, allow time for the temperature to stabilize. This may take several hours.

2.2. Storage and transport

- Do not stack, either packaged or unpacked.
- Do not stand on end; arrows on the packaging must always point upwards.
- Protect from dampness, heat, cold and rain.
- Do not throw.
- Do not sit or stand on the instrument and packaging.

2.3. Unpacking

- Is the packaging damaged? If YES  transportation company
- Are all the packages present and correct? If NO  transportation company
- Open the packaging, remove the accessories.
- Grip the instrument at the sides and lift it from the packaging.
- Are the instrument or accessories damaged? If YES  transportation company
- Are the contents of the package complete? If NO  Teseq sales office
- Keep the instruction manual with the instrument.
- Keep the packaging.

2.4. Scope of delivery

Standard

Artificial network HV-AN 150

Operating manual

Options

Calibration certificate

EXT 10 μ F

SME HV-AN 150

3. APPLICATION AND STANDARD REQUIREMENTS

Teseq's 5 μH artificial network HV-AN 150 covers several applications and standards in the Automotive, Airborne and MIL range. It offers the right solution for both high current and high voltage EUTs and can be housed for having a shielded box as proposed in CISPR 12 (draft), CISPR 25, ECE No. 10 R05/R06 and ISO/DTS 7637-4.

The high voltage artificial network is designed for conducted emission tests and line termination during susceptibility tests for components. The HV-AN 150 is ideal for use in automotive, military and airborne standards applications. Thanks to its jumper settings, Teseq's HV-AN 150 offers a universal solution that covers the traditional way of testing as performed in CISPR 25, ISO 11452-1, ISO 7637-2, MIL-STD-461F and DO 160G. The combination of two networks in a shielded box enables the testing of shielded high voltage connections as seen in standard CISPR 12 (draft), CISPR 25, ECE No. 10 R05/R06 and ISO/DTS 7637-4. The shielded metal enclosure SME HV-AN 150 is designed to contain two HV-AN 150.

The distortion signals to be measured will be delivered to the coaxial output of the model HV-AN 150. The measuring instrument is connected to this coaxial output which has an impedance of $50\ \Omega$. Any suitable measuring receiver with $50\ \Omega$ input impedance can be used to perform the measurement, provided its frequency range and sensitivity is compatible. To protect the input circuit of the receiver from transients or pulses with

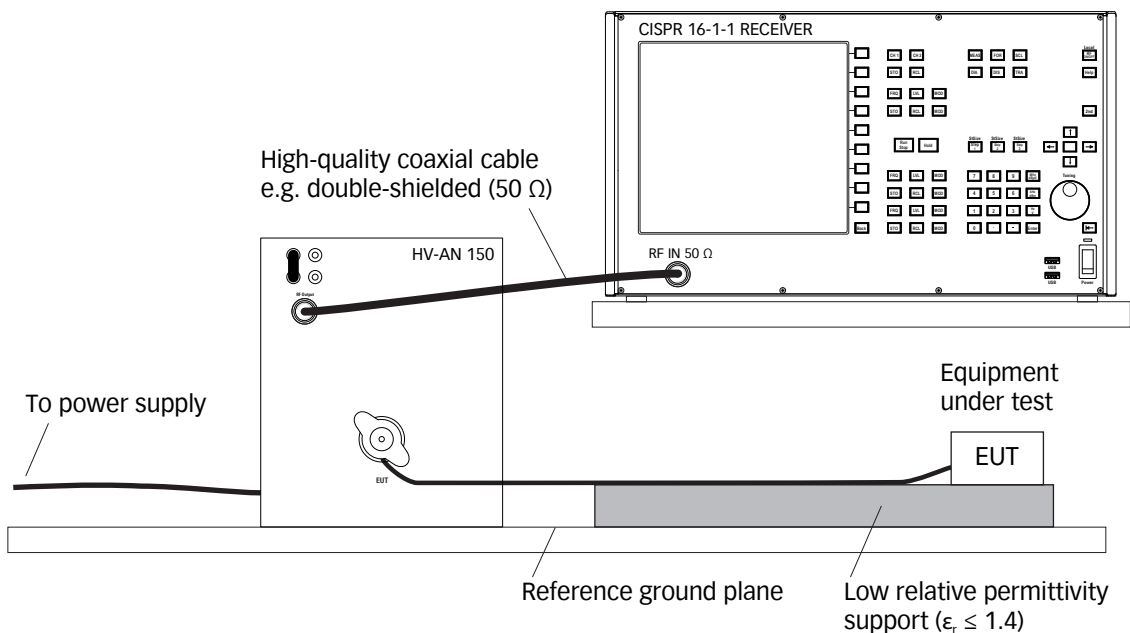

Figure 1: Example measurement set-up

high amplitudes an additional voltage limiter may be required.

The product meets the following standards:

- ISO 11452-4, ISO 11452-1:2015
- CISPR 12 draft Ed. 7.0, CISPR 25,
- ECE No. 10 R05/R06,
- ISO/DTS 7637-4, ISO 7637-2,
- CISPR 16-1-2 (additional decoupling required),
- MIL-STD 461F: Figure A-2, MIL-STD 461G: Figure A-2,
- RTCA DO160G (external 10 μF required)

4. CONSTRUCTION OF THE PRODUCT

4.1. EUT port

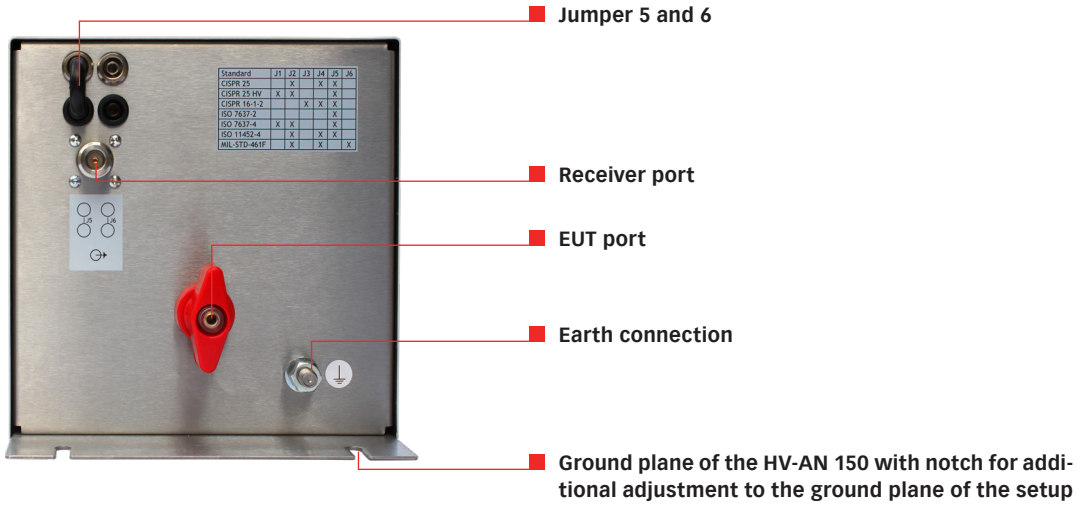

4.2. AE port (connection to power supply for EUT)

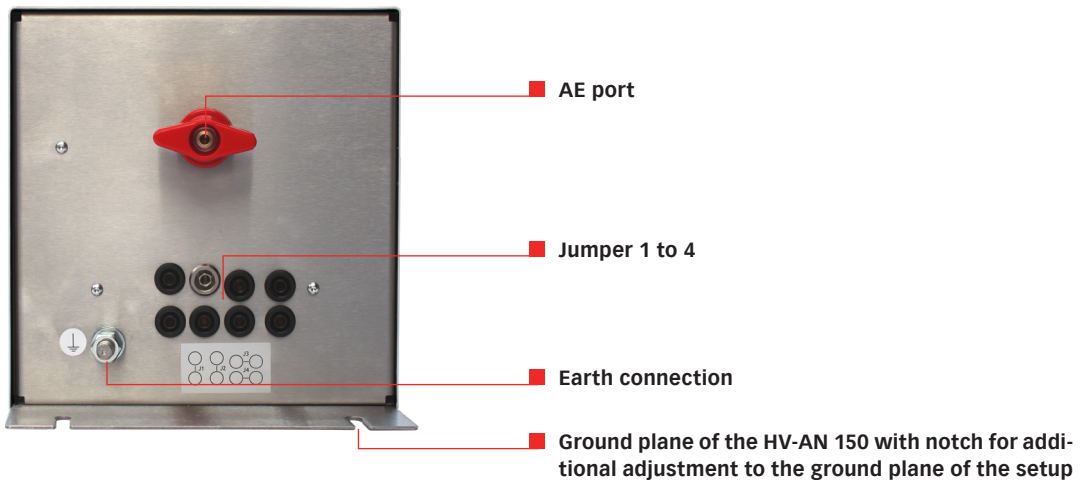

4.3. Jumper settings

Standard	Jumper 1	Jumper 2	Jumper 3	Jumper 4	Jumper 5	Jumper 6
Low voltage part of CISPR 25, ECE No. 10 R06, ISO 11452-1, ISO 11452-4 (2011 or older)	○	●	○	●	●	○
High voltage part of CISPR 25, CISPR 12, ECE No. 10 R05/R06, ISO 11452-1, ISO/DTS 7637-4	●	●	○	○	●	○
CISPR 16-1-2	○	○	●	●	●	○
ISO 7637-2	○	○	○	○	○	●
MIL-STD-461F / G 5 μH LISN type	○	●	○	●	○	●
DO-160G	external 10 μF				○	●

“●” jumper used, connected, “○” no jumper, not connected

4.4. Connection of the external 10 μF to the AE port for application RTCA-DO-160G

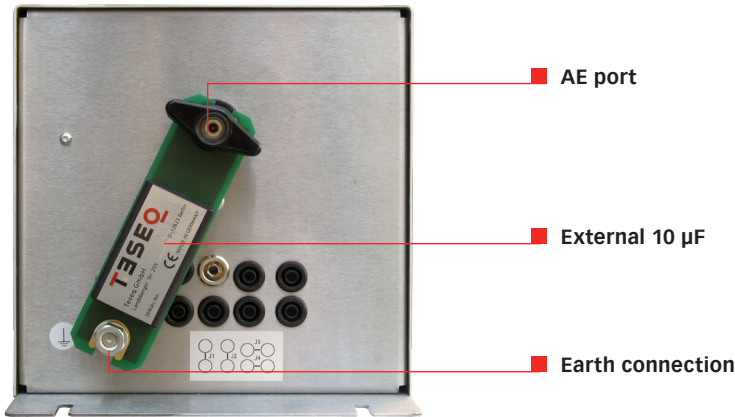

4.5. Equivalent circuits in relation to the jumper settings

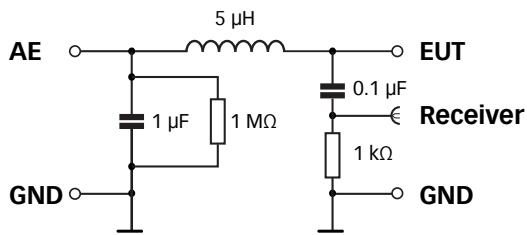

Figure 2: Equivalent circuit according to the low voltage part of: CISPR 25, ECE No. 10 R06, ISO 11452-1 with jumper setting J2, J4 and J5

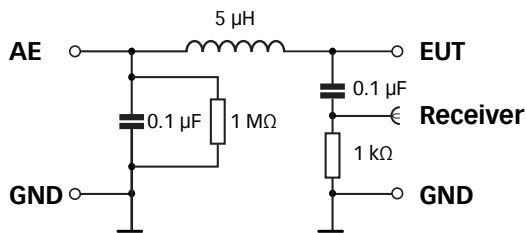

Figure 3: Equivalent circuit according to the high voltage part of: CISPR 25, 12, ECE No. 10 R05/R06, ISO 11452-1, ISO/DTS 7637-4 with jumper setting J1, J2 and J5

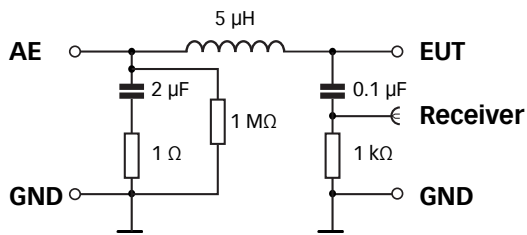

Figure 4: Equivalent circuit according to CISPR 16-1-2 with jumper setting J3, J4 and J5

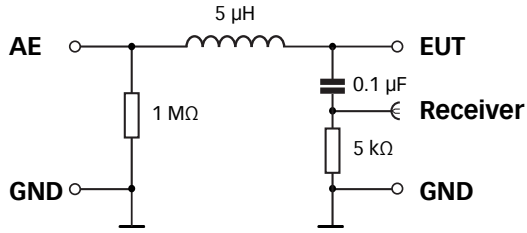

Figure 5: Equivalent circuit according ISO 7637-2 with jumper setting J6

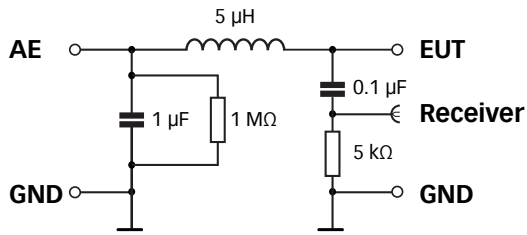

Figure 6: Equivalent circuit according MIL-STD-461F/G 5 μH LISN type with jumper setting J2, J4 and J6

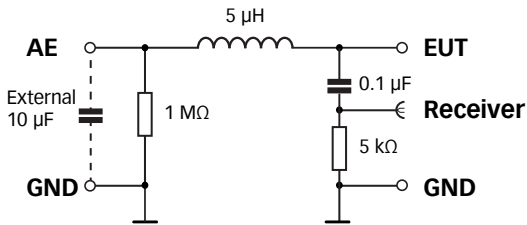
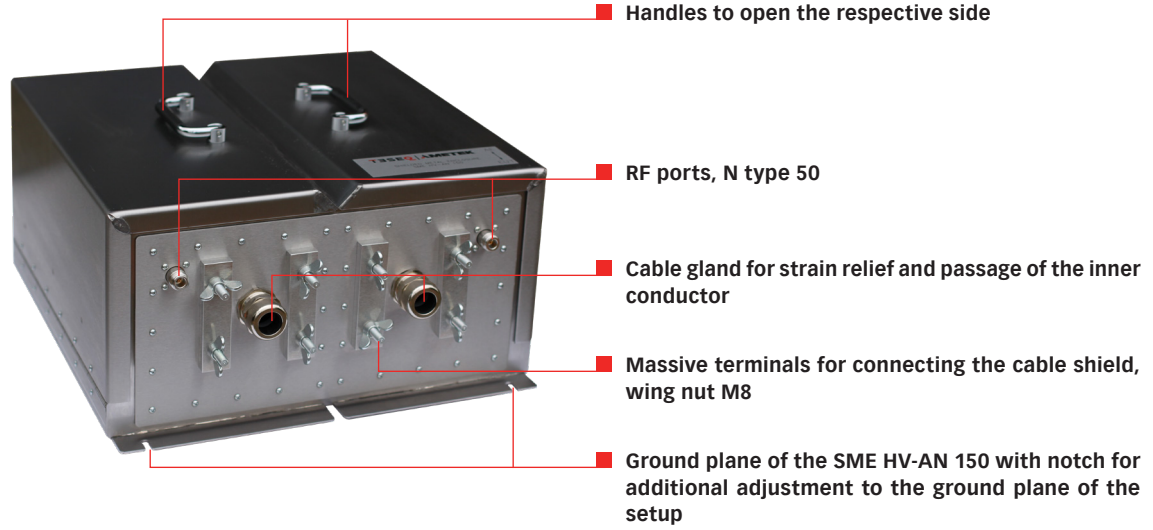

Figure 7: Equivalent circuit according RTCA-DO-160G with external 10 μF and jumper setting J6

5. USE OF THE SHIELDED METAL ENCLOSURE

5.1. View of the closed SME HV-AN 150



5.2. View of the opened SME HV-AN 150



5.3. View to the connectors

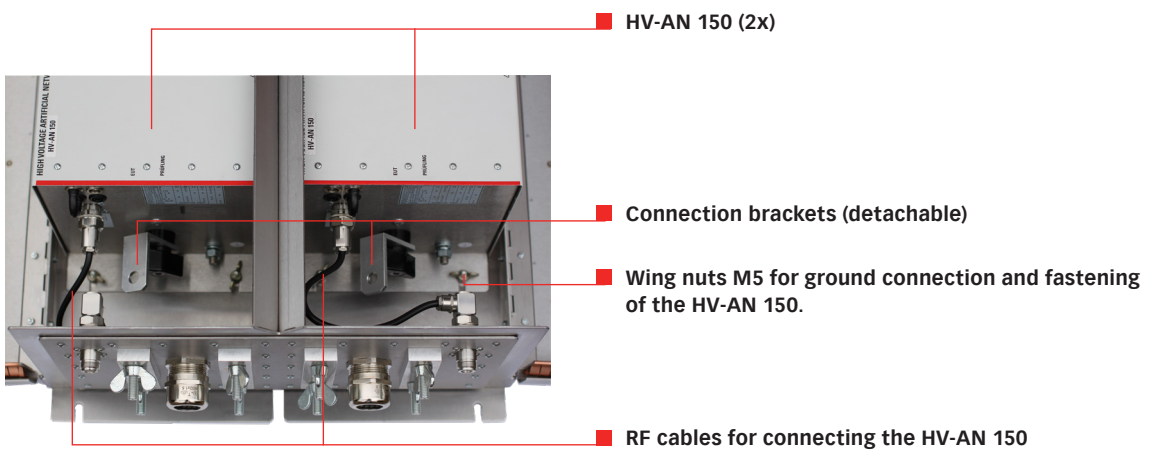

6. TECHNICAL SPECIFICATION HV-AN 150

6.1. Electrical specifications

Standard:	Low voltage part of CISPR 25, ECE No. 10 R06, ISO 11452-4	High voltage part of CISPR 12, 25, ECE No. 10 R05/R06 ISO/DTS 7637-4 ISO 11452-4	ISO 7637-2	CISPR 16-1-2 *1	MIL-STD-461F and G	RTCA/DO-160G
Frequency range:	100 kHz to 100 MHz (max. 200 MHz)	100 kHz to 100 MHz (max. 200 MHz)	100 kHz to 100 MHz	150 kHz to 108 MHz (max. 200 MHz)	150 kHz to 30 MHz (max. 200 MHz)	10 kHz to 400 MHz
Power ratings (EUT/AE)						
AC max. voltage:	350 V	500 V	500 V	350 V	350 V	500 V *2
DC max. voltage:	700 V	1000 V	1000 V	700 V	700 V	1000 V *2
Current max.:	150 A, 60 min	150 A, 60 min	150 A, 60 min	150 A, 60 min	150 A, 60 min	150 A, 60 min
Test voltage:	1500 VDC, 2 s	1500 VDC, 2 s	1500 VDC, 2 s	1500 VDC, 2 s	1500 VDC, 2 s	1500 VDC, 2 s
Simulated impedance (EUT port):	5 μ H 47.6 Ω	5 μ H 47.6 Ω	5 μ H 50 Ω	5 μ H + 1 Ω 47.6 Ω	5 μ H 49.5 Ω	5 μ H 49.5 Ω
Max. Limits:	\pm 20% (magnitude)	\pm 20% (magnitude)	\pm 10% (magnitude)	\pm 20% (magnitude) \pm 11.5 deg (phase)	\pm 20% (magnitude)	\pm 20% (magnitude) 100 kHz to 150 MHz, special limits above and below

*1 The isolation specification of CISPR 16-1-2 requires a dedicated network for this standard only.

*2 dependent on external 10 μ F capacitor

EUT/AE sockets:	butterfly screw for binding posts with flat clamp (bolt diameter 8 mm)
RF socket:	N, 50 Ω
DC resistance (AE/EUT):	< 5 m Ω

6.2. Mechanical specifications

Size (W x H x D):	180 mm x 180 mm x 230 mm
Weight:	approx. 4.2 kg

6.3. Environmental conditions

Operating temperature:	+5°C to + 40°C
Storage temperature:	-20° to + 70°C
Relative humidity:	20% to 80%

7. TECHNICAL SPECIFICATION SME HV-AN 150

Connectors front panel	2 x N (fem)
Weight (empty)	21 kg (appx.)
Weight (with 2x HV-AN 150)	31 kg (appx.)
Dimensions (LxWxH)	480 x 413x 225 mm

Outline dimensions in mm

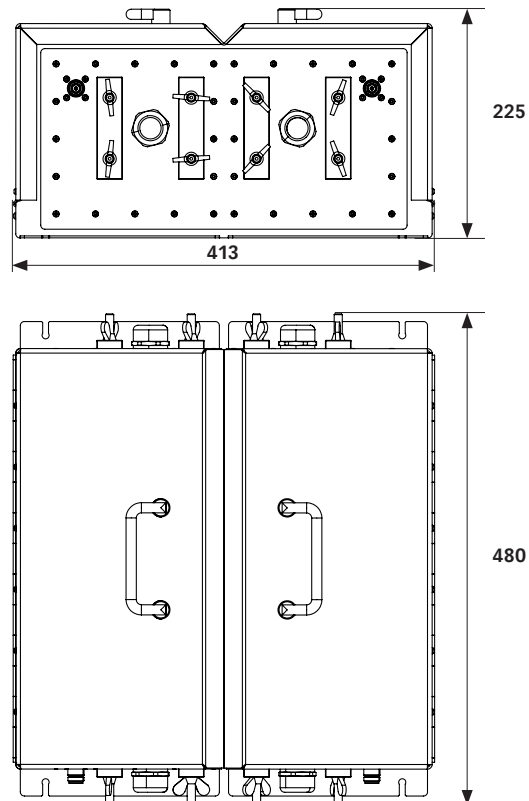

8. MAINTENANCE

8.1. General

The HV-AN 150 needs no special maintenance. The maintenance is limited to the cleaning of the contacts. The life time of the connectors is limited because of the contact durability. Teseq can replace the worn out connectors.

No modifications are to be carried out on the HV-AN 150 and accessories by the user. It is recommended to send the unit to a AMETEK Service Centre once a year for recalibration.

8.2. Cleaning

The cleaning shall be done with dry cloth. If a wet cleaning would become necessary, make sure that no humidity will enter inside of the unit and clean the instrument housing with a damp cloth using a little mild, non-abrasive household cleanser if necessary.

Chemicals must not be used for cleaning purposes

9. DISPOSAL

The unit is constructed that it can be dismantled right down to the component level.

Manufacturer**AMETEK CTS Europe GmbH**

12623 Berlin, Germany
 Landsberger Str. 255
 T +49 30 5659 8835
 F +49 30 5659 8834
 customercare.cts@ametek.com
www.ametek-cts.com

China**AMETEK Commercial Enterprise (Shanghai) Co., Ltd. Beijing Branch**

T +8610 8526 2111
 F +8610 8526 2141
 chinasales.cts@ametek.com

Japan**AMETEK Co., Ltd. Nagoya Office**

T +81 52 709 5501
 cts-japan.sales@ametek.com

Singapore**AMETEK Singapore Pte Ltd**

T +65 6484 2388
 singapore.sales.cts@ametek.com

Taiwan**AMETEK Taiwan Corp. Ltd**

T +886 3 575 0099
 taiwansales.cts@ametek.com

USA**AMETEK CTS US**

T +1 732 417 0501
 Toll free +1 888 417 0501
 usasupport.cts@ametek.com

Germany**AMETEK CTS Europe GmbH**

T +49 2307 26070-0
 customercare.cts@ametek.com

Poland**AMETEK CTS Europe GmbH**

T +48 518 643 512
 infopolska.cts@ametek.com

Switzerland**AMETEK CTS GmbH**

T +41 32 681 40 50
 info.cts@ametek.com

UK**Ametek (GB) Ltd t/a Teseq**

T +44 845 074 0660
 ametekgb.service@ametek.com

To find your local partner within
 Teseq's global network, please go to
www.ametek-cts.com

© February 2021 Teseq®
 Specifications subject to change without notice.
 All trademarks recognized.

AMETEK CTS Europe GmbH is an ISO-registered
 company. Its products are designed and manufac-
 tured under the strict quality requirement of the
 ISO 9001.

This document has been carefully checked.
 However, AMETEK CTS Europe GmbH does not
 assume any liability for errors or inaccuracies.