

**KeyTek**  
**EMCPro PLUS System**  
**Operations Manual**

**Thermo**  
ELECTRON CORPORATION

# **Thermo**

ELECTRON CORPORATION

# **KeyTek EMCPro PLUS System**

**Operations Manual**

**MA-95-053-005-00 REV B**

**Copyright 2004 Thermo Electron Corporation  
All Rights Reserved**

**Thermo Electron Corporation  
One Lowell Research Center  
Lowell, MA 01852-4345  
Phone: 978-275-0800**

**Fax: 978-275-0850 E-mail: [sales.esd@thermo.com](mailto:sales.esd@thermo.com)**

**© 2004 Thermo Electron Corporation All rights reserved**

The copyright protection afforded to Thermo Electron Corporation includes all forms of media material and information including, without limitation, the software\*, generated icons and logos etc. and all associated documentation. This operating manual and associated software contained within may not be duplicated in any way without the express permission of Thermo Electron Corporation.

Printable products of the software such as test reports and graphs, and associated files of the same, are the property of the purchaser and may be subject to their own copyright restrictions.

\*The EMCPro PLUS system software described in this manual may be copied by, strictly for the use of, the purchaser in accordance with the license agreement in the terms and conditions of sale.

**™ Trademark Credits**

EMCPro PLUS System is a registered trademark of Thermo Electron Corporation. IBM is a registered trademark of International Business Machines Corporation. Microsoft Windows and MS-DOS are registered trademarks of Microsoft Corporation.

**Notice**

In no event will Thermo Electron Corporation be liable for any damages, consequential, incidental or indirect (including loss of business profits, business interruption, loss of business information, and the like) arising out of use or inability to use the hardware or software supplied.

The author and publisher of the operating manual make no warranty of any kind, expressed or implied, with regard to the instructions and suggestions contained within. The author and publisher of this operating manual shall not be liable in any event of incidental or consequential damages in connection with, or arising out of, the furnishing, undertaking or use while following verbal or written instructions and suggestions in any interpretation of its contents.

Thermo Electron Corporation products undergo continuous development and the company reserves the right to change their specifications without obligation or prior notification.

**Thermo Electron Corporation, One Lowell Research Center, Lowell, MA 01852-4345 USA Tel: 978-275-0800**

**Fax: 978-275-0850 <http://www.thermo.com/esd>**

# Amendment History

| Issue | Date     | Author | Amendment                                    |
|-------|----------|--------|--|
| A     | 10/22/04 | JFL    | Create for EMCPro PLUS from previous manual. |
| B     | 6/9/06   | JJT    | WEEE Compliance Page #115 added.             |

---

# TABLE OF CONTENTS

## OVERVIEW

|  |           |
|--|-----------|
| <b>Amendment History .....</b>   | <b>iv</b> |
| <b>Product Safety Information.....</b>   | <b>iv</b> |
| <b>Product Safety.....</b>   | <b>1</b>  |
| <b>Surge Testing Guidelines .....</b>  | <b>3</b>  |
| <b>Safety Concerns During Surge Testing .....</b>  | <b>4</b>  |
| <b>Inappropriate Uses .....</b>  | <b>5</b>  |
| <b>Description .....</b>   | <b>6</b>  |
| <b>Installation .....</b>  | <b>7</b>  |
| UNPACKING INSTRUCTIONS .....   | 7         |
| HANDLING, TRANSPORTATION, STORAGE .....  | 7         |
| CABLING AND INTERCONNECTIONS .....   | 8         |
| ELECTRICAL SUPPLY REQUIREMENTS .....   | 12        |
| PHYSICAL ENVIRONMENT.....  | 14        |
| OPERATING LIMITS .....   | 14        |
| STORAGE LIMITS.....  | 14        |
| TEST AREA CONSIDERATIONS AND SITE PREPARATION.....   | 15        |
| SPECIAL CONSIDERATIONS FOR SURGE TESTING .....   | 15        |
| SPECIAL CONSIDERATIONS FOR EFT TESTING.....  | 16        |
| SPECIAL CONSIDERATIONS FOR ESD TESTING .....   | 19        |
| SPECIAL CONSIDERATIONS FOR PULSED MAGNETIC FIELD AND POWER-FREQUENCY MAGNETIC FIELD TESTING... | 19        |
| <b>Introduction .....</b>  | <b>20</b> |
| EMCPro PLUS SYSTEM INTERCONNECTIONS -- ESD AND COMPUTER INTERFACE.....                         | 20        |
| CONNECTION TO THE EQUIPMENT UNDER TEST .....   | 21        |
| USER INTERFACE.....  | 26        |
| PROGRAMMING THE EMCPro PLUS FROM THE FRONT PANEL .....   | 27        |
| <i>Main Menu.....</i>  | 27        |
| <i>Test Menu .....</i>   | 27        |
| <i>Parameter Definition Menu.....</i>  | 28        |
| <i>Run Menu.....</i>   | 29        |
| MAP OF FRONT PANEL MENU STRUCTURE .....  | 33        |
| PROGRAMMING THE EMCPro PLUS FROM A PERSONAL COMPUTER .....                                     | 36        |
| <b>Running Tests .....</b>   | <b>37</b> |
| STANDARDS OVERVIEW .....   | 37        |
| TEST REQUIREMENTS .....  | 38        |
| WRITING A TEST PROCEDURE AND THE TEST REPORT .....   | 38        |
| IEC 1000-4-2 -- ESD TESTING .....  | 40        |
| <i>What is Electrostatic Discharge (ESD) Testing? .....</i>                                    | 40        |
| <i>General Guidelines for ESD Testing .....</i>  | 41        |
| <i>ESD Testing Requirements per IEC 1000-4-2.....</i>  | 42        |
| <i>User-defined ESD Tests.....</i>   | 44        |

---

|   |           |
|---|-----------|
| <i>Preprogrammed IEC Standard ESD Test Sequences</i> .....                            | 44        |
| <i>ESD Waveform Verification</i> .....  | 45        |
| IEC 1000-4-4 -- EFT TESTING .....   | 46        |
| <i>What is Electrical Fast Transients (Burst) Testing?</i> .....                      | 46        |
| <i>General Guidelines for EFT Testing</i> .....                                       | 47        |
| <i>EFT Testing Requirements per IEC 1000-4-4</i> .....                                | 47        |
| <i>User Defined EFT Test</i> .....  | 50        |
| <i>Preprogrammed EFT Test Sequences</i> .....   | 50        |
| <i>EFT Waveform Verification</i> .....  | 51        |
| SURGE TESTING .....   | 52        |
| <i>What is Surge Testing?</i> .....   | 52        |
| <i>General Guidelines for Surge Testing</i> .....                                     | 54        |
| <i>Surge Testing Requirements per IEC 1000-4-5</i> .....                              | 57        |
| <i>User Defined Surge Tests</i> .....   | 59        |
| <i>Preprogrammed IEC Standard Surge Test Sequences</i> .....                          | 61        |
| <i>Surge Waveform Verification</i> .....  | 63        |
| IEC 1000-4-8 .....  | 64        |
| POWER-FREQUENCY MAGNETIC FIELD TESTING .....  | 64        |
| <i>What is Power Frequency Magnetic Field (PFMF) Testing?</i> .....                   | 64        |
| <i>General Guidelines for PFMF Testing</i> .....                                      | 64        |
| <i>PFMF Testing Requirements per IEC 1000-4-8</i> .....                               | 65        |
| <i>User Defined Power Frequency Magnetic Field Test</i> .....                         | 66        |
| <i>Preprogrammed IEC Standard PFMF Immunity Test Sequences</i> .....                  | 66        |
| <i>PFMF Waveform Verification</i> .....   | 66        |
| IEC 1000-4-9 .....  | 67        |
| PULSED MAGNETIC FIELD TESTING.....  | 67        |
| <i>What is PULSED MAGNETIC FIELD (PMF) Testing?</i> .....                             | 67        |
| <i>General Guidelines for PMF Testing</i> .....                                       | 67        |
| <i>PMF Testing Requirements per IEC 1000-4-9</i> .....                                | 68        |
| <i>PMF User Defined Pulsed Magnetic Field Immunity Test</i> .....                     | 69        |
| <i>Preprogrammed IEC Standard Pulsed Magnetic Field Immunity Test Sequences</i> ..... | 69        |
| <i>PMF Waveform Verification</i> .....  | 70        |
| IEC 1000-4-11 .....   | 71        |
| POWER QUALITY FAILURE TESTING .....   | 71        |
| <i>What is Power Quality Failure (PQF) Testing?</i> .....                             | 71        |
| <i>General Guidelines for PQF Testing</i> .....                                       | 71        |
| <i>Testing Requirements per IEC 1000-4-11</i> .....                                   | 72        |
| <i>User Defined PQF Test</i> .....  | 72        |
| <i>Preprogrammed IEC Standard PQF Test Sequences</i> .....                            | 73        |
| <i>Other Preprogrammed Test Sequences -- Line Qualification</i> .....                 | 74        |
| <i>PQF Waveform Verification</i> .....  | 75        |
| <b>Overview of the software</b> .....   | <b>77</b> |
| <b>Basic Operations Under CEWare</b> .....  | <b>78</b> |
| STARTING THE PROGRAM .....  | 78        |
| DEFINING A TEST.....  | 78        |
| RUNNING A TEST .....  | 78        |
| ADDITIONAL OPERATING NOTES .....  | 79        |
| CEMASTER/EMCPro PLUS DIFFERENCES .....  | 80        |
| EMCPro AND EMCPro PLUS DIFFERENCES .....  | 81        |
| CHANGING PROGRAM SETTINGS .....   | 81        |
| <b>CEWare in Detail</b> .....   | <b>83</b> |

---

---

|  |            |
|--|------------|
| <b>Screens and Organization.....</b>             | <b>83</b>  |
| MAIN SCREEN .....                                | 84         |
| NEW SEQUENCE DEFINITION SCREEN.....              | 88         |
| NEW CUSTOM SEQUENCE WIZARD SCREEN .....          | 89         |
| SEQUENCE EDITOR SCREEN.....                      | 90         |
| THE RUN SCREEN .....                             | 95         |
| MENU, TOOLBAR, AND STATUS BAR .....              | 97         |
| <i>Menubar</i> .....                             | 97         |
| <i>Toolbar</i> .....                             | 105        |
| <i>Status Bar</i> .....                          | 105        |
| <i>System Status Bar</i> .....                   | 105        |
| <b>Maintenance.....</b>                          | <b>107</b> |
| SERVICE AND MAINTENANCE ISSUES .....             | 107        |
| ANNUAL CALIBRATION .....                         | 107        |
| FACTORY INSPECTION AND REFURBISHMENT .....       | 107        |
| UPDATING FIRMWARE.....                           | 107        |
| UPGRADING HARDWARE OPTIONS .....                 | 107        |
| DECOMMISSION ISSUES .....                        | 107        |
| <b>Troubleshooting.....</b>                      | <b>108</b> |
| SYSTEM MENU .....                                | 108        |
| TROUBLESHOOTING GUIDE .....                      | 110        |
| ERROR MESSAGES.....                              | 111        |
| <i>Filing a Problem Report</i> .....             | 113        |
| <b>Appendix A Multi-Contact Accessories.....</b> | <b>114</b> |
| <b>WEEE</b> .....                                | <b>115</b> |
| <b>Compliance</b> .....                          | <b>115</b> |

---

The information on IEC requirements -- figures and diagrams, tables and data, and test levels -- are accurate as of the date of printing of this manual. However, the IEC and EN documents are subject to review and change. The information in this manual is intended as a guideline only.

---

---

# Product Safety Information

## Definition of Safety-related materials

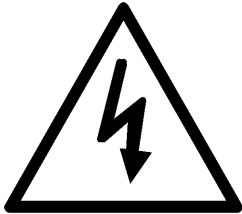

The lightning flash with arrowhead symbol within an equilateral triangle is intended to alert the user of the presence of uninsulated *dangerous voltages* within the product enclosures, and of voltages upon output connectors, that may be of sufficient magnitude to constitute a risk of electric shock to persons.



The exclamation mark within an equilateral triangle is intended to alert the user of the presence of important operating and maintenance (servicing) instructions in the literature accompanying the product.

## Cautions and Warnings

**-CAUTION-**  
**RISK OF ELECTRIC SHOCK**  
**DO NOT OPEN**

TO REDUCE THE RISK OF SHOCK, DO NOT REMOVE COVER  
NO USER SERVICEABLE PARTS INSIDE  
REFER SERVICING TO QUALIFIED SERVICE PERSONNEL

**WARNING**  
TO PREVENT FIRE OR SHOCK HAZARD,  
DO NOT EXPOSE THIS EQUIPMENT TO RAIN OR MOISTURE



---

# Product Safety

The following safety instructions have been included in compliance with safety standard regulations. Please read them carefully.

- **Read Instructions** -- Read all safety and operating instructions before operating the instrument.
- **Retain Instructions** -- Retain all safety and operating instructions for future reference.
- **Heed Warnings** -- Adhere to all warnings on the instrument and in the operating instructions.
- **Follow Instructions** -- Follow all operating and use instructions.
- **Water and Moisture** -- Do not use the instrument near water.
- **Carts and Stands** -- Use the instrument only with a cart or stand that is recommended or included as part of the **EMCPro PLUS** system by the manufacturer.
- **Wall or Ceiling Mounting** -- Do not mount the instrument on a wall or ceiling.
- **Ventilation** -- The instrument should be situated so that its location or position does not interfere with its proper ventilation. Do not install in a cabinet or in other situations that may impede the flow of air through the ventilation openings.
- **Heat** -- The instrument should be situated away from heat sources such as heat registers or other instruments which produce heat.
- **Power Sources** -- Connect the instrument only to the type of power source described in the operating instructions or as marked on the instrument.
- **Grounding or Polarization** -- Take precautions to insure that the grounding of the instrument is not defeated. Operate only with a grounded power cord.
- **Power Cord Protection** -- Place power supply cords so that they are not likely to be walked on or pinched by items placed on them or against them. Pay particular attention to cords at plugs, convenience receptacles, and the point where they enter and exit the instrument. The cordsets used should be the right-angle cordsets supplied with the unit, to prevent damage to the cordsets when moving the **EMCPro PLUS**.
- **Cleaning** -- Clean the instrument only as recommended by the manufacturer.

- 
- **Non-Use Periods** -- Unplug the power cords of the instrument when it will be left unused for a long period of time.
  - **Lifting and Carrying** -- When moving or installing an **EMCPro PLUS** follow the instructions given in the Installation section of this manual. Moving an **EMCPro PLUS** requires two persons.
  - **Object and Liquid Entry** -- Take care that objects do not fall and that liquids are not spilled into the enclosure through openings.
  - **Defects and Abnormal Stress** -- Whenever it is likely that the normal operation has been impaired, make the equipment inoperable and secure it against further operation. Normal operation is likely to be impaired if, for example, the instrument:
    - Shows visible damage.
    - Fails to perform the intended function.
    - Has been subject to prolonged storage under unfavorable conditions.
    - Has been subjected to severe transport stresses.
  - **Damage Requiring Service** -- The instrument should be serviced by qualified service personnel when:
    - The power supply cord or the plug has been damaged.
    - Objects have fallen or liquid has been spilled into the instrument.
    - The instrument has been exposed to rain.
    - The instrument does not appear to operate normally or exhibits a marked change in performance.
    - The instrument has been dropped, or the enclosure has been damaged.
  - **Sitting or Climbing** -- Do not sit or climb upon the instrument or use it as a step or ladder.

---

# Surge Testing Guidelines

- **DO NOT WORK ALONE.**
- Do not use the equipment in conditions other than reasonable laboratory conditions. There should be no condensing humidity or water standing on the floor or work surfaces; there should not be significant dust or other contamination.
- Ensure that **NO ONE** is touching the equipment under test (EUT) during the test or immediately after the test until AC power to the EUT has been turned off.
- Ensure that there is a **barrier** to act as protection in case the equipment under test explodes. This may happen due to power-follow<sup>1</sup> after a failure. The barrier should be interlocked to prevent surging and to disconnect all AC if the barrier is removed.
- The equipment under test must be surrounded by sufficient **insulating material** to withstand twice the surge voltage. Consider distance to the floor or table and walls if air is the insulating material.
- Ensure that the **proper supply mains** voltages are applied to both Thermo equipment and to the equipment under test, and that the AC branch circuit is capable of supplying the current.
- The ground (protective earth), neutral and phase lines of the AC supply to the equipment under test supply must be connected properly. **Do not defeat the protective earth connection.**
- The ground (protective earth), neutral and phase lines of the AC supply to the Thermo equipment must be connected properly. **Do not defeat the protective earth connection.**
- When surging a powered EUT, the mains supply to the equipment under test must be capable of handling the potential AC fault current (e.g. do not use a UPS to power the EUT).
- Never surge an AC mains line other than through the EUT output connector and the **EMCPro PLUS** internal filter or via a CM-3CD, three-phase coupler.
- Use only equipment which is designed to be safe for the test being performed.
- Do not test in a potentially explosive atmosphere (e.g. where there are gas fumes).
- Never use equipment that is operating in a strange manner, or that shows clear indication of abuse.
- If probes are in use, be sure they are differential probes which have no ground connection to the surged ground or to the equipment under test.

---

<sup>1</sup> Power-follow is a condition where the Surge event causes a low-impedance path which full mains current may then flow through. One example of this is a gas-tube arrester, which maintains a high impedance until a surge event switches it to a low-impedance state; the low-impedance state is maintained until the mains voltage drops below a critical threshold. Similar effects can be seen due to electrical arcs or exploded components.

- 
- The safety socket surge outputs are gold-plated. To ensure that the connectors will not deteriorate over time, always use gold-plated mating connectors. Safety Concerns During Surge Testing

## Safety Concerns During Surge Testing

Surge testing is hazardous. The equipment under test (EUT) can ignite, possibly explosively. Noxious, toxic and sometimes fatal fumes can be generated by the burning equipment. Accumulated gases may ignite explosively (i.e., *flashover*).

In an environment where surge testing takes place, it is absolutely crucial that these minimum safety precautions be taken:

- Surge testing should be performed only by properly trained test personnel who are experienced in conducting such tests, or be observed and supervised by such experienced personnel. No person subject to heart or neurological conditions should be allowed to conduct surge tests. Persons with pacemakers should not be allowed in or near the area where testing is conducted.
- Never leave a procedure or a test setup unattended.
- All personnel working in the area must be shielded with appropriate eye protection, body protection and electrical protection. They should not be allowed to work in a direct line of a possible explosion of the equipment under test.
- The test area should be a clear and unobstructed environment dedicated to such tests.
- The test area should be equipped with ventilating hoods and blowers to remove gases that may be caused by exploding or burning components.
- The test area should have nonflammable walls and floors plus shielding to contain exploding parts and flames.
- There must be fire extinguishers certified for use in electrical and chemical fires readily available at the test site. **DO NOT USE WATER TO EXTINGUISH AN ELECTRICAL FIRE.**
- All flammable materials and debris must be outside the test area, and the area must be well marked, preferably by physical barriers, to prevent accidental intervention by non-test personnel while a test is in progress.

---

## Inappropriate Uses

The **EMCPro PLUS** must be kept within the specified environmental limits of the operating requirements. This includes not using it in condensing humidity.

The unit must not be operated by wearers of electronic life-support equipment. Personnel with pace-makers, heart problems, nervous disorders, and similar problems should not be allowed to operate the **EMCPro PLUS** or be present during ESD testing.

The ESD probe is capable of giving an unpleasant shock -- it is not intended for use as a shock prod, "cattle prod", or as any device designed to shock people or animals.

There are no User Serviceable parts inside; do not remove covers.

---

## Description

The **EMCPro PLUS** is an advanced EMC immunity test system developed by Thermo in response to manufacturers' demands for a mid-range, low cost, multi-capability test system. The **EMCPro PLUS** is easily configured to meet today's immunity standards required for CE Marking and compliance requirements. In addition, **EMCPro PLUS** capabilities go well beyond the required test levels for the CE Mark.

The **EMCPro PLUS** performs compliance level testing requirements for IEC, UL, ANSI, ETSI and beyond. The **EMCPro PLUS** allows users to perform compliance testing to the following standards:

|               |                                       |                             |
|---------------|---------------------------------------|-----------------------------|
| IEC 1000-4-2  | ESD                                   | UL 864                      |
| IEC 1000-4-4  | EFT                                   | ANSI/IEEE C62.41            |
| IEC 1000-4-5  | Combination and Telecom<br>Wave Surge | EN 50082-1<br>EN-50082-2    |
| IEC 1000-4-8  | Power Frequency Magnetic<br>Fields    | CCITT K17, K20, K21<br>ETSI |
| IEC 1000-4-9  | Pulse Magnetic Fields                 | UL 1449                     |
| IEC 1000-4-11 | Dips and Interrupts                   |                             |
| IEC 1000-4-12 | 100kHz Ring Wave                      |                             |

Users may operate the **EMCPro PLUS** via Thermo's easy to use Windows-based PC software, **CEWare**, or from the front panel. **CEWare** provides simple, straight forward pre-programmed test sequences ideal for the novice user; yet is sophisticated enough to allow an advanced user to develop and save custom test sequences for future testing.

Users may configure the **EMCPro PLUS** from a single test capability to up to seven capabilities in a single unit. When test requirements change, or as standards evolve, upgrading is a simple matter of adding appropriate options or accessories offered by Thermo to their current **EMCPro PLUS**.

One System, One Vendor, One Solution.

The **EMCPro PLUS** system offers the highest test levels and the widest selection of testing capabilities in a low-cost complete system solution.

---

# Installation

## Unpacking Instructions

### **EMCPro PLUS Assembly**

The **EMCPro PLUS** requires two people for unpacking. Check the packaging materials and follow any special unpacking instructions shipped with your unit. The **EMCPro PLUS** comes fully assembled.

Save all shipping materials (shipping boxes, foam pieces, bags, and special instructions) for possible future shipments. The original shipping materials must be used whenever the **EMCPro PLUS** is returned for calibration or service.

Carefully check all shipping materials for accessories which may be packaged with the **EMCPro PLUS**.

### **Computer Assembly**

If your system includes a computer: Unpack the computer and accessories. Verify that the voltage settings of the computer and monitor match your mains voltage.

## Handling, Transportation, Storage

Save all shipping materials (shipping boxes, foam pieces, bags, and special instructions) for possible future shipments.

The **EMCPro PLUS** requires two people for unpacking. Follow the instructions in the **INSTALLATION** section of this manual and any special instructions shipped with the unit.

Issues related to transportation of **EMCPro PLUS** models are identical to those for installation; the weight of the unit requires that two people help in packing and movement. When packing the unit for transportation the original shipping materials should be used, or new materials of equivalent strength and durability.

An optional transport case -- **PRO-CASE** -- is available for the unit.

For long storage intervals, unplug the power cords of the instrument and cover the instrument to protect from dust and liquid spills.

---

## Cabling and Interconnections

The **EMCPro PLUS** has two AC Mains cordsets which plug into the rear of the unit. One, the Systems Power input, powers the circuitry of the **EMCPro PLUS**. The second, the EUT Power input, powers the front panel mains connector and the Equipment Under Test. The cordsets used should be the right-angle cordsets supplied with the unit to prevent damage to the cordsets when moving the **EMCPro PLUS**.

The FiberCom option connects the **EMCPro PLUS** to an external computer running the **EMCPro PLUS** application software under Windows™ 3.x or Windows-95™. The FiberCom option (CM-SW) includes a small module, the FC-11, a short RS-232 cable with a 9-pin D-shell connector, and a fiberoptic cable with a duplex modular connector. The RS-232 connector connects to your computer. The fiberoptic cable connects to the **EMCPro PLUS** front panel; this connector is polarized and can only be inserted in one orientation: with the small tab on the connector facing right. Do not force the connector. The FiberCom option derives power from the RS-232 port of the computer -- no external power source is required.<sup>2</sup>

The optional ESD probe connector attaches to the front panel. This connector is polarized and can only be inserted in one orientation: align the flat of the connector plug with the flat of the front panel opening. Do not force the connector.

### Direct Current Power to EUT

The **EMCPro PLUS** can accept a Direct Current (DC) power source at the EUT input and provide it to the EUT output. When connecting to DC it is important to note the assignment of EUT inlet and outlet connectors.

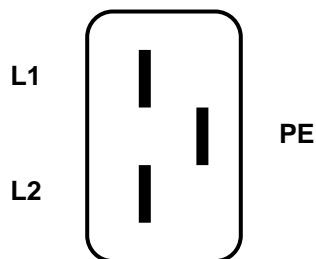

EUT Mains Inlet, Panel Wiring  
The IEC Inlet connector is wired,  
L1 top, L2 bottom, PE center.

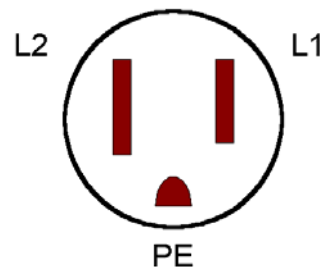

EUT Mains Outlet, Panel Wiring  
Regardless of nationality, the outlet is always  
wired, L2 left, L1 right, PE center.

For DC use L1 and L2 should be used for voltages or voltage and return; the PE connection should be used for return only. Note that PE will be connected to chassis during surge testing.

---

<sup>2</sup> Some computers use a low-power RS-232 driver with a reduced drive voltage. If the FiberCom fails to work with a computer, an external supply should be used [Thermo part #02-701-695-00 (USA) and 62-050-415-00 (European)].



---

## AUX IN Connector to PQF

On the rear panel of the **EMCPro PLUS** are four safety socket outputs for the PQF Aux function.

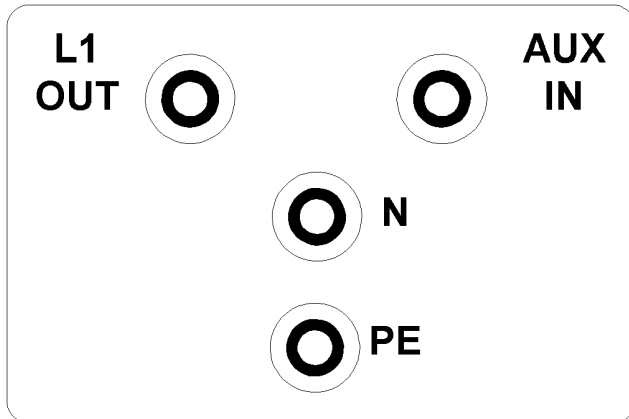

### L1 OUT, N, and PE

These connections are provided to the user, for connection of an external transformer or Variable-transformer, which may be used to derive an AUX IN voltage.

### AUX IN

The AUX IN connection is wired into the PQF circuitry, to allow the user to provide an AC voltage other than the standard, 0%, 40%, or 70% voltages.

When using the Auxiliary input, note the following:

- The L1 and N connections provide the EUT Mains voltage as an output. These connections are internally protected at 16 amperes by a self-resetting thermal breaker.
- L1 and N should not be connected to a source; these terminals are outputs -- not inputs.
- The protection for L1 and N is self-resetting; in the event of a fault these outputs will reset automatically. These lines should not be connected to circuitry which will become a hazard if energized unexpectedly.
- The AUX IN voltage must be AC, within the range of zero to 318Vac, 50/60Hz. Do not connect AUX IN to direct current.
- The AUX IN may be greater than EUT IN, but may not exceed the EUT IN by more than 20%.
- If AUX IN is derived from a source other than the L1 and N connections provided, the user should fuse or protect the AUX IN line for a current less than or equal to the rating of the **EMCPro PLUS** -- 16 amperes.

## Interlock Connector

The optional interlock allows the user to connect a remote switch which, when open, removes all AC and high-voltage from the **EMCPro PLUS** front panel outlets, and disables the ESD head.

A spare interlock connector is provided in the accessories kit for the **EMCPro PLUS**. To use this connector, wire your cable from the connector TIP and RING contacts, and provide a simple switch or contact closure at the other end of the cable.

- 
- The interlock operates from an internal, +5V, 20mA, logic level signal. Do not connect the interlock to a power source.
  - Use a cable with voltage rating of twice the voltage rating of your EUT.
  - Route the interlock cable away from the EUT output and the EUT.
  - DO NOT connect the interlock within the EUT, or to circuitry tied to the EUT.
  - DO NOT use a momentary switch to control the interlock. It is latched, internally, but a momentary switch may not be open long enough to activate the latch.

### Stop Test Input Connector

A coax connector is provided on the front panel to allow remote interruption of an **EMCPro PLUS** test. This connector is internally connected to a 5 volt reference; if this connection is shorted -- coax center connector to shield -- during a test, the **EMCPro PLUS** will treat this event the same as if the STOP button is pressed -- halting the present test. If remote logging is enabled, this event will be logged as a user interruption of the test. While this connection is shorted, the **EMCPro PLUS** cannot be programmed and no test can be started. The minimum duration of the short must exceed 0.15 second.



#### CAUTION

You should not connect a voltage source or generator to the Stop Test Input Connector; doing so may damage the **EMCPro PLUS**

---

### Voltage and Current Monitor Connectors

Two coax connectors are provided on the front panel to monitor surge voltage and current, or mains voltage and current via external equipment (e.g. oscilloscopes or voltmeters). The mode of these outputs, and the voltage scaling, changes with the settings of the **EMCPro PLUS**.



#### CAUTION

You should not connect a voltage source or generator to the IMon or Vmon connectors; doing so may damage the **EMCPro PLUS**

---

### PQF Synchronization Connector

A coax connector is provided on the front panel to allow synchronization of external equipment (e.g. oscilloscopes) with the PQF event. This connector will output a 5 volt pulse at the start of a PQF event, with the pulse duration equal to the duration of the PQF event.



#### CAUTION

You should not connect a voltage source or generator to the PQF Synchronization Connector; doing so may damage the **EMCPro PLUS**

---

### Capacitive Clamp Cable

A 1 meter long stereo phono plug cable and a 1 meter HN-coaxial cable are provided with the **CM-CCL**, and **CM-CCLC** options. The coax cable is screwed onto the **EMCPro PLUS** coax output, and to either end of the **CM-CCL** or cable clamp. The unused coaxial connector on the opposite

---

end of the cable clamp should be left unterminated, or can be used with an optional, coaxial probe to monitor the delivered voltage.

The CM-CCLC cable clamp includes an interlocked safety cover. By connecting the stereo phono plug cable between **EMCPro PLUS** and either end of the cable clamp, the **EMCPro PLUS** will operate only if the cover of the cable clamp is properly seated. The unused interlock jack on the opposite end of the cable clamp can be used to wire to additional interlock switches.

### **I/O and Telecommunication Cables**

The Combination Surge wave and Ring wave can be connected to I/O communication lines (unbalanced datalines) using the optional **CM-I/OCD** coupler and cable. The cable is connected between the white and grey safety sockets of the **EMCPro PLUS** (labeled 1.2/50) and the white and gray safety sockets of the **CM-I/OCD**.

The optional 10/700us wave can be connected to telecommunication lines (balanced datalines) using the optional **CM-TELCOM** coupler and cable. The cable is connected between the white and gray safety sockets of the **EMCPro PLUS** (labeled 10/700) and the white and gray safety sockets of the **CM-TELCOM**.

### **CM-3CD Cables -- Connections to Three-phase Mains**

The Combination Surge wave (and optional Ring wave) can be connected to three-phase mains for Surge and EFT testing using the optional **CM-3CD** coupler and cable. The Surge cable is connected between the white and gray safety sockets of the **EMCPro PLUS** (labeled 1.2/50) and the white and gray safety sockets of the **CM-3CD**. The EFT cable is connected between the HN-coax connector of the **EMCPro PLUS** and the HN-coax connector of the **CM-3CD**.



#### **CAUTIONS**

**Do not connect the CM-3CD cables to the Telecom wave (labeled 10x700) safety sockets. Do not attempt to run Diagnostic tests or Power Frequency Magnetic Field tests or Pulsed Magnetic Field tests while connected to a CM-3CD.**

**Damage to the EMCPro PLUS may result!**

**Disconnect the surge cable from both units when not testing.**

---

### **Magnetic Coil Connections**

An **EMCPro PLUS** -to-coil cable is provided with the CM-HCOIL option. The **EMCPro PLUS** -end of the cable is plugged into the front-panel safety sockets labeled "To H-Coil." The coil end of the cable plugs into the sockets on the coil.

### **Other Cables**

The **EMCPro PLUS** accessories kit includes safety socket connectors and an interlock connector, which the user may use to fabricate special test cables. When fabricating cables, always use wire rated for twice the peak, pulse voltage present during testing.

---

## Electrical Supply Requirements

### System Power

The **EMCPro PLUS** will automatically configure for your AC Mains voltage, choosing one of two voltage ranges:

100 - 120 Vac, 50/60 Hz

220 - 240 Vac, 50/60 Hz

### EUT Power

The **EMCPro PLUS**, EUT power inlet can accept input voltages from 50 - 240 Vac, 50/60 Hz.

**HOWEVER**, the rating of the **EMCPro PLUS** is limited by the EUT mains connector rating, as follows:

|              |              |
|--------------|--------------|
| PRO-BASE-USA | 15A, 120 Vac |
| PRO-BASE-BRI | 13A, 250 Vac |
| PRO-BASE-EUR | 16A, 250 Vac |

The AC power source for the EUT must have adequate capacity for full power-follow<sup>3</sup> in the event that testing causes an equipment failure. Using a supply without sufficient capacity may result in a failure being masked.

Acceptable power sources include:

- A dedicated branch circuit.
- The dedicated output of a motor-generator (MG) set.
- The output of a properly installed isolation transformer.

### Use of the **EMCPro PLUS** with Ground-Fault Interrupters (GFI)

Problems may result when using the **EMCPro PLUS** on AC mains protected by Ground-Fault Interrupters (GFIs). Surging the EUT, with a coupling mode to PE (L1-PE, L2-PE, or L1&L2-PE) will cause the GFI to trip, causing an unexpected loss of AC power to the EUT.

The problem is due to the coupling network mandated by IEC 1000-4-5; this network connects the surge generator to the AC mains during the surge pulse, and creates a short pulse of mains current in PE, tripping the GFI. This problem only occurs during Surge events with a PE coupling mode selected.

---

<sup>3</sup> Power-follow is a condition where the Surge event causes a low-impedance path which full mains current may then flow through. One example of this is a gas-tube arrestor, which maintains a high impedance until a surge event switches it to a low-impedance state; the low-impedance state is maintained until the mains voltage drops below a critical threshold. Similar effects can be seen due to electrical arcs or exploded components.

---

There are two solutions to this problem:

- The first solution is to power the EUT from a source that does not have a GFI device installed. This solution may not be practical in some locations due to building codes or safety regulations.
- The second solution is to install an isolation transformer between the AC mains and **EMCPro PLUS**. The isolation transformer should be rated for *at least* 1920VA for 120VAC mains, or 3840VA for 220/240VAC mains. The transformer should be wired as diagrammed below.

Note that L2 - Neutral - is bonded back to PE at the output of the transformer.

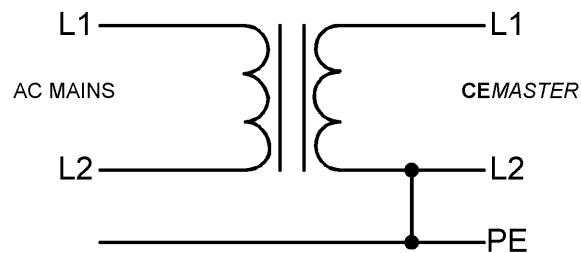

Proper Connection of an Isolation Transformer

#### **Note**

*A solid-state regulated line source such as an un-interruptible power supply (UPS) or a power frequency amplifier will generally not have the instantaneous capacity or full power-follow required for Surge and PQF testing, and therefore should not be used as the AC power source for any equipment being tested.*

---

## Physical Environment

**EMCPro PLUS** systems are intended for operation in a laboratory environment protected from excess dust, humidity, and temperature.

- No condensing humidity or standing water on the floor or work surfaces.
- No significant dust or other contamination.

## Operating limits

|              |                          |
|--------------|--------------------------|
| Temperature: | 15 - 40° C               |
| Humidity:    | 10 - 85%, non-condensing |
| Altitude:    | 8,000 feet max.          |

## Storage limits

|              |                          |
|--------------|--------------------------|
| Temperature: | 0 - 60° C                |
| Humidity:    | 10 - 90%, non-condensing |
| Altitude:    | 8,000 feet max.          |

### Note:

---

If an **EMCPro PLUS** system has been subjected to temperature or humidity outside of the normal operating limits, for a period exceeding four hours, place the system in an environment of the proper temperature and humidity and allow the system to stabilize in that environment for a period of 24 hours; during stabilization, the unit should be unpacked, but not powered nor operating.

The **EMCPro PLUS Pro-ESD** option may require as much as 48 hours stabilization time if the period exceeding the humidity limits exceeds four hours.

---

---

## Test Area Considerations and Site Preparation

Conduct pulsed EMI testing under sound laboratory conditions. Verify the following:

- No condensing humidity or standing water on the floor or work surfaces.
- No significant dust or other contaminants.
- Clear and unobstructed vision.
- Adequate ventilation, including ventilating hoods and blowers to remove gases.
- Nonflammable walls and floors.
- Barriers surrounding the EUT to contain exploding parts and flames.
- Appropriate fire extinguishers for electrical and chemical fires. **DO NOT USE WATER TO EXTINGUISH AN ELECTRICAL FIRE.**
- No flammable materials or debris inside the test area. The area must be well marked, preferably by physical barriers.
- Keep unauthorized personnel out of the area during testing.

Allow at least six inches clearance from the wall or other equipment on both sides of the instrument for proper airflow. The system must be mounted on a level surface.

For EFT testing the **EMCPro PLUS** should be mounted on the floor, on the ground reference plane. For other testing, the **EMCPro PLUS** may be placed on a table that can support the weight of the unit. It may also be placed on a sturdy cart. However, since the unit is heavy, make certain that the instrument and cart combination is stable, and cannot be easily tipped - particularly if the wheels strike a bump on the floor such as the edge of a rug, a pebble or a small piece of hardware.

## Special Considerations for Surge Testing

Pulsed-EMI testing is best done in an area cleared of obstructions. Clearly mark the boundaries of the area.

There is the possibility that the surge may flash over to circuits or metal objects not directly under test, and that components in the equipment being tested may explode or ignite under the stress of the surge test. Whenever possible, enclose the equipment under test within a fireproof and explosion-proof barrier having insulation capable of withstanding at least twice the maximum surge voltage.

Never allow direct line-of-site view of components that may explode or ignite. If visual observation is required, use a robust transparent barrier of suitable thickness for protection.

Pulsed-EMI testing should only be carried out by fully trained personnel who are informed of the hazards of such testing, and who have full control over all of the test equipment in the area.

The **EMCPro PLUS** contains orientation-sensitive components, and will only perform Surge testing when operated in a horizontal position; for accurate, repeatable results the **EMCPro PLUS** should be level, and should be used in a location free from vibration.

---

## Special Considerations for EFT Testing

### NOTE

**While the possibility of component destruction is less of a concern during EFT testing, it should not be ignored.**

EFT testing involves the use of very high frequency pulses. For this reason the testing standards specify the use of a ground reference plane in the area where EFT testing is performed. In addition, the standards specify the minimum and maximum spacing among the various equipment present in the test area.

This device complies with the requirements of the EMC Directive, 89/336/EEC, as stated in the declaration of Conformity. However, EFT test pulses are by nature an interference test and can therefore create a possible source of disturbance to other electronic equipment that is not intended for test. This device should be used in an environment free of other equipment that could be affected by these emissions, or in a shielded room.

The floor of the test area is to be covered with copper or aluminum with a minimum thickness of 0.01 inch, which must be bonded to building Protective Earth (PE) ground. In addition, the cabinet of the **EMCPro PLUS** must be directly tied to the ground reference plane. Provision for a mounting bracket is made on the rear and bottom of the **EMCPro PLUS** and the bracket and screws are provided.

Grounding Bracket

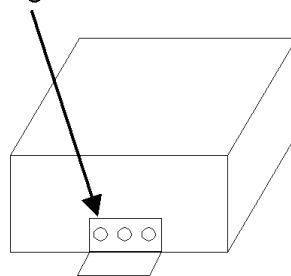

Rear View

EFT Grounding Bracket Location



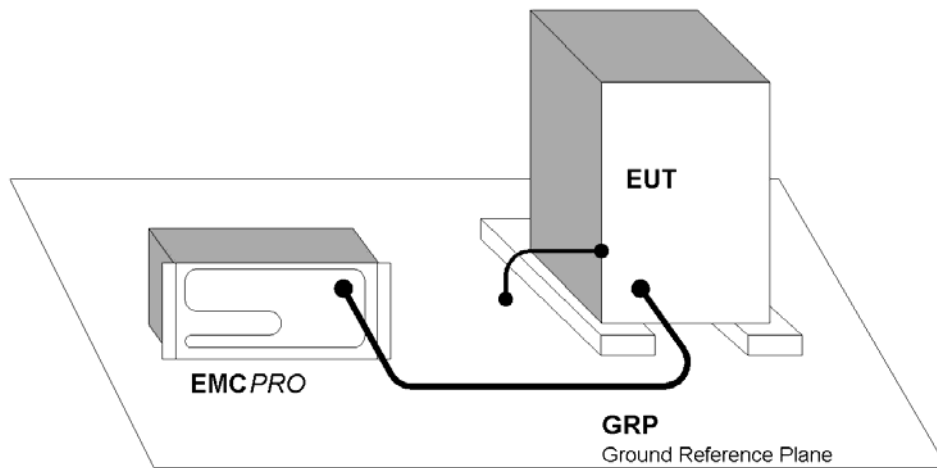

EFT Connection to Equipment Under Test for Floor-standing EUT

When used with table-top equipment, the equipment should be placed on an insulating table of 0.8 meters height.

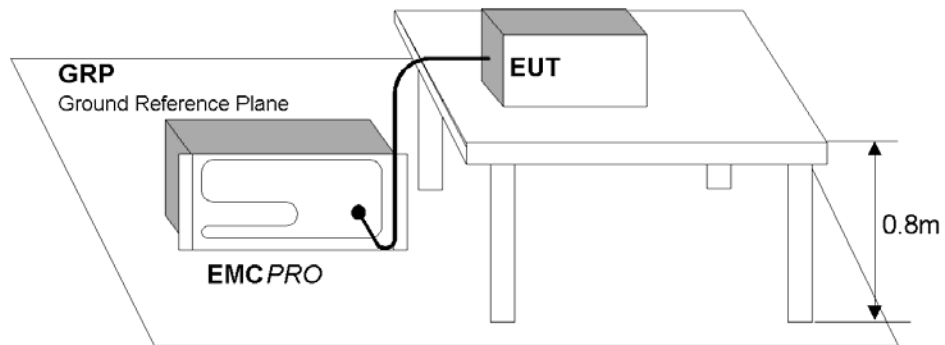

EFT Connection to Equipment Under Test for Table-top EUT

Data and signal cables are tested using the EFT Capacitive Coupling Clamp (CM-CCL). When performing these tests, the EUT and any auxiliary equipment should be powered from the **EMCPro PLUS** EUT output, to provide isolation between the test setup and building power mains. The minimum spacing required between the clamp and the equipment in the test area is shown in the figure below.

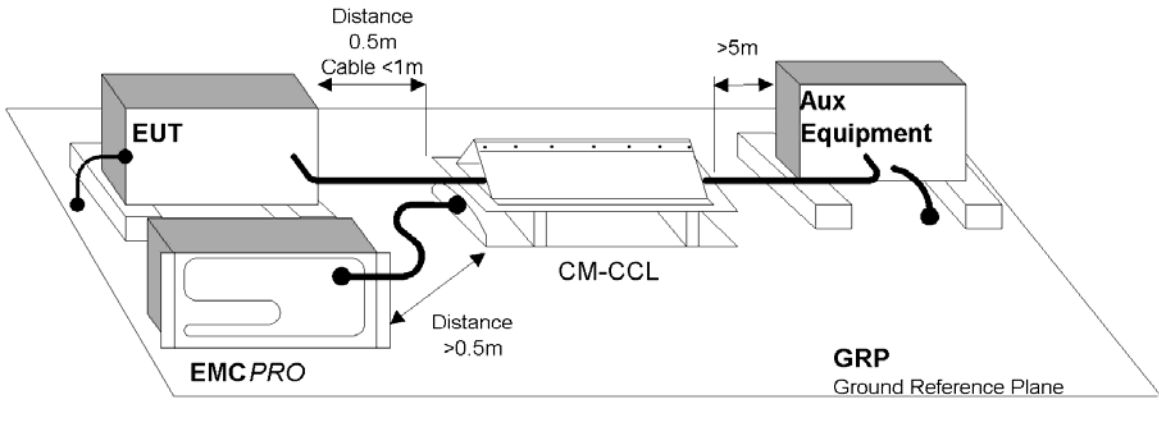

Use of the Capacitive Cable Coupler for EFT Testing

The **EMCPro PLUS** contains orientation-sensitive components, and will only perform EFT testing when operated in a horizontal position; for accurate, repeatable results the **EMCPro PLUS** should be level, and should be used in a location free from vibration.

---

## Special Considerations for ESD Testing

ESD testing involves the use of high-voltage, fast-rising pulses. For this reason the testing standards specify the use of a ground reference plane in the area where ESD testing is performed.

---

This device complies with the requirements of the EMC Directive, 89/336/EEC, as stated in the declaration of Conformity. However, ESD test pulses are by nature an interference test and can therefore create a possible source of disturbance to other electronic equipment that is not intended for test. This device should be used in an environment free of other equipment that could be affected by these emissions, or in a shielded room.

---

IEC 1000-4-2 requires the use of a ground plane, which must be bonded to building Protective Earth (PE) ground. The minimum size of the ground plane is 1 m<sup>2</sup>, the exact size depending on the dimensions of the EUT; the ground plane shall extend beyond the EUT by at least 0.5 m on all sides. The ground plane shall be sheet copper or aluminum of 0.25-mm minimum thickness, or 0.65-mm minimum thickness if another metal is used.

For ESD testing, the **EMCPro PLUS** need not be connected to the ground plane.

The EUT shall be positioned at least 1 m from walls and any metallic structures.

For tabletop equipment, a non-conducting table 0.8-m high is placed on the ground plane. A ground plane (HCP) 1.6-m by 0.8 m will be put on the table, and the EUT and any cables shall be placed on an insulating support 0.5mm thick placed on top of the HCP. The HCP shall connect to the ground reference plane with a resistive cable with two, 470,000-ohm resistors, one resistor at each end of the cable.

## Special Considerations for Pulsed Magnetic Field and Power-Frequency Magnetic Field Testing

IEC 1000-4-8 and IEC 1000-4-9 require the use of a ground plane, which must be bonded to building Protective Earth (PE) ground. The minimum size of the ground plane is 1 m<sup>2</sup>, the exact size depending on the dimensions of the EUT; the ground plane shall extend beyond the EUT by at least 0.5 m on all sides. The ground plane shall be sheet copper or aluminum of 0.25-mm minimum thickness, or 0.65-mm minimum thickness if another metal is used.

For Magnetic Field testing, the **EMCPro PLUS** need not be connected to the ground plane.

The EUT is placed on the ground reference plane, on an insulating support 0.1-meter thick.

The coil and EUT shall be positioned at least 1 meter from walls and metallic objects.

---

# Introduction

The features of the **EMCPro PLUS** are broken into five, major groups: the System Interconnections, the Equipment-Under-Test Connections, the Monitoring and Control Connections, the Rear-Panel Auxiliary Connections, and the User Interface.

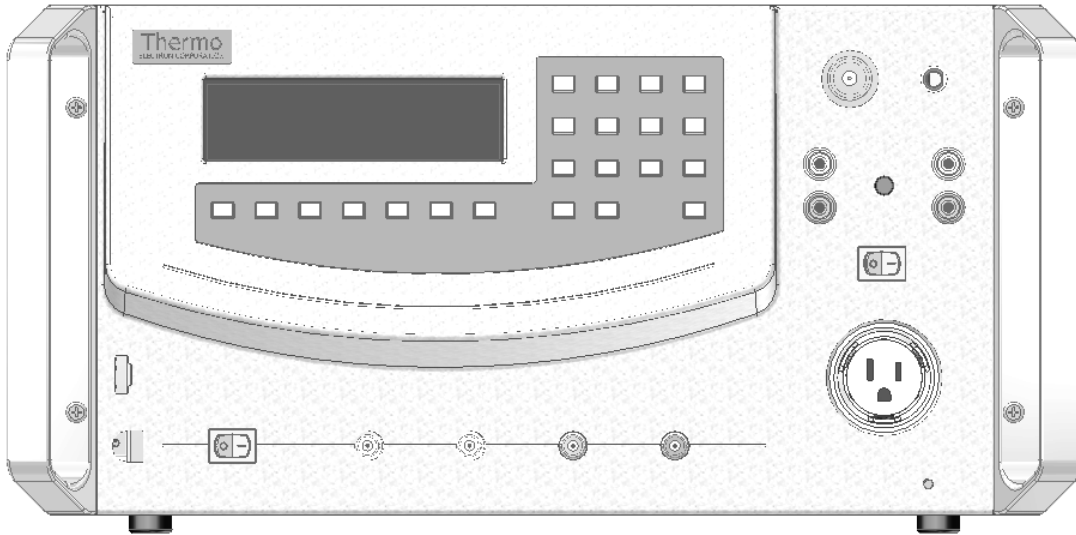

## EMCPro PLUS System Interconnections -- ESD and Computer Interface

FIBERCOM



SYSTEM POWER

ESD OUTPUT

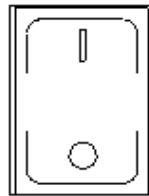
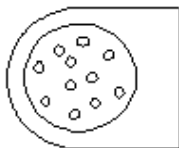

On the left, bottom side of the **EMCPro PLUS** front panel are connectors for the FiberCom serial port, the ESD test probe, and the power switch for the **EMCPro PLUS**. Note that both connectors are polarized. On the FiberCom connector the small tab on the connector faces right. On the ESD probe connector, align the flat of the connector plug with the flat of the front panel opening. Do not force the connectors.

## Connection to the Equipment Under Test

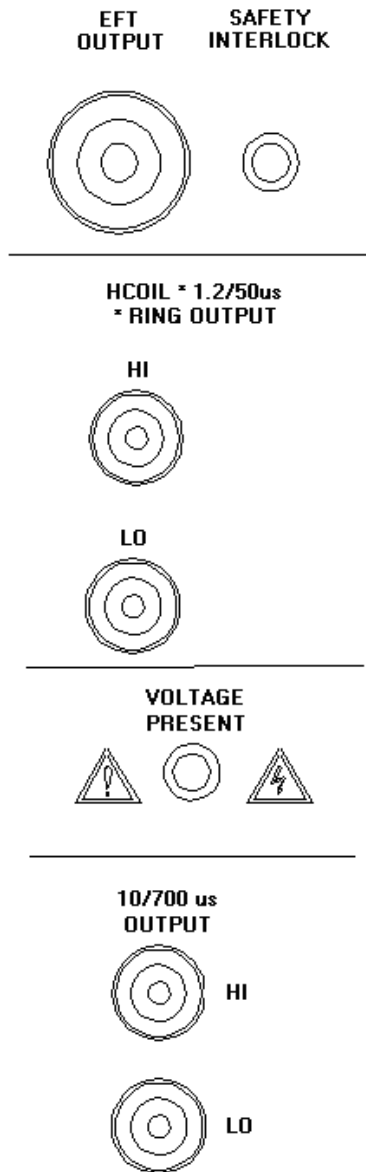

The EFT output coax connects to the Capacitive Cable Clamp or three-phase coupler. This coax is also used for waveform verification.

The Safety Interlock connector allows the user to connect a remote switch which, when open, removes all AC and high-voltage from the **EMCPro PLUS** front panel outlets, and disables the ESD head.

The Safety socket outputs at the right center couple 1.2/50us surge pulses to the magnetic coil or communication lines, and can be used for component testing. These sockets are also used to provide power frequency magnetic field output to a test coil.

The Voltage Present LED is lit when the AC Mains outlet is energized or when high voltage is present.

The other safety socket outputs, next to the display, output the 10/700us telecom wave. This waveform is available for component testing and for coupling to Telecom lines -- it is not for use with AC Mains and AC Mains couplers.

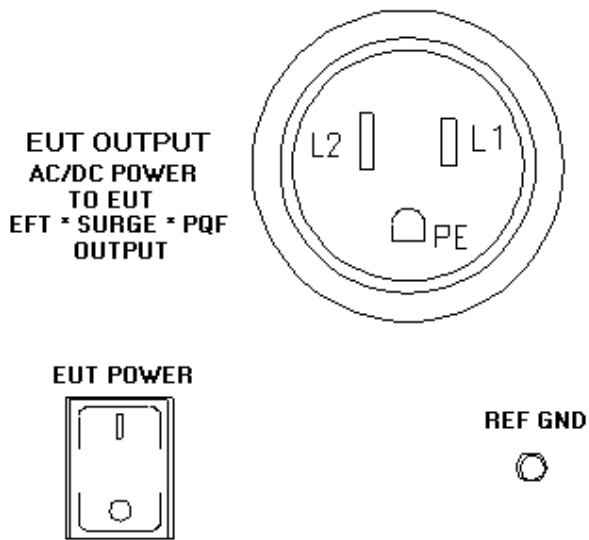

The EUT Power connector provides AC Mains to the Equipment Under Test.

The EUT Power switch energizes the EUT Power connector.

---

For safety, a positive, operator-action is required to energize the EUT; i.e. if the EUT power switch is ON when the **EMCPro PLUS** is first turned on, the switch must be toggled OFF and then ON to energize the EUT Power connector.

---

The Reference Ground Connector is a chassis connection provided for waveform verification of the EFT waveform; it is not used during normal testing.

### Interlock Connector

The optional interlock allows the user to connect a remote switch which, when open, removes all AC and high-voltage from the **EMCPro PLUS** front panel outlets, and disables the ESD head. This is useful to establish a safety perimeter for protection of personnel.

- The interlock operates from an internal, +5V, 20mA, logic level signal. Do not connect the interlock to a power source.
- Route the interlock cable away from the EUT output and the EUT. DO NOT connect the interlock within the EUT, or to circuitry tied to the EUT.
- DO NOT use a momentary switch to control the interlock. A momentary switch may not be open long enough for the **EMCPro PLUS** firmware to latch the interlock event.

---

## Monitoring and Control Connections

Four coax connectors are provided along the bottom, front of the **EMCPro PLUS** for access to the internal monitoring features, and control of tests.

### Stop Test Input Connector

A coax connector is provided on the front panel to allow remote interruption of an **EMCPro PLUS** test. When the coax center connector is shorted to shield the **EMCPro PLUS** will treat this event the same as if the STOP button is pressed -- halting the present test. If remote logging is enabled, this event will be logged as a user interruption of the test. While this connection is shorted, the **EMCPro PLUS** cannot be programmed and no test can be started. The minimum duration of the short must exceed 0.15 second.

This connector is internally connected to a 5-volt reference. You should not connect a voltage source or generator to the Stop Test Input Connector; doing so may damage the **EMCPro PLUS**.

### VMon and IMon -- Voltage and Current Monitor Connectors

Two coax connectors are provided on the front panel to monitor surge voltage and current, or mains voltage and current via external equipment (e.g. oscilloscopes or voltmeters). The mode of these outputs, and the voltage scaling, changes with the settings of the **EMCPro PLUS**.

| Operating Mode                 | Vmon          |            | IMon          |            |
|--------------------------------|---------------|------------|---------------|------------|
|                                | Vmon Source   | Vmon Scale | IMon Source   | IMon-Scale |
| Surge, PMF                     | Surge Out     | 1V / 1000V | Surge Out     | 1V / 200A  |
| Main Menu<br>PQF, PFMF,<br>ESD | EUT Mains Out | 1V / 100V  | EUT Mains Out | 1V / 200A  |
| EFT                            | No output     | No output  | No output     | No output  |

The IMon output has a low impedance of 1 ohm; for reasonable accuracy this output should only be used with measuring instruments with input impedance exceeding 10,000 ohms.

The VMon output -- when measuring surges only -- has an impedance of fifty ohms. Connecting this output to an instrument with fifty ohms input impedance will minimize transmission line effects, and reduce the voltage scaling by a factor of two. The VMon output -- when measuring EUT Mains -- should not be terminated by fifty ohms, and should only be used with instruments with input impedance exceeding 10,000 ohms.

The typical accuracy of all outputs is  $\pm 10\%$ .

Voltage and current monitors are internal to the **EMCPro PLUS**: this is very convenient but results in some limitations. The voltage monitors are affected by the resistance and inductance of internal and external wiring, and by the close proximity to surge discharges exceeding 300 joules of energy.

- 
- The voltage monitor is a good approximation of the open-circuit waveform, but may show distortions when measuring the waveform into an EUT -- or a device -- where low-impedances to ground or non-linear impedance characteristics (MOVs, gastubes, etc.) may cause distortion of the monitor waveform. Such distortions are a characteristic of the voltage monitor -- the actual surge waveform will not show this distortion. Remember also that this monitor is an approximation of the open-circuit waveform internal to the **EMCPro PLUS**: due to resistance and inductance of internal and external wiring, the voltage delivered to the EUT may differ.
  - Noise spikes are typical on the rising edge of the voltage monitor waveform. This noise may make it difficult to measure rise time. These noise spikes are a characteristic of the voltage monitor -- the actual surge waveform will not show this noise.
  - For surge waveform verification, the use of external voltage probes is recommended.
  - The voltage monitor uses high-voltage relays to switch channels; this may cause false triggering of oscilloscopes at the beginning of a test (before the pulse), after a test, and when selecting or deselecting Surge tests from the Main Menu. These effects are caused by relay switching, and are not an indication that pulses are being produced.
  - When performing surge tests (1.2/50, 10/700, Ringwave, PMF) the current monitor will read zero before and after the surge event. During the surge event, the monitor will be switched to the appropriate output (front panel, or EUT AC outlet) and will read the surge current. When surging to the EUT AC outlet, the current monitor will read the surge current, superimposed on the EUT mains current; this may increase or decrease the peak surge current, by the amount of the mains current at the time of the surge.

The current monitors are less affected by the resistance and inductance of internal and external wiring, and give very accurate response.



**CAUTION**

You should not connect a voltage source or generator to the IMon or Vmon connectors; doing so may damage the **EMCPro PLUS**

---

**PQF Synchronization Connector**

A coax connector is provided on the front panel to allow synchronization of external equipment (e.g. oscilloscopes) with the PQF event. This connector will output a 5-volt pulse at the start of a PQF event, with the pulse duration equal to the duration of the PQF event.



**CAUTION**

You should not connect a voltage source or generator to the PQF Synchronization Connector; doing so may damage the **EMCPro PLUS**

---



---

## Rear-Panel Auxiliary Connections

On the rear panel of the **EMCPro PLUS** are four safety socket outputs for the PQF Aux function.

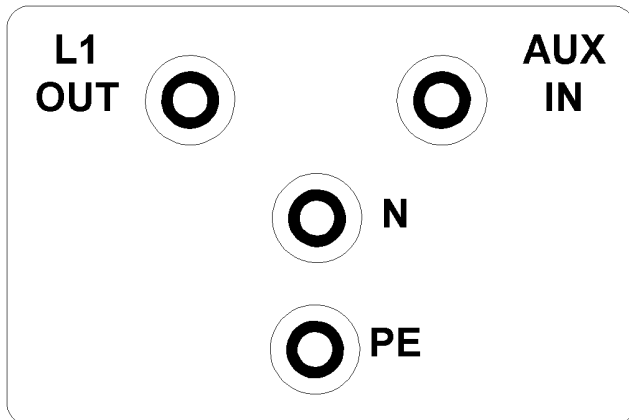

### L1 OUT, N, and PE

These connections are provided to the user, for connection of an external transformer or Variable-transformer, which may be used to derive an AUX IN voltage.

### AUX IN

The AUX IN connection is wired into the PQF circuitry, to allow the user to provide an AC voltage other than the standard, 0%, 40%, or 70% voltages.

When using the Auxillary input, note the following:

- The L1 and N connection provides the EUT Mains voltage as an output. These connections are internally protected at 16 amperes by a self-resetting thermal breaker.
- L1 and N should not be connected to a source; these terminals are outputs -- not inputs.
- The protection for L1 and N is self-resetting; in the event of a fault these outputs will reset automatically. These lines should not be connected to circuitry, which will become a hazard if energized unexpectedly.
- The AUX IN voltage must be AC, within the range of zero to 318Vac, 50/60Hz. Do not connect AUX IN to direct current.
- The AUX IN voltage may exceed the EUT IN, but may not exceed the EUT IN by more than 20%.
- If AUX IN is derived from a source other than the L1 and N connections provided, the user should fuse or protect the AUX IN line for a current less than or equal to the rating of the **EMCPro PLUS** -- 16 amperes.

---

## User Interface

The **EMCPro PLUS** front panel includes a liquid crystal display with seven function keys, and a 15-key keypad to the right of the display.

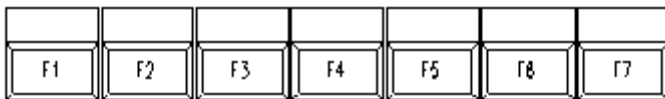
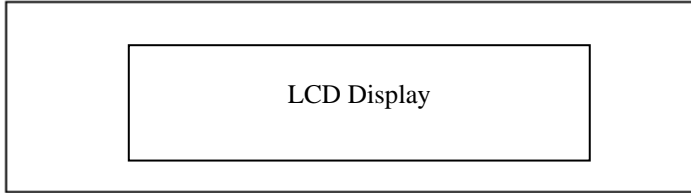

The liquid crystal display and seven function keys provide quick user input. The function keys are mapped to the bottom line of the display. Pressing a function key executes that command.

Typical commands are EXIT (go back one menu), RUN, and scroll through menu selections.

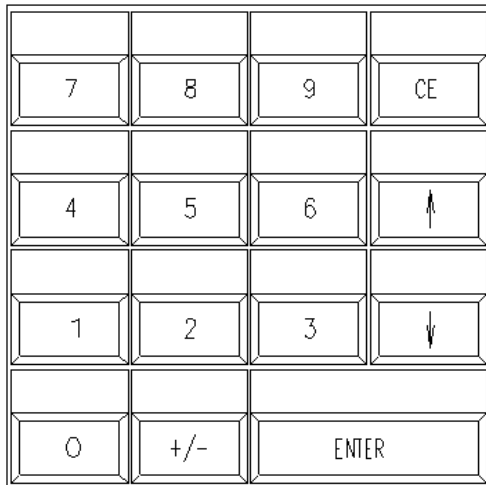

The numeric keypad is used to select menu items and enter numeric data into edit fields. The keys are defined as follows:

- 0 thru 9      Enter numeric data or select menu items
- +/-            Change polarity
- CE             Clear Entry; erase a numeric field
- ENTER         Accept the current input or menu item
- ↑↓             Scroll through selection list boxes, and increment or decrement numeric fields



```

| SRG 1.2/50 |||EUT OFF|
1. User defined      6. Class 2 Full
2. Class 2 Fast      7. Class 3 Full
3. Class 3 Fast      8. Class 4 Full
4. Class 4 Fast
5. Class 1 Full

||  ||  ||  ||  ↑  ||  ↓  ||EXIT

```

### Parameter Definition Menu

After selecting either the User-Defined test option, or a pre-programmed test, a **Parameter Definition Menu** opens. The **Parameter Definition Menu** has edit fields, for waveform, voltage, etc. To change a field you first move the highlight bar to that field, using the function keys. After selecting a field there are different editing steps, depending on the type of field.

- List fields have a limited number of specific values. An example is the line synch field, which can accept "L1" or "RAND". With a list field selected, the value is changed by using the keypad arrow keys to scroll through the options.
- Numeric fields are edited by typing a value at the keypad. The keypad input fills the available field from right to left (If the field allows a decimal place, such as "##.##" and thus a value between 0 and 99.99, to enter a value of 10, press "1", "0", "0", "0"). Press "+/-" after the number to make it negative. Press ENTER or move the highlight bar to another field to accept the value; the value must be accepted before a test can be run.
- Some fields combine Numeric and List fields. When selected, the keypad arrow keys change the list portion (L1,RND) and the keypad number keys replace the numeric value.

When all entries have been made and accepted the test can be started by pressing the F1 key -- the RUN function key. To exit this menu without starting a test, press the F7 key -- the EXIT function key.

```

| SURGE: USER DEF |||EUT OFF|
Waveform ..... 12 Ohm
Voltage ..... +2000 V
Output:Coupling ... MAINS:L1,L2/PE
Phase Sync:Angle .. L1:180 deg
Number of Tests ... 500
Time Between Tests 60 s
RUN ||  ||  ||  ||  ↑  ||  ↓  ||EXIT

```

When a pre-programmed test has been selected, many parameters assume default values and cannot be changed by the user; these fields cannot be selected or highlighted. The fields for these parameters are replaced with an AUTO symbol.



```

|STATUS: INITIALIZING |||||||||||EUT OFF|
Hazardous voltages and emissions are
present by design when this equipment is
operating. Take safety precautions at
all times.
                <PRESS ANY KEY TO CONTINUE>
||      ||      ||      ||      ||      ||

```

At power-up a standard message screen is shown while the system initializes and performs self-tests.

Press any key to show the Main Menu screen below.

```

| MAIN |||||||||||||||||||EUT OFF|
1. EFT/B          5. Pulse Magnetic
2. Surge (1.2/50) 6. Surge (10x700)
3. Power Frequency 7. Surge (Ring)
4. ESD            8. Calibration
5. PQF           10. System Setup
||      ||      ||      ||      ↑      ↓      ||

```

The Main Menu allows selecting a test type; move the highlighted bar using the arrow function keys and press ENTER, or press the number key associated with the test type. As example, press 2 to open the Surge menu.

```

| SRG 1.2/50 |||||||||||||||EUT OFF|
1. User defined   6. Class 2 Full
2. Class 2 Fast   7. Class 3 Full
3. Class 3 Fast   8. Class 4 Full
4. Class 4 Fast
5. Class 1 Full
||      ||      ||      ||      ↑      ↓      ||EXIT

```

The Test Menu offers pre-defined tests to speed setup and a user defined mode for control of every parameter. Press 1 to open the user defined menu.

The EXIT function key moves back one menu level.

```

| SURGE: USER DEF |||||||||||EUT OFF|
Waveform ..... 12 Ohm
Voltage ..... +2000 V
Output:Coupling ... MAINS:L1,L2/PE
Phase Sync:Angle .. L1:180 deg
Number of Tests ... 500
Time Between Tests 60 s
RUN ||      ||      ||      ||      ↑      ↓      ||EXIT

```

Parameter Definition Menus have edit fields, for waveform, voltage, etc. Move the highlighted bar using the function keys to select a field. Edit a field by typing in a number, or use the keypad arrow keys to scroll through a list of options. The RUN function key starts the test.

```

| SURGE: RUN |||||||||||EUT OFF|
                12 Ohm
Status: Charging +2000 V
Time: 37s        MAINS:L1,L2/PE
Test: 1/90      L1:180 deg
Comm: Local     3
                60 s
STOP||      ||PAUSE||      ||      ||

```

The RUN Menu identifies the test and shows status. The screen shows test parameters, and EUT status (ON,OFF), unit status (charging, waiting, firing), test status (time remaining, and test 1 of 90), and communications status (Local, Remote). Stop and Pause keys end the test or causes a temporary hold.

Front Panel Screens showing the Initializing screen and Four Menu Types



The left column shows test information:

Status (charging, running, etc.)  
 Time (secs left in this test step)  
 Comm (local, remote)  
 Test (test n of total tests)

The Status bar indicates the active test; Surge, and the menu; RUN.

EUT status shows the front panel outlet is ON or OFF

```

| SURGE: RUN | ||||| | EUT ON |
|           | ||||| |         |
|           | ||||| |         |
| Status: Charging | +2000 V |
| Time: 37s | MAINS:L1,L2/PE |
| Test: 1/90 | L1:180 deg |
| Comm: Local | 3 |
|           | 60 s |
| STOP|| | || PAUSE|| | || |
  
```

The STOP -F1- function key halts the test

The PAUSE -F3- function key pauses the test. Press F3 again to resume

The right column shows programmed test parameters: waveform, voltage, coupling mode, line synch, number of tests, and time between tests (or length of test).

Definition of the Run Screen Menu



## Map of Front Panel Menu Structure

The next three pages show the structure of the front panel menus.

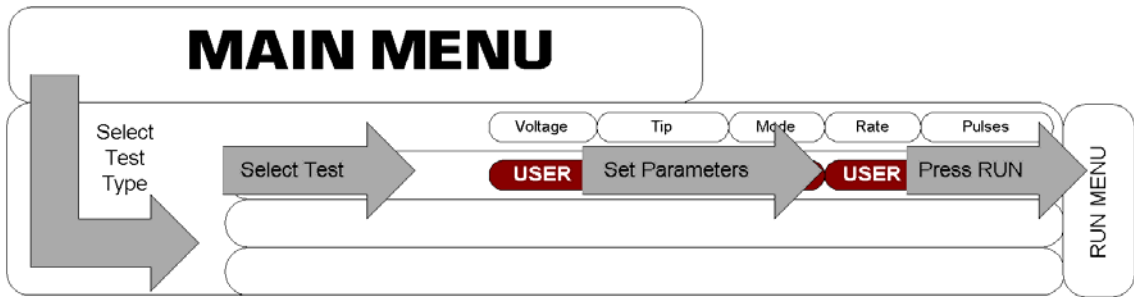

Selection Flow, from Main Menu through Test Menu, Parameter Definition Menu, and Run Menu

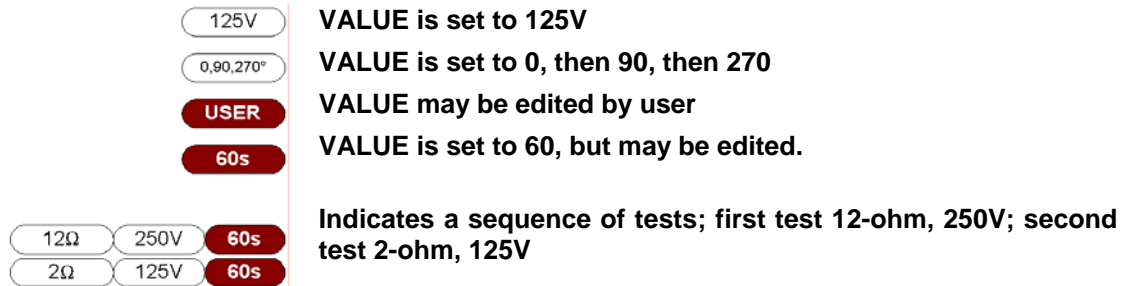

### LEGEND, MAP OF FRONT-PANEL MENUS

# MAIN MENU

|                                     |              |   |         |             |           |       |       |
|-------------------------------------|--------------|---|---------|-------------|-----------|-------|-------|
| 1<br>EFT                            | USER DEFINED | Voltage    frequency    Coupling    Duration                      |         |             |           |       |       |
|                                     | CLASS 1      | ±500V   | 5KHZ    | L1,L2,PE    | 60s       |       |       |
|                                     | CLASS 2      | ±1kV  | 5KHZ    | L1,L2,PE    | 60s       |       |       |
|                                     | CLASS 3      | ±2kV  | 5KHZ    | L1,L2,PE    | 60s       |       |       |
|                                     | CLASS 3      | ±4kV  | 2.5KHZ  | L1,L2,PE    | 60s       |       |       |
| 2<br>SURGE<br>1.2X50us              | USER DEFINED | Waveform    Voltage    Coupling    Synch    Interval    nbr tests |         |             |           |       |       |
|                                     | CLASS 2 FAST | 12Ω   | 1000V   | L1/PE,L2/PE | 0,90,270° | 60s   | 5+,5- |
|                                     |              | 2Ω  | 500V    | L1/L2       | 0,90,270° | 60s   | 5+,5- |
|                                     | CLASS 3 FAST | 12Ω   | 2000V   | L1/PE,L2/PE | 0,90,270° | 60s   | 5+,5- |
|                                     |              | 2Ω  | 1000V   | L1/L2       | 0,90,270° | 60s   | 5+,5- |
|                                     | CLASS 4 FAST | 12Ω   | 4000V   | L1/PE,L2/PE | 0,90,270° | 60s   | 5+,5- |
|                                     |              | 2Ω  | 2000V   | L1/L2       | 0,90,270° | 60s   | 5+,5- |
|                                     | CLASS 1 FULL | 12Ω   | 500V    | L1/PE,L2/PE | 0,90,270° | 60s   | 5+,5- |
|                                     |              | 12Ω   | 500V    | L1/PE,L2/PE | 0,90,270° | 60s   | 5+,5- |
|                                     | CLASS 2 FULL | 12Ω   | 1000V   | L1/PE,L2/PE | 0,90,270° | 60s   | 5+,5- |
|                                     |              | 2Ω  | 500V    | L1/L2       | 0,90,270° | 60s   | 5+,5- |
|                                     |              | 12Ω   | 500V    | L1/PE,L2/PE | 0,90,270° | 60s   | 5+,5- |
|                                     | CLASS 3 FULL | 12Ω   | 500V    | L1/PE,L2/PE | 0,90,270° | 60s   | 5+,5- |
|                                     |              | 12Ω   | 1000V   | L1/PE,L2/PE | 0,90,270° | 60s   | 5+,5- |
|                                     |              | 2Ω  | 500V    | L1/L2       | 0,90,270° | 60s   | 5+,5- |
|                                     |              | 12Ω   | 2000V   | L1/PE,L2/PE | 0,90,270° | 60s   | 5+,5- |
|                                     | CLASS 4 FULL | 2Ω  | 1000V   | L1/L2       | 0,90,270° | 60s   | 5+,5- |
|                                     |              | 12Ω   | 1000V   | L1/PE,L2/PE | 0,90,270° | 60s   | 5+,5- |
|                                     |              | 2Ω  | 500V    | L1/L2       | 0,90,270° | 60s   | 5+,5- |
|                                     |              | 12Ω   | 2000V   | L1/PE,L2/PE | 0,90,270° | 60s   | 5+,5- |
| 2Ω                                  |              | 1000V   | L1/L2   | 0,90,270°   | 60s       | 5+,5- |       |
| 3<br>POWER FREQUENCY MAGNETIC FIELD | USER DEFINED | Coil Factor    Field Strength    Frequency    Duration            |         |             |           |       |       |
| 4<br>ESD                            | USER DEFINED | Voltage    Tip    Mode    Rep Rate    Nbr Pulses                  |         |             |           |       |       |
|                                     | AIR 8kV      | ±8kV  | AIR     | USER        | 1pps      | USER  |       |
|                                     | CONTACT 4kV  | ±4kV  | CON     | USER        | 1pps      | USER  |       |
| 5<br>PQF                            | USER DEFINED | Level    Start Angle    Duration    Interval    Nbr Tests         |         |             |           |       |       |
|                                     | 0% OPEN/5S   | 0%open  | 0°/180° | 5s          | USER      | 3/6   |       |
|                                     | 0% SHORT/5S  | 0%short   | 0°/180° | 5s          | USER      | 3/6   |       |

Map of Front-Panel Menus, Page 1 of 2

|                                 |               |             |                |           |           |          |           |          |
|---------------------------------|---------------|-------------|----------------|-----------|-----------|----------|-----------|----------|
| 5<br>PQF                        | 40% 0.1S      | 40%         | 0°/180°        | 0.1s      | USER      | 3/6      | RUN MENU  |          |
|                                 | 70% 0.01S     | 70%         | 0°/180°        | 0.01s     | USER      | 3/6      |           |          |
|                                 | COMBINATION   | 0%open      | 0°/180°        | 5s        | USER      | 3/6      |           |          |
|                                 |               | 0%short     | 0°/180°        | 5s        | USER      | 3/6      |           |          |
|                                 |               | 40%         | 0°/180°        | 0.1s      | USER      | 3/6      |           |          |
|                                 |               | 70%         | 0°/180°        | 0.01s     | USER      | 3/6      |           |          |
|                                 | Qualify 90°   |             | Qualify 270°   |           |           |          |           |          |
| 6<br>PULSE<br>MAGNETIC<br>FIELD | USER DEFINED  | Coil Factor | Field Strength | Interval  | nbr Tests | RUN MENU |           |          |
|                                 | CLASS 3       | USER        | 100A/m         | USER      | 5         |          |           |          |
|                                 | CLASS 4       | USER        | 300A/m         | USER      | 5         |          |           |          |
|                                 | CLASS 5       | USER        | 1000A/m        | USER      | 5         |          |           |          |
| 7<br>SURGE<br>(10x700)          | USER DEFINED  | Voltage     | Interval       | nbr Tests | RUN MENU  |          |           |          |
|                                 | LEVEL 1 FAST  | 500V        | USER           | 1         |           |          |           |          |
|                                 | LEVEL 2 FAST  | 1000V       | USER           | 1         |           |          |           |          |
|                                 | LEVEL 3 FAST  | 2000V       | USER           | 1         |           |          |           |          |
|                                 | LEVEL 4 FAST  | 4000V       | USER           | 1         |           |          |           |          |
| 8<br>SURGE<br>(Ring-<br>wave)   | USER DEFINED  | Waveform    | Voltage        | Coupling  | Synch     | Interval | nbr tests | RUN MENU |
|                                 | 2kV 200A ANSI | 200A        | 2000V          | 4 MODES   | 0,90,270° | 60s      | 5+,5-     |          |
|                                 | 4kV 200A ANSI | 200A        | 4000V          | 4 MODES   | 0,90,270° | 60s      | 5+,5-     |          |
|                                 | 6kV 200A ANSI | 200A        | 6000V          | 4 MODES   | 0,90,270° | 60s      | 5+,5-     |          |
|                                 | 2kV 500A ANSI | 500A        | 2000V          | 4 MODES   | 0,90,270° | 60s      | 5+,5-     |          |
|                                 | 4kV 500A ANSI | 500A        | 4000V          | 4 MODES   | 0,90,270° | 60s      | 5+,5-     |          |
|                                 | 6kV 500A ANSI | 500A        | 6000V          | 4 MODES   | 0,90,270° | 60s      | 5+,5-     |          |
|                                 | Lev1 200A IEC | 200A        | 500/250V       | 4 MODES   | 0,90,270° | 60s      | 5+,5-     |          |
|                                 | Lev2 200A IEC | 200A        | 1k/500V        | 4 MODES   | 0,90,270° | 60s      | 5+,5-     |          |
|                                 | Lev3 200A IEC | 200A        | 2k/1kV         | 4 MODES   | 0,90,270° | 60s      | 5+,5-     |          |
|                                 | Lev4 200A IEC | 200A        | 4k/2kV         | 4 MODES   | 0,90,270° | 60s      | 5+,5-     |          |
|                                 | Lev1 500A IEC | 500A        | 500/250V       | 4 MODES   | 0,90,270° | 60s      | 5+,5-     |          |
|                                 | Lev2 500A IEC | 500A        | 1k/500V        | 4 MODES   | 0,90,270° | 60s      | 5+,5-     |          |
|                                 | Lev3 500A IEC | 500A        | 2k/1kV         | 4 MODES   | 0,90,270° | 60s      | 5+,5-     |          |
|                                 | Lev4 500A IEC | 500A        | 4k/2kV         | 4 MODES   | 0,90,270° | 60s      | 5+,5-     |          |
| 10<br>SYSTEM                    | PARAMETERS    | DIAGNOSTICS |                |           |           |          |           |          |
|                                 | ACCESS CODE   | VERSIONS    |                |           |           |          |           |          |

The PQF pre-programmed tests are actually duplicated, with alternative versions that time the test by cycles of the power line voltage. The preferred test levels are specified in this manner in the second edition of 61000-4-11.

---

## Programming the EMCPPro PLUS from a Personal Computer

When purchased with the **PRO-SW** option, the **EMCPPro PLUS** may be programmed and controlled from a Personal Computer (PC) running Windows™.

The PC software gives full access to all the features and capabilities of the **EMCPPro PLUS**, including running a single test, running a pre-defined test sequence, and running diagnostics.

In addition, the PC software allows the user to:

- Create tests and easily edit them.
- Chain tests into a test sequence. A test sequence can be constructed from a single test type (e.g. Surge) or can combine test types (e.g. do one Surge test followed by one EFT test, etc.).
- Store and recall tests and test sequences to disk.
- Print or file text descriptions of tests and test sequences (for inclusion in reports).
- Log a test -- print or file what tests are executed.

Full instructions for the software are described in the **CEWare™** section.

---

# Running Tests

## STANDARDS OVERVIEW

The European Union's EMC Directive requires that electronic and electrical products be tested for immunity to both man-made and natural phenomena and to insure that products do not emit unintentional signals that may interfere with the continued, reliable operation of other products.

Compliance with the EMC Directive requires that products be tested in accordance with European Norms, or ENs, issued by CENELEC. These ENs are not developed by CENELEC but are IEC and CISPR standards redesignated as ENs.

There are three types of EMC Publications:

- **Product EMC Standards**
- **Product Family Standards (including Generic Standards)**
- **Basic EMC Publications**

**Product EMC Standards** relate to a particular type of product, system or installation for which specific conditions must be considered. Product EMC Standards include:

- Resistance Welding equipment
- Measuring Relays and Protection equipment

Product Standards have priority over Product Family and Generic Standards; however, where no Product Standard or Product Family Standard exists for a particular product, the relevant Generic Standard will apply.

**Product Family Standards** apply to products of a particular category such as:

- Household appliances and portable tools
- ITE (Information Technology Equipment)
- Audio, video, audio-visual and entertainment lighting control apparatus for professional use

Product Family Standards have priority over Generic Standards; however, where no Product Family EMC Standard exists for a particular product family, the relevant Generic Standard will apply.

**Generic EMC Standards** are a special type of Product Family Standard which apply to products operating in a particular environment for which no dedicated Product or Product Family Standard exists. They specify a set of essential requirements, test procedures and generalized performance criteria applicable to products or systems operating in this environment.

---

The Generic EMC Standards include: **EN 50082-1**, **EN 50082-2**, **EN 50081-1**, and **EN 50081-2** which cover immunity and emissions testing for commercial, residential and light industrial environments, as well as for industrial environments.

**Basic EMC Publications** may be standards or technical reports which, by definition, are NOT dedicated to specific product families, products, systems or installations. They may concern:

- Terminology
- Descriptions of electromagnetic phenomena
- Specification of compatibility levels (NOT compliance levels)
- General requirements for the limitation of emissions
- Recommendations for test levels for immunity
- Measurement techniques
- Descriptions and classification of the environment

Basic EMC Publications include Basic EMC standards such as the IEC 1000-4-X Series, CISPR 22, CISPR 11, and others.

## **TEST REQUIREMENTS**

The Basic EMC Publications (IEC 1000-4-2, IEC 1000-4-4, etc.) set the waveforms, test environment, and measurement techniques. The **EMCPro PLUS** was designed to meet the requirements of these publications.

Test levels are set by the Generic EMC Standards and Product Family Standards. The preprogrammed tests stored in the **EMCPro PLUS** are designed to meet the test levels of:

- EN 50082-1      Generic Immunity, Residential, commercial, and light industrial
- EN 50082-2      Generic Immunity, Industrial

## **WRITING A TEST PROCEDURE AND THE TEST REPORT**

Before starting testing, you should create a test procedure. This should identify which European Norms or other test requirements to which you are testing. This should include the test levels, polarities, and number of tests.

Most of the remainder of a test procedure is set by the Basic EMC Publications (IEC 1000-4-2, IEC 1000-4-4, etc.) which define the test setup and environmental limits, in detail.

The test procedure should also describe how the EUT is setup and connected to test equipment and ancillary equipment. If the EUT involves software, a description of which software and software revisions should be included.

---

An important part of both the test procedure and the test report is to establish how the EUT is exercised during the test. Most test procedures recommend that the EUT be operated in "the most sensitive mode". Preliminary testing will usually be required to determine what the most sensitive mode of operation is, which may vary with configuration, software, and operations performed. Finally, the test procedure should consider what level of disturbances of operation is allowed. Ideally the EUT should operate through testing without disturbance, however there may be disturbances which are considered acceptable, in that they do not result in damage. As an example, the following are four possible levels of system disturbance:

- Normal performance within specification limits;
- Temporary degradation or loss of function which is self-recoverable;
- Temporary degradation or loss of function which requires operator intervention or system reset;
- Degradation or loss of function which is not recoverable due to damage to equipment or components or loss of data.

In no case is it acceptable that the equipment become dangerous or unsafe as a result of testing.

The test report should include the test procedure, the test results, and give an explanation of the results, as required. For acceptance tests, the test report is a required result of testing.

The remainder of this section covers the basic EMC publications in detail; explains the waveforms and testing requirements; and explains how to use the **EMCPro PLUS** to meet the requirements of the Basic EMC Publications.

---

The information on IEC requirements -- figures and diagrams, tables and data, and test levels -- are accurate as of the date of printing of this manual. However, the IEC and EN documents are subject to review and change. The information in this manual is intended as a guideline only.

---

# IEC 1000-4-2 -- ESD Testing

## What is Electrostatic Discharge (ESD) Testing?

These tests relate to equipment, systems, sub-systems, and peripherals which may be involved in static electricity discharges (either from persons or adjacent equipment), owing to environmental and installation conditions, such as relative low humidity, use of low-conductivity (artificial fiber) carpets, vinyl garments, etc.

Two different types of tests can be performed with the ESD head - Contact or Air. Contact discharges are tests in which a sharp metal ESD tip physically touches the EUT. This method is regarded as the most repeatable method, and is the only acceptable method for waveform verification and calibration. Air discharges are tests in which a rounded ESD tip is quickly thrust toward the EUT until an ESD event occurs by "leaping" from the ESD tip to the EUT through the air. This method does not yield as repeatable results, but can be used if a contact discharge cannot be performed for some reason or another.

The ESD waveform is characterized by the current in Contact-mode discharge, as defined in the figure and table below:

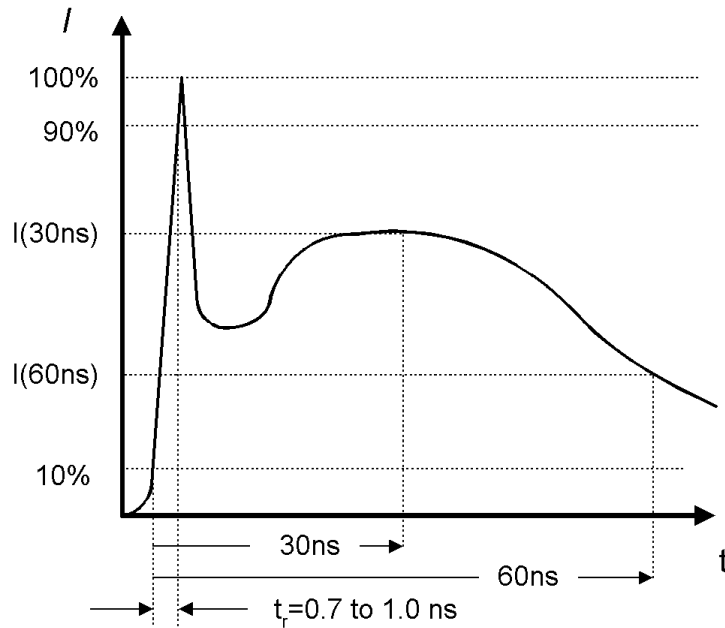

Typical ESD Current Waveform

| Level | Set Voltage | Peak Current ( $\pm 10\%$ ) | Current ( $\pm 30\%$ ) at 30nS | Current ( $\pm 30\%$ ) at 60nS |
|-------|-------------|-----------------------------|--------------------------------|--------------------------------|
| 1     | 2 kV        | 7.5A                        | 4                              | 2                              |
| 2     | 4 kV        | 15 A                        | 8                              | 4                              |
| 3     | 6 kV        | 22.5 A                      | 12                             | 6                              |
| 4     | 8 kV        | 30 A                        | 16                             | 8                              |

Waveform Parameters for ESD Pulse



---

## General Guidelines for ESD Testing

Place the air-discharge or contact-mode output tip into the ESD probe output tip receptacle.

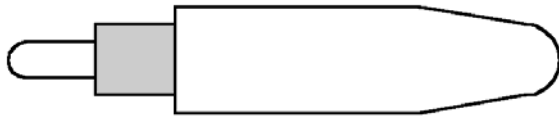

The **TPA-2** probe tip is used for air discharge. The rounded tip of this probe prevents pre-discharge corona (which reduces applied voltage) and ensures most consistent results.



The **TPC-3** probe tip is used for contact discharge. The sharp point of this tip will penetrate surface oxidation and -- where necessary -- paint.

Connect the ESD probe to the **EMCPro PLUS** using the 8-pin DIN cable. Connect the discharge return cable from the ESD probe to ground (an indicator on the ESD probe will light if the discharge return cable is not connected to the ESD probe). The bargraph indicator on the ESD probe is intended as a rough guide of the actual test voltage, and can serve in many applications as a pulse -- discharge -- indicator. The bargraph display is not calibrated, and can be affected by high humidity; for precise readings of probe tip voltage or periodic calibrations, Thermo's **DCA-2**, high-voltage divider should be used.

The ESD probe can be operated in manual triggering mode -- normal -- or automatic triggering mode -- tripod. Normal triggering is intended for handheld applications; in normal mode the probe will fire once for each time the probe button is pressed if the repetition is set to one, or fire continuously at 1pps or 20pps while the button is depressed if the repetition is set higher. Tripod triggering mode is intended for tripod operation; in this mode the probe will start triggering when the probe button is pressed and released and operation continues until either: the test ends, the operator ends the test by pressing the STOP -- F1 function -- key, or the probe button is pressed a second time.

For safety, in all modes of operation, the operator must select a program and press run from the **EMCPro PLUS** front panel or application software, THEN press the probe button to start the test.

For Contact discharges the **TPC-3** contact tip should physically touch the EUT. For Air discharge the rounded, **TPA-2** tip is thrust toward the EUT at a constant rate until an ESD event occurs by "leaping" from the ESD tip to the EUT through the air. The probe is then pulled back - away from the EUT - in preparation for the next test. Some practice is required to obtain consistent results with air discharge.

Certification testing per European Norms uses 1pps for compliance testing. Use 20 pulses per second mode for quick scans to determine the most sensitive areas; then switch to 1pps for compliance testing. In 20 pps mode the pulse-detection and pulse counting features of the

**EMCPro PLUS** are disabled -- after the first pulse event, the ESD probe will free-run at 20pps whether or not there is a discharge.

---

## ESD Testing Requirements per IEC 1000-4-2

Testing to IEC 1000-4-2 has the following requirements:

- Testing takes place in climatic conditions as follows:
  - Ambient temperature: 15 °C to 35 °C
  - Relative Humidity: 30 % to 60 %
  - Atmospheric Pressure: 86 kPa (860 mbar) to 106 kPa (1060 mbar)
- A ground reference plane (GRP) is required.
- The EUT shall be positioned at least 1 m from walls and any metallic structures.
- Positioning of power and signal cables shall be representative of good installation practice.
- The EUT shall be connected to the grounding system, representative of good installation practice; no additional earthing connections are allowed.
- The discharge return cable should, where possible, be placed off the ground reference plane, and should not come closer than 0.2 m to other conductive parts of the test setup.
- Vertical Coupling Planes (VCP) and Horizontal Coupling Planes (HCP) may be used for indirect application of the ESD pulse. These planes shall be constructed from the same material and thickness as the ground plane, and should be connected to the ground plane by a cable with two, 470,000 ohm resistors, one resistor at each end of the cable.
- For tabletop equipment, a non-conducting table 0.8 m high is placed on the ground plane. A ground plane (HCP) 1.6 m by 0.8 m will be put on the table, and the EUT and any cables shall be placed on an insulating support 0.5mm thick placed on top of the HCP. The HCP shall connect to the ground reference plane with a resistive cable as in the previous paragraph.

IEC 1000-4-2 requires the use of a ground plane, which must be bonded to building Protective Earth (PE) ground. The minimum size of the ground plane is 1 m<sup>2</sup>, the exact size depending on the dimensions of the EUT; the ground plane shall extend beyond the EUT by at least 0.5 m on all sides. The ground plane shall be sheet copper or aluminum of 0.25 mm minimum thickness, or 0.65-mm minimum thickness if another metal is used.

For Floor-standing EUT the EUT is placed on a non-conducting mat of 0.1-mm minimum thickness placed on the ground plane. ESD testing may be direct -- applied to the EUT -- or indirect -- applied to the ground plane or to a vertical plane bonded to the ground plane.

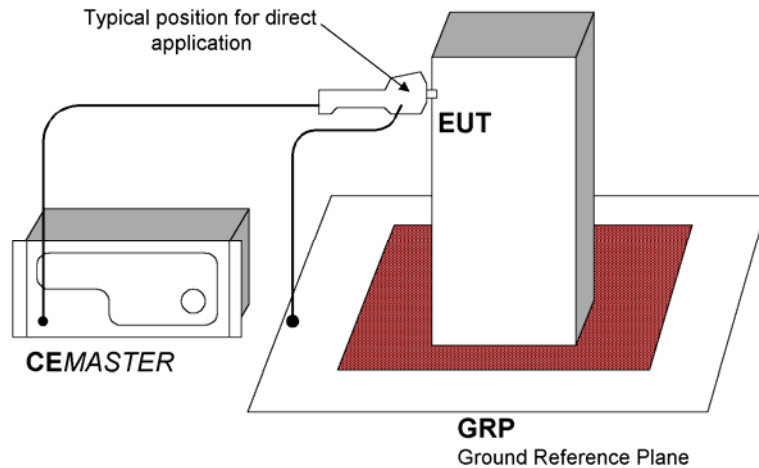

Typical ESD Test Setup for Floor-standing EUT

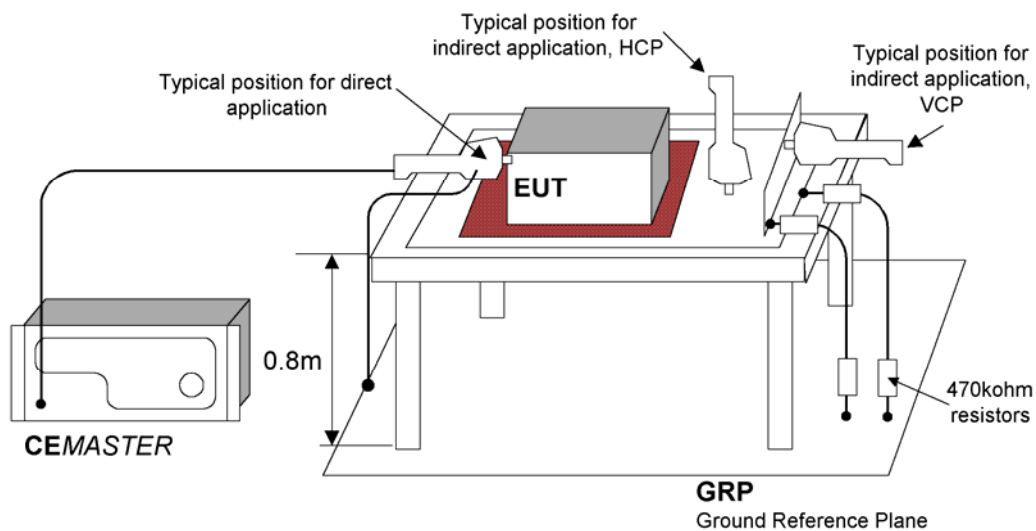

Typical ESD Test Setup for Table-Top EUT

During testing, the EUT is operated in a normal fashion. Compliance testing is typically performed with the EUT continually operating in the most sensitive mode, as determined by preliminary testing.

Pulses are applied to points and surfaces, which are accessible to personnel during normal usage. The voltage is increased from the minimum to the selected test level, in order to determine the threshold of failure (if any). The final test level is set by the product specification and the test class. The test is applied with single discharges, at preselected points. At least ten discharges of the most sensitive polarity shall be applied, and a rest interval of at least one second is recommended (or longer, as required to verify continued operation of the EUT).

The **EMCPro PLUS** supports 1000-4-2 testing to class 3 in Air-discharge mode and class 2 in contact discharge mode. The following table lists the test capabilities of the ESD hardware:

| Class | Peak Voltage<br>kV |     |
|-------|--------------------|-----|
|       | Contact            | Air |
| 1     | 2                  | 2   |
| 2     | 4                  | 4   |
| 3     | N/A                | 8   |

## User-defined ESD Tests

The user-defined test option allows individual control of all test parameters required for ESD testing; this allows testing at different levels, modes, and repetition rates. The test parameters are:

| ESD Test Parameter      | Range/Units                                     |
|-------------------------|---|
| <u>Voltage</u>          | [-8800...-250, +250...+8800] V; resolution: 5 V |
| <u>Tip</u>              | Air or Contact                                  |
| <u>Mode</u>             | Normal or Tripod                                |
| <u>Repetition Rate</u>  | [1pps, 20pps]                                   |
| <u>Number of Pulses</u> | [1 . . . 999]                                   |

## Preprogrammed IEC Standard ESD Test Sequences

Two preprogrammed test sequences are stored in the **EMCPro PLUS** for rapid testing to the IEC standards of IEC 1000-4-2.

There are two tests mandated by the specifications - a 4 kV contact discharge and an 8 kV air discharge. Repetition is set for 1 pps and polarity is set by the user to the most sensitive polarity. The user can select mode -- normal or tripod -- and the number of pulses.

The table below shows these two tests:

| Tests   | Voltage, kV | Number of Discharges        | Repetition, pps |
|---------|-------------|-----------------------------|-----------------|
| Contact | 4           | 10 positive,<br>10 negative | 1               |
| Air     | 8           | 10 positive,<br>10 negative | 1               |

---

## ESD Waveform Verification

IEC 1000-4-2 requires that the ESD output be verified periodically. Verification requires an ESD target (Thermo **CTC-3**), a target plane (Thermo **TP-1**), and an oscilloscope of 1GHz minimum bandwidth. The ESD probe with contact-mode tip is placed on a tripod, the **EMCPro PLUS** set to TRIPOD mode, 1pps.

The rise time, peak amplitude and amplitude at 30 ns and 60 ns should be monitored and recorded and checked against the figure and table at the start of this section.

---

Performing ESD calibration is not trivial. The high-speed oscilloscope is expensive; the extremely fast risetime and high-bandwidth required by specification can require that a dedicated test site be built, with Faraday-shields for the oscilloscope, and EMI damping materials on floors and walls to reduce reflections.

Thermo Electron Corporation offers a calibration service for all equipment, including the ESD probe. Contact factory for details.

---

---

# IEC 1000-4-4 -- EFT Testing

---

For safety reasons, the precautions taken during EFT testing should be the same as for Surge testing -- read and follow the guidelines of the **Safety Concerns During Surge Testing** section.

It is important that the Equipment Under Test be properly connected -- read and follow the guidelines of the **Test Area Considerations and Site Preparation** section and of the **Special Considerations for EFT Testing** section, as well as the **Testing Requirements per IEC 1000-4-4** section which follows.

---

## What is Electrical Fast Transients (Burst) Testing?

The electrical fast transient test consists of a burst of fast pulses, coupled into power supply, control and signal ports of electrical and electronic equipment. The significant characteristics of the test are very high amplitude, the short rise time, the high repetition rate, and the low energy of the transients.

The test is intended to demonstrate the immunity of electrical and electronic equipment when subjected to types of transient disturbances such as those originating from switching transients (interruption of unsuppressed inductive loads, relay contact bounce, etc.).

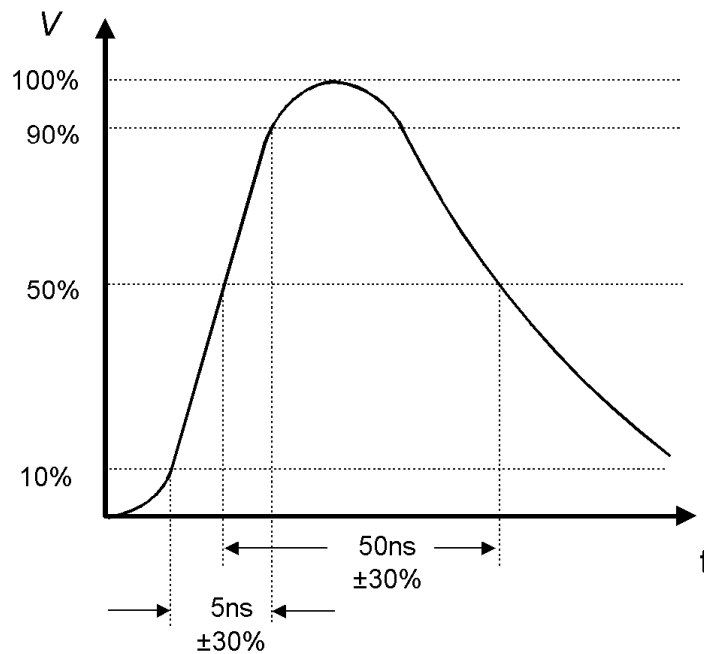

EFT Waveform

---

## General Guidelines for EFT Testing

The EFT test voltage is referenced to the chassis of the **EMCPro PLUS**. The EFT waveform is coupled into the EUT via the AC Mains and the mains coupler built into the **EMCPro PLUS**, or via signal lines (or both). An optional Capacitive Cable Clamp is available for coupling to signal lines or to power lines where the **EMCPro PLUS** internal coupler cannot be used.

When applied to the EUT Mains, the EFT voltage is applied between ground -- the Ground Reference Plane (GRP) -- and each of the power supply terminals and between the GRP and the protective earth of the EUT.

Power-line -- Mains -- testing is performed by plugging the EUT into the **EMCPro PLUS** EUT outlet, establishing the EUT in a normal operating mode, and applying the EFT waveform to, first the line (L1), then neutral (L2), then PE.

Data-line testing starts with the EUT and auxiliary equipment plugged into the **EMCPro PLUS** EUT outlet -- to prevent EFT waveforms from contaminating the AC Mains -- and couples the EFT waveform from the CLAMP outlet to a Capacitive Cable Clamp where the waveform is coupled into the signal lines. The Capacitive Cable Clamp should be adjusted to fit snugly about the cables to be tested.

The **EMCPro PLUS** contains orientation-sensitive components, and will only perform EFT testing when operated in a horizontal position; for accurate, repeatable results the **EMCPro PLUS** should be level, and should be used in a location free from vibration.

## EFT Testing Requirements per IEC 1000-4-4

Testing to IEC 1000-4-4 has the following requirements:

- Testing takes place in climatic conditions as follows:
  - Ambient temperature: 15 °C to 35 °C
  - Relative Humidity: 25 % to 75 %
  - Atmospheric Pressure: 86 kPa (860 mbar) to 106 kPa (1060 mbar)
- A ground reference plane (GRP) is required, and is bonded to building protective earth (PE) ground.
- The EUT shall be positioned at least 0.5 m from walls and any metallic structures.
- The EUT shall be connected to the grounding system, representative of good installation practice; no additional earthing connections are allowed.
- Positioning of power and signal cables shall be representative of good installation practice, EXCEPT:
  - The length of signal and power cables shall be 1 meter or less.
  - If the length of signal or power cable exceeds 1 meter, the excess length shall be gathered into a flat coil with a diameter of 0.4 m and situated at a height of 0.1 m above the GRP.

IEC 1000-4-4 requires the use of a ground plane which must be bonded to building Protective Earth (PE) ground. The minimum size of the ground plane is 1 m<sup>2</sup>, the exact size depending on

---

the dimensions of the EUT and **EMCPro PLUS**; the ground plane shall extend beyond the EUT and **EMCPro PLUS** by at least 0.1 m on all sides. The ground plane shall be sheet copper or aluminum of 0.25 mm minimum thickness, or 0.65 mm minimum thickness if another metal is used.

The cabinet of the **EMCPro PLUS** must be directly tied to the ground reference plane. Provision for a mounting bracket is made on the rear of the **EMCPro PLUS** and the bracket and screws are provided.

Grounding Bracket

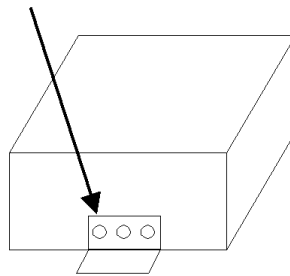

Rear View

Location of Grounding Bracket

For floor mounted equipment, the EUT shall be placed on the GRP and shall be insulated from the GRP by an insulating support 0.1 meter  $\pm$  0.01 meter thick.

For table-top equipment, the EUT should be placed on a table of height 0.8 meter  $\pm$  0.08 meter above the GRP.

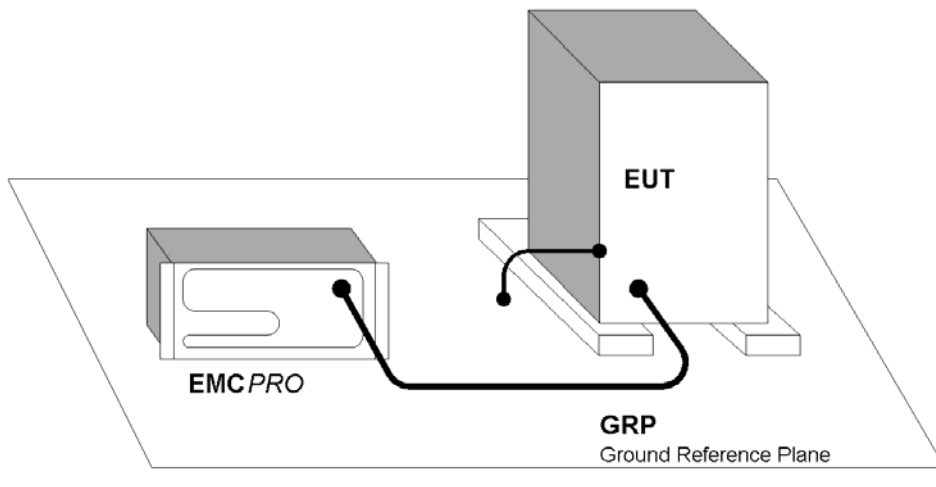

EFT Connection to Equipment Under Test for Floor-standing EUT



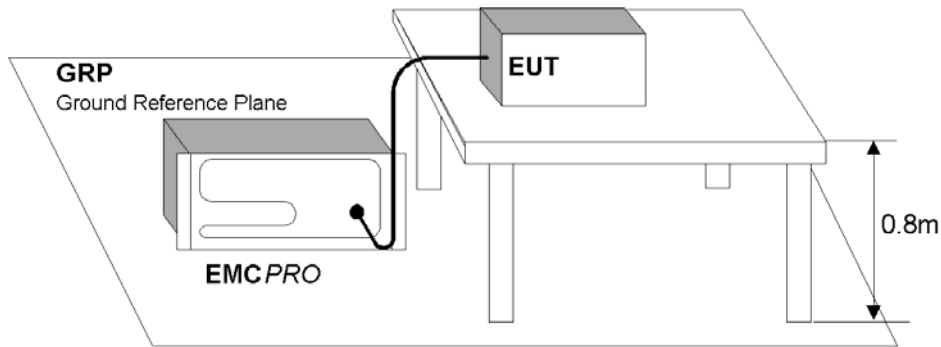

EFT Connection to Equipment Under Test for Table-top EUT

Data and signal cables are tested using the EFT Capacitive Coupling Clamp (CM-CCL). When performing these tests, the EUT and any auxiliary equipment should be powered from the **EMCPro PLUS** EUT output, to provide isolation between the test setup and building power mains. The minimum spacing required between the clamp and the equipment in the test area is shown in the figure below (Note: if the Auxiliary equipment is not considered part of the EUT, the separation distance is 5 meters as shown. If the Auxiliary equipment is considered part of the EUT, the separation drops to 1 meter).

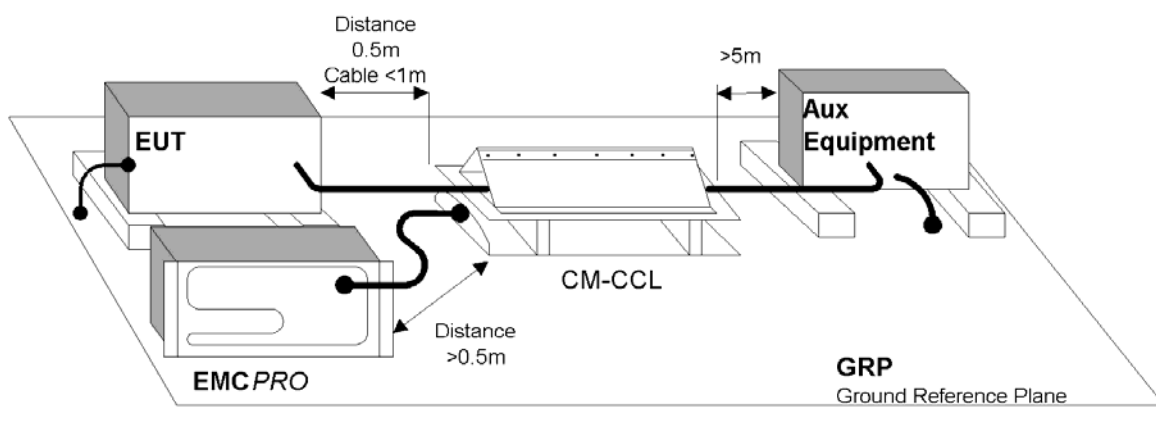

Use of the Capacitive Cable Coupler for EFT Testing

The voltage test levels to be applied vary with the test class, and are listed below:

| Test Level | Peak Voltage      | Frequency, kHz | Peak Voltage                            | Frequency, kHz |
|------------|-------------------|----------------|---|----------------|
|            | On power port, PE |                | On I/O, signal, data, and control ports |                |
| Class 1    | 500V              | 5 or 100       | 0.25kV                                  | 5kHz           |
| Class 2    | 1.0kV             | 5 or 100       | 0.5kV                                   | 5kHz           |
| Class 3    | 2.0kV             | 5 or 100       | 1.0kV                                   | 5kHz           |
| Class 4    | 4.0kV             | 5 or 100       | 2.0kV                                   | 5kHz           |

The level used in testing depends on the European Norm (EN) chosen to test against. As example, EN50082-1 (for Residential, commercial, and light industry) specifies a test level of 1000 volts. The EFT voltage is applied for one minute, for each test.

See also the section below on differences between the **EMCPro** and the **EMCPro PLUS**.

## User Defined EFT Test

The user-defined test option allows individual control of all test parameters required in EFT testing; this allows testing at different levels, modes, and repetition rates.

On being triggered by pressing the “start” key, a user defined test produces a series of output events with the parameters defined below:

| Parameter       | Range   | Resolution | Accuracy |
|-----------------|---|------------|----------|
| Voltage         | -250V ... -4400V, 250V ... 4400V  | 1V         | +/- 10%  |
| Burst Frequency | 2.5 ... 100kHz in 0.5kHz steps  | 0.5kHz     | +/- 20%  |
| Output Coupling | Clamp, Mains [Mains modes, L1, L2, PE, L1&L2, L2&PE, L1&PE, or L1&L2&PE<br>All outputs with respect to Groundplane] |            |          |
| Test Duration   | 1...999 seconds   | 1 second   |          |

## Preprogrammed EFT Test Sequences

Three preprogrammed test sequences are stored in the **EMCPro PLUS** for rapid testing to the IEC standards. These test sequences are designed to satisfy the requirements of EN50082-1 and EN50082-2.

| Test Sequence | Peak Voltage | Frequency | Port           | Coupling Mode<br>Mains only | Number of Bursts                              |
|---------------|--------------|-----------|----------------|-----------------------------|---|
| Class 1       | 500V         | 5kHz      | Mains or Clamp | PE to groundplane.          | 200 (1 minute) per polarity                   |
| Class 2       | 1.0kV        | 5kHz      | Mains or Clamp | L1, L2, and PE in sequence  | 200 (1 minute) per polarity and coupling mode |
| Class 3       | 2.0kV        | 5kHz      | Mains or Clamp | L1, L2, and PE in sequence  | 200 (1 minute) per polarity and coupling mode |
| Class 4       | 4.0kV        | 2.5kHz    | Mains or Clamp | L1, L2, and PE in sequence  | 200 (1 minute) per polarity and coupling mode |

All tests are run twice: once in each polarity.

---

## EFT Waveform Verification

IEC 1000-4-4 requires that the EFT output be verified periodically. For verification, the output of the generator is connected to an oscilloscope through a 50-ohm, high-voltage coaxial attenuator. The rise time, duration, and repetition rate of the impulses within one burst should be monitored and recorded. The amplitude into 50 ohms is one-half of the programmed voltage,  $\pm 10\%$ .

The bandwidth of oscilloscope and attenuator must exceed 400MHz. For digital oscilloscopes a sampling rate exceeding 1GSa/s is recommended. The attenuator must have a voltage rating of 1250V minimum.

The test setup shown below is usable for Waveform Verification. The BARTH Model 2237HFNFP attenuator<sup>4</sup> has sufficient voltage and power rating to connect directly to the **EMCPro PLUS** output. The Tektronix<sup>5</sup> attenuators drop the voltage to within the range of typical oscilloscope inputs. The circuit below provides a total attenuation of 1000:1.

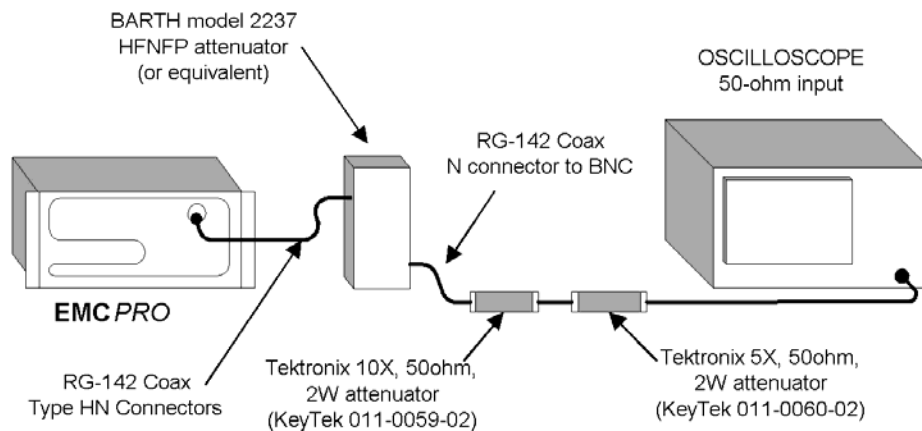

### Recommended Test Setup for Waveform Verification



#### **CAUTION**

The circuit above is for measurement of the EFT waveform at the HN-coax connector; this circuit is not rated for use across the AC Mains outlet.

**Connecting this circuit across the AC Mains with Mains voltage present will result in damage of the attenuator.**

If measuring EFT waveform at the AC Mains outlet: Check that the EUT switch is off and no AC is applied to the EUT Mains Inlet before connecting the attenuator; make the measurement and remove the attenuator immediately.

---

<sup>4</sup> Barth Electronics, Inc., 1300 Wyoming St., Boulder City, NV 89005 USA

<sup>5</sup> Tektronix, Inc., P.O. Box 1000, Wilsonville, OR 97070-1000 USA

---

# SURGE Testing

---

Surge testing is hazardous -- read and follow the guidelines of the **Safety Concerns During Surge Testing** section.

It is important that the Equipment Under Test be properly connected -- read and follow the guidelines of the **Test Area Considerations and Site Preparation** section and of the **Special Considerations for Surge Testing** section.

---

## What is Surge Testing?

Surge testing is the application of unidirectional surges to the Equipment Under Test to model those caused in the real world by overvoltages from switching and lightning transients.

Surges occur on the AC power mains as a result of switching operations in the power grid and from nearby lightning strikes, either directly to the power distribution system or to nearby ground. Radiated coupling of surges into I/O lines can also occur.

Electronic products are tested for Surge immunity to insure their continued reliable operation if subjected to realistic levels of surge voltages.

The waveform used for IEC testing of the AC Mains and I/O lines is the 1.2/50  $\mu$ s open circuit voltage (8/20  $\mu$ s short circuit current) combination wave. This waveform is separately characterized by the open circuit voltage and short circuit current.

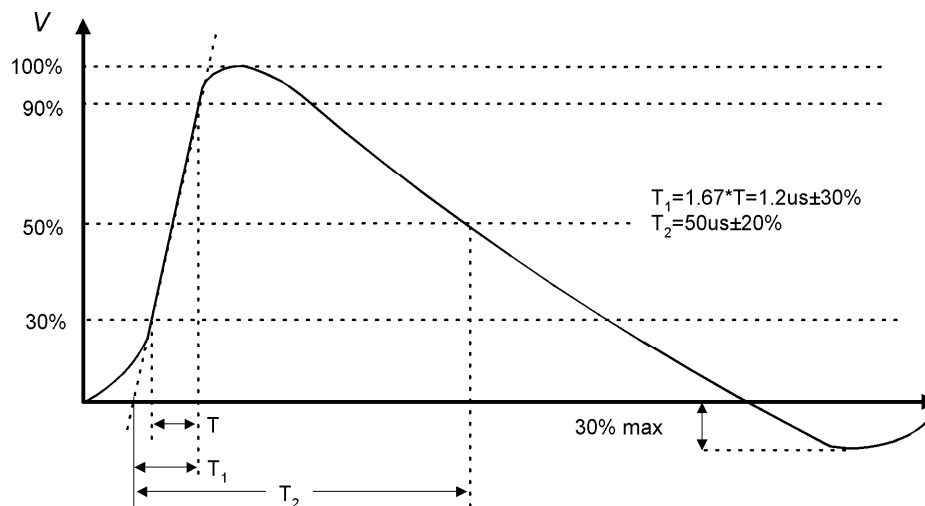

Combination Wave-Open-Circuit Surge Voltage

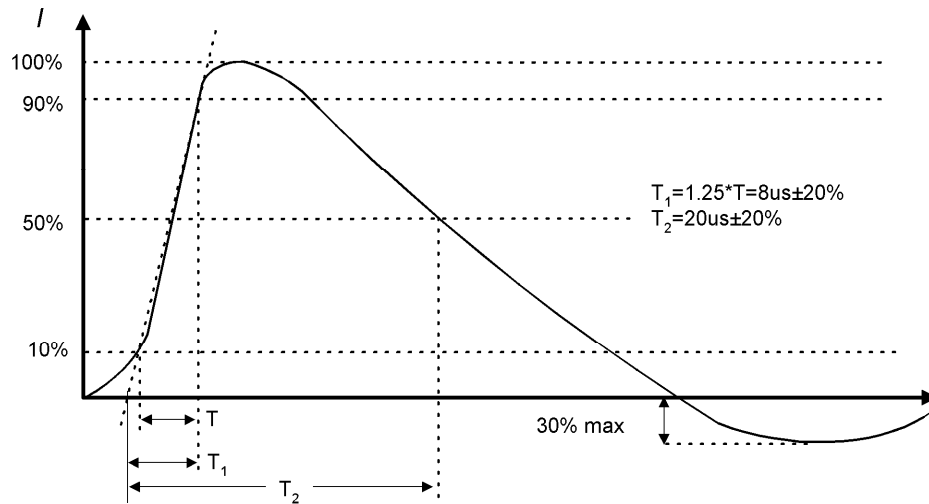

Combination Wave-Short-Circuit Surge Current

The waveform for IEC testing of communication lines (I/O lines) and telecommunication lines is the 10/700us waveform; the open circuit voltage and short circuit current for this waveform are defined in the figures below. The current waveform has a peak current of 400A at 6000V programmed voltage. The current waveform is defined with 40 ohms series impedance, requiring the addition of 25 ohms outside of **EMCPro PLUS**.

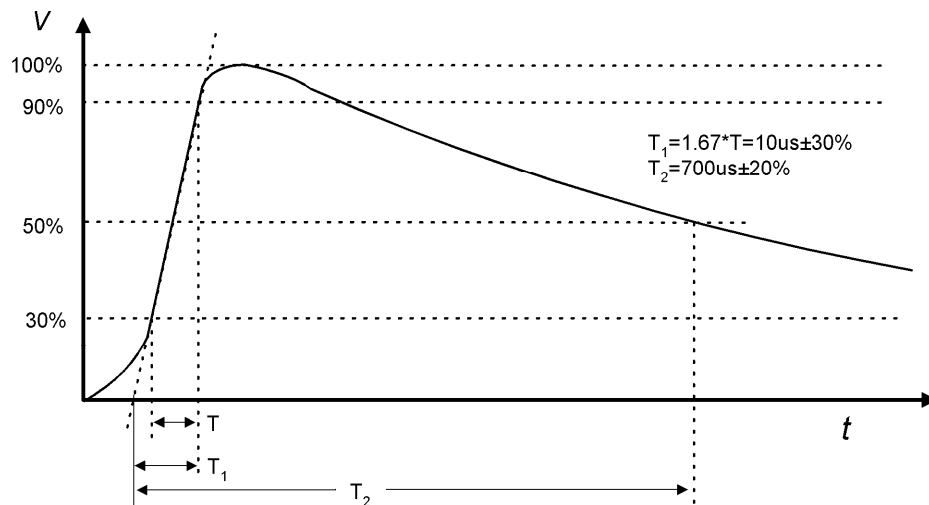

10/700us Voltage Waveform per IEC 1000-4-5 and CCITT

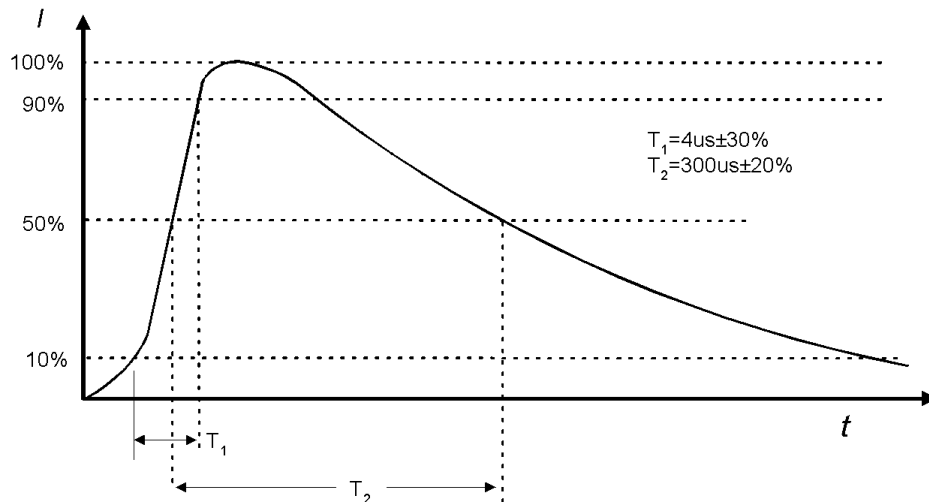

10/700us Current Waveform per IEC 1000-4-5 and CCITT

In the **EMCPro PLUS** the 10/700us Waveform is an option; this waveform is only available with the purchase of the **PRO-SURGE+TELECOM** or **PRO-TELECOM** option.

As an alternative, a 100kHz Ringwave can be substituted for the 10x700us Waveform. Available as option, **PRO-SURGE+RING** or **PRO-RING**, the Combination Wave allows testing of power mains per the IEC standards, and the 100kHz Ringwave and Combination Waveform allows testing to the requirements of IEC 1000-4-12 and ANSI / IEEE C62.41-1991. The Ringwave risetime is 0.5 vs (10-90%). The Ringwave has two waveforms available, described by their peak, short-circuit current: a 200A peak current Ringwave at 6000V and a 500A peak current Ringwave at 6000V.

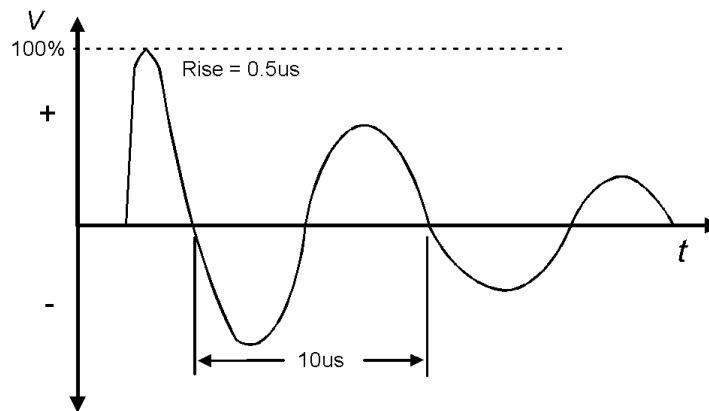

100kHz Ringwave Waveform per IEC 1000-4-12 and ANSI / IEEE C62.41-1991

## General Guidelines for Surge Testing

Surge testing is very useful to determine if breakdown of components will occur when subjected to a high-voltage impulse. Surge testing can be performed on AC or DC power Mains, communications lines, and components.

---

The **EMCPro PLUS** includes a built-in coupler, which can place combination-wave or Ringwave surges on AC or DC Mains for application to the EUT. The 10/700  $\mu$ s waveform is not available through the coupler - as a Telecommunications waveform, it is only available from the front panel. The angle of application onto the AC Mains waveform can be precisely controlled; application at 90° and 270° cause the surge to add to the peak line voltage for worst-case voltage; application at other angles can be used to find sensitive components -- such as diodes, SCRs, or solid-state switches -- which are most sensitive at the time they turn on or off.

The **EMCPro PLUS** also has front panel, safety socket connections to apply surges to the magnetic field test coil (**CM-HCOIL**) or for component testing. The **CM-I/OCD, and PRO-TELECOM** optional accessories provide convenient coupling of surges onto data and telecom lines.

When surging a DC Mains or the EUT with no mains applied, the Line Coupling Phase Angle selection must be set to 'RND' -- random -- otherwise the test would be unable to synchronize to a DC mains and would not run.

The **EMCPro PLUS** contains orientation-sensitive components, and will only perform Surge testing when operated in a horizontal position; for accurate, repeatable results, the **EMCPro PLUS** should be level, and should be used in a location free from vibration.

Probing the EUT during Surge testing should be attempted only by experienced test engineers. When connecting probes to the EUT, follow these guidelines:

- Use balanced, differential, high-voltage probes rated for the surge voltage (such as the Thermo PK1001D probe set). Most oscilloscope probes are rated for 600Vac or less and should NOT be used in Surge testing.
- Current should be measured with a non-contact, high-bandwidth current transformer (a Pearson<sup>6</sup> model 110 current transformer, or equivalent).
- **Do not connect probe grounds to the EUT!** This will create a path for Surge and fault currents, which can endanger the operator and test equipment.
- **Do not defeat protective grounding or earthing of the oscilloscope or other test instrument.**
- If connecting a voltmeter or other high-impedance test equipment to the EUT, carefully check the common-mode voltage rating of the equipment. This is the voltage rating of both probes above the instrument ground. Surge testing will typically exceed the common-mode voltage rating of most Mains-powered equipment, and can exceed the rating of battery-powered

---

<sup>6</sup> Pearson Electronics, Inc., 1860 Embarcadero Rd., Palo Alto, CA 94303 USA

---

equipment. Use of an instrument above its common-mode voltage rating may result in improper operation or damage.

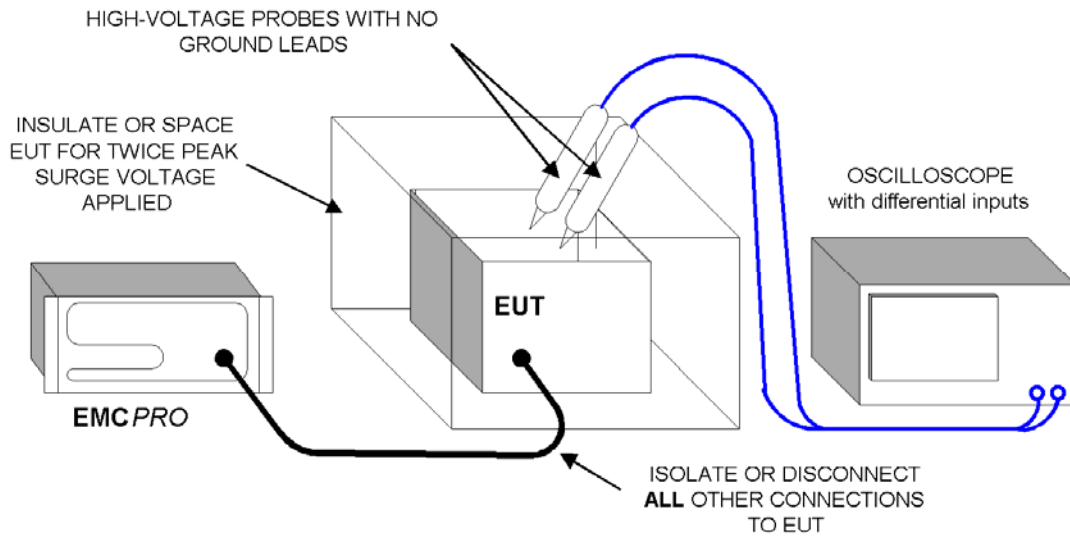

Connection of Probes to the EUT during Surge Testing



---

## Surge Testing Requirements per IEC 1000-4-5

The Basic EMC Standards for Surge define the methods of generating consistently reproducible surge voltages for test purposes. They specify generator and coupler/decoupler design and performance in sufficient detail to produce correlatable results between test sites. These are issues which are controlled by the design of the **EMCPro PLUS** and need not be considered by the operator or user.

While the Basic EMC Standard specifies how to perform Surge testing, the Generic, Product and Product Family Standards specify the test levels and pass/fail performance criteria. IEC 1000-4-5 also includes a climatic specification, as follows:

- Testing takes place in climatic conditions as follows:
  - Ambient temperature: 15 °C to 35 °C
  - Relative Humidity: 10 % to 75 %
  - Atmospheric Pressure: 86 kPa (860 mbar) to 106 kPa (1060 mbar)Note that other values may be specified in the test specification. The EUT should be operated within its intended climatic conditions.

The test level, polarity, and source impedance are set by the European Norms (EN), as a function of use and exposure class (See the Class Definition Table and Test Levels Table, below). The **EMCPro PLUS** is capable of testing to Classes 0, 1, 2, 3, 4, and 5 test levels.

The general test requirements, per IEC 1000-4-5 are as follows:

|   |  |
|---|--|
| <i><b>Output polarity</b></i>           | Both positive and negative   |
| <i><b>Output (source) impedance</b></i> | For power supply (AC or DC), line to line surges: 2 $\Omega$<br>For power supply (AC or DC), line to earth surges: 12 $\Omega$<br>For direct coupling to communication lines: 40 $\Omega$<br>(2 or 12 $\Omega$ selected from <b>EMCPro PLUS</b> , and additional, external resistance added) |
| <i><b>Number of tests</b></i>           | At least five positive and five negative tests at each test level  |
| <i><b>Repetition rate</b></i>           | Maximum: 1 surge per minute  |
| <i><b>Mains Synchronization</b></i>     | 0° or 180°, 90°, and 270°  |

### Class definitions

|         |   |
|---------|---|
| Class 0 | Well-protected electrical environment, often within a special room.   |
| Class 1 | Partly protected electrical environment.  |
| Class 2 | Electrical environment where the cables are well separated, even at short runs.   |
| Class 3 | Electrical environment where cables run in parallel.  |
| Class 4 | Electrical environment where the interconnections are running as outdoor cables along with power cables, and cables are used for both electronic and electric circuits. |
| Class 5 | Electrical environment for electronic equipment connected to telecommunication cables and overhead power lines in a non-densely populated area.                         |
| Class x | Special conditions specified in the product specification.  |

### Voltage Test Levels vs. Class, Combination wave

| Class | Test levels (kV)                         |                   |   |                   |  |                   |   |               |
|-------|--|-------------------|---|-------------------|--|-------------------|---|---------------|
|       | Power supply Coupling Mode (Combination) |                   | Unbalanced datalines, LDB Coupling mode (Combination) |                   | Balanced datalines Coupling mode (Telecom) |                   | SDB, DB <sup>1)</sup> Coupling mode (Combination) |               |
|       | Line to line                             | Line to earth     | Line to line  | Line to earth     | Line to line                               | Line to earth     | Line to line                                      | Line to earth |
| 0     | NA                                       | NA                | NA  | NA                | NA   | NA                | NA  | NA            |
| 1     | NA                                       | 0.5               | NA  | 0.5               | NA   | 0.5               | NA  | NA            |
| 2     | 0.5                                      | 1.0               | 0.5   | 1.0               | NA   | 1.0               | NA  | 0.5           |
| 3     | 1.0                                      | 2.0               | 1.0   | 2.0 <sup>3)</sup> | NA   | 2.0 <sup>3)</sup> | NA  | NA            |
| 4     | 2.0                                      | 4.0 <sup>3)</sup> | 2.0   | 4.0 <sup>3)</sup> | NA   | 2.0 <sup>3)</sup> | NA  | NA            |
| 5     | <sup>2)</sup>                            | <sup>2)</sup>     | 2.0   | 4.0 <sup>3)</sup> | NA   | 4.0 <sup>3)</sup> | NA  | NA            |
| x     |  |                   |   |                   |  |                   |   |               |

1) Limited distance, special configuration, special layout, 10 m to max. 30 m: no test is advised at interconnection cables up to 10 m, only class 2 is applicable.

2) Depends on the class of the local power supply system.

3) Normally tested with primary protection.

Explanation:

|     |   |                      |     |   |                    |
|-----|---|----------------------|-----|---|--------------------|
| DB  | = | data bus (data line) | SDB | = | short-distance bus |
| LDB | = | long-distance bus    | NA  | = | not applicable     |

## User Defined Surge Tests

The User Defined menu allows individual control of all test parameters required in surge testing; this allows testing at different levels, modes, and repetition rates.

A User defined Surge Test is controlled by a set of test parameters and results in a surge event, or number of surge events, whose parameters are defined in the tables below.

### User Defined Surge Test -- 1.2/50us Combination Wave

| Surge Test Parameter             | Range/Units   |
|----------------------------------|---|
| <u>Waveform</u>                  | Auto, 2, 12 $\Omega$ Output Impedance (source impedance)<br>For Waveform = "Auto": If the Output is MAINS and the Line Coupling is PE, then the Output Impedance is 12 $\Omega$ ; otherwise the Output Impedance is 2 $\Omega$ .                                |
| <u>Surge Voltage</u>             | [-6600..+6600] V; resolution: 1 V   |
| <u>Output</u>                    | Direct (safety sockets), MAINS (EUT output receptacle)  |
| <u>Line Coupling</u>             | For <u>Output</u> = Direct : [N/A]<br>For <u>Output</u> = MAINS: ( <sup>Surge HIGH</sup> / <sub>Surge LOW</sub> ) = [ <sup>L1</sup> / <sub>L2</sub> , <sup>L1</sup> / <sub>PE</sub> , <sup>L2</sup> / <sub>PE</sub> , ( <sup>L1 and L2</sup> )/ <sub>PE</sub> ] |
| <u>Line Coupling Phase Angle</u> | For <u>Output</u> = Direct : [not applicable]<br>For <u>Output</u> = MAINS: [Random, 0..360 °]; resolution: 1°<br>Random is required when surging a DC Mains, or when surging the EUT outlet with no EUT power applied.   |
| <u>Interval Between Tests</u>    | (15..999) s; resolution: 1 s<br>If a number is entered which is less than the minimum time required to charge the circuit to the required <u>Surge Voltage</u> , the time will be replaced with the minimum time.   |
| <u>Number of Tests</u>           | [1..999]<br>When the operator presses the START key, the system will execute the specified number of Charge and Surge cycles; the surge will occur automatically every <u>Interval Between Tests</u> , preceded by an audible warning.                          |

## User Defined Surge Test -- 10/700us Wave

| Surge Test Parameter          | Range/Units  |
|-------------------------------|--|
| <u>Surge Voltage</u>          | [-6600..+6600] V; resolution: 1 V  |
| <u>Interval Between Tests</u> | (15..999) s; resolution: 1 s<br>If a number is entered which is less than the minimum time required to charge the circuit to the required <u>Surge Voltage</u> , the time will be replaced with the minimum time.                      |
| <u>Number of Tests</u>        | [1..999]<br>When the operator presses the START key, the system will execute the specified number of Charge and Surge cycles; the surge will occur automatically every <u>Interval Between Tests</u> , preceded by an audible warning. |

## User Defined Surge Test – 100kHz Ringwave

| Surge Test Parameter             | Range/Units  |
|----------------------------------|--|
| <u>Waveform</u>                  | 200A, 500A   |
| <u>Surge Voltage</u>             | [-6600..-250, +250..+6600] V; resolution: 1 V  |
| <u>Output</u>                    | Direct (safety sockets), MAINS (EUT output receptacle)   |
| <u>Line Coupling</u>             | For <u>Output</u> = Direct : [N/A]<br>For <u>Output</u> = MAINS: ( $\text{Surge HIGH} / \text{Surge LOW}$ ) = [ $L^1/L^2, L^1/PE, L^2/PE, (L^1 \text{ and } L^2)/PE$ ]   |
| <u>Line Coupling Phase Angle</u> | For <u>Output</u> = Direct : [not applicable]<br>For <u>Output</u> = MAINS: [Random, 0..360 °]; resolution: 1°<br>Random is required when surging a DC Mains, or when surging the EUT outlet with no EUT power applied.                |
| <u>Interval Between Tests</u>    | (15..999) s; resolution: 1 s<br>If a number is entered which is less than the minimum time required to charge the circuit to the required <u>Surge Voltage</u> , the time will be replaced with the minimum time.                      |
| <u>Number of Tests</u>           | [1..999]<br>When the operator presses the START key, the system will execute the specified number of Charge and Surge cycles; the surge will occur automatically every <u>Interval Between Tests</u> , preceded by an audible warning. |

---

## Preprogrammed IEC Standard Surge Test Sequences

Each of the preprogrammed tests is a set of sequentially executed tests where most parameter values are predefined. Preprogrammed tests are based on the IEC Installation Class definitions.

“Fast” test sequences perform tests to one and only one Class level, while “Full” test sequences follow the directions of IEC 1000-4-5, testing to a Class test level and all Classes below that level. A “Full” test sequence is required to certify equipment. A “Fast” test sequence allows quickly tracking down problems; e.g. if a unit always passes Class 1 only to fail Class 2, the Fast test can test only the Class 2 level.

After selecting a preprogrammed test you have the options of selecting Line Coupling, and Interval between tests.

To meet the specifications of IEC 1000-4-5 the Interval between tests should be 60 seconds (the default) or greater. Use a larger interval, if needed, to verify operation of the EUT between pulses. While you can use a shorter interval to speed pre-qualification testing, note that the surge event can cause stress to the EUT; applying surges at too fast a rate may be overly stressful and could result in damage to the EUT. The time to complete column in the following table assumes the default Interval between tests is used.

When Line Coupling is set to MAINS, the **EMCPro PLUS** cycles through each line coupling mode: L1-to-L2, L1-to-PE , and L2-to-PE.

When surging a DC Mains or the EUT with no mains applied, the Line Coupling Phase Angle selection must be set to ‘RND’ --random -- otherwise the test will be unable to synchronize to a the mains power and would not run.

### Preprogrammed Test Sequences -- 10/700us Wave

| Test         | Surge Voltage |
|--------------|---------------|
| Level 1 Fast | 500           |
| Level 2 Fast | 1000          |
| Level 3 Fast | 2000          |
| Level 4 Fast | 4000          |

## Preprogrammed Test Sequences -- 1.2/50us Combination Wave

| Test         | Surge Voltage** |                     | Time to Complete (hrs:min) |                |
|--------------|-----------------|---------------------|----------------------------|----------------|
|              | L1-to-L2        | L1-to-PE & L2-to-PE | Direct Coupling            | Mains Coupling |
| Class 2 Fast | 500             | 1000                | 00:10                      | 01:30          |
| Class 3 Fast | 1000            | 2000                | 00:10                      | 01:30          |
| Class 4 Fast | 2000            | 4000                | 00:10                      | 01:30          |
| Class 1 Full | NT              | 500                 | 00:10                      | 01:30          |
| Class 2 Full |                 |                     |                            |                |
| Step 1       | NT              | 500                 | 00:30                      | 04:30          |
| Step 2       | 500             | 1000                |                            |                |
| Class 3 Full |                 |                     |                            |                |
| Step 1       | NT              | 500                 | 00:30                      | 04:30          |
| Step 2       | 500             | 1000                |                            |                |
| Step 3       | 1000            | 2000                |                            |                |
| Class 4 Full |                 |                     |                            |                |
| Step 1       | 500             | 1000                | 00:30                      | 04:30          |
| Step 2       | 1000            | 2000                |                            |                |
| Step 3       | 2000            | 4000                |                            |                |

\* not required for Class 1 test (see Class 1 Full test), but included for convenience to aid in preliminary execution of Class 2 and Class 3 tests

\*\* for Line Coupling = "N/A" (no line coupling), the Surge Voltage will be the same as for line to earth coupling ( $L^1/PE$  and  $L^2/PE$ )

Explanation: NT = no test

## Preprogrammed Test Sequences – Ringwave

Ringwave tests perform 5 tests at each: of 2 polarities; of 4 coupling modes (L1-PE, L2-PE, L1, L2-PE, L1-L2), at line synchs of 0°, 90°, and 270°. IEC test levels are the first figure for tests to PE, and the second for L1-L2

| Test          | Voltage   |
|---------------|-----------|
| 2kV 200A ANSI | 2000      |
| 4kV 200A ANSI | 4000      |
| 6kV 200A ANSI | 6000      |
| 2kV 500A ANSI | 2000      |
| 4kV 500A ANSI | 4000      |
| 6kV 500A ANSI | 6000      |
| Lev1 200A IEC | 500/250   |
| Lev2 200A IEC | 1000/500  |
| Lev3 200A IEC | 2000/1000 |
| Lev4 200A IEC | 4000/2000 |
| Lev1 500A IEC | 500/250   |
| Lev2 500A IEC | 1000/500  |
| Lev3 500A IEC | 2000/1000 |
| Lev4 500A IEC | 4000/2000 |

---

## Surge Waveform Verification

IEC 1000-4-5 requires that the simulator output be verified periodically. High voltage differential surge probes are required for verifying the open-circuit voltage, and a suitable current transformer is required for verification of the short-circuit current. A digital or storage oscilloscope with 100MHz bandwidth is sufficient for measuring the surge voltage and current waveforms and peaks.

The probes are connected across the lines to be verified (e.g. L1 and L2), the generator is programmed to apply a pulse to these lines, and the signal is captured by the oscilloscope. The peak value, rise, and duration is measured and calculated and compared to the waveforms at the beginning of this section. The tolerance for peak voltage and current is  $\pm 10\%$ .

When measuring current at the EUT outlet, the EUT outlet must be switched off and the EUT Mains power cord should be removed from the inlet for safety. When measuring voltage across the EUT output, the AC Mains should be switched off and the line synchronization set to RANDOM; this simplifies measurements, as the Surge Voltage waveform will not be superimposed on the Mains waveform.

---

## IEC 1000-4-8

# POWER-FREQUENCY MAGNETIC FIELD Testing

### What is Power Frequency Magnetic Field (PFMF) Testing?

Electronic products are often subjected to magnetic fields at AC mains frequencies. These fields are frequently produced in the vicinity of power transformers and can cause problems with CRT's, Hall effect sensors, and other electronic products having a sensitivity to magnetic fields.

Electronic Products are tested for immunity to power frequency magnetic fields to insure their continued reliable operation when placed in service.

### General Guidelines for PFMF Testing

The test magnetic field is applied by the immersion method to the EUT; in this method the EUT is placed in the center of an induction coil.

- The coil is connected to the **HCOIL** - 1.2/50us – Ring Output terminals on the **EMCPro PLUS** – top right on the front panel

The induction coil is characterized by a test volume, and an Induction Coil Factor; the coil factor is the ratio between the magnetic field strength generated by an induction coil and the current value required to obtain that field strength. For a standard coil, the coil factor is determined by the manufacturer of the coil, and can be verified by laboratory measurements before carrying out the tests.

The size and shape of the induction coil may vary, but one standard coil is the one-meter square coil available from Thermo as **CM-HCOIL**. This coil is capable of providing a constant field-strength over a volume of 0.6 by 0.6 by 0.5 meter; for EUT larger than this, a larger coil will be required. The Coil Factor for this coil is 0.87.

Since the Equipment Under Test may show sensitivity to the direction of magnetic field, the coil or EUT is typically rotated to apply the field in three orthogonal directions.

The unit of magnetic field measurement is A/m. In free-space, 1 A/m is equivalent to 1.26 micro-Teslas or 0.0126 Gauss.

The **EMCPro PLUS** operates as a current-controlled device -- it generates a sinusoidal output current. The maximum Magnetic Field Strength available in a test is dependent upon the Induction Coil Factor of the Induction Coil, as the Magnetic Field Strength is the product of the Surge Current and the Induction Coil Factor.

The **EMCPro PLUS** can source 5 amperes; this is sufficient to drive a coil with coil-factor of 0.8. to 4 A/m. With lesser coil factors, the current will increase, and this may cause distortion of the sinusoidal current. When the programmed magnetic field strength, divided by the coil factor, exceeds 5 amperes, the current should be checked for indications of distortion.



---

The **EMCPro PLUS** is calibrated with the Thermo supplied coil and cable - use of other coils or cables may not be calibrated and may require measurements of the current.

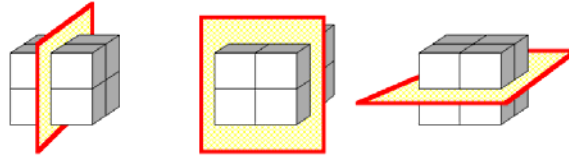

Example of the three Orthogonal Axes for Magnetic Field Testing

## **PFMF Testing Requirements per IEC 1000-4-8**

Testing to IEC 1000-4-8 has the following requirements:

- Testing takes place in climatic conditions as follows:
  - Ambient temperature: 15 °C to 35 °C
  - Relative Humidity: 25 % to 75 %
  - Atmospheric Pressure: 86 kPa (860 mbar) to 106 kPa (1060 mbar)
- A ground reference plane (GRP) is required, and is tied to building Protective Earth (PE) ground.
- The EUT shall be connected to the grounding system, representative of good installation practice.
- Positioning of power and signal cables shall be representative of good installation practice.
- A back-filter, to prevent possible interference with other equipment, is optional in IEC 1000-4-8, although required in the Pulsed Magnetic Field testing. The **EMCPro PLUS** EUT output may be used as a mains back-filter if desired.

IEC 1000-4-8 requires the use of a ground plane which must be bonded to building Protective Earth (PE) ground. The minimum size of the ground plane is 1 m<sup>2</sup>, the exact size depending on the dimensions of the EUT; the ground plane shall extend beyond the EUT by at least 0.5 m on all sides. The ground plane shall be sheet copper or aluminum of 0.25 mm minimum thickness, or 0.65 mm minimum thickness if another metal is used.

The EUT is placed on the ground reference plane, on an insulating support 0.1 meter thick. The EUT is operated normally and the magnetic field is applied. The coil is rotated twice and the test is repeated.

IEC 1000-4-8 requires that one terminal of the test generator be attached to the ground reference plane; the **EMCPro PLUS** does this internally. You should not make an external connection between coil and ground reference plane.

---

## User Defined Power Frequency Magnetic Field Test

The User Defined menu allows individual control of all test parameters required in Power Frequency Magnetic Field Immunity Testing; this allows testing at different levels, frequencies, and durations.

A User-defined test is controlled by the parameters in the table below:

| Test Parameter        | Range/Units                     |
|-----------------------|---------------------------------|
| <u>Coil Factor</u>    | 0.65...1                        |
| <u>Field Strength</u> | 0...4 A/m, in steps of 0.25 A/m |
| <u>Line Frequency</u> | 50Hz, 60Hz                      |
| <u>Duration</u>       | 1...9999 seconds                |

## Preprogrammed IEC Standard PFMF Immunity Test Sequences

There are no preprogrammed tests for Power Frequency Magnetic Field Immunity Testing.

### PFMF Waveform Verification

IEC 1000-4-8 requires that the simulator output be verified periodically. This is to ensure that the EUT is being tested at the proper test level. Waveform Verification takes place with the same setup as for EUT testing, but with the EUT removed.

Verification requires a magnetic-field strength meter. Thermo offers a magnetic-field strength meter, **CM-HMON**, for use in Verification.

The **EMCPro PLUS** is set for the desired field strength. The magnetic-field strength meter is placed in the center of the coil and oriented to achieve a maximum reading. The reading of the field meter is compared to the desired field-strength, and the coil factor adjusted accordingly: lower if the measured field strength is too low, higher if the measured field strength is too high. The measurement and adjustment may be repeated until the measured field strength is within acceptable tolerances of the desired field strength.

---

## IEC 1000-4-9

# PULSED MAGNETIC FIELD Testing

### What is PULSED MAGNETIC FIELD (PMF) Testing?

Pulse Magnetic fields are produced as a result of a large current impulse through a conductor. An example is lightning current flowing through a grounding conductor at a power sub-station. Pulse magnetic fields can also occur in heavy industrial areas where very large currents are switched in a manufacturing process.

- The coil is connected to the **HCOIL** - 1.2/50us – Ring Output terminals on the **EMCPro PLUS** – top right on the front panel

Electronic products are tested for immunity to pulse magnetic fields to insure their continued reliable operation when placed in service in a very harsh environment.

### General Guidelines for PMF Testing

The test magnetic field is applied by the immersion method to the EUT; in this method the EUT is placed in the center of an induction coil.

A test volume and an Induction Coil Factor characterize the induction coil; the coil factor is the ratio between the magnetic field strength generated by an induction coil and the current value required to obtain that field strength. For standard dimension coil, the coil factor is determined by the manufacturer of the coil, and can be verified by laboratory measurements before carrying out the tests.

The **EMCPro PLUS** operates as a current-controlled device -- it outputs a current pulse. The maximum Magnetic Field Strength available in a test is dependent upon the Induction Coil Factor of the Induction Coil, as the Magnetic Field Strength is the product of the Surge Current and the Induction Coil Factor.

The size and shape of the induction coil may vary, but one standard coil is the one-meter square coil available from Thermo as **CM-HCOIL**. This coil is capable of providing a constant field-strength over a volume of 0.6 by 0.6 by 0.5 meter; for EUT larger than this, a larger coil will be required. The Coil Factor for this coil is 0.87.

Since the Equipment Under Test may show sensitivity to the direction of magnetic field, the coil or EUT is typically rotated to apply the field in three orthogonal directions.

The unit of magnetic field measurement is A/m. In free-space, 1 A/m is equivalent to 1.26 micro-Teslas or 0.0126 Gauss.

The **EMCPro PLUS** contains orientation-sensitive components, and will only perform Surge testing when operated in a horizontal position; for accurate, repeatable results the **EMCPro PLUS** should be level, and should be used in a location free from vibration.

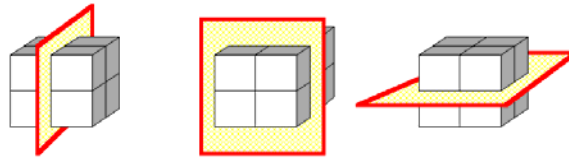

Example of the three Orthogonal Axes for Magnetic Field Testing

## PMF Testing Requirements per IEC 1000-4-9

Testing to IEC 1000-4-9 has the following requirements:

- Testing takes place in climatic conditions as follows:
  - Ambient temperature: 15 °C to 35 °C
  - Relative Humidity: 25 % to 75 %
  - Atmospheric Pressure: 86 kPa (860 mbar) to 106 kPa (1060 mbar)
- A ground reference plane (GRP) is required, and is bonded to the building Protective Earth (PE) ground.
- The EUT shall be connected to the grounding system, representative of good installation practice.
- The coil and EUT shall be positioned at least 1 meter from walls and metallic objects.
- A back-filter is required to prevent possible interference with other equipment. The **EMCPro PLUS** EUT output may be used as a mains back-filter, or a Line-impedance-stabilization-network (LISN) may be substituted. The user may have to provide additional backfilters for signal and communication lines (if any).
- Positioning of power and signal cables shall be representative of good installation practice, with the following notes:
  - Communication lines shall be maintained at a height of 0.1 meter above the GRP.
  - Backfilters on communication lines -- if used -- shall be at least one meter from the EUT.

IEC 1000-4-9 requires the use of a ground plane which must be bonded to building Protective Earth (PE) ground. The minimum size of the ground plane is 1 m<sup>2</sup>, the exact size depending on the dimensions of the EUT; the ground plane shall extend beyond the EUT by at least 0.5 m on all sides. The ground plane shall be sheet copper or aluminum of 0.25 mm minimum thickness, or 0.65 mm minimum thickness if another metal is used.

The EUT is placed on the ground reference plane, on an insulating support 0.1 meter thick. The EUT cabinet is connected to the ground plane via the EUT earth terminal (if any). The EUT is operated in a normal fashion and pulses are applied. The coil is rotated twice and the test is repeated.

IEC 1000-4-9 requires that one terminal of the test generator be attached to the ground reference plane; the **EMCPro PLUS** does this internally. You should not make an external connection between coil and ground reference plane.

---

## PMF User Defined Pulsed Magnetic Field Immunity Test

The User Defined menu allows individual control of all test parameters required in Pulsed Magnetic Field Immunity Testing; this allows testing at different levels, number of pulses, and time between tests.

A User-defined test is controlled by a the parameters in the table below:

| PMF Test Parameter             | Range/Units   |
|--------------------------------|---|
| <u>Coil Factor</u>             | [0.5..1.0]; resolution: 0.01  |
| <u>Magnetic Field Strength</u> | [-1100..-50,..+1100]<br>The <u>Magnetic Field Strength</u> is dependent upon the <u>Coil Factor</u> selected, as <u>Magnetic Field Strength</u> is the product of the <u>Surge Current</u> and the <u>Coil Factor</u> . The above range assumes a coil factor of 0.87; the actual <u>Magnetic Field Strength</u> will be less for lower coil factors.   |
| <u>Time Between Tests</u>      | [15..999 s]; resolution: 1 s<br>The lower limit is dependent on <u>Magnetic Field Strength</u> ; its value will be higher at higher <u>Magnetic Field Strength</u> , reaching a maximum of 30 s at 800 A/m. If a number is entered which is less than the minimum time required to charge the circuit to the required <u>Surge Voltage</u> , the time will be replaced with the minimum time. |
| <u>Number of Tests</u>         | [1..999]<br>When the operator presses the START key, the system will execute the specified number of Charge and Surge cycles; the surge will occur automatically every <u>Interval Between Tests</u> , preceded by an audible warning.  |

## Preprogrammed IEC Standard Pulsed Magnetic Field Immunity Test Sequences

Each of the preprogrammed tests is a set of sequentially executed tests where most parameter values are predefined. Preprogrammed tests are based on the IEC Installation Class definitions.

There are two pre-stored IEC Standard test sequences, which test to different magnetic field strengths. The only adjustment the user can make is to the time between tests.

**Class 3 Test:** This test sets the magnetic field strength to 100 A/m and programs 5 pulses.

**Class 4 Test:** This test sets the magnetic field strength to 300 A/m and programs 5 pulses.

**Class 5 Test:** This test sets the magnetic field strength to 1000A/m and programs 5 pulses.

---

## PMF Waveform Verification

IEC 1000-4-9 requires that the simulator output be verified periodically, to ensure that the EUT is being tested at the proper test level. Waveform Verification takes place with the same setup as for EUT testing, but with the EUT removed.

Calibration requires a digital or storage oscilloscope with 100MHz bandwidth, a magnetic-field strength meter, and an inductive current probe and true-rms voltmeter capable of measuring 10 amperes peak with bandwidth exceeding 100Hz (the oscilloscope may be substituted for the voltmeter). Thermo offers a magnetic-field strength meter , **CM-HMON**, for use in Verification. A Pearson<sup>7</sup> model 110 current transformer (or equivalent) may be used as the current probe.

The current probe is placed over one of the coil leads. The **EMCPro PLUS** is set for Power Frequency Magnetic Field testing, and programmed for a field strength of three A/m. The magnetic-field strength meter is placed in the center of the coil and oriented to achieve a maximum. This reading is recorded. The rms-reading of the current is recorded. The ratio of magnetic field to current is calculated and recorded.

The **EMCPro PLUS** is set for Pulsed Magnetic Field testing, and programmed for the proper field strength specified by the test level. A pulse is programmed and the peak current recorded via the oscilloscope. The ratio of magnetic-field to current -- calculated in the prior step -- is multiplied by the peak current -- measured in this step -- to obtain the actual magnetic field applied during test. This result is compared to the test level, and the coil factor adjusted accordingly: lower if the measured field strength is too low, higher if the measured field strength is too high. The measurement and adjustment may be repeated until the measured field strength is within acceptable tolerances of the desired field strength.

Alternatively, a peak reading magnetic field meter of bandwidth greater than 10MHz may be used. In this case the magnetic field may be measured directly (the current need not be measured).

---

The current waveform obtained in Pulsed Magnetic Field Testing is identical to that obtained in Surge testing. IEC 1000-4-9 refers to the wave as a 6.4/16uS wave; this is the result of a difference in definition of risetimes and duration. Per IEC 1000-4-9, the risetime is simply the time from 10% to 90% with no multiplier. The duration is simply the time from 50% of rise to 50% of fall.

---

---

<sup>7</sup> Pearson Electronics, Inc., 1860 Embarcadero Rd., Palo Alto, CA 94303 USA

---

# IEC 1000-4-11

## POWER QUALITY FAILURE Testing

### What is Power Quality Failure (PQF) Testing?

Dips and interrupts can occur on the AC power mains as a result of a fault in the distribution system such as an open circuit breaker or a sudden large load being turned on in the immediate vicinity. A power distribution system fault can cause a switch in the distribution grid to open and close a number of times, resulting in multiple interrupts to electrical and electronic equipment.

Electronic products are tested for immunity to dips and interrupts to insure their continued reliable operation if subjected to dips and/or interrupts on the AC power mains.

### General Guidelines for PQF Testing

The EUT is connected to the EUT outlet and powered. The EUT is allowed time to stabilize, and then a dip or interrupt is applied to the EUT. The duration and level of the dip is set by the test requirements.

The IEC 1000-4-11 sets three levels for PQF test; 70%, 40%, and 0% of mains voltage. Thermo provides two types of zero-percent levels:

0%(OPEN) -- Represents a local (breaker or fuse) failure, with the AC mains at zero volts and in a high impedance state -- open.

0%(SHORT) -- Represents a remote (power system) failure, with the AC mains at zero volts and in a low impedance state -- short.

In addition to the standard test levels of 0%(open), 0%(short), 40%, and 70%, which are required for IEC testing and generated internally by the **EMCPro PLUS** an AUX input on the rear of the **EMCPro PLUS** allows testing to any level which the user-provides.

The **EMCPro PLUS** provides a PQF synchronization signal on the front panel; this connector will output a 5V pulse at the beginning of a PQF event (there is no pulse for Line Qualification tests).

---

## Testing Requirements per IEC 1000-4-11

Testing to IEC 1000-4-11 has the following requirements:

- Testing takes place in climatic conditions as follows:
    - Ambient temperature: 15 °C to 35 °C
    - Relative Humidity: 25 % to 75 %
    - Atmospheric Pressure: 86 kPa (860 mbar) to 106 kPa (1060 mbar)
- Or other values of climatic conditions as given in the product specifications.

IEC 1000-4-11 requires the generator be capable of supplying peak inrush currents of up to 500A for 220V to 240V mains, and up to 250A for 100V to 120V mains. The **EMCPro PLUS** is designed to meet these levels, however -- due to building wiring capabilities -- the site where the **EMCPro PLUS** is being used may not meet the requirement.

The peak inrush current should be measured at the test site, using the circuit and method described in the **Waveform Verification** section.

If the **EMCPro PLUS** test site meets the inrush current requirement (500A peak for 220V to 240V mains, or 250A for 100V to 120V mains), it is not necessary to measure the EUT peak inrush current.

If the **EMCPro PLUS** test site does not meet the inrush current requirement, the test can still be performed as long as the EUT peak inrush current is less than the peak inrush current of the **EMCPro PLUS** test site. In this case, it is necessary to measure the EUT peak inrush current. The circuit and method for measuring EUT peak inrush current is described in the **Waveform Verification** section.

## User Defined PQF Test

The User Defined menu allows individual control of all test parameters required in PQF Testing; this allows testing at different levels, phase angles, number of tests, and time between tests.

A User-defined test is controlled by the parameters in the table below:



| PQF Test Parameter         | Range/Units   |
|----------------------------|---|
| <u>Test Level</u>          | [0% (open circuit), 0% (short circuit), 40%, 70%, External]<br><u>Test Level</u> is the level of voltage during a test, as % of line voltage. The line voltage level before and after a test is the <u>Default/Standby Test Level</u> = 100%  |
| <u>Starting Angle</u>      | [0..360] ° of the line voltage waveform; resolution: 1°<br><u>Starting Phase Angle</u> is the phase angle at which the dip or interruption begins   |
| <u>Test Duration Units</u> | [cyc, sec], cyc is periods (cycles) of the Mains and sec is time in seconds   |
| <u>Test Duration</u>       | If <u>Test Duration Units</u> = “cyc”: [0.1..3000.0] ; in the periods (cycles) of the line voltage waveform<br>If <u>Test Duration Units</u> = “sec”: [0.01..60.00] s; where s is time in seconds<br><u>Test Duration</u> is the duration of the dip or interruption, in either waveform periods or seconds |
| <u>Time Between Tests</u>  | [10..999] s; resolution: 1 s  |
| <u>Number of Tests</u>     | [1..999]  |

## Preprogrammed IEC Standard PQF Test Sequences

Each is made up of a set of sequentially executed tests. The individual tests are similar to user defined PQF tests, except that all parameter values are predefined; none are changeable.

There are 11 Preprogrammed IEC Standard test sequences.

| <b>Test Sequence Name</b> | <b>Test Level</b>  | <b>Test Duration</b>  |
|---------------------------|--------------------|---|
| 0% Open / 250 cyc         | 0% (open circuit)  | 3 tests of 250 line frequency cycles each   |
| 0% Short / 250 cyc        | 0% (short circuit) | 3 tests of 250 cycles   |
| 40% / 5 cyc               | 40%                | 3 tests of 5 cycles   |
| 40%/ 5 and 50 cyc         | 40%                | 3 tests of 5 cycles each, then 3 tests of 50 cycles each  |
| 70% / 0.5 cyc             | 70%                | 3 tests of a half cycle starting at 0 degrees phase angle, then 3 tests of a half cycle starting at 180 degrees phase angle   |
| Combination / cyc         | see right          | <ul style="list-style-type: none"> <li>• Perform one IEC Standard “70%/0.5 cyc” test sequence</li> <li>• Perform one IEC Standard “40%/ 5 and 50 cyc” test sequence</li> <li>• Perform one IEC Standard “0% Short/250 cyc” test sequence</li> <li>• Perform one IEC Standard “0% Open/250 cyc” test sequence</li> </ul> |
| 0% Open / 5 s             | 0% (open circuit)  | 5.00 s  |
| 0% Short / 5 s            | 0% (short circuit) | 5.00 s  |
| 40% / 0.10 s              | 40%                | 0.10 s  |
| 70% / 0.01 s              | 70%                | 0.01 s  |
| Combination / sec         | see right          | <ul style="list-style-type: none"> <li>• Perform one IEC Standard “70%/0.01 s” test sequence</li> <li>• Perform one IEC Standard “40%/0.10 s” test sequence</li> <li>• Perform one IEC Standard “0% Short/5 s” test sequence</li> <li>• Perform one IEC Standard “0% Open/5 s” test sequence</li> </ul>                 |

---

Each sequence has the following, common characteristics:

- Default/Standby Test Level = 100%
- Starting Phase Angle = 0° (and also 180° for Test Duration < 0.02 s)
- Interval Between Tests = 10 s
- Number of Tests = “N/A”

Each of the IEC Standard test sequences, except the “Combination” tests, is performed at the Test Level and using the Test Duration defined in the table above, as follows:

- Start at the Default/Standby Test Level
- Switch to the Test Level at Starting Phase Angle = 0°, and maintain for Test Duration
- Switch to the Default/Standby Test Level, and maintain for Interval Between Tests
- Switch to the Test Level at Starting Phase Angle = 0°, and maintain for Test Duration
- Switch to the Default/Standby Test Level, and maintain for Interval Between Tests
- Switch to the Test Level at Starting Phase Angle = 0° and maintain for Test Duration
- Switch to the Default/Standby Test Level
  
- If Test Duration is less than 0.02 s, then, in addition to the above:
  - Wait for Interval Between Tests
  - Switch to the Test Level at Starting Phase Angle = 180°, and maintain for Test Duration
  - Switch to the Default/Standby Test Level, and maintain for Interval Between Tests
  - Switch to the Test Level at Starting Phase Angle = 180°, and maintain for Test Duration
  - Switch to the Default/Standby Test Level, and maintain for Interval Between Tests
  - Switch to the Test Level at Starting Phase Angle = 180°, and maintain for Test Duration
  - Switch to the Default/Standby Test Level, and maintain for Interval Between Tests
  
- Do not allow a new test sequence to start until Interval Between Tests has elapsed
- End of test sequence

## **Other Preprogrammed Test Sequences -- Line Qualification**

See Waveform Verification Section

---

## PQF Waveform Verification

IEC 1000-4-11 requires that the simulator output be verified periodically. For Dip & Interrupt test simulators, it is necessary to verify the voltage transition levels, transition times to 100%, and the inrush current capability. Most modern oscilloscopes are capable of observing the voltage levels and transition times. Transition times are measured with a 100-ohm, 600-watt load. For verifying the inrush current, a bridge rectifier, suitably rated 1700uF capacitor, and appropriate current transformer (Pearson<sup>8</sup> model 110 or equivalent<sup>9</sup>) are required.

The Line Qualify test sequences meet the IEC 1000-4-11: 1994 standard for qualifying the “Test generator peak inrush current drive capability”. These test sequences require the use of a standard line qualification test load, “an uncharged capacitor whose value is 1700 µF in series with a suitable rectifier” (from IEC 1000-4-11: 1994, Clause 6.1.2). The two preprogrammed test sequences for verifying the peak inrush drive current capability of the test generator are:

Line Qualify 90°  
Line Qualify 270°

Common characteristics of the “Line Qualify” test sequences are:

- Default/Standby Test Level = 0% (open circuit)
- Test Level = 100%
- Test Duration = 10 periods
- Interval Between Tests = 120 s (user selectable)
- Number of Tests = 1 (user selectable)

And the “Line Qualify” test sequence consists of the following steps:

Start at Default/Standby Test Level (open circuit)  
Switch to Test Level at the Starting Phase Angle defined by the test sequence name  
Maintain Test Level for Test Duration  
Switch to Default/Standby Test Level (open circuit)  
End test



### WARNING!

**The Line Qualification Load will draw significant current; it should be plugged into the EUT outlet only when no voltage is present -- EUT switch OFF. DO NOT plug the Line Qualification Load into a live outlet as an arc may result which might damage the outlet.**

**The charged capacitor requires a time to discharge after each test. The time allowed should exceed 7 time constants (seven times value-resistor {in ohms} times value-capacitor {in farads}). Failure to allow sufficient time to discharge may give invalid readings. Allow the Line Qualification Load to discharge -- EUT switch OFF -- before handling.**

---

<sup>8</sup> Pearson Electronics, Inc., 1860 Embarcadero Rd., Palo Alto, CA 94303 USA

<sup>9</sup> The Imon output of the **EMCPro PLUS** can be used for this measurement.

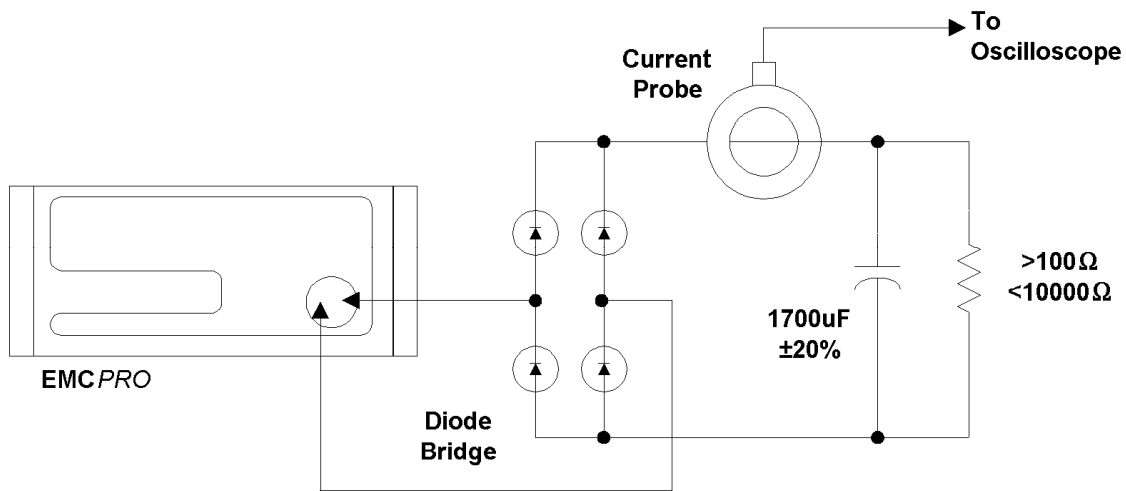

Line Qualification Test Setup -- Mains Peak Current

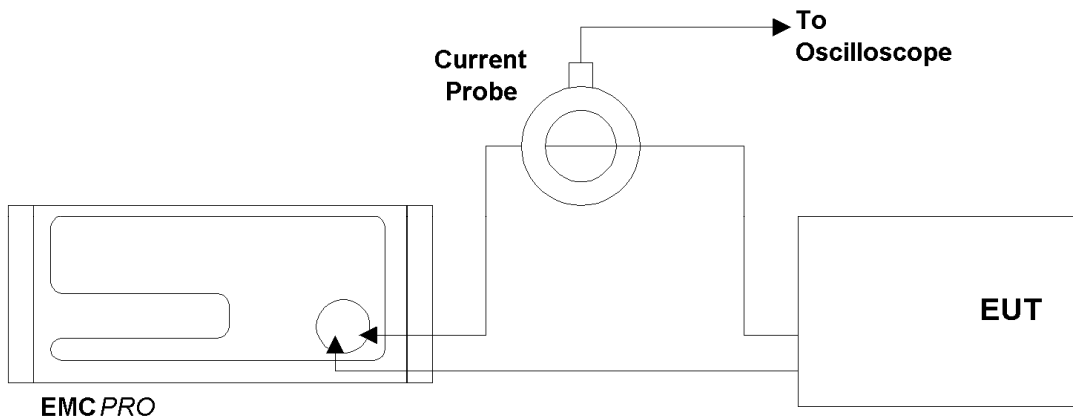

Line Qualification Test Setup -- EUT Peak Current

## Overview of the software

**CEWare** is the **EMCPro PLUS**'s PC control software. It provides full access to all the features and capabilities available from the **EMCPro PLUS** front panel, including running a single test and running a pre-defined test sequence.

In addition, **CEWare** includes a number of useful features. It allows a user to:

- Create tests and easily edit them.
- Chain test sequences together. Multiple test sequences can then combine test types (e.g. do one or more Surge tests followed by one or more EFT tests, etc.).
- Store and recall tests and test sequences to disk.
- Log tests-- print or file a list of the tests which are executed.
- Develop tests off-line, and run in a simulation mode.
- 

Note: Version 4.0 (or greater) of **CEWare** is required for use with the **EMCPro PLUS**.

A Help file for **CEWare** is provided with the software which can be opened by clicking Help|Contents on the menu bar. It provides complete operating instructions for the program; using the Help file while experimenting with the program is the recommended method for learning the software. Written instructions provided here are largely duplicated in the Help file.

The CM-SW option, available as a purchased **EMCPro PLUS** option, includes the **CEWare** program. It may be used on a Personal Computer (PC) running Windows™ 95 or more recent Windows™ versions. (Windows 3.1 is no longer compatible with current releases.) The computer must have at least 16MB of RAM and a 80486/66MHz or faster processor. Screen transitions are slower on 486 processors, thus Pentium computers are recommended. **CEWare** is designed for an 800x600 display driver. You should select such a driver (or one with greater resolution) in your Windows configuration. On a driver with a smaller display, scrolling is necessary to see the entire application screen.

The CM-SW option includes an RS-232 to optical converter (the FC-11), a short RS-232 cable with a 9-pin D-shell connector, and a fiber optic cable with a duplex modular connector. The RS-232 connector connects to a Com port on your computer. The fiber optic cable connects to the **EMCPro PLUS** front panel; this connector is polarized and can only be inserted in one orientation: with the small tab on the connector facing right. Do not force the connector. The FiberCom option derives power from the RS-232 port of the computer -- no external power source is required.

---

# Basic Operations Under CEWare

The following steps will take you through major operating modes of the program and will acquaint you with the screens. Refer to the next section for full description of all the controls and displays on the screens. These steps can be run in simulation mode or with a **EMCPro PLUS** connected. If the **EMCPro PLUS** is connected and powered on, the application will send commands to the **EMCPro PLUS**.

## Starting the Program

- Start the **EMCPro PLUS** by powering it on and pressing a key to move beyond the warning screen.
- Start the **CEWare** program from the Start menu (PROGRAMS | Thermo KeyTek **CEWare**), or from any shortcut that you create.

## Defining a Test

- Click on one of the New Sequence buttons at the left of the Main Screen to create a new test.
- Select "User-defined" from the box on the New Sequence Definition screen. The other items on that screen are defaults (the same ones as on the **EMCPro PLUS** front panel) and can be left alone or changed, as you wish.
- Click "OK" on the Custom Sequence Wizard screen to accept the Wizard defaults. This screen allows you to create several tests of the same type quickly.
- Click "OK" on the Sequence Editor Screen to accept the test sequence. This screen allows you to manually edit the order of the tests or the test parameters.
- Back on the Main Screen, you now have one sequence defined and shown in the grid. You can return to the Sequence Editor at any time by double-clicking on the row or row number of the sequence you wish to edit.
- On the Menu bar at the top of the screen, select FILE | SAVE if you want to save your test.

## Running a Test

- Click on the RUN button to start the test. The grids on the Run Screen, and the Status Block at the lower right, will show the status of the executing tests.
- Hit the ABORT button to return to the Main Screen. After test completion, a notice is displayed, and return to the Main Screen is automatic on acknowledgment of the notice.
- Exit the application by choosing FILE | EXIT from the main application menu.

---

## Additional Operating Notes

- **Remote mode.** While the PC **CEWare** program controls the **EMCPro PLUS** the normal idle screen contains a "Comm: Remote; Status: Idle" indication if no test is running. When a test is active, a Run Screen (the same as from front panel control) will be shown on the front panel display. If the EXIT button on the front panel is pressed when in "Remote Idle," the **EMCPro PLUS** will no longer be controlled by the PC. This is not recommended. Termination of tests and remote control from the **CEWare** menu is preferable. (ESD test operation is a special case; see the next item.)

- **ESD operation.** The ESD test function is designed for maximum control at the ESD head. **EMCPro PLUS** operation puts the unit in a "Test Run" state, where it will stay until the user hits EXIT on the front panel. The same front-panel control is in place when running from **CEWare**. Leave the ESD run state by hitting EXIT on the front panel when all ESD pulsing is done. You may also select ABORT from **CEWare**, but this will terminate the entire sequence.

If your **EMCPro PLUS** does not have a front panel, the ABORT from **CEWare** is the only mechanism for stopping an ESD test. For this reason, putting an ESD test in a sequence with other test types is not recommended in that configuration.

During ESD tests, the user may perform more tests than are defined in the sequence definition; for this reason, the **CEWare** screen may show tests executed greater than the total tests, such as "140 of 100" pulses.

- **Mouse operations.** If running Windows 3.1 with the "snap-to" option enabled on the mouse driver (see the Mouse driver selections on the Windows Control Panel), the mouse cursor may jump when the mouse button is pressed. Turn off "snap-to," if it is enabled. Not all mouse drivers support "snap-to."

- **Editing pre-programmed surge tests.** Some of the pre-programmed surge tests (pre-qualification and Level 1) include voltages which are below the normal limit for surge user-defined tests. These tests will run as pre-programmed tests, but not as user-defined tests. If you edit these pre-programmed tests and attempt to run without changing the voltages, **CEWare** will report errors at each voltage below the normal limit. If these low-voltage, pre-programmed tests are edited, be certain to remove or change all the voltages below the 200V limit.

- **Test timing counts.** The test count displayed on the **CEWare** screen is a combination of values from **CEWare** timing and firmware timing. It may sometimes change quickly, faster than a normal clock, or lag the front panel count, due to communication delays. The test is being executed by the firmware, and the front panel has the most current information for each test. Only **CEWare** supports user-defined sequences and combinations of sequences; timing information is summarized in the Sequence List Status block, as described in other sections of the manual.

---

## CEMaster/EMCPro PLUS Differences

### CEWare Support of EMCPro PLUS and CEMaster differences

The standard test sequences supported on **CEMaster** and **EMCPro PLUS** are not identical. This is largely due to the higher voltages and additional test types of the **EMCPro PLUS**. While CEWare version 2.0 and higher supports both products, there are certain incompatibilities when using these standard sequences.

### Using CEMaster standard sequences with the EMCPro PLUS

Most standard sequences created in CEWare for use on the **CEMaster** can also be used on the **EMCPro PLUS**. The exceptions are those containing at least one of the following Surge (1.2/50) sequences:

- PreQual A*
- PreQual B*
- Class 1 Fast*
- Class 1 Full (formerly called Class 1 Complete)*
- Class 2 Full (formerly called Class 2 Complete)*

While neither of the **CEMaster** prequalification sequences are available on the **EMCPro PLUS**, the *Class 1 Fast* sequence is the same as the **EMCPro PLUS** sequence *Class 1 Full*, and therefore a direct substitution can be made. Note, however, that the new suite will not run on a **CEMaster**. Also note that the **CEMaster** *Class 1 Full* and *Class 2 Full* sequences are not the same as those sequences with the same names on the **EMCPro PLUS**.

### Using EMCPro PLUS standard sequences with the CEMaster

Many standard sequences created in CEWare for use on the **EMCPro PLUS** can also be used on the **CEMaster**. The exceptions are those containing at least one of the following sequences:

- EFT Class 4*
- HPulse Class 5*
- Surge (1.2/50) Class 1 Full*
- Surge (1.2/50) Class 2 Full*
- Surge (1.2/50) Class 4 Fast*
- Surge (1.2/50) Class 4 Full*
- Surge (10/700), all sequences
- Surge (Ring), all sequences

Note that the **EMCPro PLUS** *Class 1 Full* and *Class 2 Full* sequences are not the same as those sequences with the same names on the **CEMaster**. However the **EMCPro PLUS** *Surge(1.2/50) Class 1 Full* sequence is the same as the **CEMaster** sequence *Surge(1.2/50) Class 1 Fast*, and therefore a direct substitution can be made. Note, though, that the new suite will not run on an **EMCPro PLUS**.



---

## EMCPro and EMCPro PLUS Differences

### EFT Burst Duration

The EMCPro PLUS controls burst duration in accordance with IEC standard 61000-4-4 Edition 2. That standard specifies that the burst duration differ depending on the pulse frequency (5kHz or 100kHz). The burst duration is controlled by the firmware in the tester and is not accessible from user controls. It is observable only by instrumentation of the EFT output. All tests, including pre-programmed tests stored by CEWare and ported from one machine to the other, will therefore run differently on the two machines, according to the design of each.

### PQF Pre-programmed Tests

Edition 2 of IEC 61000-4-11 specifies recommended test levels in different terms depending on the power line frequency. All models allow user control of dip duration by both time and cycle count. But only the **EMCPro PLUS** and not the **EMCPro** has pre-programmed tests specified by line cycle timing.

## Changing Program Settings

Program settings - defaults - affecting communications, data logging, and user-defined messages, may be changed from the menu bar; the setup option. [See the Menu, Toolbar, and Status Bar section for more detail.](#)

• **Viewing, editing, and printing test reports outside CEWare.** Test logs may also be viewed, edited, and printed using a word processor. The following document format controls are appropriate for MicroSoft Word. Equivalent margin and font selections are likely to be necessary from other word processors.

1. Start MS Word and select the text log file you wish to print from FILE

- OPEN.

2. Select all of the text in the document

3. Select FORMAT - FONT

- Select Font = Courier New, MS LineDraw, or Lucida Console
- Select Font Style = Regular
- Select Size = 10
- Select OK

4. Select FILE - PAGE SETUP

- Set Margins Left = 0.9"

- 
- Right = 0.9"
  - Top = 1.0"
  - Bottom = 1.0"
  - Select OK

5. If you wish to Print, select FILE - PRINT

# CEWare in Detail

## Screens and Organization

**CEWare** uses five screens to create, edit, and run tests. The material on the screens is described in the following sections. This information is also contained in the Help file.

**Main Screen** -- The overview screen; used to create and run tests.

**New Sequence Definition Screen** -- Used to define a test sequence, selecting pre-programmed or custom (user-defined) tests.

**New Custom Sequence Wizard Screen** -- If a User Defined test sequence is selected, the Custom Sequence Wizard will help define the sequence of tests.

**Sequence Editor Screen** -- Used to modify a test sequence.

**Run Screen** -- Shows Test Status information while tests are running.

**Sequence List Description**

**New Sequence**

- ESD
- EFT
- Surge 1.2/50
- HPower
- HPulse
- PQF
- Surge Ring

| Sequence | Type       | Sequence Description |              |
|----------|------------|----------------------|--------------|
| 1        | PQF        | Standard             | Combination  |
| 2        | Srg 1.2/50 | Standard             | Class 1 Full |
| 3        | EFT        | Standard             | Class 4      |

**List Repeats**: 0

**Run** **Abort** **EUT POWER OFF** **Break** **Comment**

**Sequence List Status**

Sequence: 0 of 3  
Duration: 0  
Elapsed Time: 0  
Repeat Count: 1 of 0

**Present Sequence Status**

Test: 0 of 0  
Duration: 0  
Elapsed Time: 0  
Repeat Count: 1 of 1

Communication: **DISCONNECTED** LOCAL Run State: **IDLE** Logging: **OFF**

---

## Main Screen

The Main Screen is the screen used to create tests, load or save tests, and run tests.

To create a new test, click on one of the seven test buttons, left-center on the screen. To load an existing test, click on the Toolbar or Menubar at the top of the screen. To Run a test click on the RUN button at the bottom left of the screen. The following sections describe the information and the controls on the Main Screen.

### Toolbar

The toolbar at the top of the screen supports some system-level operations. It is described in detail in the section on Menu, Toolbar, and Status Bar, which appear on several screens.

### Test Status Block

When on the Run Screen, the Test Status Block shows which test is currently executing, and shows duration and elapsed times. While displayed on the Main Screen, this block is updated when a test sequence is selected or deselected on the Sequence List grid. It is described in detail in the section on the Run Screen.

### Test Control Block

The test control block has control buttons to start, stop, and control tests.

- **RUN**            The Run button starts the Test. Once the test is running, the Run button becomes the Pause button.
- **PAUSE**            (Only enabled on Run Screen) -- Click the Pause button to temporarily halt the test.
- **RESUME**            (Only on Run Screen, when in Paused state) -- Click to resume a paused test.
- **ABORT**            The Abort button Halts the test.
- **BREAK**            The Break button 'breaks' out of loops.  
  
When you click the Break button, if the Present Sequence Status has a repeat count greater than one, it drops to one. Any test presently executing continues to completion, but at completion the present test ends.  
  
If the Sequence List Status has a repeat count greater than one, it drops to one. Any test presently executing continues to completion, but at completion the present test ends; at completion of all tests in the present sequence, the present sequence ends.
- **COMMENT**            The comment button is only active when logging is set to ON. This Comment button allows definition of a user comment while tests are running. The comment can then be inserted into the log file at any instance the user chooses by selecting the OK button on the comment entry window.
- **AUTO PAUSE/REPEATS Checkboxes**

---

Enable steps and defined sequence repeats.

When checked, AUTO PAUSE will enable any pauses defined in the Sequence Editor. At each pause the operator must click the OK button on a Windows prompt box to continue the test. When un-checked, any pauses defined in the Sequence Editor are ignored. When checked, REPEATS will allow any repeats defined in the Sequence Editor and in the main menu. When un-checked, any repeats are ignored; each test and sequence will execute exactly one time. (This is the mechanism for single-stepping, used in coordination with the Pause column on the Sequence Editing screen.)

- EUT POWER STATUS

The EUT Power status button shows the EUT status. The EUT power may be turned off from the computer by clicking this button. When off, the EUT Power can only be turned on from the **EMCPro PLUS**, by turning the EUT switch ON, or toggling OFF and ON.

### Sequence List Grid

The Sequence List Grid shows which test sequences have been defined (or loaded with the current file). The grid allows editing the sequence during the definition and editing phases. A yellow highlighted bar identifies the test to be edited when using CUT, COPY, and PASTE.

- To Edit a Test Sequence:  
Double-click on the gray, numbered, row-header cell to the left of the test you want to edit, or anywhere in the row of that test. The Sequence editor will open.
- To Add a Test Sequence to the end of the sequence list:  
Deselect any selected Test Sequences by clicking the button in the upper-left corner of the grid. Then, click a test type button.
- To Insert a Test Sequence:  
Click the gray numbered cell to the left of the test you want to insert the new sequence in front of. Then select a test type by clicking a test type button.
- To Delete a Test Sequence:  
Click the gray numbered cell to the left of the test you want to delete. Then click the Cut button from the toolbar.
- To Move a Test Sequence:  
Click the gray numbered cell to the left of the test you want to move. Click the Cut button from the toolbar to remove this test. Click the gray numbered cell to the left of the test you want to insert the cut sequence in front of. Then click the paste button from the toolbar to insert the test.

---

### Test Type Controls

These 7 buttons at the left of the Main Screen select a test type to create. There are 8 different immunity tests available, in accordance with European Norm requirements and the controlling, basic EMC immunity standards of:

|               |                                   |
|---------------|-----------------------------------|
| IEC 1000-4-2  | ESD                               |
| IEC 1000-4-4  | EFT                               |
| IEC 1000-4-5  | Combination and Telcom Wave Surge |
| IEC 1000-4-8  | Power Frequency Magnetic Field    |
| IEC 1000-4-9  | Pulse Magnetic Field              |
| IEC 1000-4-11 | Dip and Interrupt                 |
| IEC 1000-4-12 | 100kHz RingWave for AC Mains      |

The tests available on your system will depend on the options installed in your **EMCPro PLUS**. If a test is not available, the corresponding test button will be grayed out, and cannot be selected. The legend on the last button will depend on the surge option installed in the system.

### Repeat Control

The repeat control sets how many times the sequence shown in the Sequence List grid will be executed. Click this control and enter a number.

### Test Description

If a test is loaded from a file, the description box will contain the text description filed with the test. If a new test is created, enter a description of the test in the description box for inclusion in reports and logfiles, and to be saved with the test.

### Tool Bar

The toolbar holds icons for common tasks, allowing you to select that task with a single mouse-click. See the section below on the Menu, Toolbar, and Status Bar.

- File Icons -- The file icons create a new test sequence, load an existing test sequence, or save the current test sequence. If you attempt to create a new sequence or load an existing sequence, you will be prompted to save any existing work.
- Edit Icons -- The CUT, COPY, and PASTE icons allow you to edit the test sequence grid. These icons are also found in the Sequence Editor.
- The Printer icon will print the test sequence.

### Starting a Run

When you wish to execute the presently defined sequence list, select the Run button in the Test Control area. A Windows message box will appear to inform you if you are doing a Local/Simulation run. If you are about to do a Remote run (connected to a **EMCPro PLUS**) no warning is given.

If Logging is enabled, a Run-Time Logging Information screen will appear. In it you will see the header information that will appear in the log report(s). This information can be edited.

You may edit the 60 character log report header line or the 40 character operator name. There is a 60 character field for a description of the equipment under test and a text entry field where you can make any comments regarding the run before you begin. The comment will appear after the header on the first page of the log text report.

Enter up to 8 characters for the file name for either or both of the log report types selected. This must be a valid 8 character DOS filename. The file paths and extensions are shown for reference only and are not editable in this window.

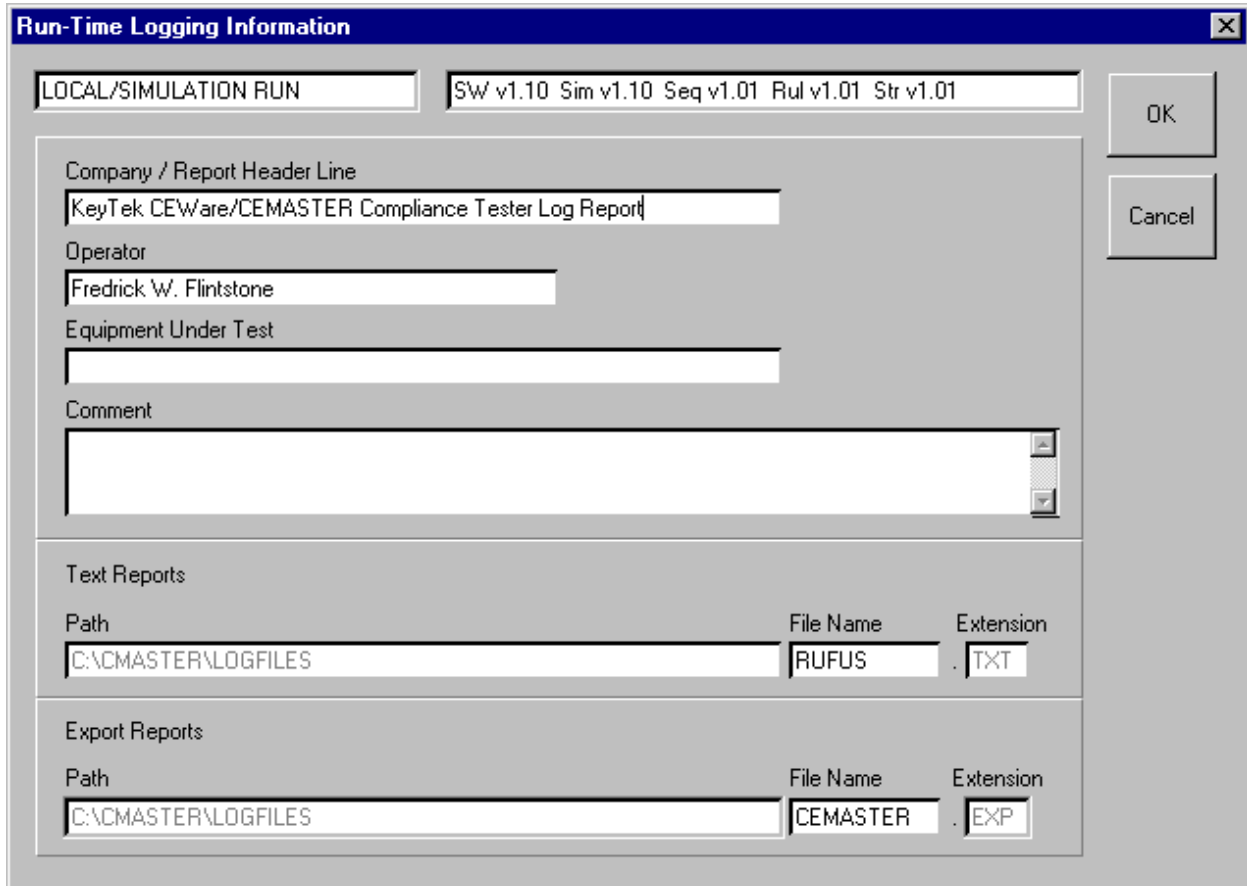

The image shows a Windows-style dialog box titled "Run-Time Logging Information". At the top, there are two text boxes: the first contains "LOCAL/SIMULATION RUN" and the second contains "SW v1.10 Sim v1.10 Seq v1.01 Rul v1.01 Str v1.01". To the right of these are "OK" and "Cancel" buttons. Below this is a section for "Company / Report Header Line" with a text box containing "KeyTek CEWare/CEMASTER Compliance Tester Log Report". Underneath are fields for "Operator" (containing "Fredrick W. Flintstone"), "Equipment Under Test" (empty), and "Comment" (a large empty text area). The next section is "Text Reports", which has three sub-fields: "Path" (C:\CEMASTER\LOGFILES), "File Name" (RUFUS), and "Extension" (.TXT). The final section is "Export Reports", also with three sub-fields: "Path" (C:\CEMASTER\LOGFILES), "File Name" (CEMASTER), and "Extension" (.EXP).

**Run-Time Logging Information Screen**

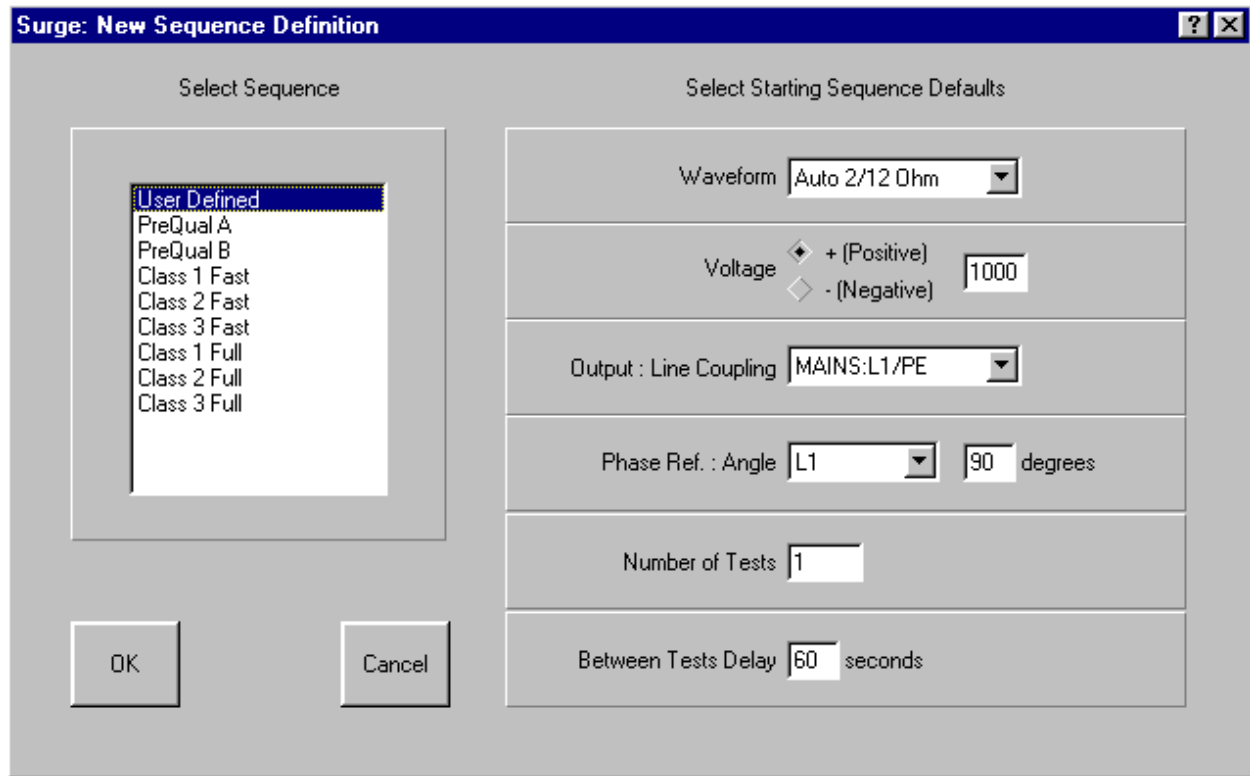

### New Sequence Definition Screen

#### New Sequence Definition Screen

The New Sequence Definition Screen is opened when you create a new test (by clicking on one of the test type buttons from the Main screen).

The list box to the left of the screen shows available sequences. The User Defined sequence gives you the most control over the test, allowing you to define all of the Sequence Defaults shown on the right side of the screen. The other options shown -- which vary by test type -- are test sequences which the **EMCPro PLUS** has stored and available. These sequences speed set-up and execution of commonly performed IEC test sequences by setting and locking many of the defaults. Locked defaults will be grayed, and cannot be selected. The standard test sequences for each test type are described in the **EMCPro PLUS** manual.

To continue, click one of the sequences shown. If the Sequence Defaults to the right of the screen are enabled, you can select one or more of the Defaults. Finally, click OK.



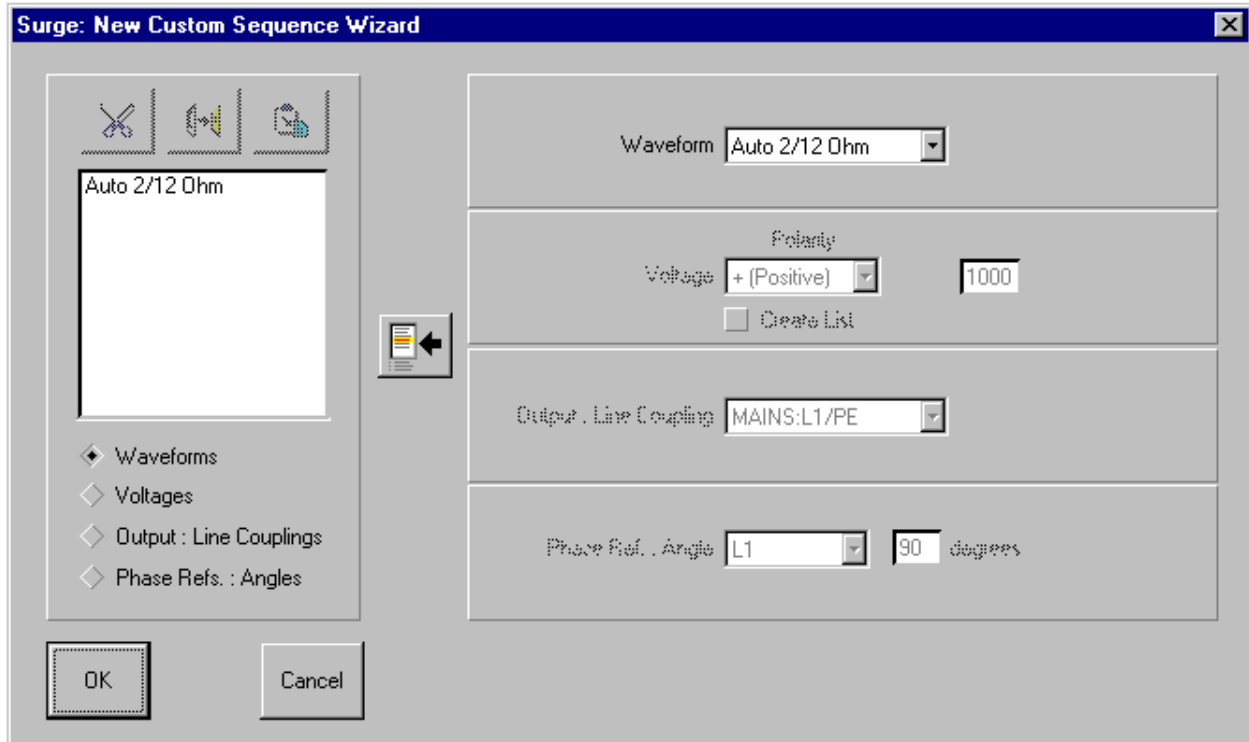

### New Custom Sequence Wizard Screen

### New Custom Sequence Wizard Screen

The New Custom Sequence Wizard screen quickly creates test sequences. The Wizard is run automatically whenever you select a User Defined Sequence in the New Sequence Definition Screen. The Wizard allows you to create lists of one or more parameters, then forms all combinations of these parameters to quickly create a large number of tests. When you click OK, the Wizard closes and the Sequence Editor opens for fine editing of test parameters.

To use the Wizard, select one of the radio button options at the bottom left of the screen, or click within any parameter definition box to the right of the screen. The defaults in the combo boxes are those you selected from the New Sequence Definition Screen. Make a parameter selection, then click the Insert button (to the left of the parameter definition boxes) to copy the selection into the list box. You can change list boxes using the radio buttons below the list box, and edit the list box using the CUT, COPY, and PASTE buttons above the list box.

For example, if you click Voltages, and insert 250V, 500V, and 1000V, then click Output and select L1-L2 and L1-PE, when you exit the Wizard, the Wizard will create six tests:

- L1-L2 at 250V
- L1-L2 at 500V
- L1-L2 at 1000V
- L1-PE at 250V
- L1-PE at 500V
- L1-PE at 1000V

If you want to create a User-Defined test sequence with a single test, simply click the OK button to exit the Wizard and open the Sequence Editor.

### Sequence Editor Screen

The Sequence Editor is opened after selecting a test sequence from the New Sequence Definition Screen, or by double-clicking an existing test from the test on the Main Screen. The sequence editor gives you fine control over what tests are performed and all options. If you wish to execute a predefined test with no changes, you should simply click on the OK button. If you make any changes in a predefined test, the test will be re-defined as a User Defined test.

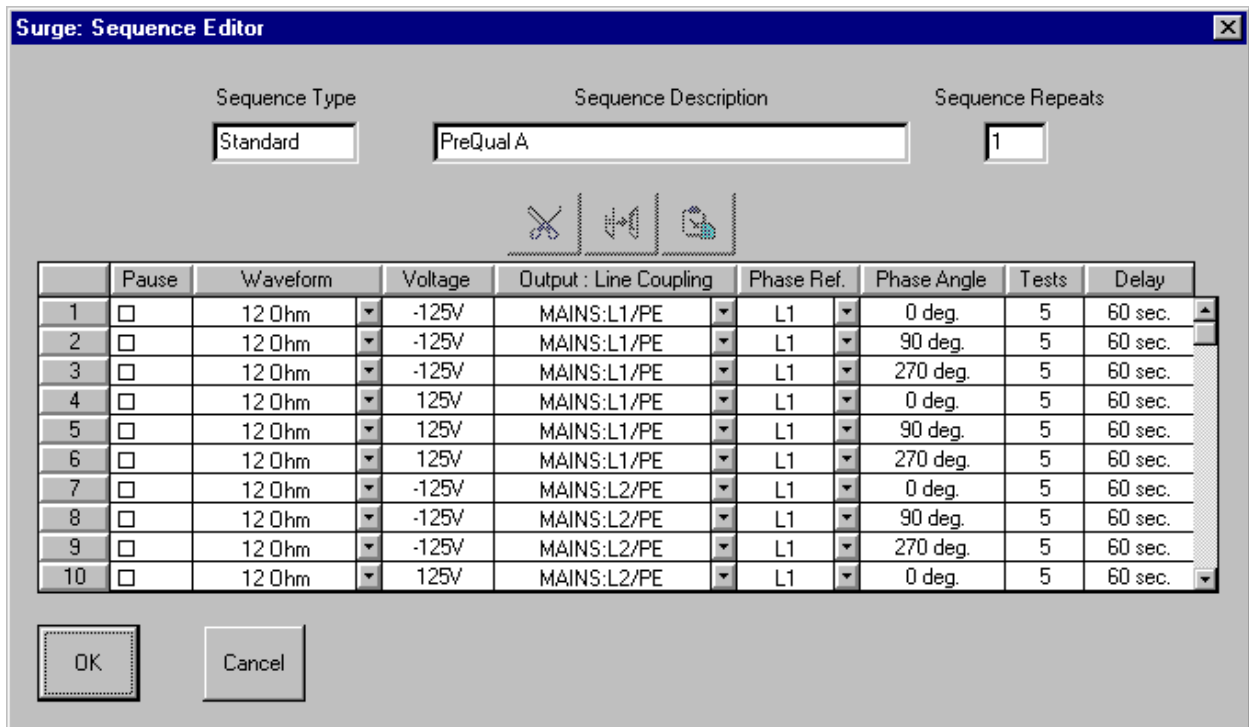

Sequence Editor Screen

---

## Sequence Description Grid

The Sequence Description Grid shows which tests have been defined in a sequence. It supports the editing process on the Sequence Editing Screen as well as allowing the data to be changed in any individual cell. Basic test editing is allowed on any test in the grid. Text cells can be changed by selecting a cell, deleting the current entry, and typing a new one. Cells that support a list of legal values have a standard Windows drop-down list controlled by the drop-down button at the right of the cell. Open the list and select a new value to change it. Additional editing controls that affect more than one cell are also supported and are described in more detail below.

- **PAUSE or PAUSE AND DISPLAY MESSAGE Control**

The PAUSE column of this grid allows single-stepping or automatic stopping at any test in the sequence. Check the box in the row of the test where you wish to pause. (The pause will occur before the test executes.) Make sure that the Auto Pause box is checked, on the Main Screen, before the test starts. The PAUSE box for all tests in a sequence may be set with the technique described in this section for changing an entire column.

To set or reset the PAUSE box, use a single left button click of the mouse to select the PAUSE cell then use single left button clicks to set or reset the check-box in the cell. A message can be displayed during a PAUSE - see the Message Selection section.

A yellow highlighted bar identifies the test to be edited when using CUT, COPY, and PASTE, which act on entire test rows.

- **To Delete a Test Sequence**

Click the gray, numbered cell to the left of the test you want to delete. The entire row will be highlighted. Then click the CUT button from the toolbar.

- **To Move a Test Sequence**

Click the gray, numbered cell to the left of the test you want to move. Click the CUT button above the grid to remove this test. Click the gray numbered cell to the left of the test that will follow the moved test. Then click the PASTE button from the toolbar to insert the test.

- **To Copy a Test Step**

Click the gray, numbered box to the left of the test you want to copy; the entire row will be highlighted. Click the COPY button.

- **To Paste a Test Step**

---

After a Cut or Copy operation, click the gray, numbered box to the left of the test you want to insert in front of; the entire row will be highlighted. Click the PASTE button. NOTE: To select a block of rows, hold the [Shift] key when left-clicking; to select multiple single rows, hold [Cntrl] key when left-clicking.

The Sequence Editor allows several special editing operations in addition to the normal Cut and Paste Operations. These operations take place over all or part of a column. This allows you to change many tests with a single editing step.

- To change an entire column

Click one cell within the column you want to change. Then, click the gray column header at the top of the grid. All cells in the column will be highlighted.

Press ENTER. The cell you highlighted will open for editing. Select a new value and press ENTER (if this is a numeric cell, type in a new value and press ENTER; if this is a check box, press ENTER to toggle).

All cells in the column -- and thus all tests within this sequence -- will take on the new value you entered.

- To change all entries in a range within a column

Click the first cell in the range within the column you want to change. Then, hold down the shift key and click the last cell in the range you want to change. All cells between the first and last cells will be highlighted.

Press ENTER. The last cell you highlighted will open for editing. Select a new value and press ENTER (if this is a numeric cell, type in a new value and press ENTER; if this is a check box, press ENTER to toggle).

All cells in the range will take on the new value you entered.

When you change a column, other columns may change as a result. These changes will always be 'legal' -- that is, the test will run with the resulting change, and you will not get an error. But the changes may not be uniform. Check the other columns to be sure the tests will run the way you want them to.

### Keyboard Editing

The grid can be edited using the keyboard cursor keys, Tab, and ENTER. Press Tab until the grid is selected -- the highlighted cell within the grid will have a dotted selection-box drawn inside it. Use the cursor keys to select a cell to edit. Press ENTER to open the cell. If the cell is a drop-down box, use the cursors to select an option. If the cell is numeric, type in a new value. Press ENTER to accept the change.

## Message Selection Grid

To assign a message to be displayed during a run-time pause, double-click the left mouse button on the desired PAUSE cell. This will bring up the Message Selection window where a single 80-character message may be selected from 200 available messages. See message editor section on adding or modifying messages.

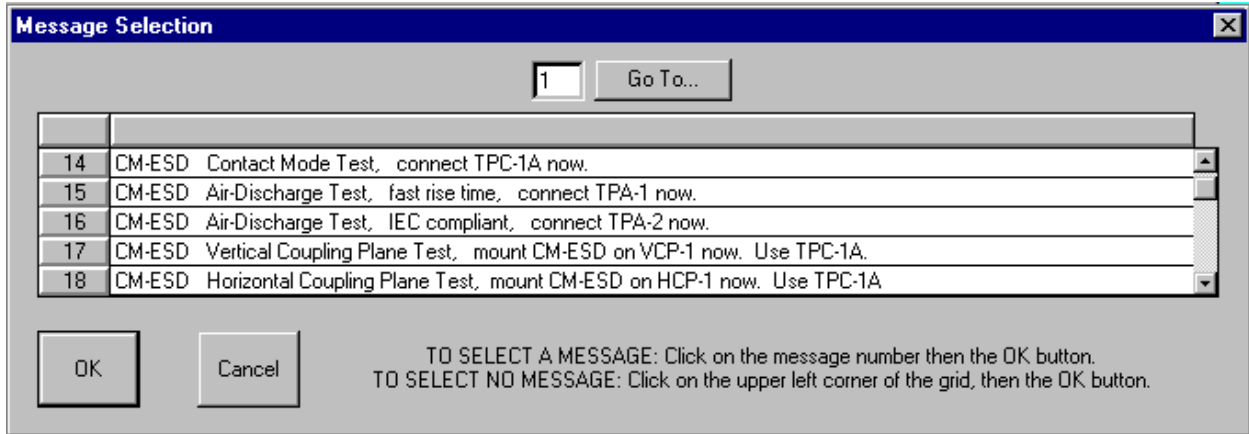

## Message Selection Screen

Use the right scroll bar to scroll through the 200 messages or enter a specific message number in the Go To... edit box then click the Go To... button.

Select the desired message by clicking on the message number button to the right of the message, then click OK.

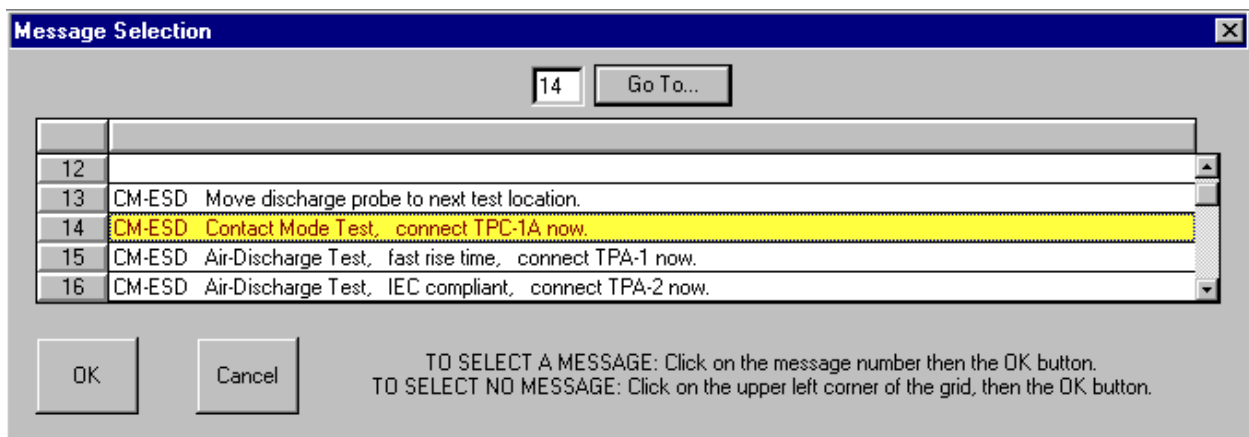

## Message Selection Screen, with message selected

When OK is selected, the Message Selection Window closes, and the message number is pasted in the PAUSE cell of the Sequence Editor Grid.

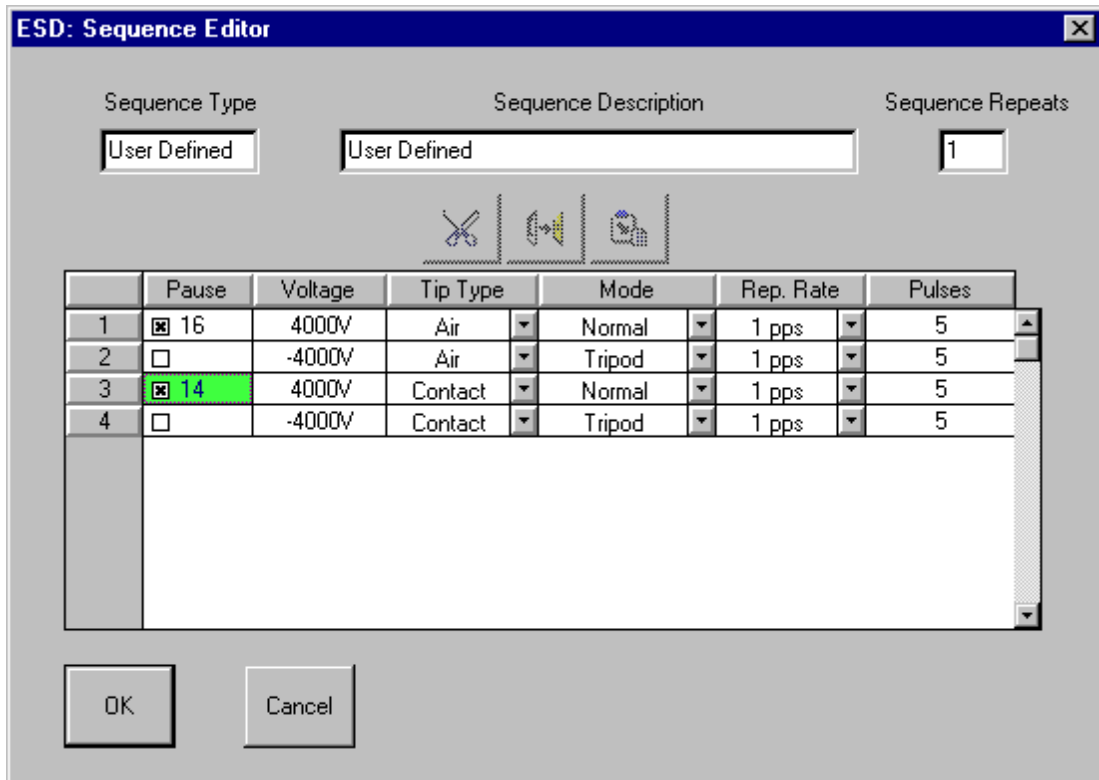

**ESD: Sequence Editor Screen**

To remove a message from being displayed during pause, double-click the left mouse button on the desired PAUSE cell. This will bring up the Message Selection window where the selected message will be displayed highlighted.

Deselect the message by clicking on the upper left corner button on the Message Selection grid, then click OK.

NOTE: The Message Selection grid does allow editing of message text but does not allow Cut, Copy and Paste operations.

## The Run Screen

The Run Screen interface is divided into several sections:

- Sequence List Description:** A text area at the top for describing the current sequence.
- Sequence List:** A table listing defined sequences. The first sequence, 'Srg 1.2/50', is highlighted in yellow.
- Present Sequence:** A table showing the details of the currently executing sequence (Srg 1.2/50).
- Controls:** Buttons for 'Pause', 'Abort', 'EUT POWER OFF', 'Break', and 'Comment'. Checkboxes for 'Auto Pause' and 'Repeats' are also present.
- Status:** Two status panels: 'Sequence List Status' and 'Present Sequence Status', both showing progress for the first of two sequences and the first of 60 tests.

| Sequence | Type       | Sequence Description |
|----------|------------|----------------------|
| 1        | Srg 1.2/50 | Standard             |
| 2        | EFT        | Standard             |
|          |            | Class1               |

|   | Pause                    | Waveform | Voltage | Output : Line Coupling | Phase Ref. | Phase Angle | Tests | Delay   |
|---|--------------------------|----------|---------|------------------------|------------|-------------|-------|---------|
| 1 | <input type="checkbox"/> | 12 Ohm   | -125V   | MAINS:L1/PE            | L1         | 0 deg.      | 5     | 60 sec. |
| 2 | <input type="checkbox"/> | 12 Ohm   | -125V   | MAINS:L1/PE            | L1         | 90 deg.     | 5     | 60 sec. |
| 3 | <input type="checkbox"/> | 12 Ohm   | -125V   | MAINS:L1/PE            | L1         | 270 deg.    | 5     | 60 sec. |
| 4 | <input type="checkbox"/> | 12 Ohm   | 125V    | MAINS:L1/PE            | L1         | 0 deg.      | 5     | 60 sec. |
| 5 | <input type="checkbox"/> | 12 Ohm   | 125V    | MAINS:L1/PE            | L1         | 90 deg.     | 5     | 60 sec. |

|              |         |    |   |
|--------------|---------|----|---|
| Sequence     | 1       | of | 2 |
| Duration     | 1:02:10 |    |   |
| Elapsed Time | 6       |    |   |
| Repeat Count | 1       | of | 1 |

|              |         |    |    |
|--------------|---------|----|----|
| Test         | 1       | of | 60 |
| Duration     | 1:00:00 |    |    |
| Elapsed Time | 6       |    |    |
| Repeat Count | 1       | of | 1  |

## The Run Screen

The Run Screen is displayed while tests are executing. A Present Sequence grid control is added to the screen, along with the Sequence List grid control. Together they describe the current set of tests being run.

### Sequence List Grid

This list of sequences is the same as shown on the Main Screen, and shows the presently defined set of test sequences. A yellow highlighted bar indicates the test sequence that is presently executing.

---

## Present Sequence Grid

The Present Sequence Grid is displayed when running tests. The grid shows all the parameters of the present test sequence, which consists of one or more tests. It is essentially the same information presented on the Sequence Edit screen. A horizontal highlighted bar across the grid identifies which test of the sequence is running.

## Test Status Block

The Test Status Block at the lower right of the Run Screen shows which test is currently executing, test duration, and elapsed times. It contains two display areas: one for the Sequence List, and one for Present Sequence -- the one that is currently executing. The two sets of data are similar. The Sequence List Status summarizes statistics for the entire set of sequences, and the current sequence within that list. The Present Sequence summarizes information about the current test within the present sequence.

- Sequence List Status

|              |   |
|--------------|---|
| Sequence     | The sequence that is running, out of the total number of sequences.   |
| Duration     | The duration shown is the estimated time required to complete the entire sequence, excluding time for pauses. The time format is hours:minutes:seconds.           |
| Elapsed Time | The elapsed time is the total time from the start of the test to the present time.  |
| Repeat Count | These fields show the present loop count, and the total list count for the sequence. The total reflects the value from the List Repeats field on the Main Screen. |

- Present Sequence Status

|              |   |
|--------------|---|
| Test         | These fields identify which test is running out of the total number of tests in the present sequence.   |
| Duration     | The duration shown is the estimated time required to complete the Present Test Sequence. The time format is hours:minutes:seconds.                                  |
| Elapsed Time | The elapsed time is the total time from the start of the present sequence to the present time.  |
| Repeat Count | These fields show the present loop count, and the total list count for the sequence. The total reflects the value from the Sequence Editor, Sequence Repeats field. |

## Test Control Block

This set of buttons is the same as on the Main Screen and is described in that section. Buttons may be enabled or not, depending on the state of the system and the software.



---

## Menu, Toolbar, and Status Bar

These areas appear on both the Main and Run Screens.

### Menubar

The menubar performs actions, sets options and preferences, and accesses the help file. The menu options are described below.



### Menubar Selections

#### File Menu

The File menu supports loading and saving of test files, and exit from the application. The default extension used for test sequence files is .SEQ.

- File | New

Delete any present tests and prepare for creating a new test. If you have tests defined and have not saved them you will be prompted to save the tests before continuing.

- File | Open

Load an existing test file. The File Common-Dialog box will open, allowing you to click on a file to load. If you have tests defined and have not saved them you will be prompted to save the tests before continuing.

- File | Save, Save As

The Save command will save the present test to a disk file. If the test was loaded from disk, the test will be written to the same file. If the test is a new test, you will be prompted for a path and filename to use in saving the test.

The Save As command will prompt you for a path and filename to use in saving the test. Use this command to create file copies of tests, or new tests based on the old ones that you have edited.

- File | Print Sequence, Print Log, Print Setup

The Print Sequence command will print the present Sequence List.

The Print Setup command controls the printer, selecting which printer is used, which font is used, and paper orientation. Print Log will allow the user to select and print a Log file.

- 
- File | File Select

This section holds the last four files you opened / saved. You can quickly load a prior file by clicking one of these selections or typing the corresponding number

- File | Exit

This selection exits from the application.

### Edit

The Edit menu allows keyboard selection of the CUT, COPY, and PASTE selections that are also accessible from the Toolbar. In addition, there is a DELETE selection which does a destructive cut of selected data.

### Setup

The Setup menu is where the user may select and set parameters for run time operation or report generation. The items on the setup menu are:

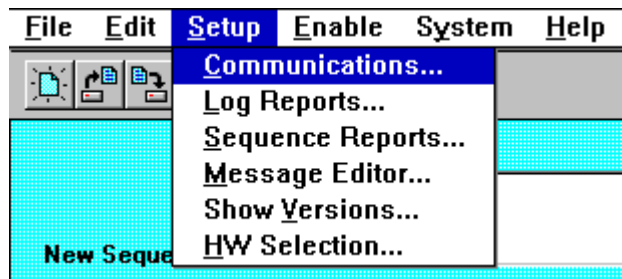

Setup menu

- Communications

The user may select the COM port to set up communications with an **EMCPro PLUS**. **CEWare** allows selections (COM1 - COM4) and automatically detects which ports are available on the system. The default selection is COM1. Other communication parameters, although shown, are fixed.

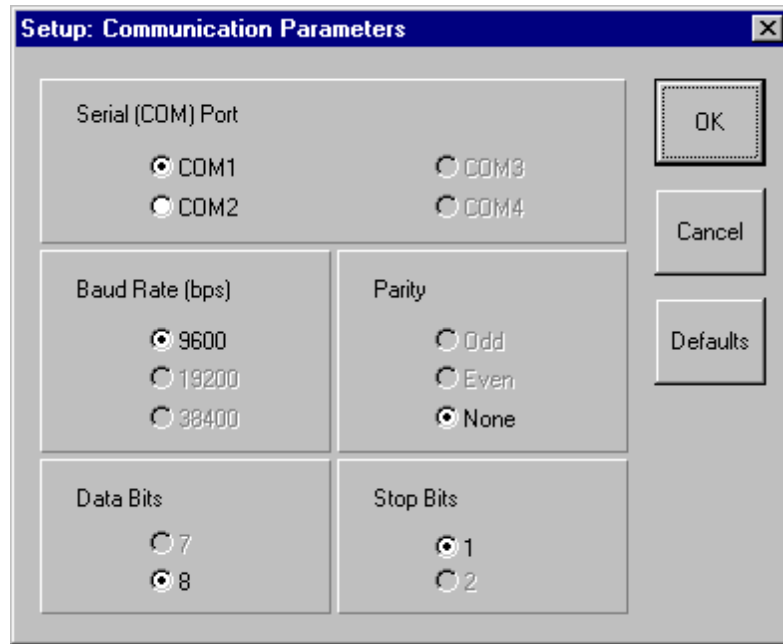

**Communication Parameters Screen**

- Log Reports

Log Reports allows the user to select the type of logging reports to produce: Text Reports or Export Reports. For each type of report, you may define your own file extension and path or you may accept the defaults (you will be asked to enter a log report file name at run time). The file extension must be a (up to) 3 character valid DOS file extension. The path must be a valid DOS path of up to 60 characters in length.

You may also define your own header line that will appear as the first line in the header of all Log reports. A default report header is supplied. You may enter a new report header of up to 60 characters.

A 40 character field is supplied where you may enter an operator name that will also appear on the Log reports.

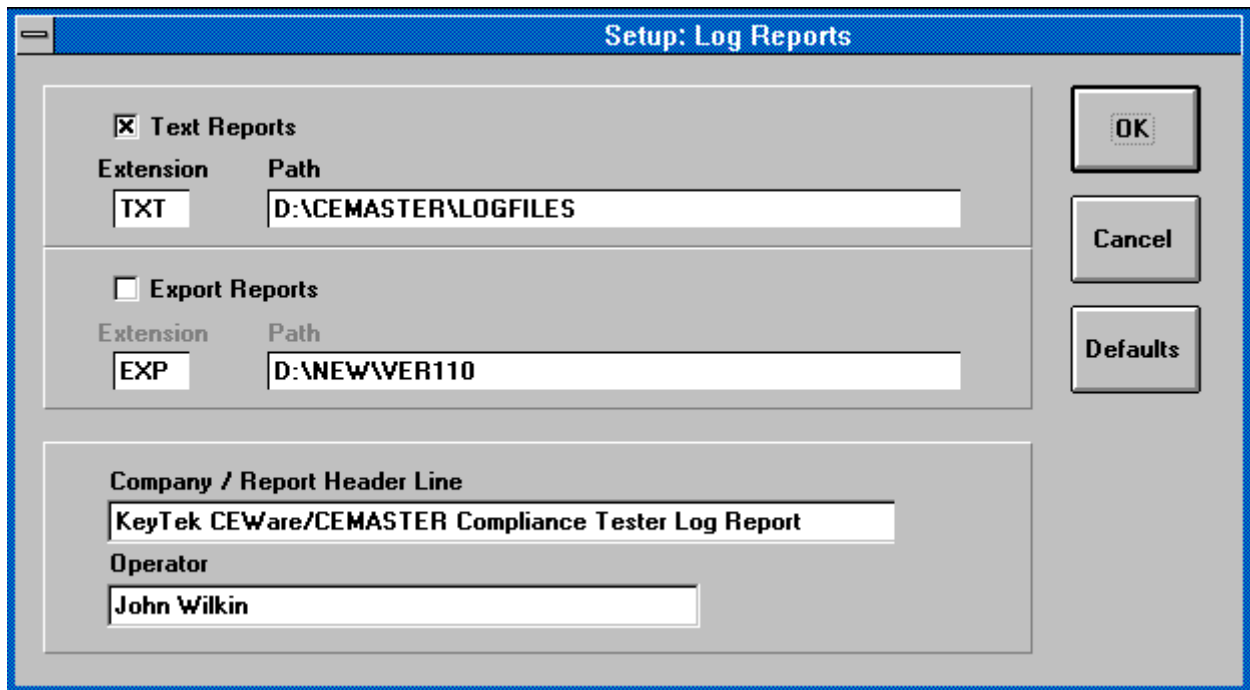

**Log Reports Screen**

- Sequence Reports

---

Sequence Reports allows the user to define his own header line that will appear as the first one in the header of all Sequence List reports. All other data for the Sequence List report is fixed. A default report header is supplied. You may enter a new report header of up to 60 characters.

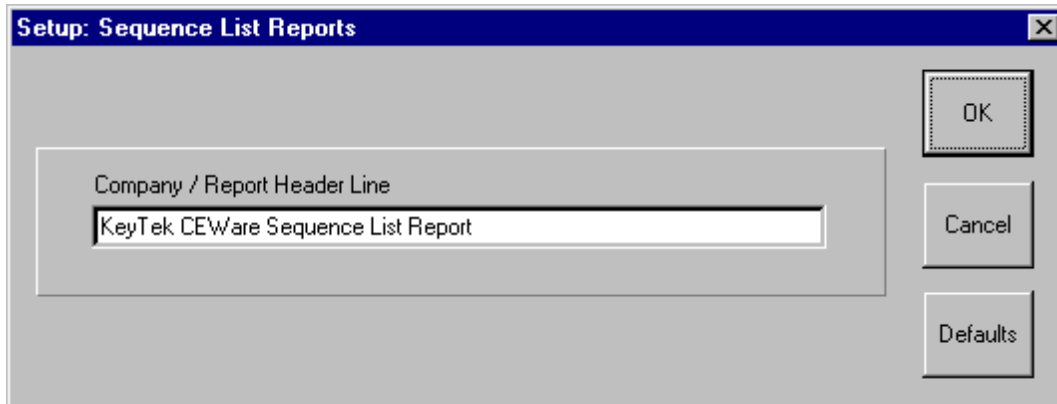

**Sequence List Reports Screen**

- Message Editor

The Message Editor allows you to define up to 200 messages that may later be attached to Auto-Pause controls on the test edit screens for display to an operator at run time. Use the scroll bar control on the right side of the message grid to scroll through the 200 messages. Each message may be up to 80 characters (maximum) in length. A set of default messages is supplied for use with several optional components available for use with the **EMCPro PLUS**. These default messages may be redefined if you desire.

To define a message, click within a message cell to highlight it (*green* highlight), then click a second time to enter “edit mode” for the cell. Enter the desired message text then press **Enter**.

To select messages for CUT, COPY, and PASTE operations, click the message number cells on the left side of the message grid. This will highlight the message in *yellow*. Multiple messages may be selected by holding the **Ctrl** key while clicking, or a block of messages may be selected by holding the **Shift** key while clicking after the first message in the block has been selected.

To deselect all messages, click the button in the upper left corner of the message grid.

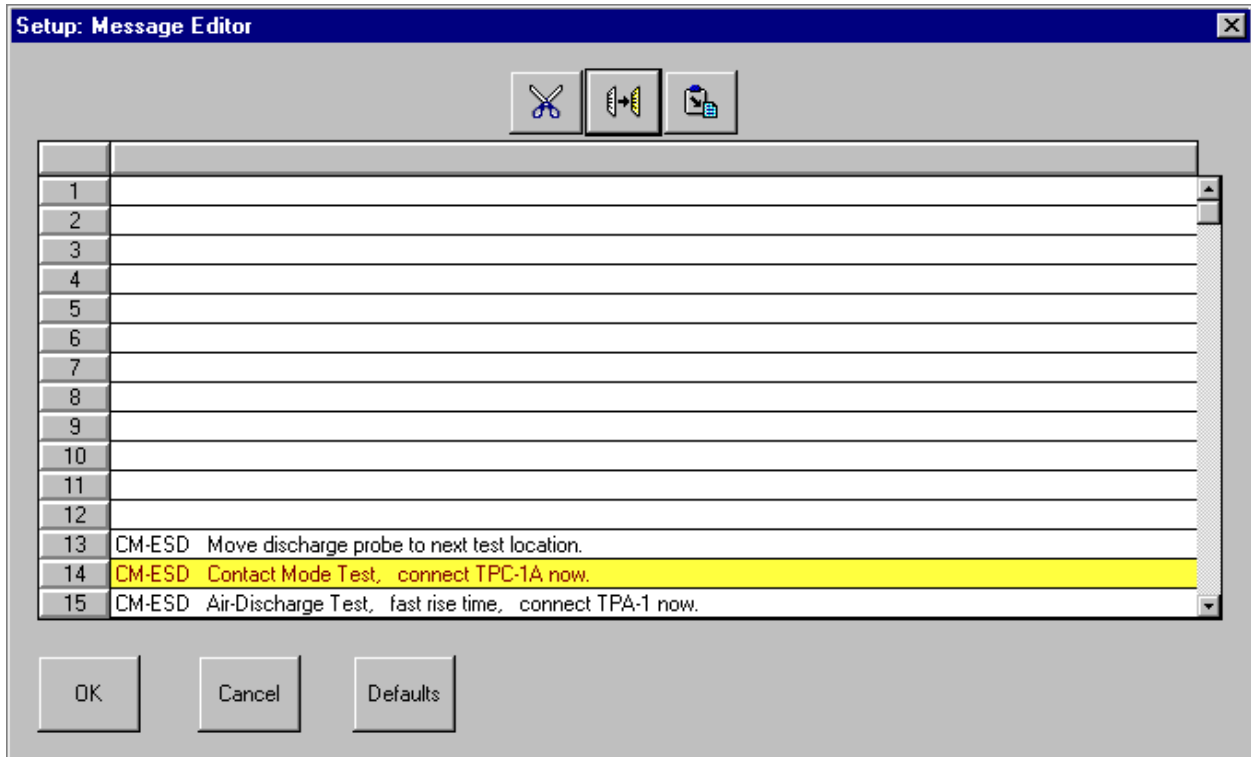

**Message Editor Screen**

- Show Versions

Show Versions is a display of the version number of the **CEWare** application, plus the version of all major software components the **CEWare** application uses. When communicating remotely with an **EMCPro PLUS**, the firmware version plus the version of all major firmware components of the **EMCPro PLUS** are also shown.

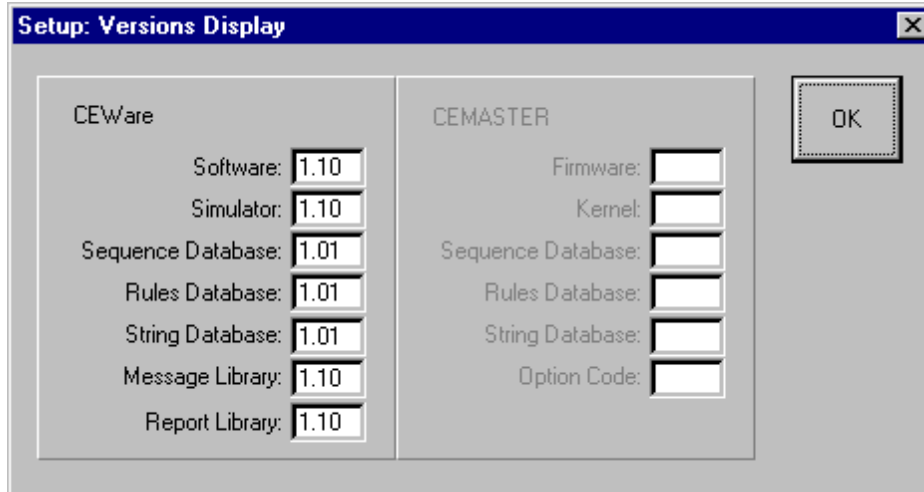

**Versions Display Screen**

- HW Selection

This selection is necessary only when running **CEWare** in local mode (with simulated hardware). The menu supports selection of test hardware type (**CEMaster** or **EMCPro PLUS**) and also of a second surge type (10/700 Telecom wave or Ring wave) if **EMCPro PLUS** is selected. Selection of this configuration information is automatic in 'Remote' mode, with hardware connected.

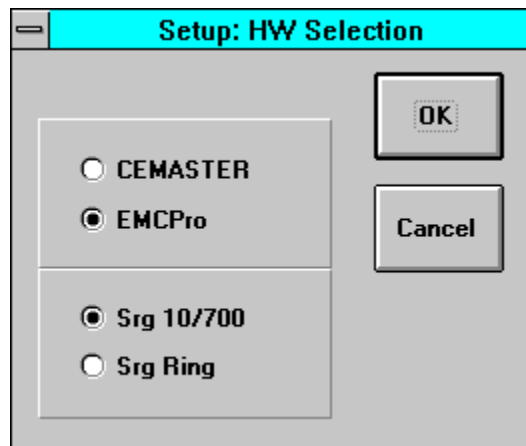

**HW Selection Screen**

Enable

---

There are two selections under Enable: *Remote Communications* and *Logging*. Both of these selections are ON/OFF selections that are indicated by a check mark when they are ON and no check mark when they are OFF.

- Remote Communications

This selection turns ON or OFF the remote (PC-based) control of the **EMCPro PLUS** by the **CEWare** application. The selection is disabled if the communications cannot be established with a **EMCPro PLUS** (communications cable not connected or **EMCPro PLUS** power is OFF). When communication with a **EMCPro PLUS** is established, this selection is enabled and **CEWare** will automatically try to turn remote control ON.

The status of communications is shown on the Status Bar at the bottom of the **CEWare** screen. When communication is not established the first item next to the “Communication:” label says DISCONNECTED. When communication is established, the label says CONNECTED.

When remote control to a **EMCPro PLUS** is enabled successfully (Remote Communications ON), the second item next to the “Communication:” label says REMOTE. When remote control is disabled (Remote Communications OFF), the item says LOCAL.

- Logging

This selection turns ON or OFF the logging feature for producing run time log reports. At least one of the two Log report types must have been enabled in Setup | Log Reports to enable logging or an error message will appear when you try to enable it. Logging may only be set ON or OFF when the Main Screen is visible: *Logging may not be turned ON or OFF once a run is started.*

The status of Logging is also shown on the Status Bar at the bottom of the **CEWare** screen. When Logging is not enabled the item next to the “Logging:” label says OFF. When Logging is enabled, the item says ON.

## System

These are debugging and field service functions which are not accessible by the user.

## Help

The Help menu brings up the Help file and shows the About box.



---

## Toolbar



### Toolbar

The toolbar holds icons for common tasks, allowing you to select that task with a single mouse-click.

- File Icons -- The file icons create a new test sequence, load an existing test sequence, or save the current test sequence. If you attempt to create a new sequence or load an existing sequence, you will be prompted to save any existing work.
- Edit Icons -- The CUT, COPY, and PASTE icons allow you to edit the test sequence grid. These icons are also found in the Sequence Editor.
- The Printer icon will print the present sequence list, i.e. it is the same as the File | Print Sequence selection on the menu bar.

## Status Bar

The status bar at the bottom of the screen gives a quick synopsis of the **EMCPro PLUS** and test status. In some cases, the status bar will be replaced with help prompts. It contains the following information.



### System Status Bar

#### Communication

- DISCONNECTED/CONNECTED

Indicates if an **EMCPro PLUS** has been detected (CONNECTED) or not (DISCONNECTED).

- LOCAL/REMOTE

When communications with the **EMCPro PLUS** are established, this indicates whether control is from the front panel (LOCAL) or from the PC (REMOTE). The program will automatically go Remote; select from the menu bar (Enable | Remote Communications) to change to simulation mode when an **EMCPro PLUS** is connected and powered on.

#### Run State

---

Shows the operating state of the **EMCPro PLUS**.

- **CHARGING**      Generating high voltage.
- **WAITING**      Between active test states, waiting for the next.
- **FIRING**        Generating an output.
- **IDLE**          No tests are running.
- **RUNNING**      Generating a continuous test state (EFT, ESD, or PFMF).

### Logging

Indicates if run time test information is being written to disk (ON) or not (OFF).

---

# Maintenance

## Service and Maintenance Issues

There are no user serviceable parts within the **EMCPro PLUS**. Service is solely by Thermo-trained, authorized technicians.

## Annual Calibration

Periodic calibration of the **EMCPro PLUS** is required. The recommended calibration interval is dependent on use. If periodic waveform verification is performed, calibration need be performed only if the waveform verification fails; if periodic waveform verification is not performed the recommended calibration interval is one year. Factory calibration is available; consult factory for terms and conditions.

## Factory Inspection and Refurbishment

Factory Inspection and Refurbishment is available. Consult factory for terms and conditions.

## Updating Firmware

There may be periodic updates of the **EMCPro PLUS** firmware or application software. Each update is provided with instructions for installation and use. An update of the **EMCPro PLUS** firmware requires the **PRO-SW** option be installed. If this option is not installed a Thermo authorized service representative is required to upgrade the firmware in the field.

If you have questions about what is the latest version of firmware, contact Customer Service.

## Upgrading Hardware Options

Most hardware options can be added in the field by a Thermo authorized service representative. Consult factory for terms and conditions.

## Decommission Issues

When decommissioning **EMCPro PLUS** equipment, the following precaution must be taken:

The **EMCPro PLUS** contains mercury relays. While the material is contained and there is no hazard in normal operation, local laws may require special consideration in disposal. Consult the factory for identification of the relays and recommendations for disposal.

---

# Troubleshooting

This section aids in finding and solving any problems you may experience. As a first step, the **EMCPro PLUS** includes diagnostic tools, accessed through the **System Menu**, and described below.

## System Menu

The System Menu gives access to several useful functions to aid in troubleshooting.

```
| SYSTEM SETUP      |||||||||||||||EUT OFF|
1. Parameters
2. Access Code
3. Diagnostics
4. Versions

||  ||  ||  ||  ||  ↑  ||  ↓  ||EXIT
```

The System menu selects special system operations; move the highlight bar using the arrow function keys and press ENTER, or press the number key associated with the sub-menu.

The **Parameters Menu** offers control of a number of system parameters, allowing customization of the **EMCPro PLUS** system. Check the menu for options available in your system; possible options are: control of the beeper; default coil factor to use; etc.

The **Access Code Menu** is not available at this time. In the future, this menu will allow locking features of the **EMCPro PLUS** system -- preventing unauthorized use.

The **Versions Menu** shows internal revisions for the code and databases used by the **EMCPro PLUS**. This information is important and should be checked whenever contacting Customer Service.

```
| VERSIONS          |||||||||||||||EUT OFF|
Firmware           ..... Vx.xx
Kernel             ..... Vx.xx
Sequence Database  .... Vx.xx  Sep 24, 96
Rule Database      .... Vx.xx  16:15
String Database    .... Vx.xx
Option Code        .... AA

||  ||  ||  ||  ||  ||  ||EXIT
```

The Version Menu shows a Build date and time, five arguments with revisions, and a code indicating the installed options.



---

## Troubleshooting Guide

In the event of a problem with the **EMCPro PLUS** please follow the procedure below.

- Verify that you have properly selected all test parameters.
- Check that the **EMCPro PLUS** is properly connected to the AC Mains.
- Check that the EUT is properly connected to the **EMCPro PLUS**.
- Check all interconnections for loose connections.
- Try cycling power to the EUT and the **EMCPro PLUS**.
- Run Diagnostics tests from the System Menu.
- Contact Customer Service for guidance.

---

## Error Messages

The following are possible error messages, their causes, and possible solutions.

### **No AC Phase Reference Detected Check EUT Power switch and EUT power**

The Surge parameters specify line sync, and no AC line was detected for synchronization.

To surge without the AC mains present, change the line sync setting from "L1" to "RND" -- random.

To surge with AC mains, check that EUT power cord is plugged in, EUT power is present, and the **EMCPro PLUS** EUT switch is on; check that EUT ON is shown on the front panel display.

**NOTE:** The minimum EUT inlet voltage for dependable line synchronization is 50Vac; operation below this value may cause this error message.

### **AC Required At Mains Output Check EUT Power switch and EUT power**

During a PQF test, AC was not present (PQF requires AC to be present).

Check that EUT power cord is plugged in, EUT power is present, and the **EMCPro PLUS** EUT switch is on; check that EUT ON is shown on the front panel display.

**NOTE:** The minimum EUT inlet voltage for dependable line synchronization is 50Vac; operation below this value may cause this error message.

### **ESD Simulator Not Connected**

An ESD test is selected, and no ESD simulator head was attached.

Attach an ESD head; check that the cable is properly connected (remove ground-return cable; if the ground-return indicator does not light on the head, there is a poor connection).

### **Interlock Open Fault Power PCB Interlock**

This fault indicates a problem with an internal subsystem and requires factory service. Consult the factory for further information.

---

**Interlock Open Fault  
External Interlock**

The external interlock is open, forcing the **EMCPro PLUS** into a safe state.

If a cable is in the interlock connector, remove it and check that the fault goes away. Repair any break in the external interlock circuit.

**Mains Fault: Disconnect and check EUT  
If fault recurs contact Thermo Service**

During a PQF test a high-current was detected, possibly due to a short in the EUT.

Disconnect the EUT and check it for possible shorts line-to-line or line-to-chassis. Retest. Test with a second EUT if possible.

If this message persists factory service is required. Consult Customer Service for detail.

**Stop Test Input Active  
Reset this Input before continuing test**

A short to ground was detected on the front panel coax, STOP TEST. Remove the short and press the EXIT button beneath the display to clear the message.

**Tilt Switch Fault  
Unit must be horizontal for test**

The **EMCPro PLUS** is orientation-sensitive and will only perform Surge and EFT testing in a horizontal position. Restore the **EMCPro PLUS** to a horizontal position and press the EXIT button beneath the display to clear the message.

**EUT Overload Fault  
Allow Time for breaker to Reset**

The **EMCPro PLUS** detected an overcurrent condition on the EUT mains output, removed mains power, and displayed this message. Press the EXIT button beneath the display to clear the message. The overcurrent detector within the **EMCPro PLUS** will reset automatically, but may take several minutes to reset. During this time you can perform other testing, but will be unable to switch the EUT power on.



---

**Timeout on Remote Control: check PC application and connection**

The **EMCPro PLUS**, while running under control of a PC, lost communications with the PC. For safety, a loss of communications halts all tests. Check connections between the PC and the **EMCPro PLUS**, and check that the PC application is running.

**Unspecified Fault  
#<fault number>**

Record the fault number and retry the failed test. If this fault persists, report it to Customer Service.

**Filing a Problem Report**

When reporting a problem to Thermo Customer Service, please include the serial number and model number from the rear panel of the **EMCPro PLUS** (and serial number of the ESD probe or other accessories, if applicable).

If your **EMCPro PLUS** is operational, access the SYSTEM menu, VERSIONS screen and copy all the information shown to include in your trouble report.

```
| VERSIONS          |||||||||EUT OFF|
Firmware           ..... Vx.xx
Kernel             ..... Vx.xx
String Database    .... Vx.xx
Option Code        .... AA
Serial Number
||      ||      ||      ||      ||      ||      ||EXIT
```

The Version Menu shows a Build date and time, five arguments with revisions, and a code indicating the installed options.

Mail, Fax, or Phone your problem report to:

**Customer Service, Compliance Testing**  
**Thermo Electron Corporation**  
One Lowell Research Center  
Lowell, MA 01852-4345 USA

Voice: 978-275-0800 FAX: 978-275-0850  
E-mail: sales.esd@thermo.com

or your local, authorized service representative.

---

# Appendix A

## Multi-Contact Accessories

The EMCPPro and EMCPPro PLUS both use 4mm safety jacks from Multi-Contact. To obtain parts please refer to the Multi-Contact electronic catalog at

**MC USA**  
**U.S Headquarters**  
**5560 Skylane Blvd.**  
**Santa Rosa, CA 95403**  
<http://www.multi-contact-usa.com>

---

### **WEEE Compliance:**

This product is required to comply with the European Union's Waste Electrical and Electronic Equipment (WEEE) Directive 2002/96/EC. It is marked with the following symbol:



Thermo Electron has contracted with one or more recycling/disposal companies in each EU Member State, and this product should be disposed of or recycled through them. Further information on Thermo Electron's compliance with these Directives, the recyclers in your country, and information on Thermo Electron products which may assist the detection of substances subject to the RoHS Directive are available at [\*\*www.thermo.com/WEEERoHS\*\*](http://www.thermo.com/WEEERoHS)