



WYS SERIES SPLIT 3D DC INVERTER HEAT PUMP / AIR CONDITIONER SERVICE MANUAL

Model Numbers:

17 SEER Family: WYS009AMFI17RL, WYS012AMFI17RL, WYS009GMFI17RL, WYS012GMFI17RL,
WYS018GMFI17RL, WYS024GMFI17RL, WYS030GMFI17RL, WYS036GMFI17RL

22 SEER Family: WYS009AMFI22RL, WYS012AMFI22RL, WYS009GMFI22RL, WYS012GMFI22RL,
WYS018GMFI22RL, WYS024GMFI22RL

Table of Contents

1. Precaution
2. Part Names And Functions
3. Dimension
4. Refrigerant Cycle Diagram
5. Wiring Diagram
6. Installation Details
7. Operation Characteristics
8. Electronic Function
9. Troubleshooting
10. Disassembly Instructions



Energy Star Applies to
Only 22 SEER MODELS

WARNING

- Installation MUST conform with local building codes or, in the absence of local codes, with the National Electrical Code NFPA70/ANSI C1-1993 or current edition and Canadian Electrical Code Part1 CSA C.22.1.
- The information contained in the manual is intended for use by a qualified service technician familiar with safety procedures and equipped with the proper tools and test instruments
- Installation or repairs made by unqualified persons can result in hazards to you and others.
- Failure to carefully read and follow all instructions in this manual can result in equipment malfunction, property damage, personal injury and/or death.
- This service manual is only for service engineer's use.

CONTENTS

1. Precaution	1
1.1 Safety Precaution	1
1.2 Warning	1
2. Part Names And Functions	4
2.1 Model Names of Indoor/Outdoor units	4
2.2 Part names of Indoor/Outdoor units	5
3. Dimension	6
3.1 Indoor Unit	6
3.2 Outdoor Unit	8
4. Refrigerant Cycle Diagram	10
5. Wiring Diagram	12
6 Installation Details	12
6.1 Wrench torque sheet for installation	12
6.2 Connecting the cables	12
6.3 Pipe length and the elevation	12
6.4 Installation for the first time	13
6.5 Adding the refrigerant after running the system for many years	13
6.6 Re-installation while the indoor unit need to be repaired	14
6.7 Re-installation while the outdoor unit need to be repaired	14
7. Operation Characteristics	17
8. Electronic Function	18
8.1 Abbreviation	18
8.2 Display function	18
8.3 Main Protection	18
8.4 Operation Modes and Functions	19
9. Troubleshooting	26
9.1 Indoor Unit Error Display	27
9.2 Outdoor unit error display(TBD)	29
9.3 Diagnosis and Solution	35
10 Disassembly Instructions	64
10.1 Indoor unit	64
10.2 Outdoor unit	68

1. Precaution

1.1 Safety Precaution

- To prevent injury to the user or other people and property damage, the following instructions must be followed.

- Incorrect operation due to ignoring instructions will cause harm or damage.
- Before servicing the unit, be sure to read this service manual at first.

1.2 Warning

➤ Installation

- Do not use a defective or underrated circuit breaker. Use this appliance on a dedicated circuit.

There is risk of fire or electric shock.

- For electrical work, contact the dealer, seller, a qualified electrician, or an authorized service center.

Do not disassemble or repair the product, there is risk of fire or electric shock.

- Always ground the product.

There is risk of fire or electric shock.

- Install the panel and the cover of control box securely.

There is risk of fire of electric shock.

- Always install a dedicated circuit and breaker.

Improper wiring or installation may cause electric shock.

- Use the correctly rated breaker or fuse.

There is risk of fire or electric shock.

- Do not modify or extend the power cable.

There is risk of fire or electric shock.

- Do not install, remove, or reinstall the unit by any untrained persons.

There is risk of fire, electric shock, explosion, or injury.

- Use caution when unpacking and installing the product.

Sharp edges could cause injury, be

especially careful of the case edges and the fins on the condenser and evaporator.

- For installation, always contact the dealer or an authorized service center.

- Do not install the product on a defective installation stand.

- Be sure the installation area does not deteriorate with age.

If the base collapses, the air conditioner could fall with it, causing property damage, product failure, and personal injury.

- Do not let the air conditioner run for a long time when the humidity is very high and a door or a window is left open.

- Take care to ensure that power cable could not be pulled out or damaged during operation.

There is risk of fire or electric shock.

- Do not place anything on the power cable.

There is risk of fire or electric shock.

- Do not plug or unplug the power supply plug during operation.

There is risk of fire or electric shock.

- Do not touch the operating the product with wet hands.

- Do not place a heater or other appliance near the power cable.

There is risk of fire and electric shock.

- Do not allow water to run into electrical parts.

It may cause fire, failure of the product, or electric shock.

- Do not store or use flammable gas or combustible near the product.

There is risk of fire or failure of product.

- Do not use the product in a tightly closed space for a long time.

Oxygen deficiency could occur.

- When flammable gas leaks, turn off the gas and open a window for ventilation before turn the product on.

- If strange sounds or smoke comes from product, turn the breaker off or disconnect the power supply cable.

There is risk of electric shock or fire.

- **Stop operation and close the window in storm or hurricane. If possible, remove the product from the window before the hurricane arrives.**

There is risk of property damage, failure of product, or electric shock.

- **Do not open the inlet grill of the product during operation. (Do not touch the electrostatic filter, if the unit is so equipped.)**

There is risk of physical injury, electric shock, or product failure.

- **When the product is soaked, contact an authorized service center.**

There is risk of fire or electric shock.

- **Use caution that water should not enter the product.**

There is risk of fire, electric shock, or product damage.

- **Ventilate the product from time to time when operating it together with a stove etc.**

There is risk of fire or electric shock.

- **Turn the main power off when cleaning or maintaining the product.**

There is risk of electric shock.

- **When the product is not be used for a long time, disconnect the power supply and turn off the breaker.**

There is risk of product damage or failure, or unintended operation.

- **Take care to ensure that nobody could step on or fall onto the outdoor unit.**

This could result in personal injury and product damage.

➤ **CAUTION**

- **Always check for gas (refrigerant) leakage after installation or repair of product.**

Low refrigerant levels may cause failure of product.

- **Install the drain hose to ensure that water is drained away properly.**

A bad connection may cause water leakage.

- **Keep level even when installing the**

product.

It can avoid vibration of water leakage.

- **Do not install the product where the noise or hot air from the outdoor unit could disturb the neighborhoods.**

It may cause a problem for your neighbors.

- **Use two or more people to lift and transport the product.**

- **Do not install the product where it will be exposed to sea wind (salt spray) directly.**

It may cause corrosion on the product.

Corrosion, particularly on the condenser and evaporator fins, could cause product malfunction or inefficient operation.

➤ **Operational**

- **Do not expose the skin directly to cool air for long time. (Do not sit in the draft).**

- **Do not use the product for special purposes, such as preserving food, works of art etc. It is a comfort air conditioner, not a precision refrigeration system.**

There is risk of damage or loss of property.

- **Do not block the inlet or outlet of air flow.**

- **Use a soft cloth to clean. Do not use harsh detergents, solvents, etc.**

There is risk of fire, electric shock, or damage to the plastic parts of the product.

- **Do not touch the metal parts of the product when removing the air filter. They are very sharp.**

- **Do not step on or put anything on the product. (outdoor units)**

- **Always insert the filter securely. Clean the filter every two weeks or more often if necessary.**

A dirty filter reduces the efficiency of the air conditioner and could cause product malfunction or damage.

- **Do not insert hands or other objects through air inlet or outlet while the product is operated.**

- **Do not drink the water drained from**

the product.

■ **Use a firm stool or ladder when cleaning or maintaining the product.**

Be careful and avoid personal injury.

■ **Replace the all batteries in the remote control with new ones of the same type. Do not mix old and new batteries or different types of batteries.**

There is risk of fire or explosion.

■ **Do not recharge or disassemble the batteries. Do not dispose of batteries in a fire.**

They may burn or explode.

■ **If the liquid from the batteries gets onto your skin or clothes, wash it well with clean water. Do not use the remote if the batteries have leaked.**

2. Part Names And Functions

2.1 Model Names of Indoor / Outdoor units

Capacity	Voltage	Indoor units	Outdoor units
9k	115V	WS009AMFI17HLD	YN009AMFI17RPD
12k	115V	WS012AMFI17HLD	YN012AMFI17RPD
9k	208-230V	WS00GAMFI17HLD	YN009GMFI17RPD
12k	208-230V	WS012GMFI17HLD	YN012GMFI17RPD
18k	208-230V	WS018GMFI17HLD	YN018GMFI17RPD
24k	208-230V	WS024GMFI17HLD	YN024GMFI17RPD
30k	208-230V	WS030GMFI17HLD	YN030GMFI17RPD
36k	208-230V	WS036GMFI17HLD	YN036GMFI17RPD
9k	115V	WS009AMFI22HLD	YN009AMFI22RPD
12k	115V	WS012AMFI22HLD	YN012AMFI22RPD
9k	208-230V	WS00GAMFI22HLD	YN009GMFI22RPD
12k	208-230V	WS012GMFI22HLD	YN012GMFI22RPD
18k	208-230V	WS018GMFI22HLD	YN018GMFI22RPD
24k	208-230V	WS024GMFI22HLD	YN024GMFI22RPD

2.2 Part names of Indoor/Outdoor units

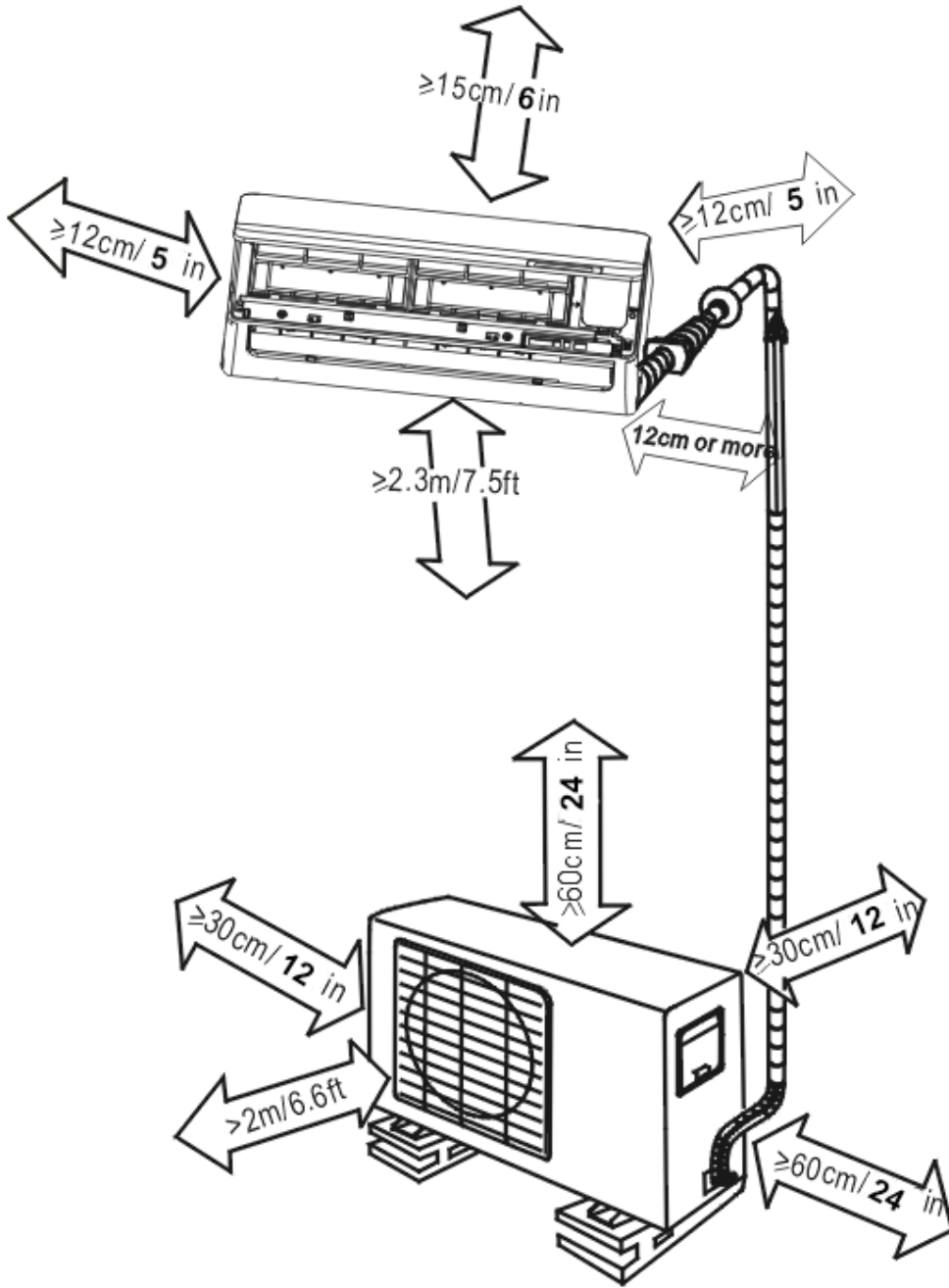

3. Dimension

3.1 Indoor Unit

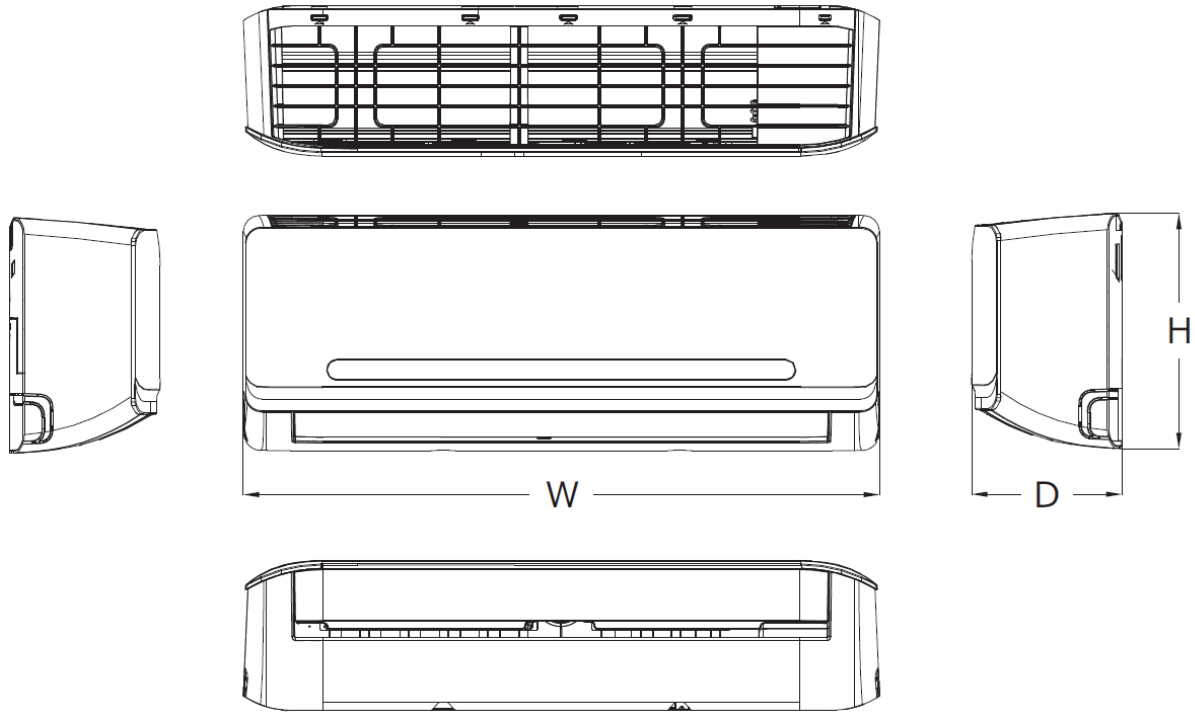

Indoor Unit Model	WxDxH (mm)	WxDxH (inch)	Mounting plate
WS009AMFI17HLD WS009GMFI17HLD	722 x 187 x 290	28-3/8 x 7-3/8 x 11-3/8	A
WS012AMFI17HLD WS012GMFI17HLD WS009AMFI22HLD WS009GMFI22HLD WS012AMFI22HLD WS012GMFI22HLD	802 x 189 x 297	31-1/2 x 7-3/8 x 11-5/8	B
WS018GMFI17HLD	965 x 215 x 319	38 x 8-3/8 x 12-1/2	C
WS024GMFI17HLD WS018GMFI22HLD WS024GMFI22HLD	1080 x 226 x 335	42-1/2 x 8-7/8 x 13-1/4	D
WS030GMFI17HLD WS036GMFI17HLD	1259 x 282 x 362	49-1/2 x 11-1/8 x 14-1/4	E

For Mounted plate A,

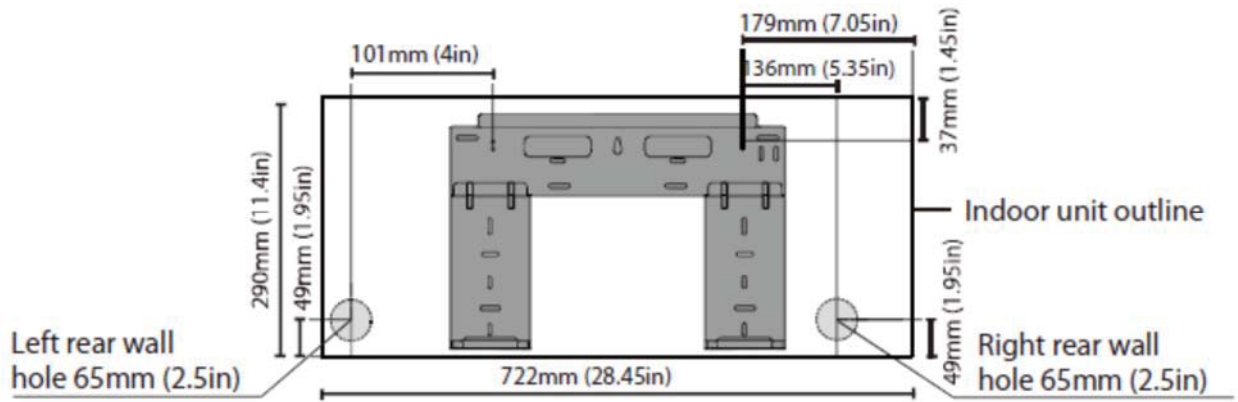

For Mounted plate B,

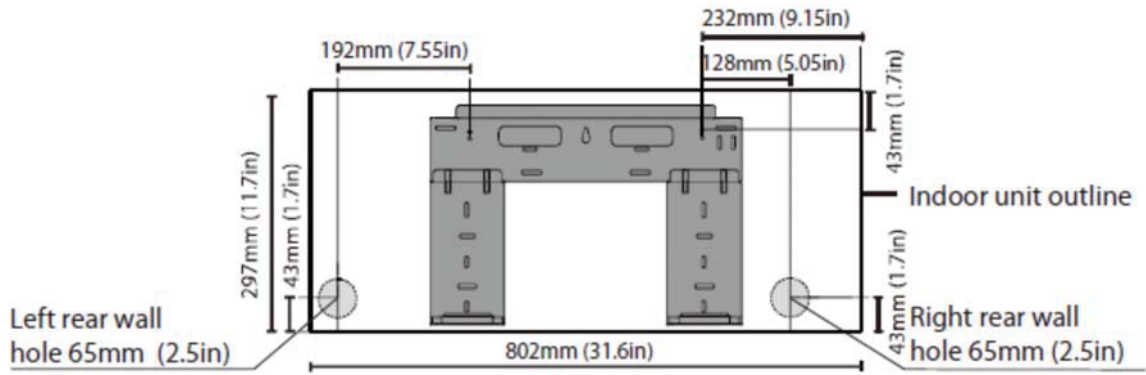

For Mounted plate C,

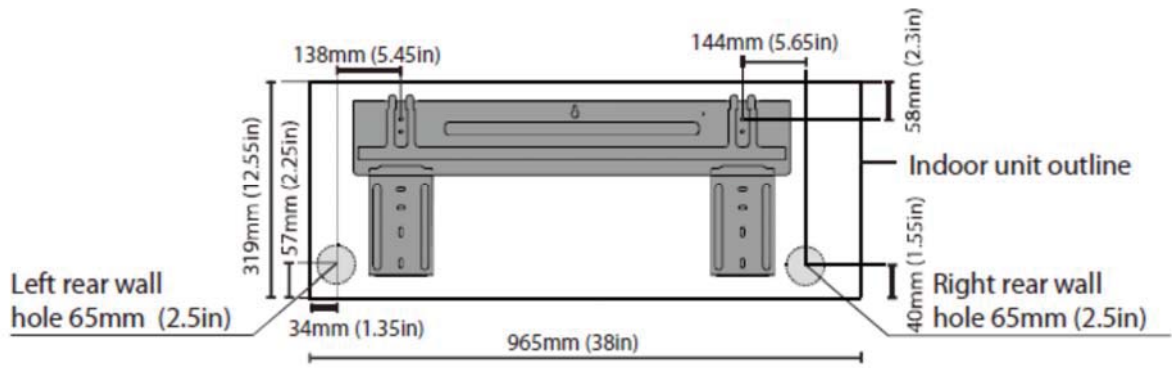

For Mounted plate D,

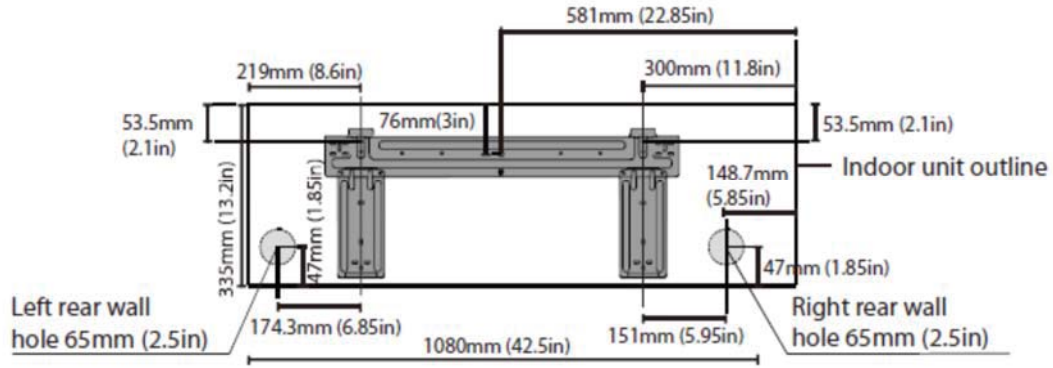

For Mounted plate E,

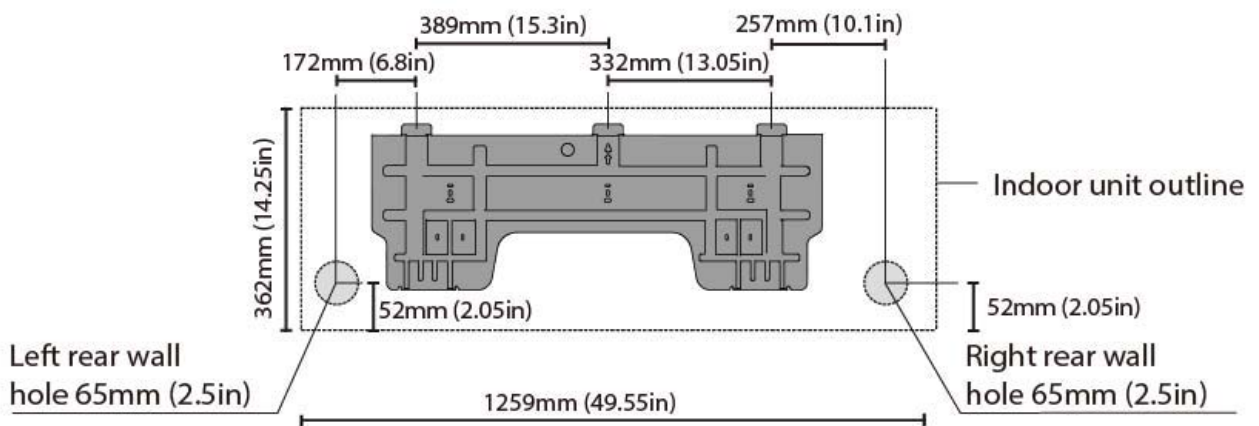

3.2 Outdoor Unit

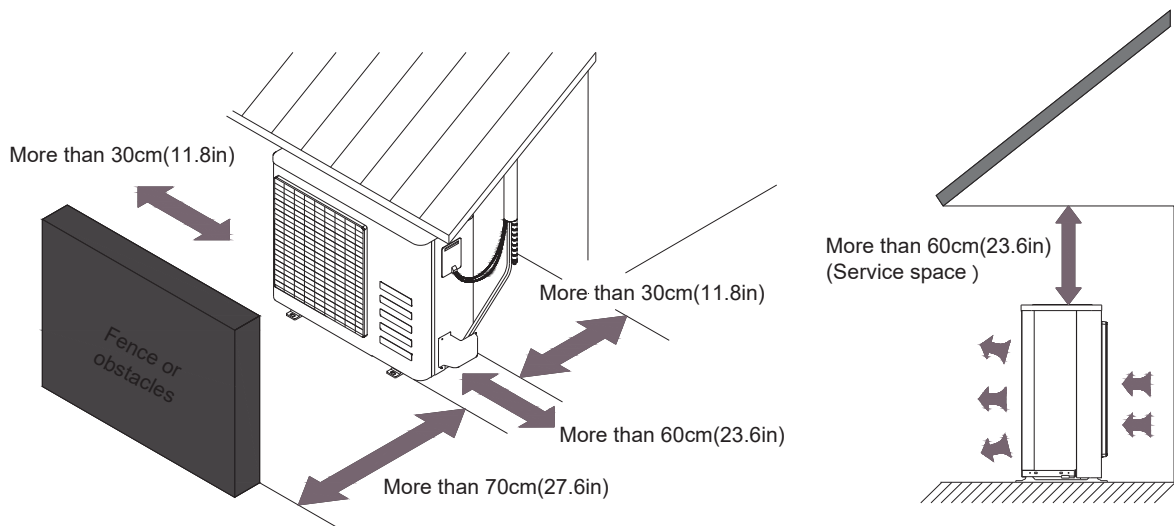

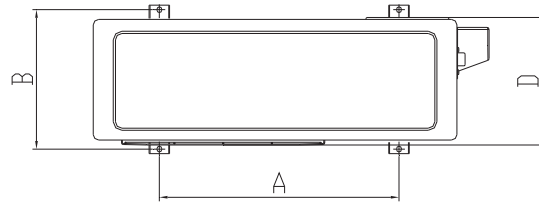
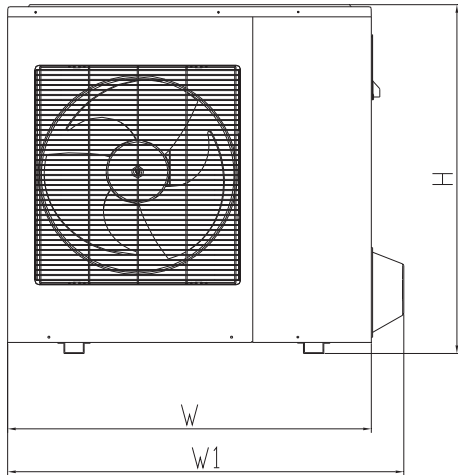

Note: The above drawing is only for reference. The appearance of your units may be different.

Outdoor Unit Model	W	D	H	W1	A	B
YN009AMFI17RPD YN009GMFI17RPD YN012AMFI17RPD YN012GMFI17RPD	770 (mm)	300 (mm)	555 (mm)	840 (mm)	487 (mm)	298 (mm)
YN009AMFI22RPD YN009GMFI22RPD	30-1/4 (inch)	11-3/4 (inch)	21-3/4 (inch)	33-1/8 (inch)	19-1/4 (inch)	11-3/4 (inch)
YN018GMFI17RPD YN012AMFI22RPD YN012GMFI22RPD	800 (mm) 31-1/2 (inch)	333 (mm) 13-1/8 (inch)	554 (mm) 21-3/4 (inch)	870 (mm) 34-1/4 (inch)	514 (mm) 20-1/4 (inch)	340 (mm) 13-3/8 (inch)
YN018GMFI22RPD	845 (mm) 33-1/4 (inch)	363 (mm) 14-1/4 (inch)	702 (mm) 27-5/8 (inch)	914 (mm) 36 (inch)	540 (mm) 21-1/4 (inch)	350 (mm) 13-3/8 (inch)
YN030GMFI17RPD YN030GMFI17RPD YN024GMFI22RPD	946 (mm) 37-1/4 (inch)	410 (mm) 16-1/8 (inch)	810 (mm) 31-7/8 (inch)	1030 (mm) 40-1/2 (inch)	673 (mm) 26-1/2 (inch)	403 (mm) 15-7/8 (inch)

4. Refrigerant Cycle Diagram

WYS009AMFI17RL, WYS012AMFI17RL, WYS009GMFI17RL, WYS012GMFI17RL,
 WYS018GMFI17RL, WYS024GMFI17RL, **WYS009AMFI22RL, WYS012AMFI22RL**

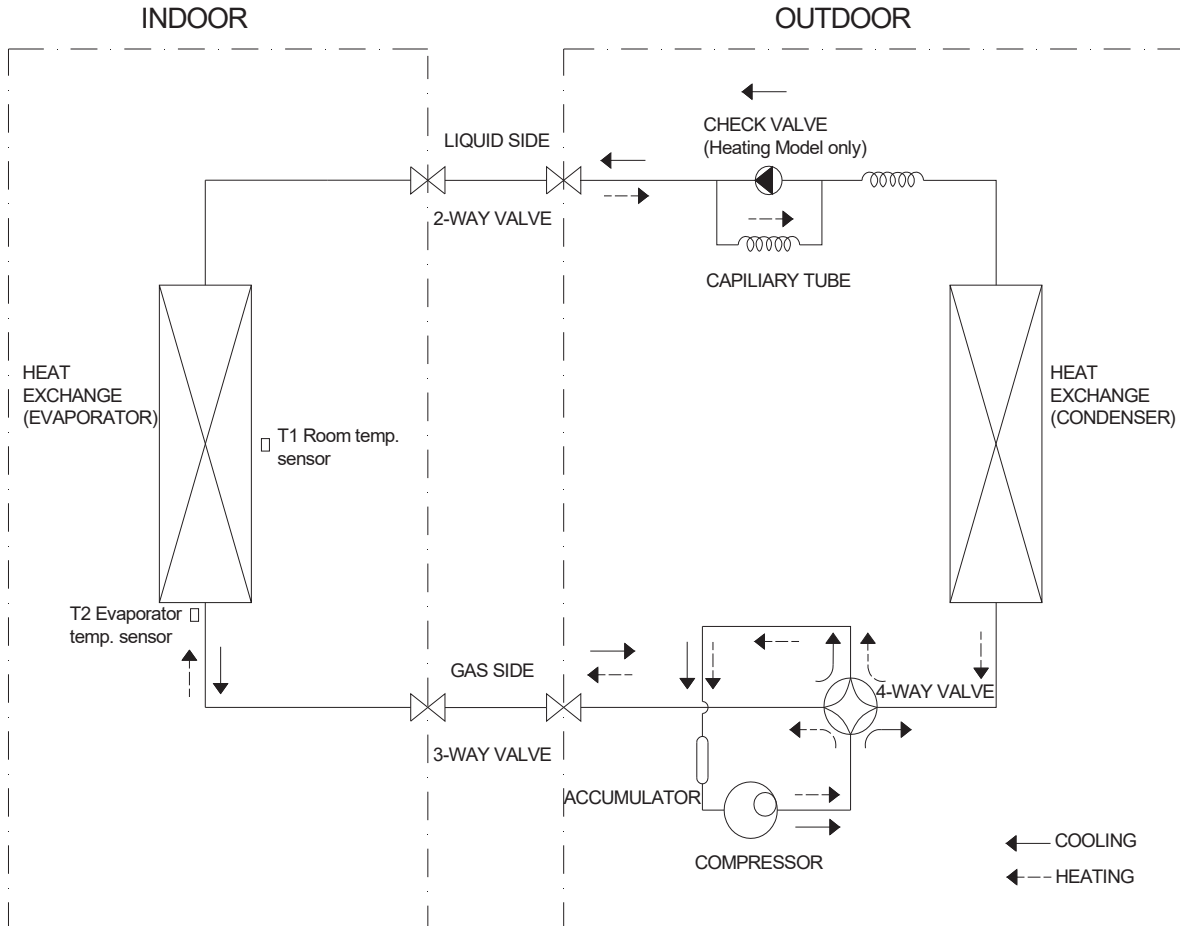

**WYS009GMFI22RL, WYS012GMFI22RL, WYS018GMFI22RL, WYS024GMFI22RL,
WYS030GMFI17RL, WYS036GMFI17RL**

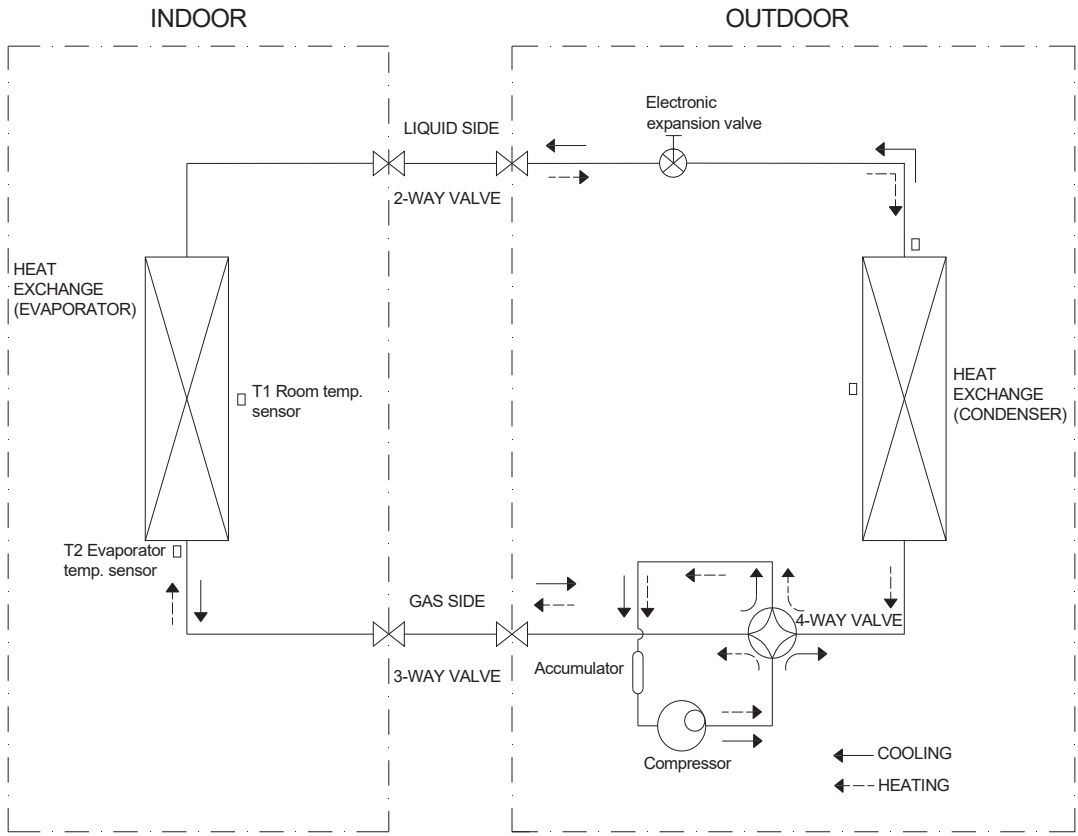

5. Wiring Diagram

(Pls refer the wiring diagram on the unit)

6 Installation Details

6.1 Wrench torque sheet for installation

Outside diameter		Torque	Additional tightening torque
Φ6.35mm	1/4in	1500N.cm(153kgf.cm)	1600N.cm(163kgf.cm)
Φ9.52mm	3/8in	2500N.cm(255kgf.cm)	2600N.cm(265kgf.cm)
Φ12.7mm	1/2in	3500N.cm(357kgf.cm)	3600N.cm(367kgf.cm)
Φ15.9mm	5/8in	4500N.cm(459kgf.cm)	4700N.cm(479kgf.cm)
Φ19mm	3/4in	6500N.cm(663kgf.cm)	6700N.cm(683kgf.cm)

6.2 Connecting the cables

The power cord should be selected according to the following specifications sheet.

Appliance Amps	AWG Wire Size
10	18
13	16
18	14
25	12
30	10

The cable size and the current of the fuse or switch are determined by the maximum current indicated on the nameplate which located on the side panel of the unit. Please refer to the nameplate before selecting the cable, fuse and switch.

6.3 Pipe length and the elevation

Models	Pipe size	
	Gas	Liquid
9K	3/8in (Φ9.52mm)	1/4in (Φ6.35mm)
12K, 18K	1/2in (Φ12.7mm)	1/4in (Φ6.35mm)
24K, 30K, 36K	5/8in (Φ15.9mm)	3/8in (Φ9.52mm)

Models	Standard length (pre-charged)	Max. Elevation	Max. Length A	Additional Refrigerant
9K, 12K	7.5m (25 ft)	10m (33 ft)	25m (82 ft)	15g/m (0.16 oz/ft)
18K	7.5m (25 ft)	20m (66 ft)	30m (100 ft)	15g/m (0.16 oz/ft)
24K	7.5m (25 ft)	25m (82 ft)	50m (164 ft)	30g/m (0.32 oz/ft)
30K	7.5m (25 ft)	25m (82 ft)	50m (164 ft)	30g/m (0.32 oz/ft)
36K	7.5m (25 ft)	30m (82 ft)	65m (213 ft)	30g/m (0.32 oz/ft)

6.4 Installation for the first time

Air and moisture in the refrigeration system will cause undesirable effects as below:

- Pressure in the system rises.
- Operating current rises.
- Cooling or heating efficiency drops.
- Moisture in the refrigerant circuit may freeze and block capillary tubing.
- Water may lead to corrosion of parts in the refrigeration system.

Therefore, the indoor units and the pipes between indoor and outdoor units must be leak tested and evacuated to remove the air and moisture from the system.

Gas leak check (Soap water method):

After pressurizing the system, apply soap water or a liquid neutral detergent on the indoor unit connections or outdoor unit connections by a soft brush to check for leakage of the connection points of the piping. If bubbles come out, the pipes have leakage.

1. Air purging with vacuum pump

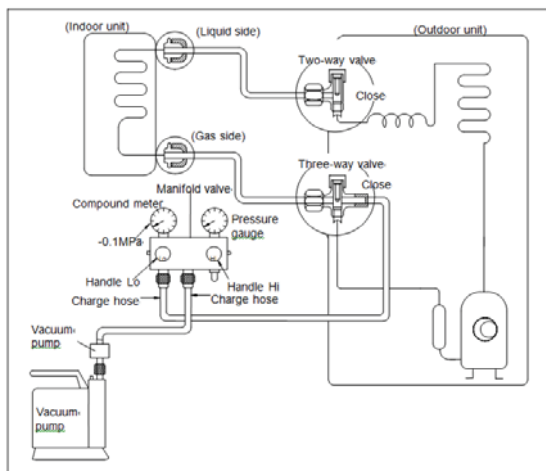

- 1) Completely tighten the flare nuts of the indoor and outdoor units, confirm that both the 2-way and 3-way service valves are set to the closed position.
- 2) Connect the charging manifold's low side hose to the 3-way valve's gas service port.
- 3) Connect the charging manifold's middle hose to the vacuum pump.
- 4) Fully open the Low Side of the manifold valve.
- 5) Operate the vacuum pump to evacuate.

- 6) Make evacuation for 30 minutes and check whether the compound meter indicates Minus 0.1 MPa (-14.5 PSI) or 500 Microns. If the meter does not indicate -0.1Mpa (-14.5Psi) after pumping 30 minutes, it should be pumped 20 minutes more. If the pressure can't achieve -0.1Mpa (-14.5Psi) after pumping 50 minutes, please check if there are some leakage points. Fully close the Low side valve of the manifold and stop the operation of the vacuum pump. Confirm that the gauge needle does not move higher (approximately 5 minutes after turning off the vacuum pump).
- 7) Turn the core valve of the 3-way valve about 45° counterclockwise for 6 or 7 seconds while observing sound of gas filling the pipes, then tighten the valve core again. Make sure the pressure display in the pressure indicator is a little higher than the atmospheric pressure. Then remove the charge hose from the 3 way valve. Check for leaks.
- 8) Fully open the 2 way valve and 3 way valve and securely tighten the dust cap of the 3 way valve service port. Check for leaks.

6.5 Adding the refrigerant after running the system for many years

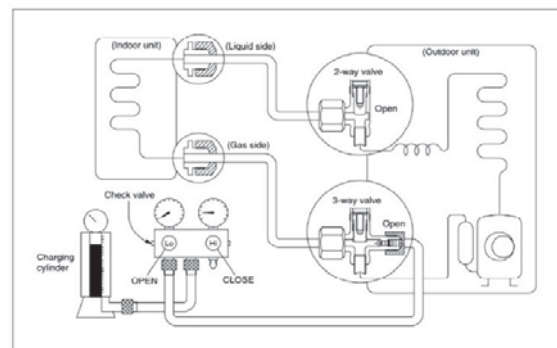

Procedure

- 1) Connect the charge hose to the 3-way service port, open the 2-way valve and the 3-way valve.
Connect the charge hose to the valve at the bottom of the cylinder. If the refrigerant is R410A, make the cylinder bottom up to ensure liquid charge.
- 2) Purge the air from the charging hoses.

Open the valve at the bottom of the cylinder and press the check valve on the charge set to purge the air (be careful with the liquid refrigerant).

3) Put the charging cylinder onto the electronic scale and record the weight.

4) Operate the air conditioner at the cooling mode.

5) Open the valves (Low side) on the charge set and charge the system with liquid refrigerant.

6).When the electronic scale displays the proper weight (refer to the gauge and the pressure of the low side), disconnect the charge hose from the 3-way valve's service port immediately and turn off the air conditioner before disconnecting the hose.

7). Mount the valve stem caps and the service port

Use torque wrench to tighten the service port cap to a torque of 18N.m.

Be sure to check for gas leakage.

6.6 Re-installation while the indoor unit need to be repaired

1. Collecting the refrigerant into the outdoor unit

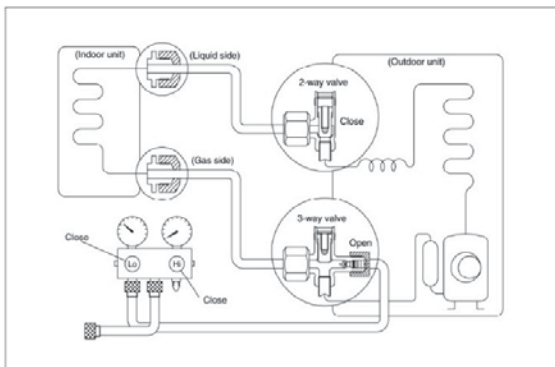

Procedure

- 1). Confirm that both the 2-way and 3-way valves are set to the opened position. Remove the valve stem caps and confirm that the valve stems are in the opened position. Be sure to use a hexagonal wrench to operate the valve stems.
- 2). Connect the low side hose of the manifold set the 3-way valves gas service port.

3). Purge the air off the charging hose.

Open the handle Low side valve of the manifold valve slightly to purge air from the charge hose for 5 seconds and then close it quickly.

4). Set the 2-way valve to the closed position.

5). Operate the air conditioner at the cooling cycle and stop it when the gauge indicates 0.1Mpa(14.5Psi).

6). Set the 3-way valve to the closed position immediately

Do this quickly so that the gauge ends up indicating 0.3Mpa(43.5Psi) to 0.5 Mpa(72.5Psi).

Disconnect the charge set, and tighten the 2-way and 3-way valve's stem nuts.

Use a torque wrench to tighten the 3-way valves service port cap to a torque of 18N.m.

Be sure to check for gas leakage.

2. Air purging with vacuum pump

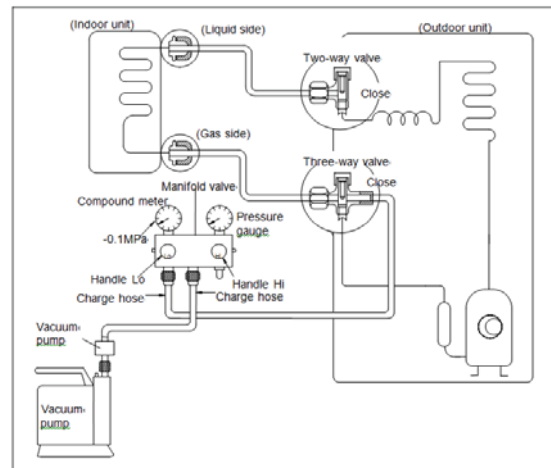

1) Completely tighten the flare nuts of the indoor and outdoor units, confirm that both the 2-way and 3-way valves are set to the closed position.

2) Connect the low side charging hose of the manifold to the 3-way valve's gas service port.

3) Connect the middle hose of the manifold set to the vacuum pump.

4) Fully open the low side valve of the manifold.

5) Operate the vacuum pump to evacuate.

6) Make evacuation for 30 minutes and check whether the compound meter indicates Minus 0.1Mpa(-14.5Psi). If the meter does not indicate -0.1Mpa(-14.5Psi) after pumping 30 minutes, it should be pumped 20 minutes more. If the

pressure can't achieve -0.1Mpa (14.5Psi) after pumping 50 minutes, please check if there are some leakage points. Fully close the low side of the manifold and stop the operation of the vacuum pump. Confirm that the gauge needle does not move up (approximately 5 minutes after turning off the vacuum pump).

9) Turn the core valve of the 3-way valve about 45° counterclockwise for 6 or 7 seconds while observing sound of gas filling the pipes, then tighten the valve core again. Make sure the pressure display in the pressure indicator is a little higher than the atmospheric pressure. Then remove the charge hose from the 3 way valve. Check for leaks.

10) Fully open the 2 way valve and 3 way valve and securely tighten the dust cap of the 3 way valve service port. Check for leaks.

6.7 Re-installation while the outdoor unit need to be repaired

1. Evacuation for the whole system

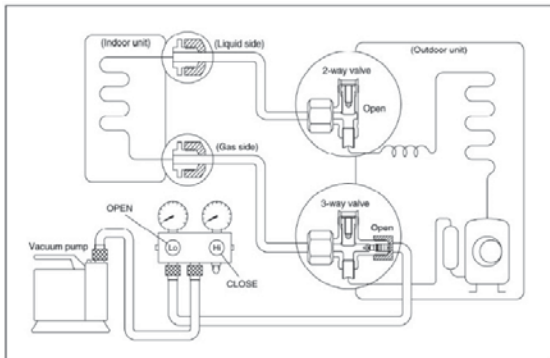

Procedure:

- 1). Confirm that both the 2-way and 3-way valves are set to the opened position.
- 2). Connect the vacuum pump to 3-way valve's service port.
- 3). Evacuate for approximately one hour. Confirm that the compound meter indicates – minus 0.1Mpa (14.5Psi).
- 4). Close the valve (Low side) on the charge set, turn off the vacuum pump, and confirm that the gauge needle does not move up (approximately 5 minutes after turning off the vacuum pump).
- 5). Disconnect the charge hose from the

vacuum pump.

2. Refrigerant charging

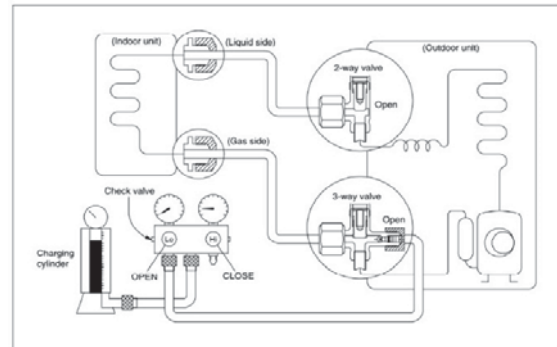

Procedure:

- 1). Connect the charge hose to the charging cylinder, open the 2-way valve and the 3-way valve

Connect the charge hose which you disconnected from the vacuum pump to the valve at the bottom of the cylinder. If the refrigerant is R410A, make the cylinder bottom up to ensure liquid charge.

- 2). Purge the air from the charge hose
Open the valve at the bottom of the cylinder and press the check valve on the charge set to purge the air (be careful with the liquid refrigerant).
- 3) Put the charging cylinder onto the electronic scale and record the weight.
- 4). Open the valves (Low side) on the charge set and charge the system with liquid refrigerant

If the system cannot be charged with the specified amount of refrigerant, or can be charged with a little at a time (approximately 150g each time) , operate the air conditioner in the cooling cycle; however, one time is not sufficient, wait approximately 1 minute and then repeat the procedure.

- 5).When the electronic scale displays the proper weight, disconnect the charge hose from the 3-way valve's service port immediately
If the system has been charged with liquid refrigerant while operating the air conditioner, turn off the air conditioner before disconnecting the hose.

6). Mount the valve stem caps and the service port. Use torque wrench to tighten the service port cap to a torque of 18N.m. Be sure to check for gas leakage.

7. Operation Characteristics

Temperature Mode	Cooling operation	Heating operation	Drying operation
Room temperature	17°C ~ 32°C (62°F ~ 90°F)	0°C ~ 30°C (32°F ~ 86°F)	10°C ~ 32°C (50°F ~ 90°F)
Outdoor temperature WYS009AMFI17RL, WYS012AMFI17RL, WYS009GMFI17RL, WYS012GMFI17RL, WYS018GMFI17RL, WYS024GMFI17RL	0°C ~ 50°C (32°F ~ 122°F)	-15°C ~ 30°C (5°F ~ 86°F)	0°C ~ 50°C (32°F ~ 122°F)
	-15°C ~ 50°C (5°F ~ 122°F)		
Outdoor temperature WYS030GMFI17RL, WYS036GMFI17RL, WYS009AMFI22RL, WYS012AMFI22RL WYS009GMFI22RL, WYS012GMFI22RL WYS018GMFI22RL, WYS024GMFI22RL	-25°C ~ 50°C (-13°F ~ 122°F)	-25°C ~ 50°C (-13°F ~ 122°F)	0°C ~ 50°C (32°F ~ 122°F)

$$\Delta T(^{\circ}\text{F}) = \frac{9\Delta T(^{\circ}\text{C})}{5} + 32$$

CAUTION:

1. If the air conditioner is used beyond the above conditions, certain safety protection features may come into operation and cause the unit to operate abnormally.
2. The room relative humidity should be less than 80%. If the air conditioner operates beyond this figure, the surface of the air conditioner may attract condensation. Please set the vertical air flow louver to its maximum angle (vertically to the floor), and set HIGH fan mode.
3. The optimum performance will be achieved during this operating temperature zone.

8. Electronic Function

8.1 Abbreviation

- T1: Indoor room temperature
- T2: Coil temperature of evaporator
- T3: Coil temperature of condenser
- T4: Outdoor ambient temperature
- TP: Compressor discharge temperature

8.2 Display function

8.2.1 Icon explanation on indoor display board.



Digital display:

Displays the temperature settings when the air conditioner is operational.

Displays the room temperature in FAN mode.

Displays the self-diagnostic codes.

Displays 'ON' for three seconds when Timer ON, Fresh, Swing, Turbo or Silence feature is activated.

Displays 'OF' for three seconds when Fresh, Swing, Turbo or Silence feature is cancelled.

Displays 'DF' under defrosting operation.

Displays 'cF' when anti-cold air feature is activated under heating mode.

Displays 'SC' during self clean operation (if applicable).

Displays 'FP' under 8°C heating operation (if applicable).

When ECO function(optional) is activated, the "88" illuminates gradually one by one as E → C → 0 → set temperature → E In one second interval.

NOTE:

A guide on using the infrared remote is not included in this literature package.

8.3 Main Protection

8.3.1 Three minutes delay at restart for

compressor

1 minute delay for the 1st time stand-up and 3 minutes delay for others.

8.3.2 Temperature protection of compressor top

The unit will stop working when the compressor top temp. protector cut off, and will restart after the compressor top temp. protector restart.

8.3.3 Temperature protection of compressor discharge

Compressor discharge temp. $TP > 115^{\circ}\text{C}$ for 5s, compressor stops.

8.3.4 Fan speed is out of control

When indoor fan speed keeps too low (300RPM) for certain time, the unit will stop and the LED will display the failure

8.3.5 Inverter module protection

The Inverter module has a protection function about current, voltage and temperature. If these protections happen, the corresponding code will display on indoor unit and the unit will stop working.

8.3.6 Indoor fan delayed open function

When the unit starts up, the louver will be active immediately and the indoor fan will open 7s later. If the unit runs in heating mode, the indoor fan will be also controlled by anti-cold wind function.

8.3.7 Compressor preheating functions

Preheating permitting condition:

When $T_4(\text{outdoor ambient temperature}) < 3^{\circ}\text{C}$, the preheating function will be activated.

8.3.8 Sensor protection at open circuit and breaking disconnection.

When there's only one temperature sensor in malfunction, the air conditioner will keep working but show the error code, in case of any emergency use.

When there's more than one temperature sensor in malfunction, the air conditioner will stop working.

8.4 Operation Modes and Functions

8.4.1 Fan mode

- (1) Outdoor fan and compressor stop.
- (2) Temperature setting function is disabled, and no setting temperature is displayed.

(3) Indoor fan can be set to high/med/low/auto.

(4) The louver operates same as in cooling mode.

(5) Auto fan:

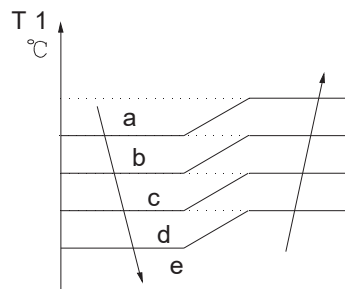

8.4.2 Cooling Mode

8.4.2.1 Compressor running rules

When $T_1 - T_s < \Delta T - 2^{\circ}\text{C}$, the compressor will stop, when $T_1 - T_s > \Delta T - 0.5^{\circ}\text{C}$, the compressor will be activated.

ΔT is the programmed parameter of temperature compensation.

When the AC run in mute mode, the compressor will run with low frequency.

When the current is more than setting value, the current protection function will be activated, and the compressor will stop.

8.4.2.2 Outdoor fan running rules

The outdoor unit will be run at different fan speed according to T_4 .

For different outdoor units, the fan speeds are different.

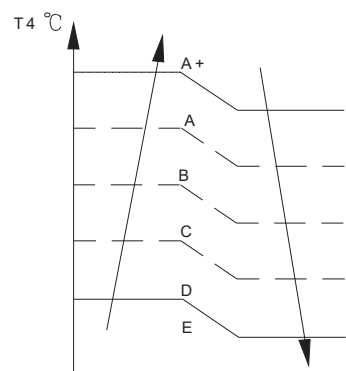

8.4.2.3 Indoor fan running rules

In cooling mode, indoor fan runs all the time and the speed can be selected as high, medium, low

and auto.

The indoor fan is controlled as below:

Setting fan speed	T1-Td °C(°F)	Actual fan speed
H	A	H+ (H+=H+G)
	B	H (=H)
	C	H- (H-=H-G)
M	D	M+ (M+=M+Z)
	E	M (M=M)
	F	M- (M-=M-Z)
L	G	L+ (L+=L+D)
	H	L (L=L)
	I	L- (L-=L-D)

The auto fan acts as below rules:

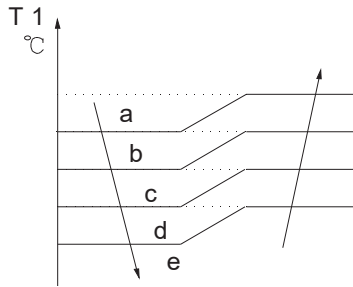

8.4.2.4 Condenser temperature protection

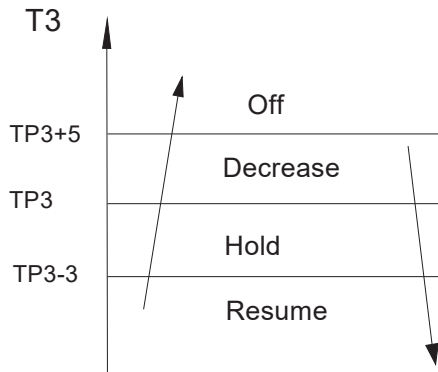

--- $TP3 < T3 < TP3+5$, the compressor frequency will decrease to the lower level until to F1 and then runs at F1. If $TP3-3 < T3 < TP3$, the compressor will keep running at the current frequency.

--- $T3 < TP3-3$, the compressor will not limit the frequency and resume to the former frequency.

--- $T3 > TP3+5$ for 5 seconds, the compressor will stop until $T3 < TP3-3$.

8.4.2.5 Evaporator temperature protection

When Evaporator temperature temp. is less than setting value, the compressor will stop.

8.4.3 Heating Mode

8.4.3.1 Compressor running rules

When $T1-Ts > \Delta T$, the compressor will stop, when $T1-Ts < \Delta T-1.5$, the compressor will be on. ΔT is the programmed parameter of temperature compensation.

When the AC run in mute mode, the compressor will run with low frequency.

When the current is more than setting value, the current protection function will be activated and the compressor will stop.

8.4.3.2 Outdoor fan running rules

The outdoor unit will be run at different fan speed according to T4.

For different outdoor units, the fan speeds are different.

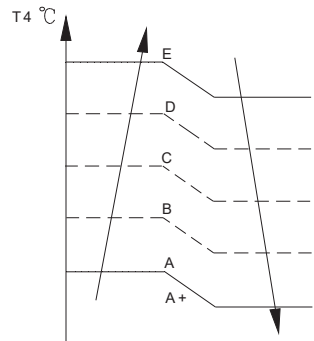

8.4.3.3 Indoor fan running rules

When the compressor is on, the indoor fan can be set to high/med/low/auto. And the anti-cold wind function has the priority.

The indoor fan is controlled as below:

Setting fan speed	T1-Td °C(°F)	Actual fan speed
H	A	H+ (H+=H+G)
	B	H (=H)
	C	H- (H-=H-G)
M	D	M+ (M+=M+Z)
	E	M (M=M)
	F	M- (M-=M-Z)
L	G	L+ (L+=L+D)
	H	L (L=L)
	I	L- (L-=L-D)

Auto fan action in heating mode:

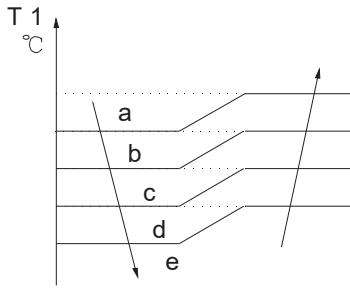

8.4.3.4 Defrosting mode

AC will enter the defrosting mode according to the value of temp. of T3 and the value range of temp. change of T3 and also the compressor running time.

During the defrosting mode, the compressor keep running, indoor and outdoor motor will stop, defrost lamp of the indoor unit will be lighted

“**DF**.” Will be displayed.

If any one of the following items is satisfied, the defrosting will finish and the machine will turn to normal heating mode.

----T3 rises to be higher than TCDE1°C.

----T3 keeps to be higher than TCDE2°C for 80 seconds.

----The machine has run for 15 minutes in defrosting mode.

8.4.3.5 Evaporator coil temperature protection

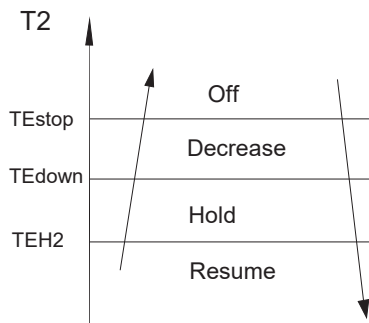

Off: Compressor stops.

Decrease: Decrease the running frequency to the lower level.

Hold: Keep the current frequency.

Resume: No limitation for frequency.

8.4.4 Auto-mode

This mode can be chosen with remote controller and the setting temperature can be changed

between 17°C~30°C

In auto mode, the machine will choose cooling, heating or fan-only mode according to ΔT ($\Delta T = T1 - Ts$).

$\Delta T = T1 - Ts$	Running mode
$\Delta T > 2^\circ\text{C}$	Cooling
$-2 \leq \Delta T \leq 2^\circ\text{C}$	Fan-only
$\Delta T < -2^\circ\text{C}$	Heating

Indoor fan will run at auto fan of the relevant mode.

The louver operates same as in relevant mode.

If the machine switches mode between heating and cooling, the compressor will keep stopping for 15 minutes and then choose mode according to T1-Ts.

If the setting temperature is modified, the machine will choose running function again.

8.4.5 Drying mode

Indoor fan speed is fixed at breeze and can't be changed. The louver angle is the same as in cooling mode.

All protections are active and the same as that in cooling mode.

8.4.6 Forced operation function

Forced cooling mode:

The compressor and outdoor fan keep running and the indoor fan runs at low speed. After running for 30 minutes, AC will turn to auto mode with 24°C setting temperature.

Forced auto mode:

The action of forced auto mode is the same as normal auto mode with 24°C setting temperature. When AC receives signals, such as switch on, switch off, timer on, timer off, mode setting, fan speed setting, sleeping mode setting, follow me setting, it will quit the forced operation.

8.4.7 Timer function

8.4.7.1 Timing range is 24 hours.

8.4.7.2 Timer on. The machine will turn on automatically when reaching the setting time.

8.4.7.3 Timer off. The machine will turn off automatically when reaching the setting time.

8.4.7.4 Timer on/off. The machine will turn on automatically when reaching the setting “on” time, and then turn off automatically when reaching the setting “off” time.

8.4.7.5 Timer off/on. The machine will turn off automatically when reaching the setting “off” time, and then turn on automatically when reaching the setting “on” time.

8.4.7.6 The timer function will not change the AC current operation mode. Suppose AC is off now, it will not start up firstly after setting the “timer off” function. And when reaching the setting time, the timer LED will be off and the AC running mode has not been changed.

8.4.7.7 The setting time is relative time.

8.4.7.8 The AC will quit the timer function when it has malfunction.

8.4.8 Sleep function

8.4.8.1 The sleep function is available in cooling, heating or auto mode.

8.4.8.2. Operation process in sleep mode is as follow:

When cooling, the setting temperature rises 1°C (be lower than 30°C) every one hour, 2 hours later the setting temperature stops rising and the indoor fan is fixed at low speed.

When heating, the setting temperature decreases 1°C (be higher than 17°C) every one hour, 2 hours later the setting temperature stops rising and indoor fan is fixed at low speed. (Anti-cold wind function has the priority).

8.4.8.3 Operation time in sleep mode is 7 hours. After 7 hours the AC quits this mode and turns off.

8.4.8.4 Timer setting is available

8.4.9 Auto-Restart function

The indoor unit is equipped with auto-restart function, which is carried out through an auto-restart module. In case of a sudden power failure, the module memorizes the setting conditions before the power failure. The unit will resume the previous operation setting (not including swing function) automatically after 3 minutes when power returns.

If the memorization condition is forced cooling

mode, the unit will run in cooling mode for 30 minutes and turn to auto mode as 24°C setting temp.

If AC is off before power off and AC is required to start up now, the compressor will have 1 minute delay when power on. Other conditions, the compressor will have 3 minutes delay when restarts.

8.4.10 Refrigerant Leakage Detection

With this new technology, the display area will show “EC” when the outdoor unit detects refrigerant leakage. This function is only available in cooling mode.

8.4.11 Louver Position Memory Function

When starting the unit again after shutting down, its louver will restore to the angle originally set by the user, but the precondition is that the angle must be within the allowable range, if it exceeds, it will memorize the maximum angle of the louver. During operation, if the power fails or the end user shuts down the unit in the turbo mode, the louver will restore to the default angle.

8.4.12 8°C Heating(optional)

In heating operation, the preset temperature of the air conditioner can be as lower as 8°C, which keeps the room temperature steady at 8°C and prevents household things freezing when the house is unoccupied for a long time in severe cold weather.

8.4.13 Self clean(optional)

For heat pump models which are provided with this function, after running in cooling or drying mode, if the user press “Self Clean” button on remote controller, firstly, indoor unit runs in fan only mode for a while, then low heat operation and finally runs in fan only again. This function can keep the inside of indoor unit dry and prevent breeding of mold.

8.4.14 Follow me (optional)

1) If the indoor PCB receives the signal which

results from pressing the FOLLOW ME button on remote controller, the buzzer will emit a sound and this indicates the follow me function is initiated. But when the indoor PCB receives signal which sent from remote controller every 3 minutes, the buzzer will not respond. When the unit is running with follow me function, the PCB will control the unit according to the temperature from follow me signal, and the temperature collection function of room temperature sensor will be shielded, but the error detective function of room temperature sensor will be still valid.

- 2) When the follow me function is available, the PCB will control the unit according to the room temperature from the remote controller and the setting temperature.
- 3) The PCB will take action to the mode change information from remote controller signal, but it will not be affected by the setting temperature.

4) When the unit is running with follow me function, if the PCB doesn't receive any signal from remote controller for 7 minutes or pressing FOLLOW ME button again, the follow me function will be turned off automatically, and the temperature will control the unit according to the room temperature detected from its own room temperature sensor and setting temperature.

8.4.15 Silence operation(optional)

Press the "silence" button on remote controller to initiate SILENCE function. When the Silence function is activated, the compressor running frequency will keep lower than F2 and the indoor unit will bring faint breeze, which will reduce the noise to the lowest level and create a quiet and comfortable room for you.

8.4.16 Point check function

Press the LED DISPLAY or LED or MUTE button of the remote controller three times, and then press the AIR DIRECTION or SWING button three times in ten seconds, the buzzer will keep ring for two seconds. The air conditioner will enter into the information enquiry status. You can press the LED DISPLAY or AIR DIRECTION button to check the next or front item's information.

When the AC enter the "information enquiry" status, it will display the code name in 2 seconds, the details are as follows.

Enquiry information	Displaying code	Meaning
T1	T1	T1 temp.
T2	T2	T2 temp.
T3	T3	T3 temp.
T4	T4	T4 temp.
T2B	Tb	T2B temp.

TP	TP	TP temp.
TH	TH	TH temp.
Targeted Frequency	FT	Targeted Frequency
Actual Frequency	Fr	Actual Frequency
Indoor fan speed	IF	Indoor fan speed
Outdoor fan speed	OF	Outdoor fan speed
EXV opening angle	LA	EXV opening angle
Compressor continuous running time	CT	Compressor continuous running time
Causes of compressor stop.	ST	Causes of compressor stop.
Reserve	A0	
Reserve	A1	
Reserve	b 0	
Reserve	b 1	
Reserve	b 2	
Reserve	b 3	
Reserve	b 4	
Reserve	b 5	
Reserve	b 6	
Reserve	d L	
Reserve	A c	
Reserve	U o	
Reserve	T d	

When the AC enter into the information enquiry status, it will display the code value in the next 25s, the details are as follows.

Enquiry information	Display value	Meaning	Remark
T1,T2,T3,T4, T2B,TP,TH, Targeted Frequency, Actual Frequency	-1F,-1E,-1d,-1c,-1b,-1A	-25,-24,-23,-22,-21,-20	1. All the displaying temperature is actual value. 2. All the temperature is °C no matter what kind of remote controller is used. 3. T1,T2,T3,T4,T2B display range:-25~70, TP display range:-20~130. 4. Frequency display range: 0~159HZ. 5. If the actual value exceeds the range, it will display the maximum value or minimum value.
	-19—99	-19—99	
	A0,A1,...A9	100,101,...109	
	b0,b1,...b9	110,111,...119	
	c0,c1,...c9	120,121,...129	
	d0,d1,...d9	130,131,...139	
	E0,E1,...E9	140,141,...149	
F0,F1,...F9	150,151,...159		
Indoor fan speed /Outdoor fan speed	0	OFF	For some big capacity motors.
	1,2,3,4	Low speed, Medium speed, High speed, Turbo	

	14-FF	Actual fan speed=Display value turns to decimal value and then multiply 10. The unit is RPM.	For some small capacity motors, display value is from 14-FF(hexadecimal), the corresponding fan speed range is from 200-2550RPM.
EXV opening angle	0-FF	Actual EXV opening value=Display value turns to decimal value and then multiply 2.	
Compressor continuous running time	0-FF	0-255 minutes	If the actual value exceeds the range, it will display the maximum value or minimum value.
Causes of compressor stop.	0-99	For the detailed meaning, please consult with engineer	Decimal display
Reserve	0-FF		

9. Troubleshooting

Safety

Electricity power is still kept in capacitors even the power supply is shut off. Do not forget to discharge the electricity power in capacitor.

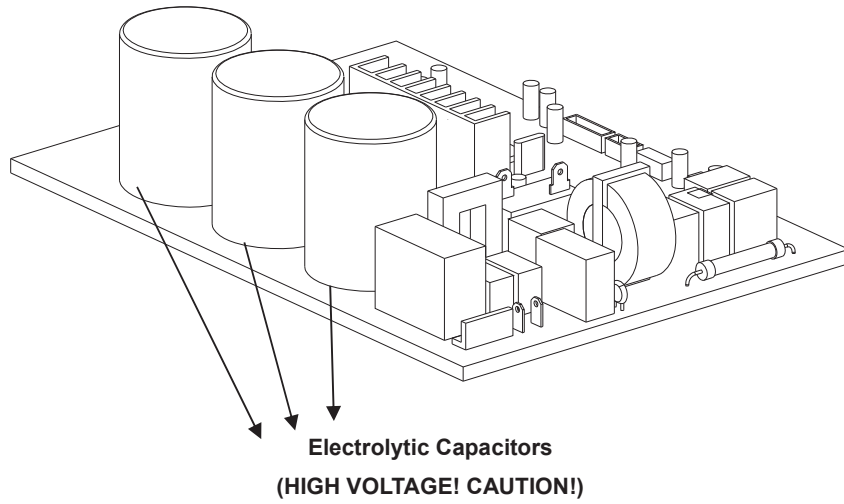

For other models, please connect discharge resistance (approx. 100Ω 40W) or soldering iron (plug) between +, - terminals of the electrolytic capacitor on the contrary side of the outdoor PCB.

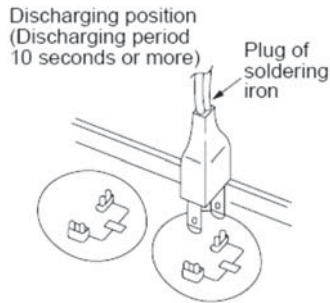

Note: The picture above is only for reference. The plug of your side may be different.

9.1 Indoor Unit Error Display

Operation lamp	Timer lamp	Display	LED STATUS
☆ 1 time	X	E0	Indoor unit EEPROM parameter error
☆ 2 times	X	E1	Indoor / outdoor units communication error
☆ 3 times	X	E2	Zero-crossing signal detection error
☆ 4 times	X	E3	Indoor fan speed has been out of control
☆ 5 times	X	E4	Indoor room temperature sensor T1 open circuit or short circuit
☆ 6 times	X	E5	Evaporator coil temperature sensor T2 open circuit or short circuit
☆ 7 times	X	EC	Refrigerant leakage detection
☆ 1 times	O	F0	Overload current protection
☆ 2 times	O	F1	Outdoor ambient temperature sensor T4 open circuit or short circuit
☆ 3 times	O	F2	Condenser coil temperature sensor T3 open circuit or short circuit
☆ 4 times	O	F3	Compressor discharge temperature sensor TP open circuit or short circuit
☆ 5 times	O	F4	Outdoor unit EEPROM parameter error
☆ 6 times	O	F5	Outdoor fan speed has been out of control
☆ 1 times	☆	P0	IPM malfunction or IGBT over-strong current protection
☆ 2 times	☆	P1	Over voltage or over low voltage protection
☆ 3 times	☆	P2	High temperature protection of IPM module or compressor top
☆ 4 times	☆	P3*	Outdoor ambient temperature too low.
☆ 5 times	☆	P4	Inverter compressor drive error
☆ 6 times	☆	P5	Indoor units mode conflict (multi-zone ONLY)
☆ 7 times	☆	P6	Low pressure protection(Only for 36K)

O (light) X (off) ☆ (flash)

*P3

- 1) In heating mode, when the outdoor temperature is lower than -25°C for 1 hour, the indoor unit display error code P3.
- 2) If the outdoor temperature is higher than -22°C for 10 minutes and compressor stop for 1 hour or outdoor temperature is higher than -5°C for 10 minutes, then the unit will return to work.

* **Fault Symptom:** The display board shows a garbled code or a code that is not an error code found in the service manual nor a temperature reading.

Trouble shooting:

Use the remote controller. If the unit does not respond to the remote, the indoor PCB needs to be replaced; if the unit does respond, then the display board needs to be replaced.

9.2 Outdoor unit error display (TBD)

For WYS009AMFI17RL, WYS012AMFI17RL, WYS009AMFI22RL, WYS012AMFI22RL

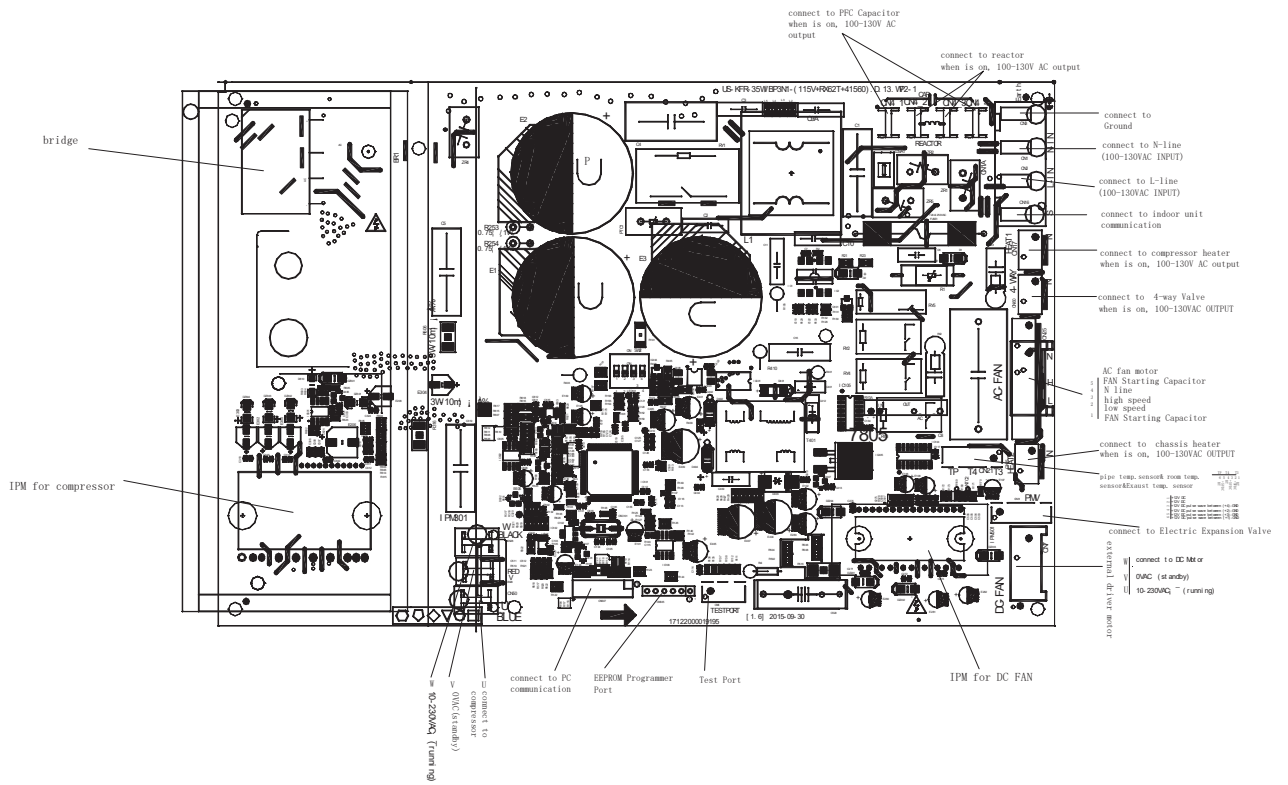

**For WYS009GMFI17RL, WYS012GMGI17RL, WYS018GMFI17RL, WYS024GMFI17RL
WYS009GMFI22RL, WYS012GMFI22RL, WYS018GMFI22RL**

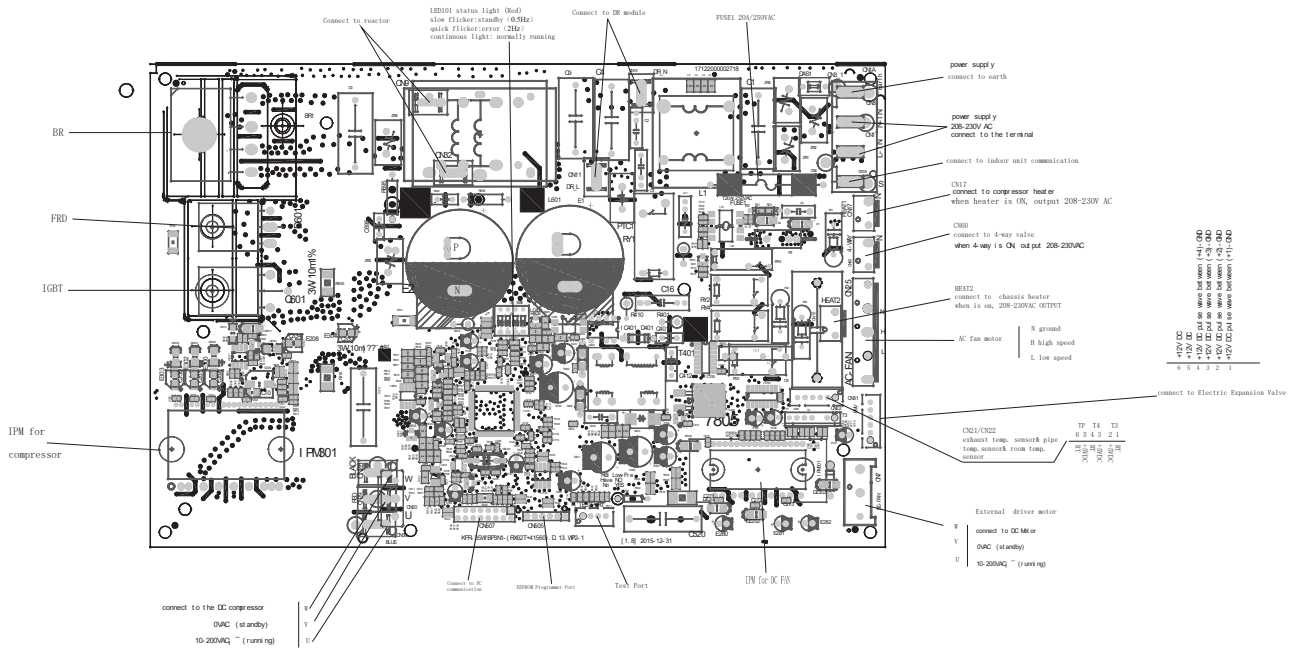

After power is turned on, LED3 (Green color) and LED2 (Red color) will flash if the unit has problems.

No.	Problems	LED3 (Green)	LED2 (Red)	IU display
1	standby for normal	O	X	
2	Operation normally	X	O	
3	IPM malfunction or IGBT over-strong current protection	☆	X	P0
4	Over voltage or too low voltage protection	O	O	P1
5	EEPROM parameter error	O	☆	E5
6	Inverter compressor drive error	X	☆	P4
7	Inverter compressor drive error	☆	O	P4
8	Inverter compressor drive error	☆	☆	P4

O (light) X (off) ☆ (2.5Hz flash)

IPM board,

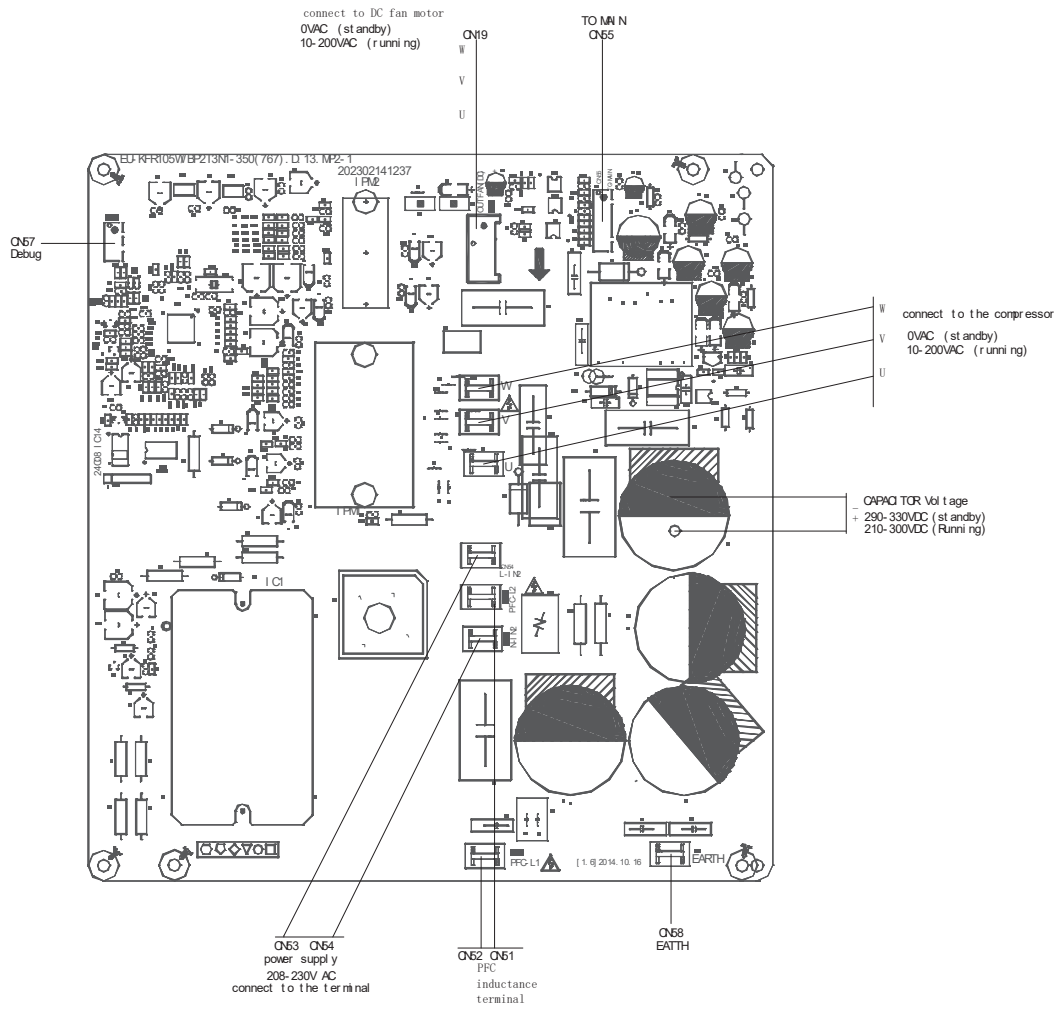

9.3 Diagnosis and Solution

9.3.1 EEPROM parameter error diagnosis and solution (E0/F4)

Error Code	E0/F4
Malfunction decision conditions	Indoor or outdoor PCB main chip does not receive feedback from EEPROM chip.
Supposed causes	<ul style="list-style-type: none">● Installation mistake● PCB faulty

Trouble shooting:

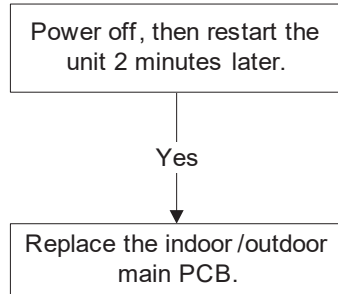

EEPROM: a read-only memory whose contents can be erased and reprogrammed using a pulsed voltage. For the location of EEPROM chip, please refer to the below photos.

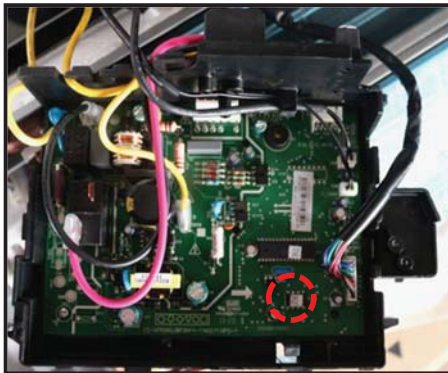

Indoor PCB

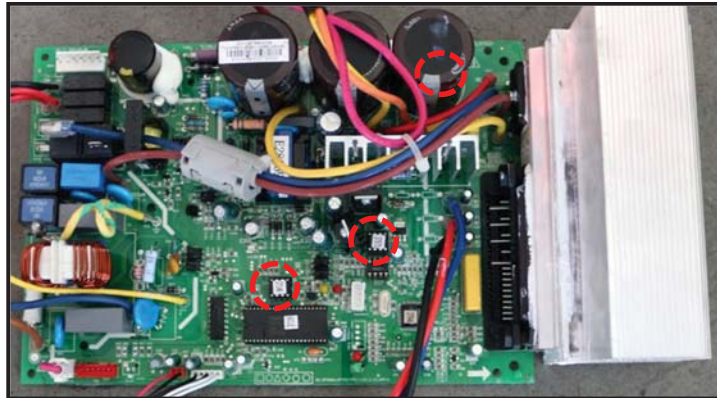

Outdoor PCB

Note: The two photos above are only for reference, it may be not identical to the product you have.

9.3.2 Indoor / outdoor unit's communication diagnosis and solution (E1)

Error Code	E1
Malfunction decision conditions	Indoor unit does not receive the feedback from outdoor unit during 110 seconds and this condition happens four times continuously.
Supposed causes	<ul style="list-style-type: none"> ● Wiring mistake ● Indoor or outdoor PCB faulty

Trouble shooting:

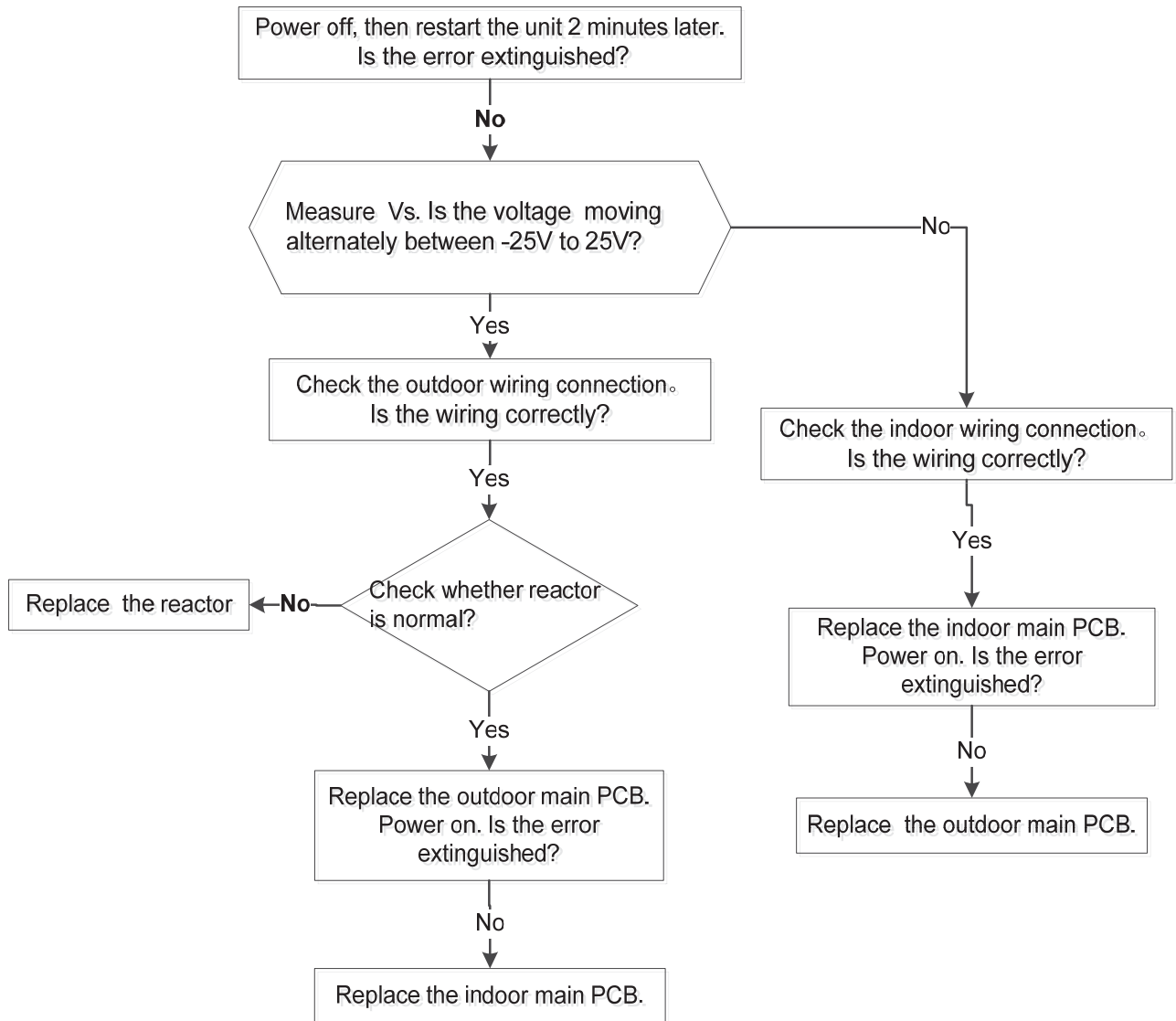

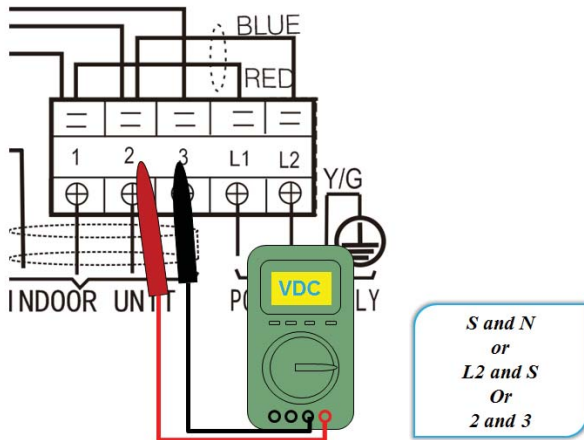

Remark:

Use a multimeter to test the DC voltage between 2 port and 3 port of outdoor unit. The red pin of multimeter connects with 2 port while the black pin is for 3 port.

When system is normally running, the voltage will move alternately between - 25V to 25V.

If the outdoor unit has malfunction, the voltage will move alternately within positive values.

While if the indoor unit has malfunction, the voltage will be a certain fixed value.



Remark:

Use a multimeter to test the resistance of the reactor which does not connect with capacitor.

The normal value should be around zero ohm. Otherwise, the reactor must have malfunction.

9.3.3 Zero crossing detection error diagnosis and solution (E2)

Error Code	E2
Malfunction decision conditions	When PCB does not receive zero crossing signal feedback for 4 minutes or the zero crossing signal time interval is abnormal.
Supposed causes	<ul style="list-style-type: none">● Connection mistake● PCB faulty

Trouble shooting:

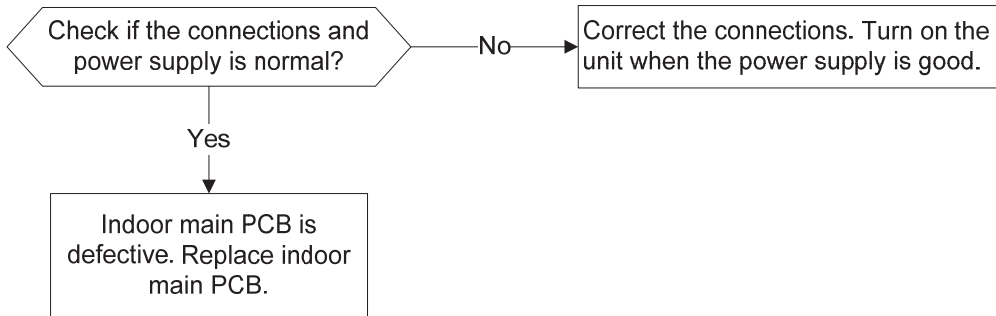

9.3.4 Fan speed has been out of control diagnosis and solution(E3)

Error Code	E3/F5
Malfunction decision conditions	When indoor fan speed stays too low (300RPM) for certain time, the unit will stop and the LED will display the failure.
Supposed causes	<ul style="list-style-type: none"> ● Wiring mistake ● Fan ass'y faulty ● Fan motor faulty ● PCB faulty

Trouble shooting:

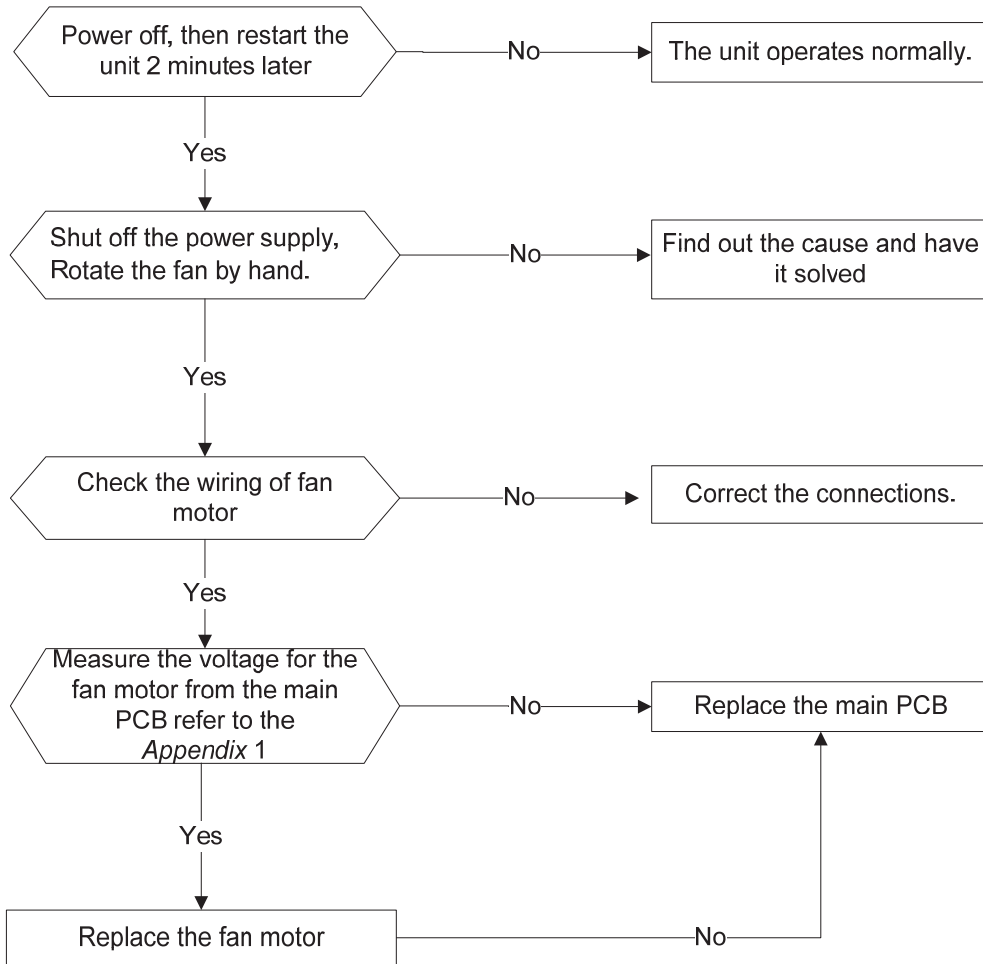

Index 1:

1:Indoor or Outdoor DC Fan Motor(control chip is in fan motor)

Power on and when the unit is in standby, measure the voltage of pin1-pin3, pin4-pin3 in fan motor connector. If the value of the voltage is not in the range showing in below table, the PCB must has problems and need to be replaced.

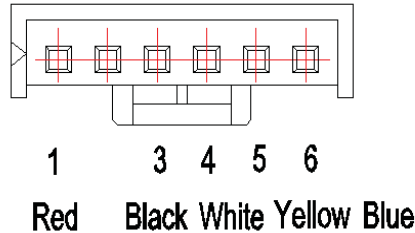

DC motor voltage input and output(voltage: 220-240V~)

NO.	Color	Signal	Voltage
1	Red	Vs/Vm	280V~380V
2	---	---	---
3	Black	GND	0V
4	White	Vcc	14-17.5V
5	Yellow	Vsp	0~5.6V
6	Blue	FG	14-17.5V

DC motor voltage input and output(voltage :115V~)

NO.	Color	Signal	Voltage
1	Red	Vs/Vm	140V~190V
2	---	---	---
3	Black	GND	0V
4	White	Vcc	14-17.5V
5	Yellow	Vsp	0~5.6V
6	Blue	FG	14-17.5V

2. Outdoor DC Fan Motor (control chip is in outdoor PCB)

Power on ,and check if the fan can run normally, if the fan can run normally, the PCB must have problems and need to be replaced, If the fan can't run normally, measure the resistance of each pairs of pins. If the resistance is not equal to each other, the fan motor must have problems and need to be replaced, otherwise the PCB must have problems and need to be replaced.

3. Indoor AC Fan Motor

Turn power on and set the unit running in fan mode at high fan speed. After running for 15 seconds, measure the voltage of pin1 and pin2. If the value of the voltage is less than 100V (208~240V power supply) or 50V (115V power supply), the PCB must have problems and need to be replaced.

9.3.5 Open circuit or short circuit of temperature sensor diagnosis and solution (E5)

Error Code	E4/E5/F1/F2/F3
Malfunction decision conditions	If the sampling voltage is lower than 0.06V or higher than 4.94V, the LED will display the failure.
Supposed causes	<ul style="list-style-type: none"> ● Wiring mistake ● Sensor faulty

Trouble shooting:

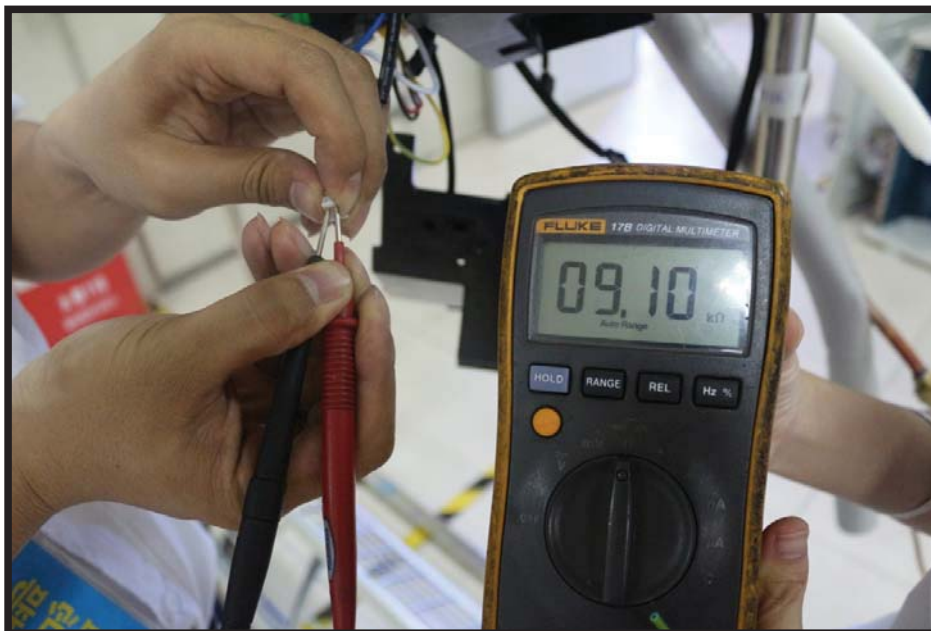
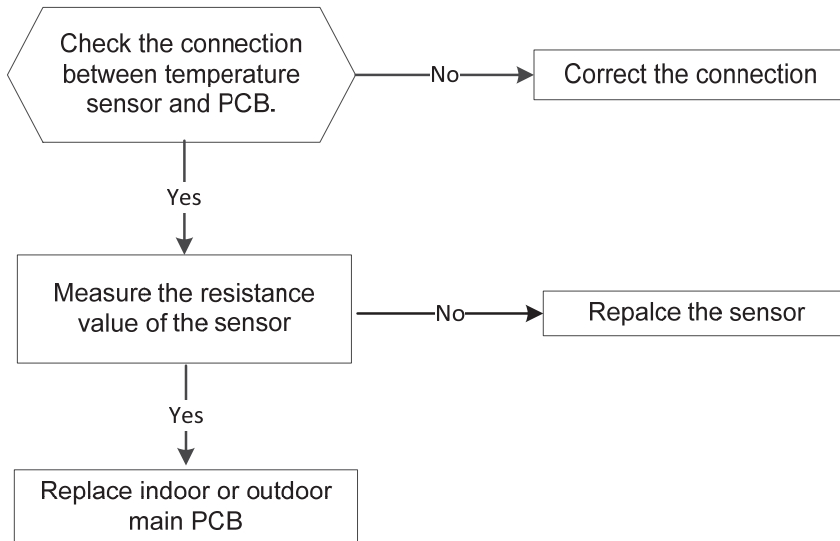

9.3.6 Refrigerant Leakage Detection diagnosis and solution (EC)

Error Code	EC
Malfunction decision conditions	<p>Define the evaporator coil temp. T2 of the compressor just starts running as Tcool.</p> <p>In the beginning 5 minutes after the compressor starts up, if $T2 < T_{cool} - 2^{\circ}\text{C}$ ($T_{cool} - 35.6^{\circ}\text{F}$) does not keep continuous 4 seconds and this situation happens 3 times, the display area will show "EC" and AC will turn off.</p>
Supposed causes	<ul style="list-style-type: none"> ● T2 sensor faulty ● Indoor PCB faulty ● System problems, such as leakage or blocking.

Trouble shooting:

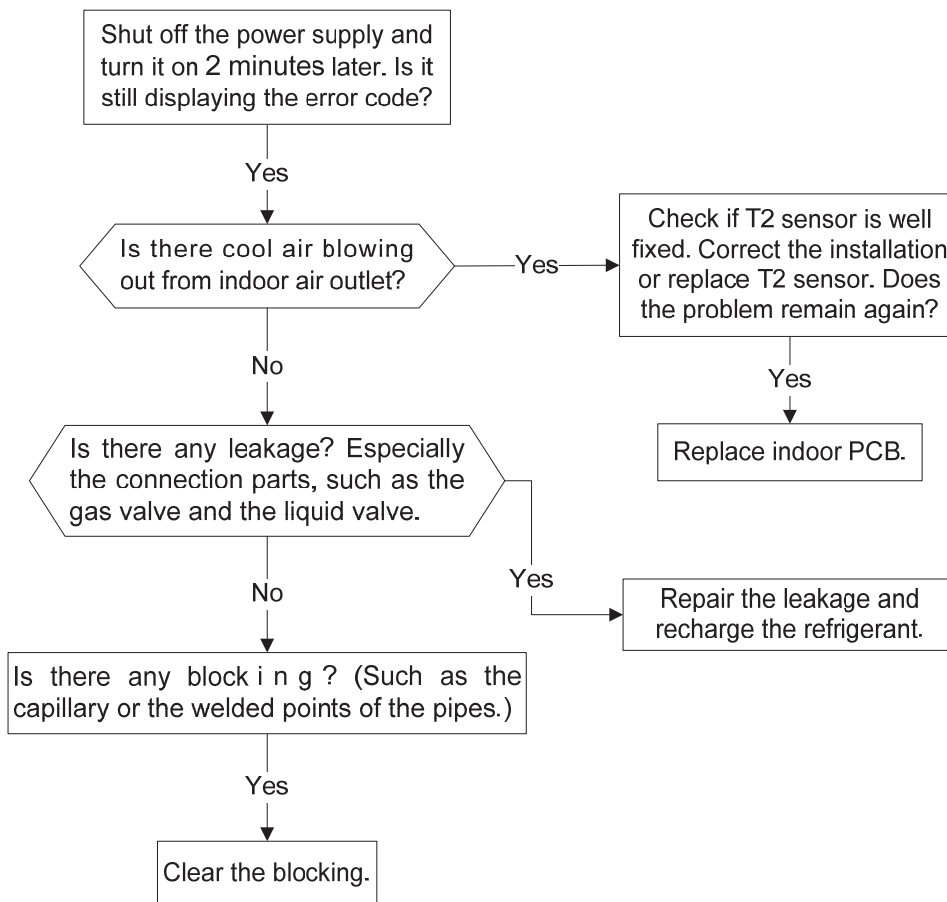

9.3.6 Overload current protection diagnosis and solution (F0)

Error Code	F0
Malfunction decision conditions	An abnormal current rise is detected by checking the specified current detection circuit.
Supposed causes	<ul style="list-style-type: none"> ● Power supply problems. ● System blockage ● PCB faulty ● Wiring mistake ● Compressor malfunction

Trouble shooting:

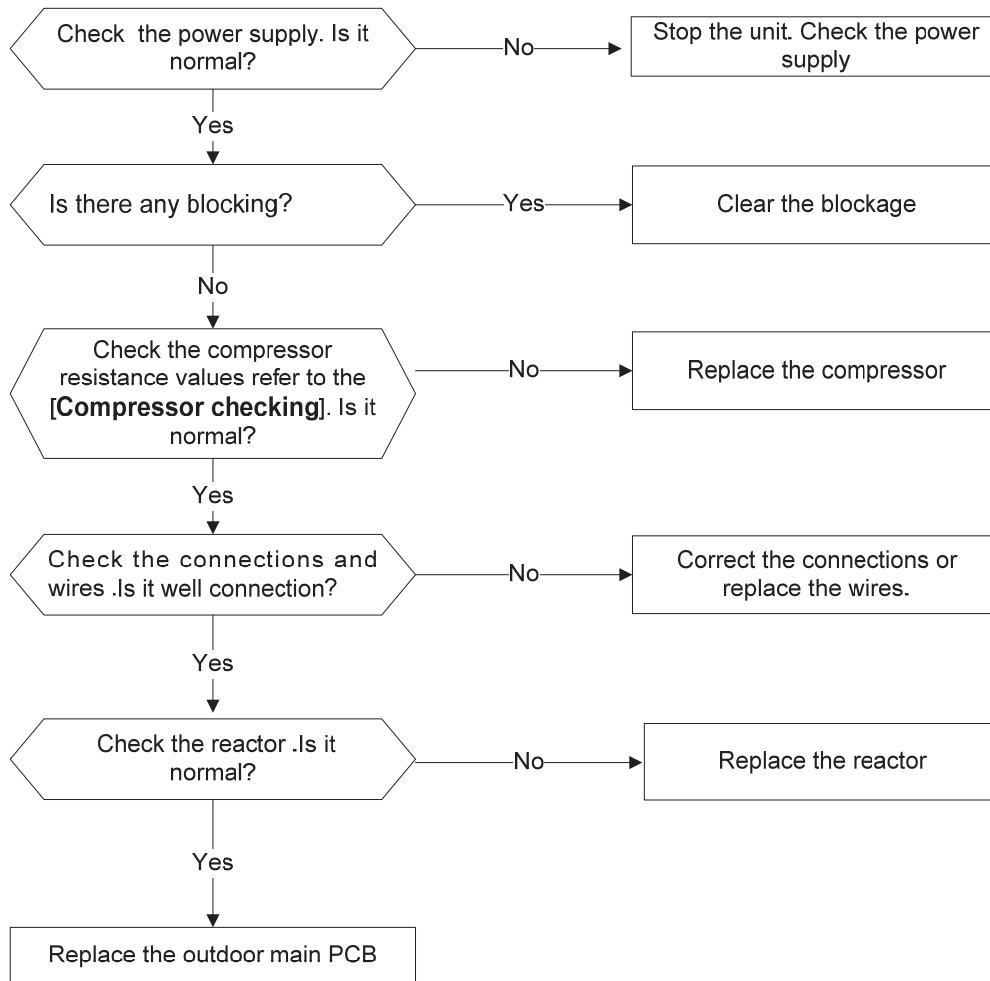

9.3.7 IPM malfunction or IGBT over-strong current protection diagnosis and solution (P0)

Error Code	P0
Malfunction decision conditions	When the voltage signal that IPM send to compressor drive chip is abnormal, the display LED will show “P0” and AC will turn off.
Supposed causes	<ul style="list-style-type: none"> ● Wiring mistake ● IPM malfunction ● Outdoor fan ass'y faulty ● Compressor malfunction ● Outdoor PCB faulty

Trouble shooting:

For 9K~24K:

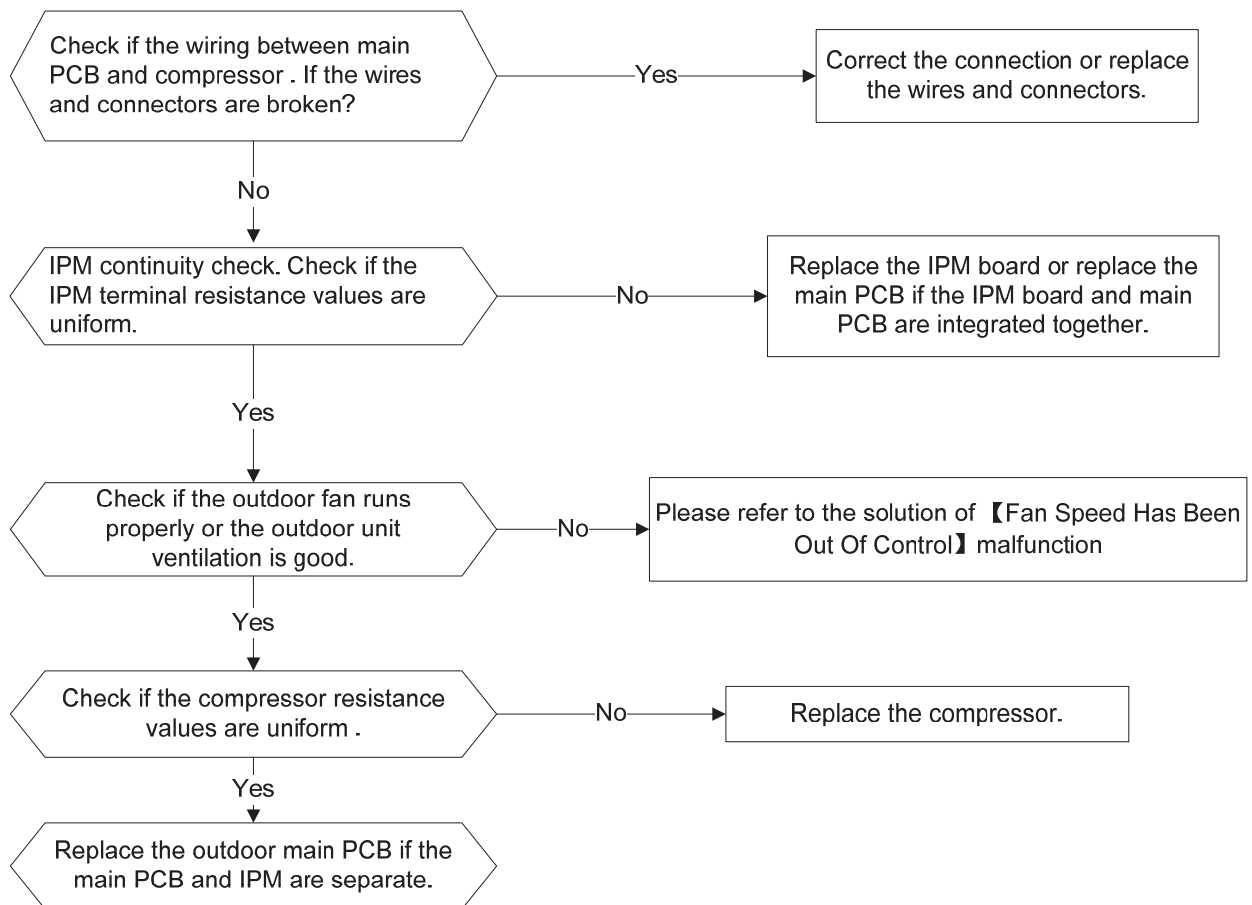

For example:

Note: The photos below are only for reference, actual product you have may be slightly different.

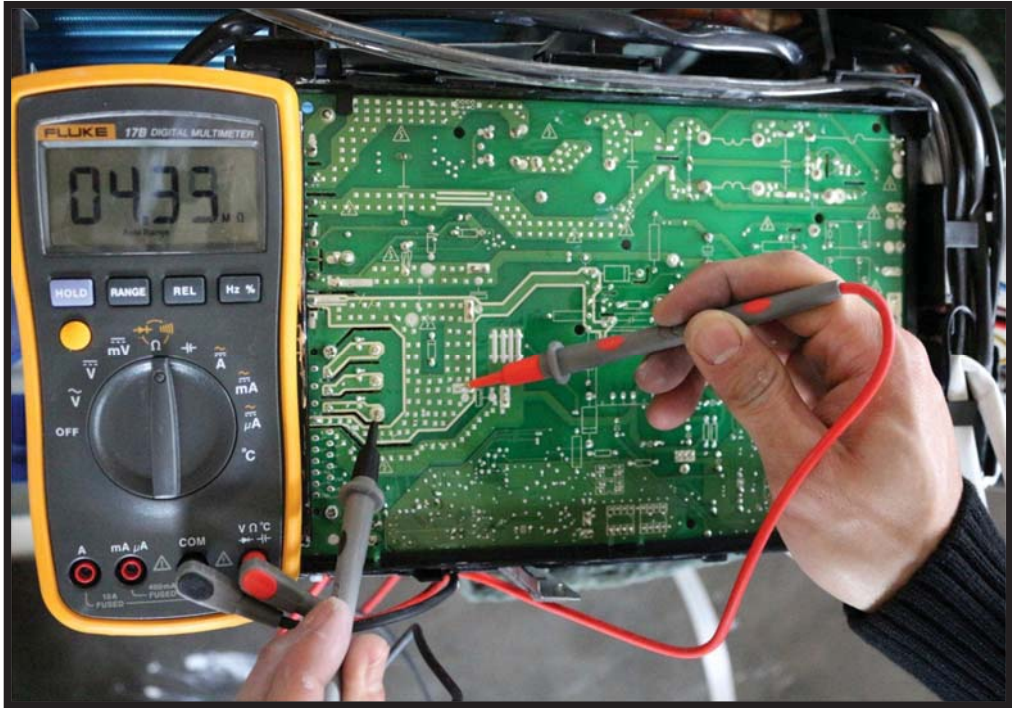

P-U

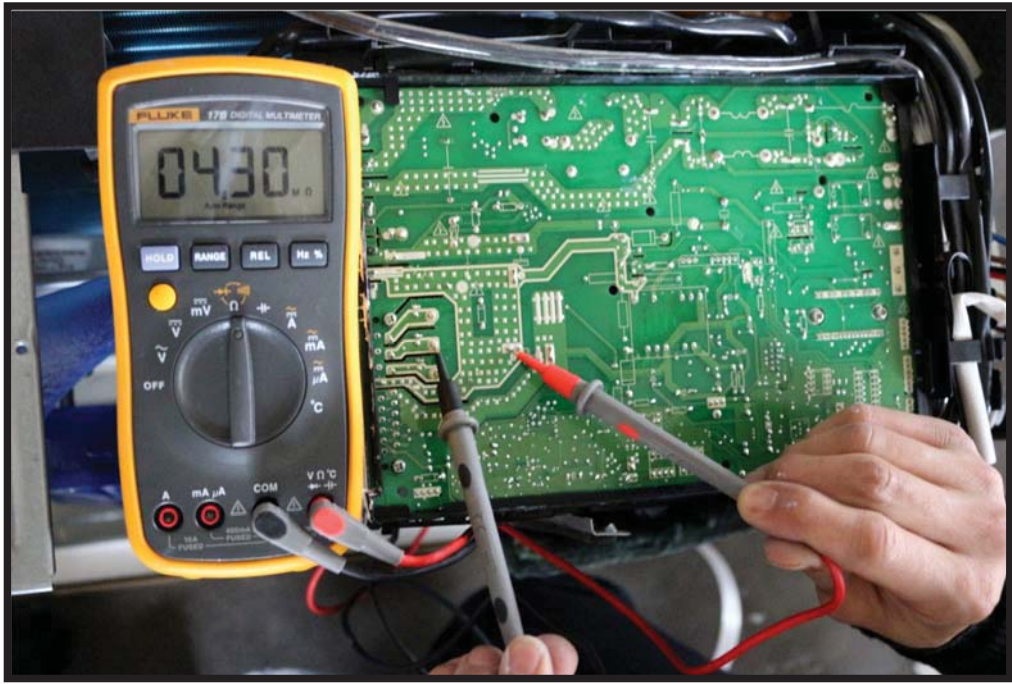

P-V

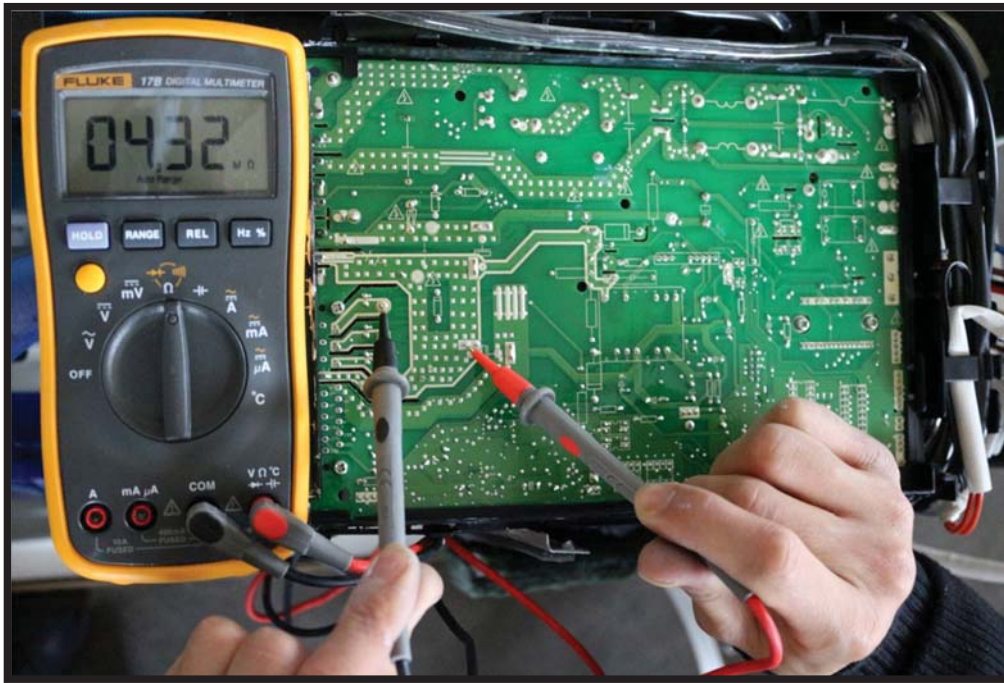

P-W

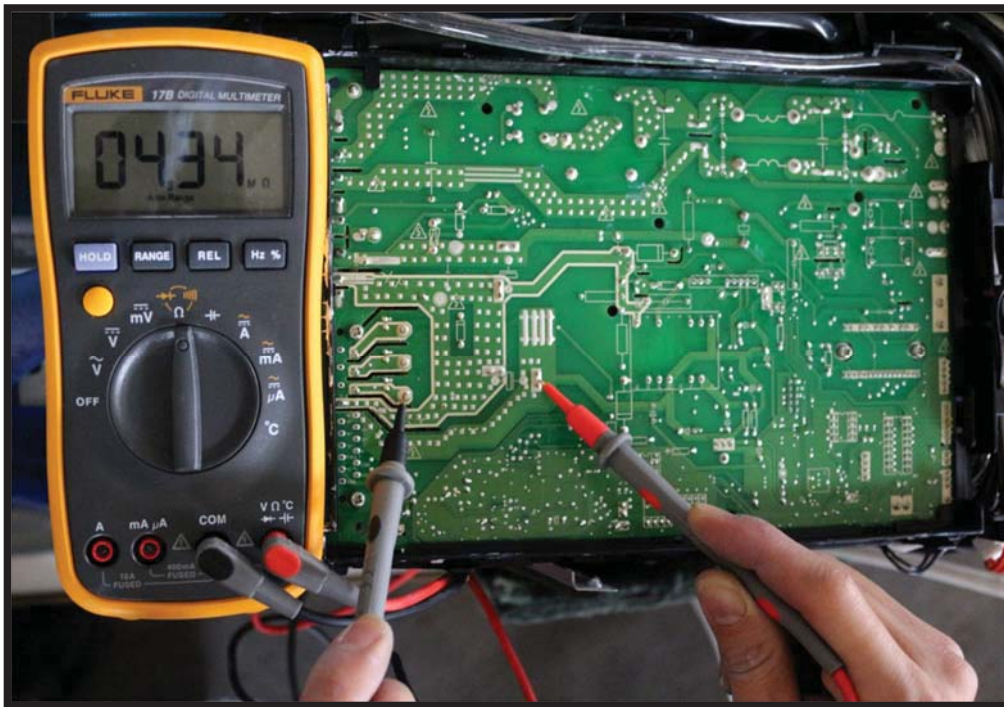

N-U

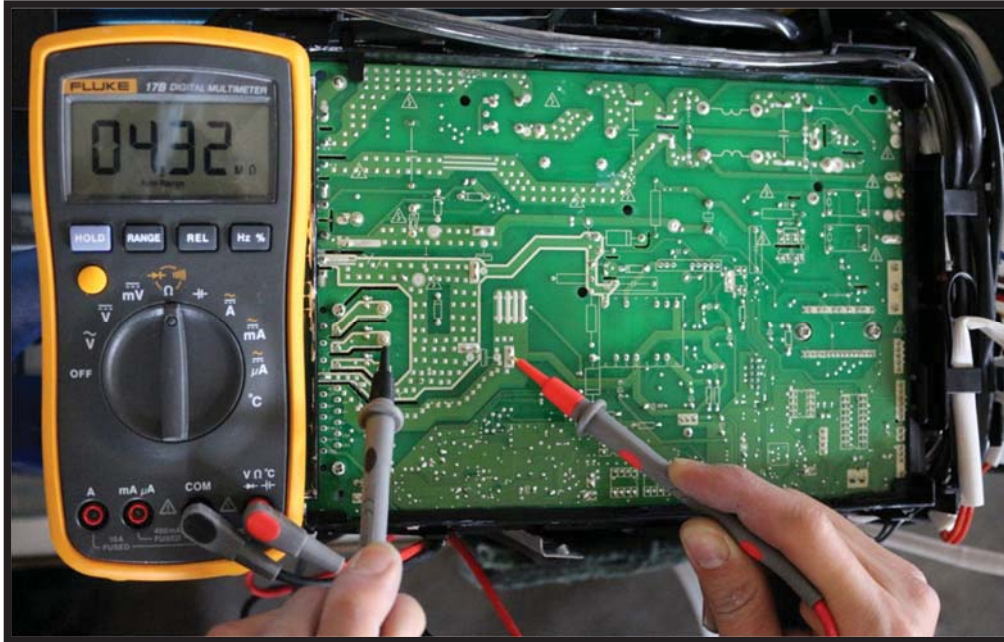

N-V

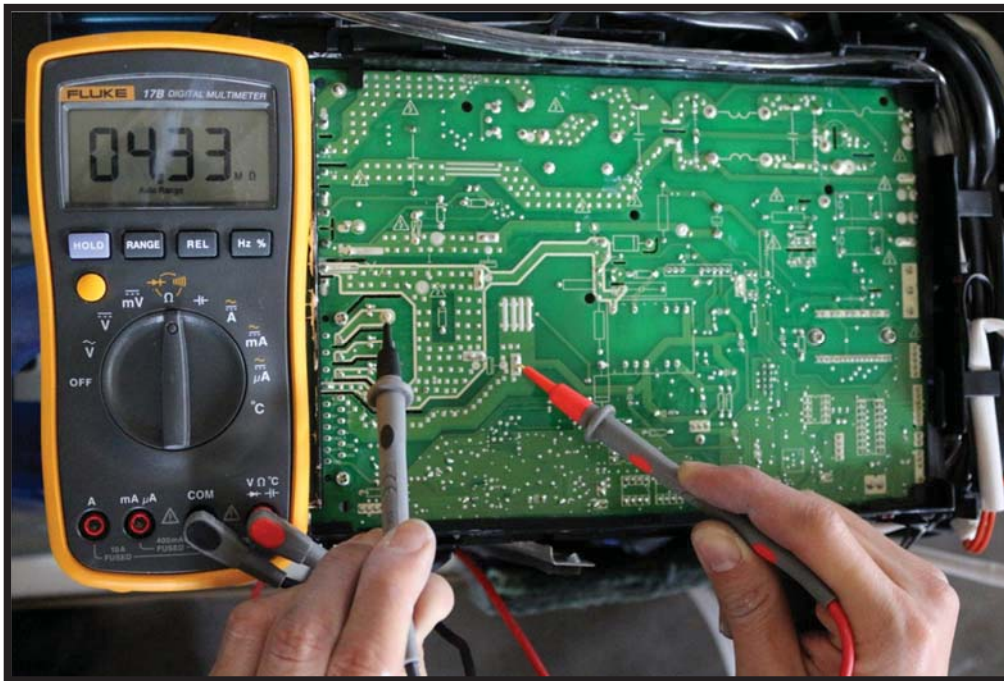

N-W

For 30K~36K:

At first test the resistance between every two ports of U, V, W of IPM and P, N. If any result of them is 0 or close to 0, the IPM is defective. Otherwise, please follow the procedure below:

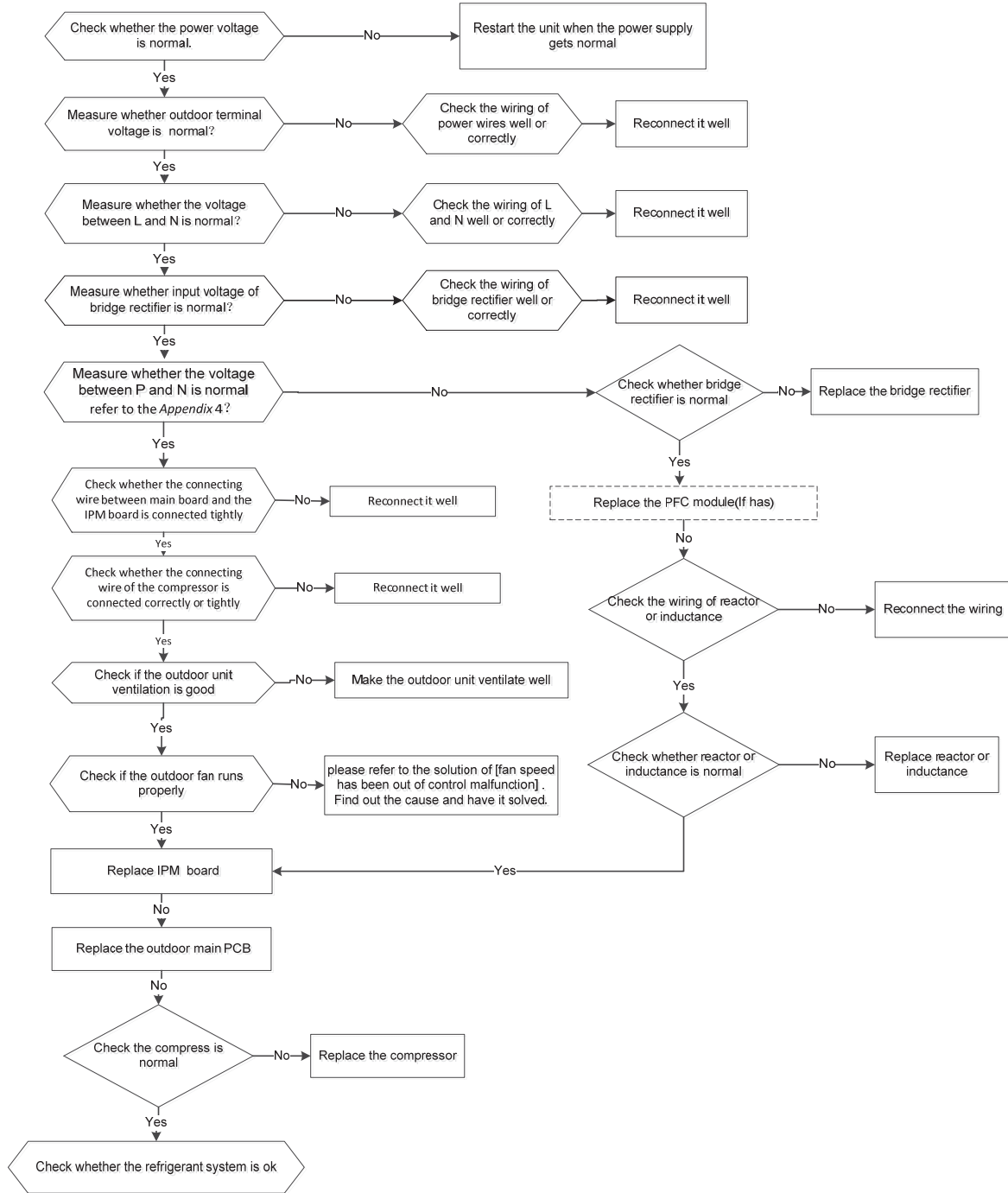

9.3.8 Over voltage or too low voltage protection diagnosis and solution (P1)

Error Code	P1
Malfunction decision conditions	An abnormal voltage rise or drop is detected by checking the specified voltage detection circuit.
Supposed causes	<ul style="list-style-type: none"> ● Power supply problems. ● System leakage or block ● PCB faulty

Trouble shooting:

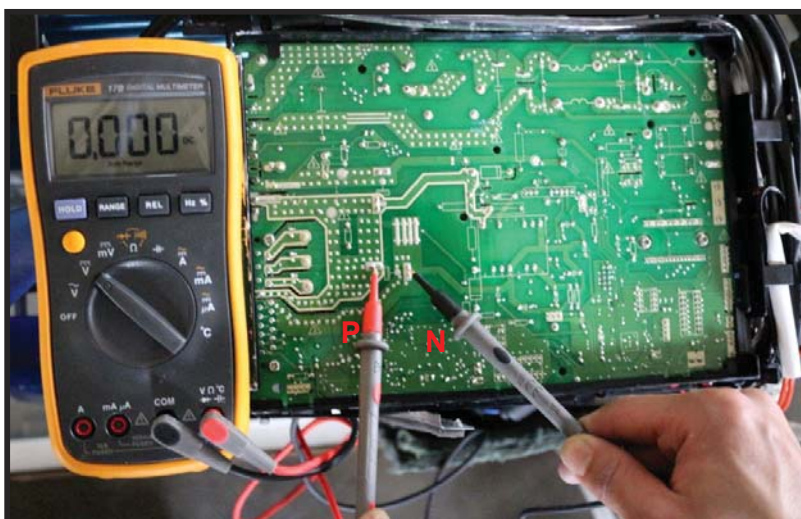
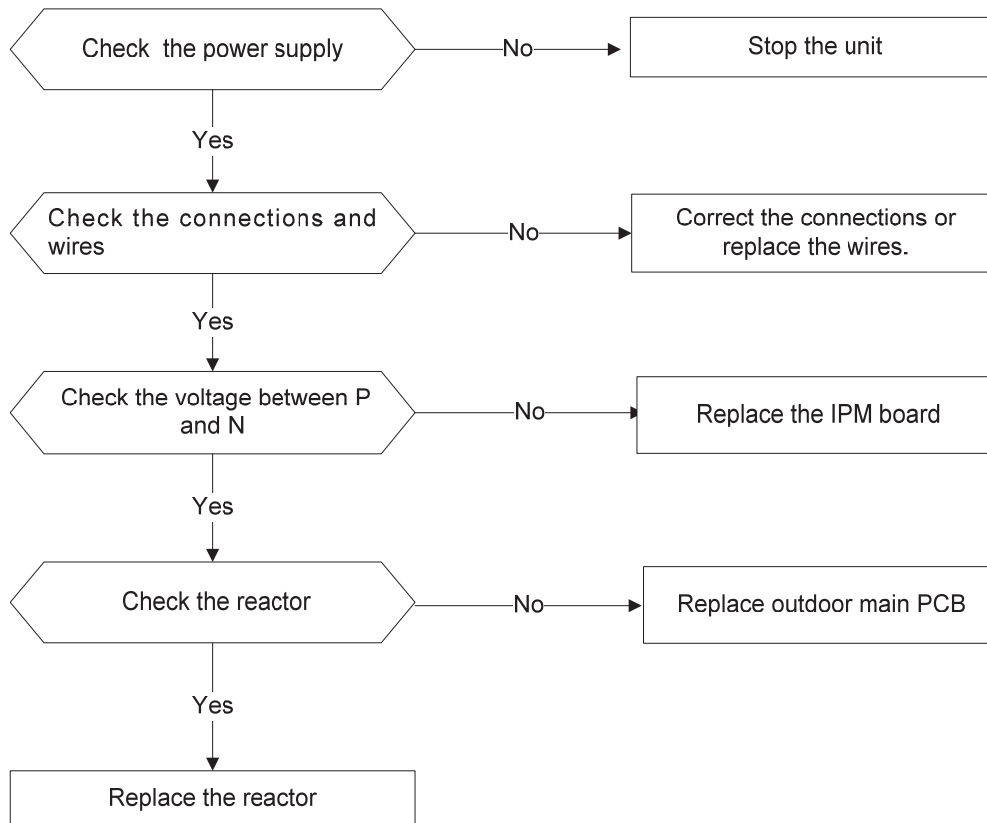

Remark:
 Measure the DC voltage between P and N port. The normal value should be around 310V.

9.3.9 High temperature protection of IPM module or compressor top diagnosis and solution (P2)

Error Code	P2
Malfunction decision conditions	If the sampling voltage is not 5V, the LED will display the failure.
Supposed causes	<ul style="list-style-type: none"> ● Installation mistake ● Power supply problems. ● System leakage or block ● PCB faulty

Trouble shooting:

For 18K, 24K,

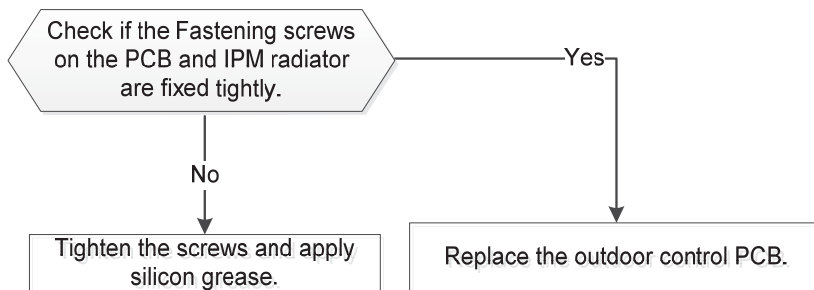

For other models,

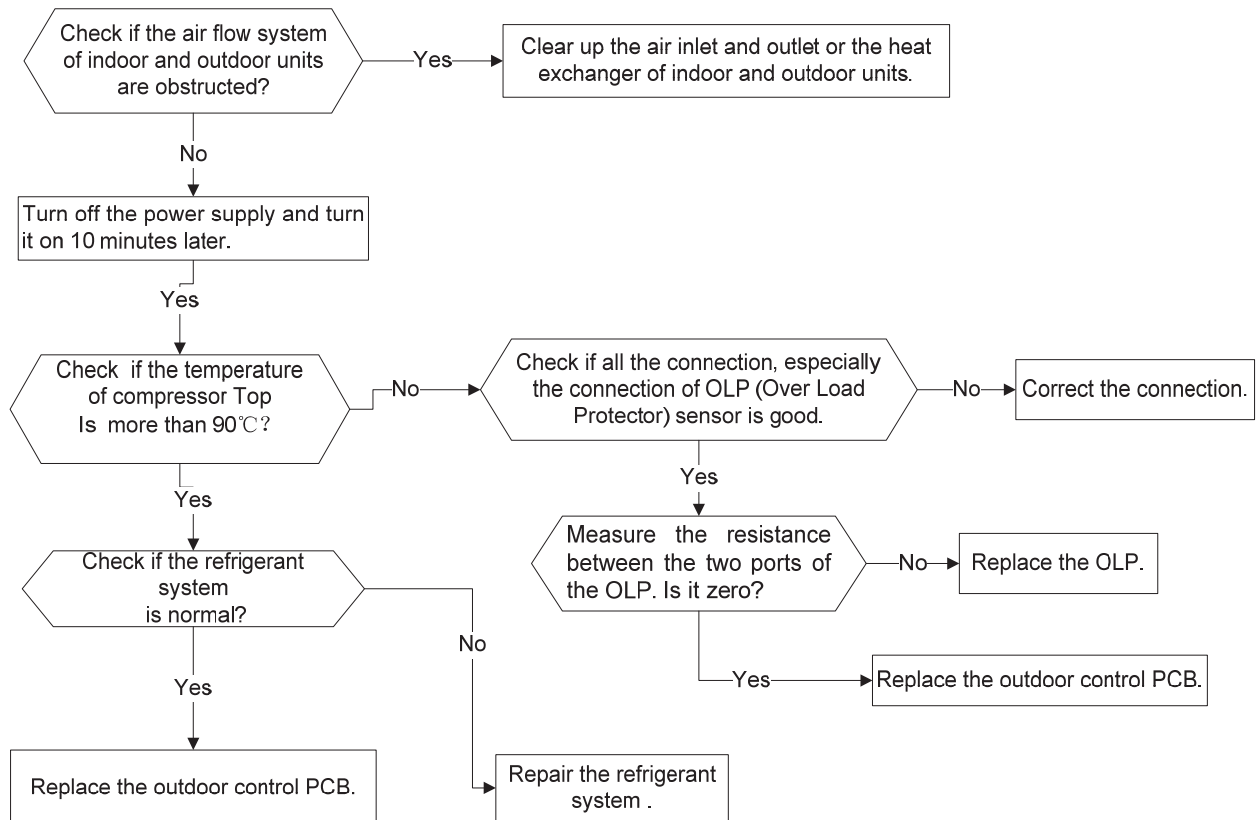

9.3.10 Inverter compressor drive error diagnosis and solution (P4)

Error Code	P4
Malfunction decision conditions	An abnormal inverter compressor drive is detected by a special detection circuit, including communication signal detection, voltage detection, compressor rotation speed signal detection and so on.
Supposed causes	<ul style="list-style-type: none"> ● Wiring mistake ● IPM malfunction ● Outdoor fan ass'y faulty ● Compressor malfunction ● Outdoor PCB faulty

Trouble shooting:

For 9K~24K:

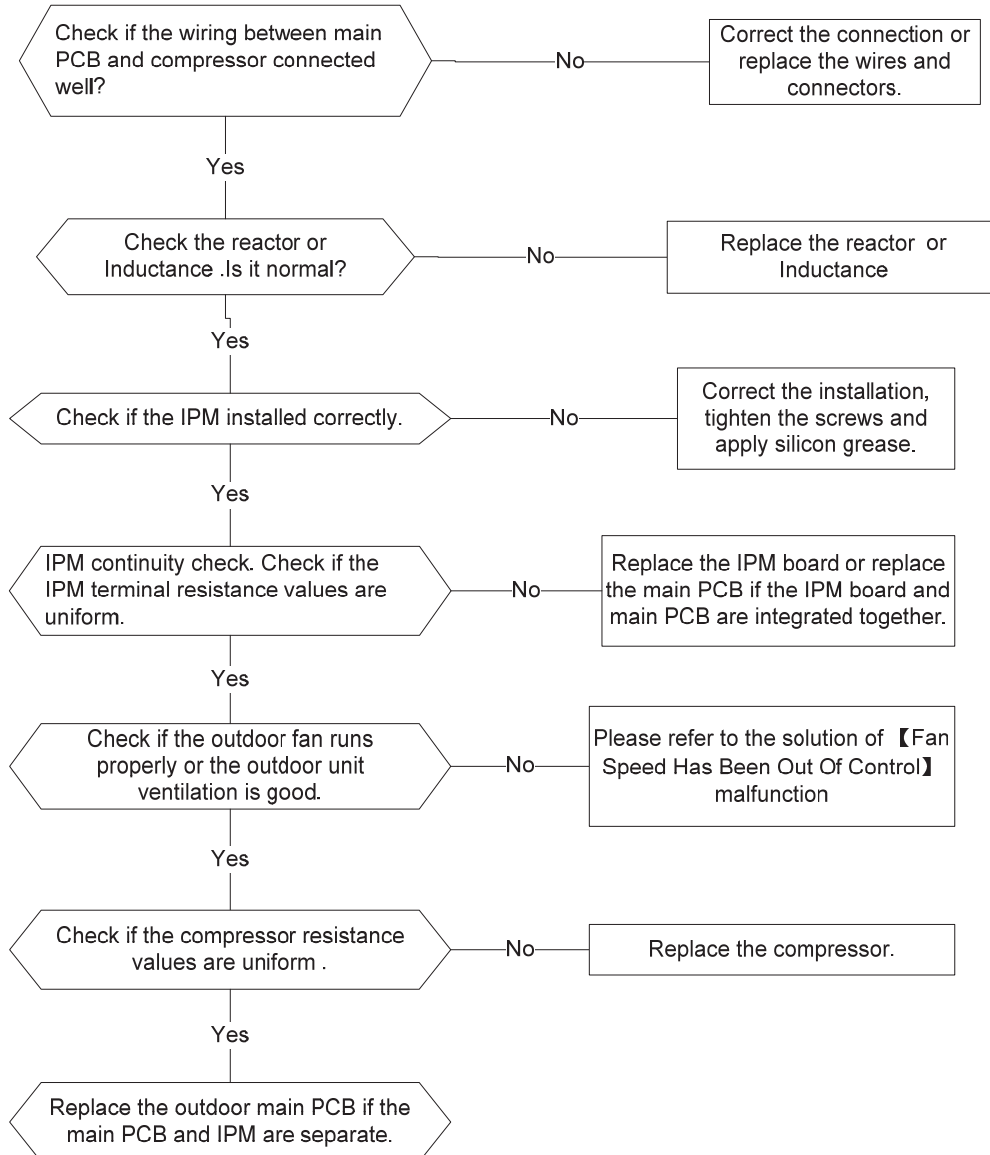

IPM continuity check

Turn off the power, let the large capacity electrolytic capacitors discharge completely, and dismount the IPM. Use a digital tester to measure the resistance between P and UVWN; UVW and N.

Digital tester		Normal resistance value	Digital tester		Normal resistance value
(+)Red	(-)Black		(+)Red	(-)Black	
P	N	∞ (Several MΩ)	U	N	∞ (Several MΩ)
	U		V		
	V		W		
	W		(+)Red		

For 30K~36K:

At first test the resistance between every two ports of U, V, W of IPM and P, N. If any result of them is 0 or close to 0, the IPM is defective. Otherwise, please follow the procedure below:

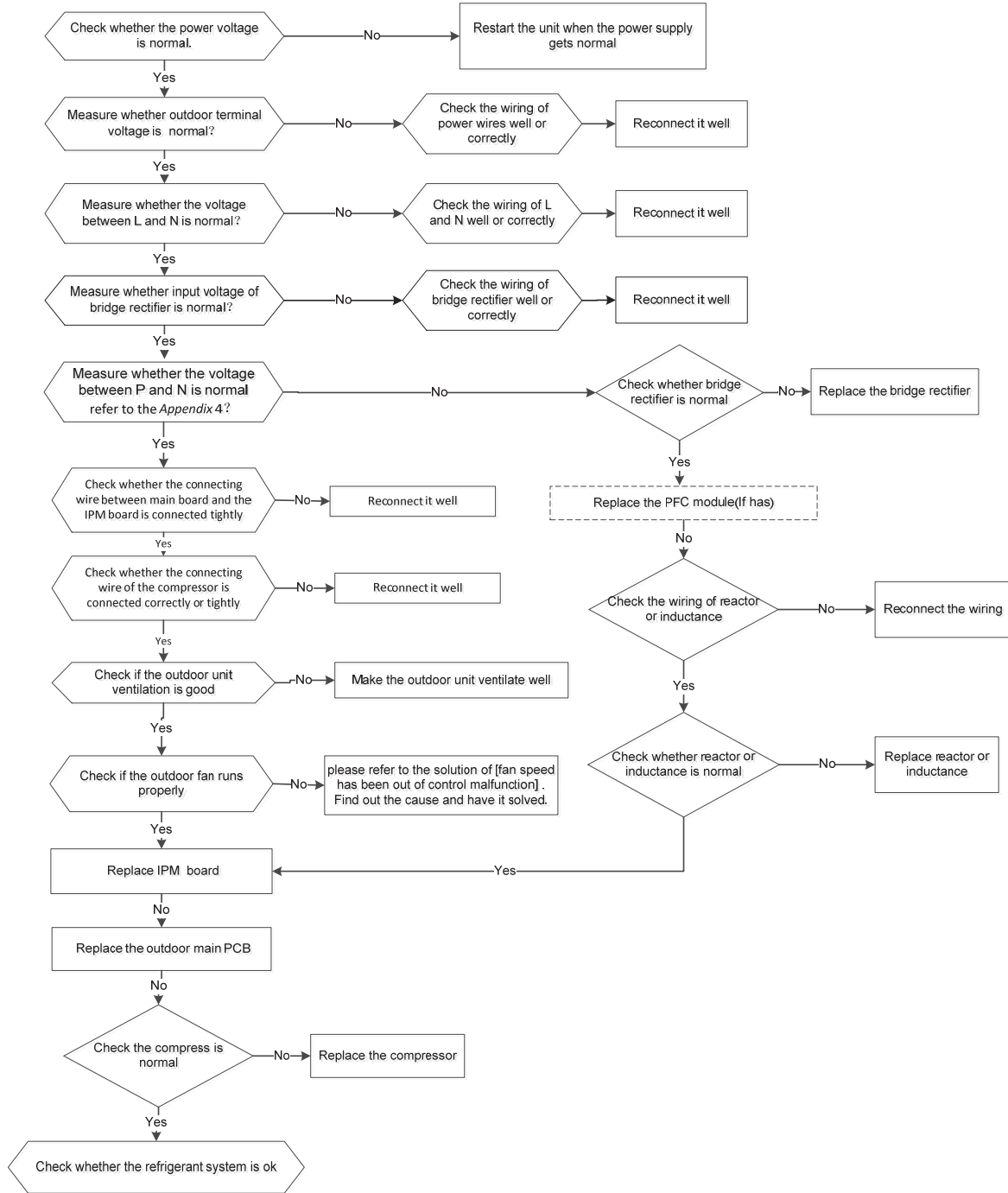

9.3.11 Low pressure protection diagnosis and solution (P6)

Error Code	P6
Malfunction decision conditions	When the pressure of system reach to a certain value, the low pressure protector will switch off. After the pressure resumes to normal, the protection code will disappear.
Supposed causes	<ul style="list-style-type: none"> ● Wiring mistake ● Pressure protector faulty ● Fan motor faulty ● PCB faulty ● System problems.

Trouble shooting:

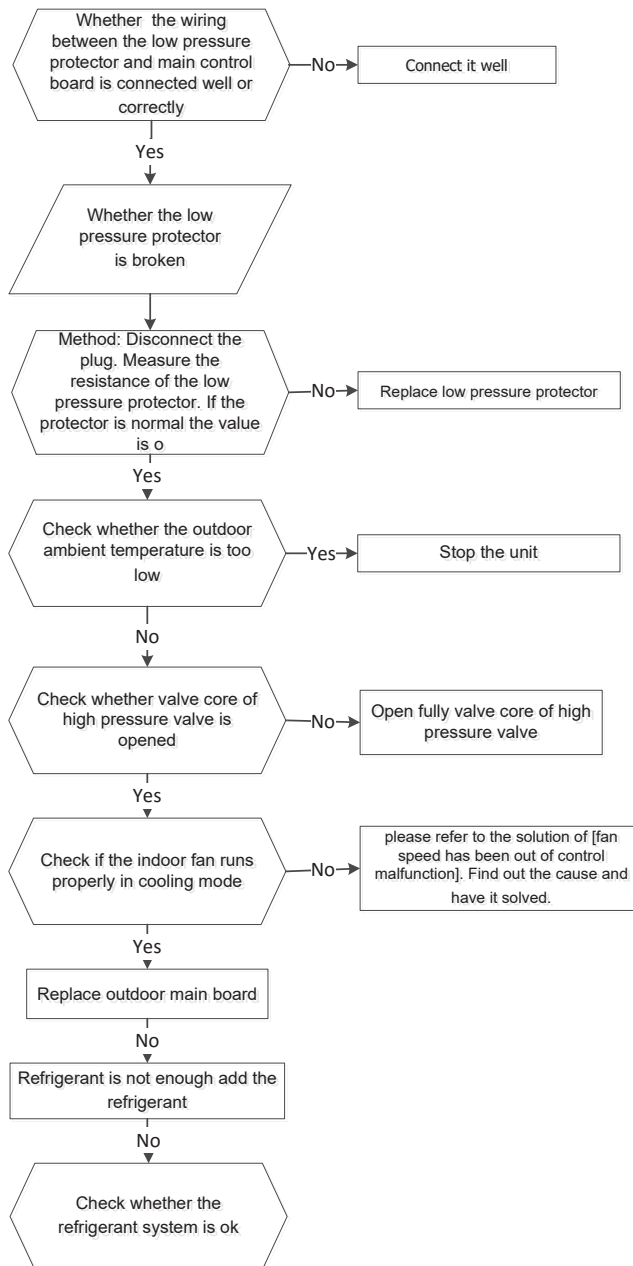

Main parts check

1. Temperature sensor checking

Disconnect the temperature sensor from PCB, measure the resistance value with a tester.

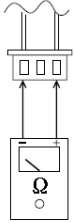

Tester

Temperature sensors.

Room temp.(T1) sensor,

Indoor coil temp.(T2) sensor,

Outdoor coil temp.(T3) sensor,

Outdoor ambient temp.(T4) sensor,

Compressor discharge temp.(TP) sensor.

Measure the resistance value of each winding by using the multi-meter.

Appendix 1 Temperature Sensor Resistance Value Table for T1,T2,T3,T4 (°C--K)

°C	°F	K Ohm	°C	°F	K Ohm	°C	°F	K Ohm	°C	°F	K Ohm
-20	-4	115.266	20	68	12.6431	60	140	2.35774	100	212	0.62973
-19	-2	108.146	21	70	12.0561	61	142	2.27249	101	214	0.61148
-18	0	101.517	22	72	11.5	62	144	2.19073	102	216	0.59386
-17	1	96.3423	23	73	10.9731	63	145	2.11241	103	217	0.57683
-16	3	89.5865	24	75	10.4736	64	147	2.03732	104	219	0.56038
-15	5	84.219	25	77	10	65	149	1.96532	105	221	0.54448
-14	7	79.311	26	79	9.55074	66	151	1.89627	106	223	0.52912
-13	9	74.536	27	81	9.12445	67	153	1.83003	107	225	0.51426
-12	10	70.1698	28	82	8.71983	68	154	1.76647	108	226	0.49989
-11	12	66.0898	29	84	8.33566	69	156	1.70547	109	228	0.486
-10	14	62.2756	30	86	7.97078	70	158	1.64691	110	230	0.47256
-9	16	58.7079	31	88	7.62411	71	160	1.59068	111	232	0.45957
-8	18	56.3694	32	90	7.29464	72	162	1.53668	112	234	0.44699
-7	19	52.2438	33	91	6.98142	73	163	1.48481	113	235	0.43482
-6	21	49.3161	34	93	6.68355	74	165	1.43498	114	237	0.42304
-5	23	46.5725	35	95	6.40021	75	167	1.38703	115	239	0.41164
-4	25	44	36	97	6.13059	76	169	1.34105	116	241	0.4006
-3	27	41.5878	37	99	5.87359	77	171	1.29078	117	243	0.38991
-2	28	39.8239	38	100	5.62961	78	172	1.25423	118	244	0.37956
-1	30	37.1988	39	102	5.39689	79	174	1.2133	119	246	0.36954
0	32	35.2024	40	104	5.17519	80	176	1.17393	120	248	0.35982
1	34	33.3269	41	106	4.96392	81	178	1.13604	121	250	0.35042
2	36	31.5635	42	108	4.76253	82	180	1.09958	122	252	0.3413
3	37	29.9058	43	109	4.5705	83	181	1.06448	123	253	0.33246
4	39	28.3459	44	111	4.38736	84	183	1.03069	124	255	0.3239
5	41	26.8778	45	113	4.21263	85	185	0.99815	125	257	0.31559
6	43	25.4954	46	115	4.04589	86	187	0.96681	126	259	0.30754
7	45	24.1932	47	117	3.88673	87	189	0.93662	127	261	0.29974
8	46	22.5662	48	118	3.73476	88	190	0.90753	128	262	0.29216
9	48	21.8094	49	120	3.58962	89	192	0.8795	129	264	0.28482
10	50	20.7184	50	122	3.45097	90	194	0.85248	130	266	0.2777
11	52	19.6891	51	124	3.31847	91	196	0.82643	131	268	0.27078
12	54	18.7177	52	126	3.19183	92	198	0.80132	132	270	0.26408
13	55	17.8005	53	127	3.07075	93	199	0.77709	133	271	0.25757
14	57	16.9341	54	129	2.95896	94	201	0.75373	134	273	0.25125
15	59	16.1156	55	131	2.84421	95	203	0.73119	135	275	0.24512
16	61	15.3418	56	133	2.73823	96	205	0.70944	136	277	0.23916
17	63	14.6181	57	135	2.63682	97	207	0.68844	137	279	0.23338
18	64	13.918	58	136	2.53973	98	208	0.66818	138	280	0.22776
19	66	13.2631	59	138	2.44677	99	210	0.64862	139	282	0.22231

Appendix 2 Temperature Sensor Resistance Value Table for TP (°C --K)

°C	°F	K Ohm	°C	°F	K Ohm	°C	°F	K Ohm	°C	°F	K Ohm
-20	-4	542.7	20	68	68.66	60	140	13.59	100	212	3.702
-19	-2	511.9	21	70	65.62	61	142	13.11	101	214	3.595
-18	0	483	22	72	62.73	62	144	12.65	102	216	3.492
-17	1	455.9	23	73	59.98	63	145	12.21	103	217	3.392
-16	3	430.5	24	75	57.37	64	147	11.79	104	219	3.296
-15	5	406.7	25	77	54.89	65	149	11.38	105	221	3.203
-14	7	384.3	26	79	52.53	66	151	10.99	106	223	3.113
-13	9	363.3	27	81	50.28	67	153	10.61	107	225	3.025
-12	10	343.6	28	82	48.14	68	154	10.25	108	226	2.941
-11	12	325.1	29	84	46.11	69	156	9.902	109	228	2.86
-10	14	307.7	30	86	44.17	70	158	9.569	110	230	2.781
-9	16	291.3	31	88	42.33	71	160	9.248	111	232	2.704
-8	18	275.9	32	90	40.57	72	162	8.94	112	234	2.63
-7	19	261.4	33	91	38.89	73	163	8.643	113	235	2.559
-6	21	247.8	34	93	37.3	74	165	8.358	114	237	2.489
-5	23	234.9	35	95	35.78	75	167	8.084	115	239	2.422
-4	25	222.8	36	97	34.32	76	169	7.82	116	241	2.357
-3	27	211.4	37	99	32.94	77	171	7.566	117	243	2.294
-2	28	200.7	38	100	31.62	78	172	7.321	118	244	2.233
-1	30	190.5	39	102	30.36	79	174	7.086	119	246	2.174
0	32	180.9	40	104	29.15	80	176	6.859	120	248	2.117
1	34	171.9	41	106	28	81	178	6.641	121	250	2.061
2	36	163.3	42	108	26.9	82	180	6.43	122	252	2.007
3	37	155.2	43	109	25.86	83	181	6.228	123	253	1.955
4	39	147.6	44	111	24.85	84	183	6.033	124	255	1.905
5	41	140.4	45	113	23.89	85	185	5.844	125	257	1.856
6	43	133.5	46	115	22.89	86	187	5.663	126	259	1.808
7	45	127.1	47	117	22.1	87	189	5.488	127	261	1.762
8	46	121	48	118	21.26	88	190	5.32	128	262	1.717
9	48	115.2	49	120	20.46	89	192	5.157	129	264	1.674
10	50	109.8	50	122	19.69	90	194	5	130	266	1.632
11	52	104.6	51	124	18.96	91	196	4.849			
12	54	99.69	52	126	18.26	92	198	4.703			
13	55	95.05	53	127	17.58	93	199	4.562			
14	57	90.66	54	129	16.94	94	201	4.426			
15	59	86.49	55	131	16.32	95	203	4.294			
16	61	82.54	56	133	15.73	96	205	4.167			
17	63	78.79	57	135	15.16	97	207	4.045			
18	64	75.24	58	136	14.62	98	208	3.927			
19	66	71.86	59	138	14.09	99	210	3.812			

Appendix 3:

$$\Delta T(^{\circ}\text{F}) = \frac{9\Delta T(^{\circ}\text{C})}{5}$$

$^{\circ}\text{C}$	$^{\circ}\text{F}$	$^{\circ}\text{C}$	$^{\circ}\text{F}$	$^{\circ}\text{C}$	$^{\circ}\text{F}$	$^{\circ}\text{C}$	$^{\circ}\text{F}$	$^{\circ}\text{C}$	$^{\circ}\text{F}$
-5	23	21	69.8	51	123.8	82	179.6	113	235.4
-4	24.8	22	71.6	52	125.6	83	181.4	114	237.2
-3	26.6	23	73.4	53	127.4	84	183.2	115	239
-2	28.4	24	75.2	54	129.2	85	185	116	240.8
-1	30.2	25	77	55	131	86	186.8	117	242.6
0	32	25.5	77.9	56	132.8	87	188.6	118	244.4
0.5	32.9	26	78.8	57	134.6	88	190.4	119	246.2
1	33.8	27	80.6	58	136.4	89	192.2	120	248
1.5	34.7	28	82.4	59	138.2	90	194	121	249.8
2	35.6	29	84.2	60	140	91	195.8	122	251.6
2.5	36.5	30	86	61	141.8	92	197.6	123	253.4
3	37.4	31	87.8	62	143.6	93	199.4	124	255.2
3.5	38.3	32	89.6	63	145.4	94	201.2	125	257
4	39.2	33	91.4	64	147.2	95	203	126	258.8
4.5	40.1	34	93.2	65	149	96	204.8	127	260.6
5	41	35	95	66	150.8	97	206.6	128	262.4
6	42.8	36	96.8	67	152.6	98	208.4	129	264.2
7	44.6	37	98.6	68	154.4	99	210.2	130	266
8	46.4	38	100.4	69	156.2	100	212	131	267.8
9	48.2	39	102.2	70	158	101	213.8	132	269.6
10	50	40	104	71	159.8	102	215.6	133	271.4
11	51.8	41	105.8	72	161.6	103	217.4	134	273.2
12	53.6	42	107.6	73	163.4	104	219.2	135	275
13	55.4	43	109.4	74	165.2	105	221	136	276.8
14	57.2	44	111.2	75	167	106	222.8	137	278.6
15	59	45	113	76	168.8	107	224.6	138	280.4
16	60.8	46	114.8	77	170.6	108	226.4	139	282.2
17	62.6	47	116.6	78	172.4	109	228.2	140	284
18	64.4	48	118.4	79	174.2	110	230	141	285.8
19	66.2	49	120.2	80	176	111	231.8	142	287.6
20	68	50	122	81	177.8	112	233.6	143	289.4

Appendix 4

Normal voltage of P and N			
208-240V(1-phase,3-phase)		380-420V(3-phase)	
In standby			
around 310VDC		around 530VDC	
In operation			
With passive PFC module	With partial active PFC module	With fully active PFC module	/
>200VDC	>310VDC	>370VDC	>450VDC

2.Compressor checking

Measure the resistance value of each winding by using the tester.

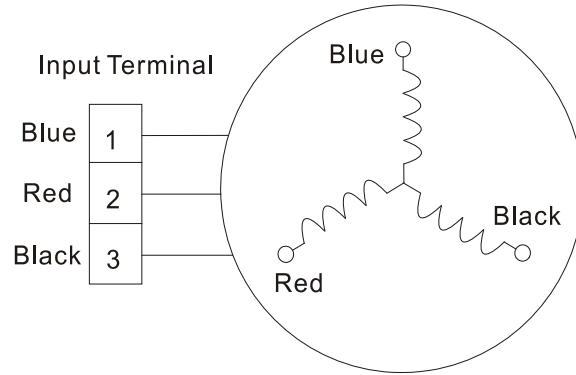

Position	Resistance Value			
	ASN98D22UFZ	ASM135D23UFZ	ATF235D22UMT	ATF250D22UMT
Blue - Red	1.57 Ω	1.75 Ω	0.75 Ω	0.75 Ω
Blue - Black				
Red - Blue				



4: Fan Motor

Measure the resistance value of each winding by using the tester.

Model		YKT-32-6-202L	YKT-32-6-3L	YKT-48-6-206	YKT-63-6-200L
Brand		Tongde	Welling	Welling	Welling
Black – Red Main	Ω	86	213	152	88.5
Blue –Black AUX	Ω	64	156	142	138

5: Pressure On Service Port

Cooling chart:

°F(°C)	ODT		75	85	95	105	115
	IDT		(23.89)	(29.44)	(35)	(40.56)	(46.11)
BAR	70/59		8.2	7.8	8.1	8.6	10.1
BAR	75/63		8.6	8.3	8.7	9.1	10.7
BAR	80/67		9.3	8.9	9.1	9.6	11.2

°F(°C)	ODT		75	85	95	105	115
	IDT		(23.89)	(29.44)	(35)	(40.56)	(46.11)
PSI	70/59		119	113	117	125	147
PSI	75/63		124	120	126	132	155
PSI	80/67		135	129	132	140	162

°F(°C)	ODT		75	85	95	105	115
	IDT		(23.89)	(29.44)	(35)	(40.56)	(46.11)
MPA	70/59		0.82	0.78	0.81	0.86	1.01
MPA	75/63		0.86	0.83	0.87	0.91	1.07
MPA	80/67		0.93	0.89	0.91	0.96	1.12

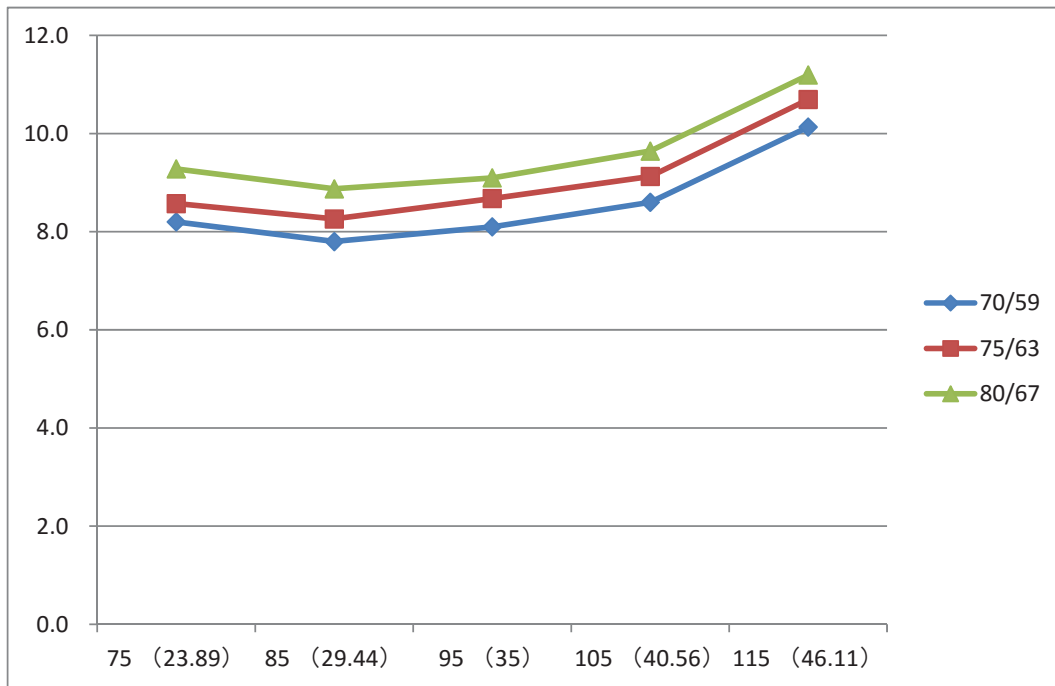

Heating Chart:

°F (°C)	ODT IDT	57/53	47/43	37/33	27/23	17/13
		(13.89/11.67)	(8.33/6.11)	(2.78/0.56)	(-2.78/-5)	(-8.33/-10.56)
BAR	55	30.3	28.5	25.3	22.8	20.8
BAR	65	32.5	30.0	26.6	25.4	23.3
BAR	75	33.8	31.5	27.8	26.3	24.9

°F (°C)	ODT IDT	57/53	47/43	37/33	27/23 (-	17/13
		(13.89/11.67)	(8.33/6.11)	(2.78/0.56)	2.78/-5)	(-8.33/-10.56)
PSI	55	439	413	367	330	302
PSI	65	471	435	386	368	339
PSI	75	489	457	403	381	362

°F (°C)	ODT IDT	57/53	47/43	37/33	27/23 (-	17/13
		(13.89/11.67)	(8.33/6.11)	(2.78/0.56)	2.78/-5)	(-8.33/-10.56)
MPA	55	3.03	2.85	2.53	2.28	2.08
MPA	65	3.25	3.00	2.66	2.54	2.33
MPA	75	3.38	3.15	2.78	2.63	2.49

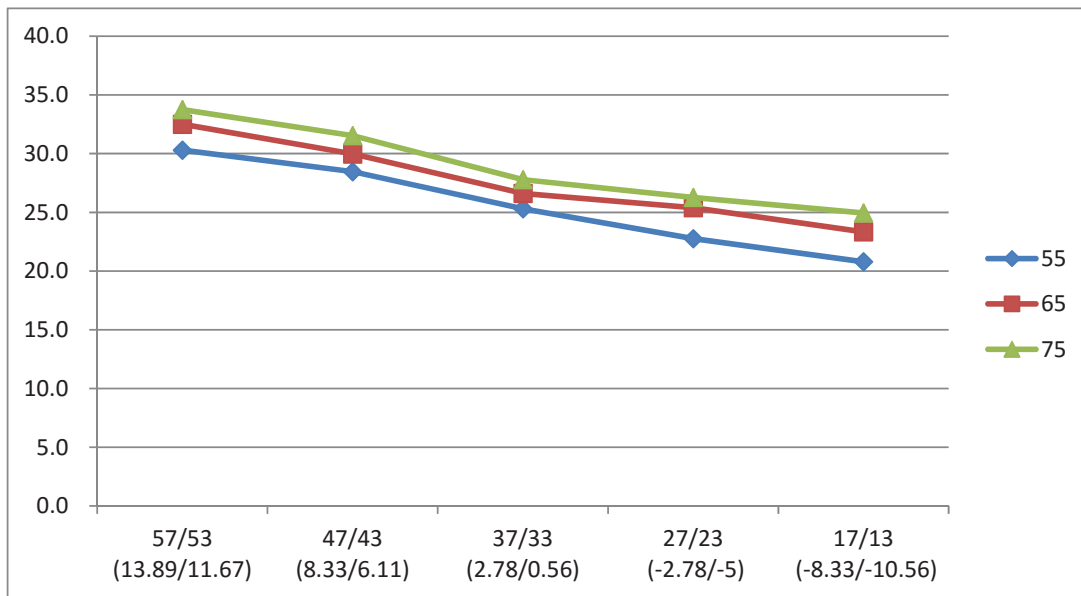

10 Disassembly Instructions

Note: This part is for reference, the photos may have slight difference with your product.

10.1 Indoor unit

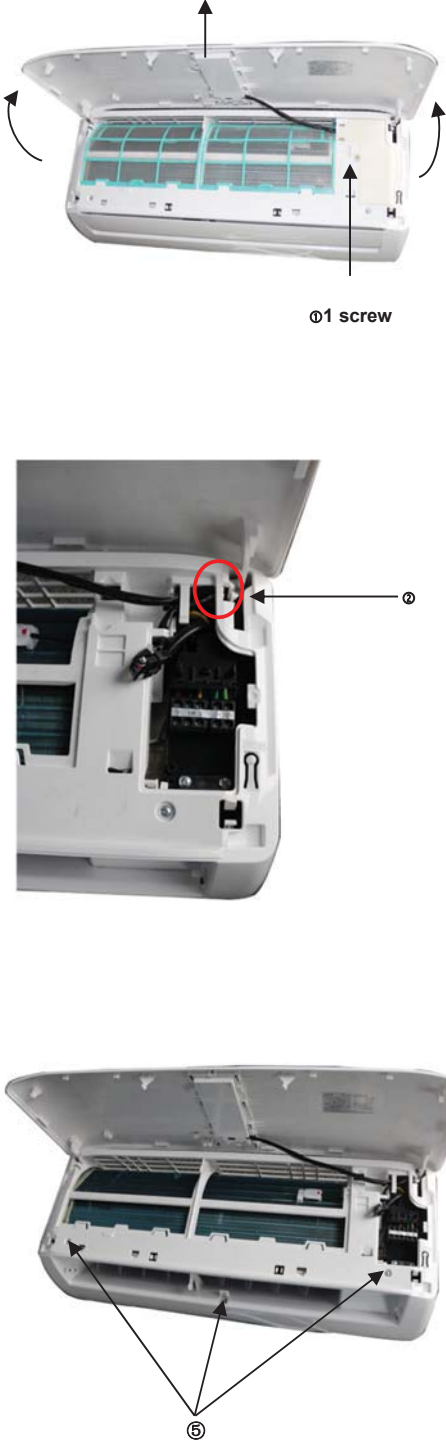
No.	Parts name	Procedures	Remarks
1	Front panel	<p>How to remove the front panel.</p> <p>1) Pull the below side of the panel toward you and remove screw of the cover.</p> <p>2) Release the connector of the display ass'y.</p> <p>3) Release the two clips and then remove the panel.</p> <p>4) Remove the filter and the horizontal louver.</p> <p>5) Remove the three screws and then remove the panel ass'y.</p>	

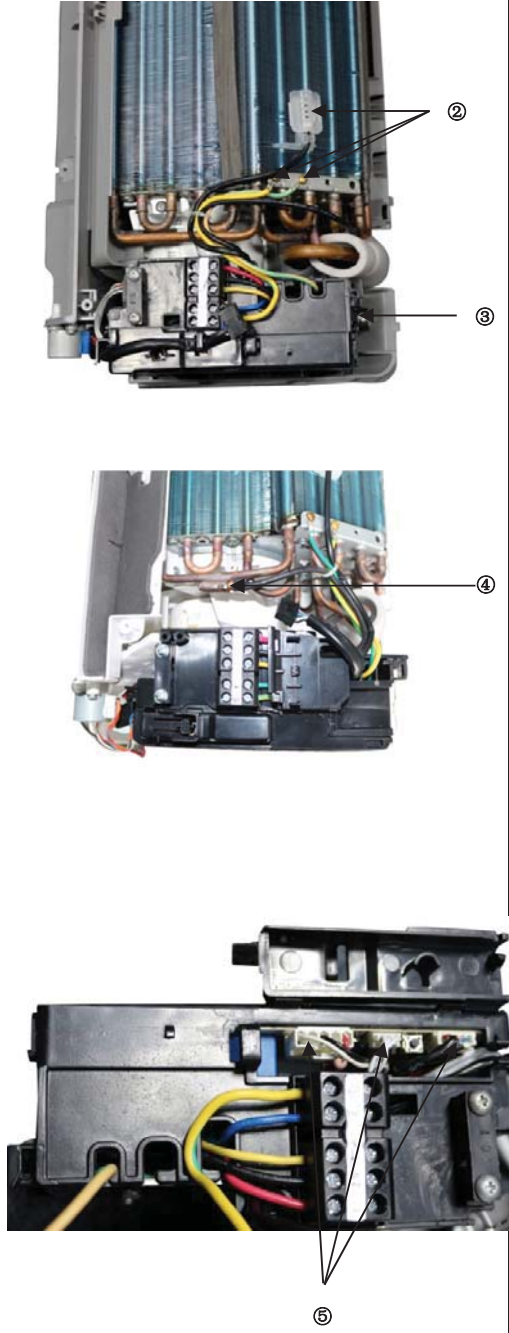
2	Electrical parts	<p>How to remove the electrical parts.</p> <p>1) Remove the front panel from procedure 1.</p> <p>2) Pull out the room temp. sensor (T1). Remove the two screws for the ground connection.</p> <p>3) Remove the fixing screw.</p> <p>4) Pull out the coil temp. sensor.</p> <p>5) From the side direction, open the electronic control box cover fixing by clips. Pull out the fan motor connector and swing motor connector. Then remove the electronic control box.</p>	
---	------------------	--	---

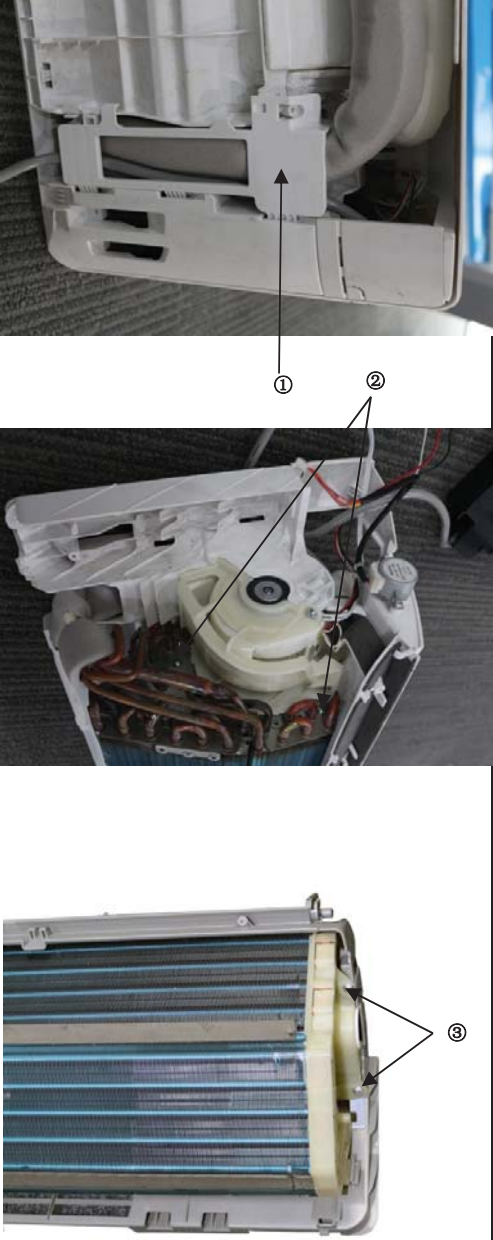
3	Evaporator	<p>How to remove the evaporator.</p> <ol style="list-style-type: none">1) After remove the electrical parts from procedure 2, disassemble the pipe holder at the rear side of the unit.2) Remove the screw on the evaporator at the fixed plate.3) Remove the two screws on the evaporator at the base bearing side.4) Then pull out the evaporator.	
---	------------	---	---

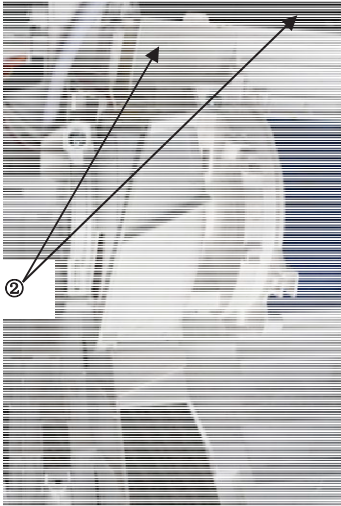
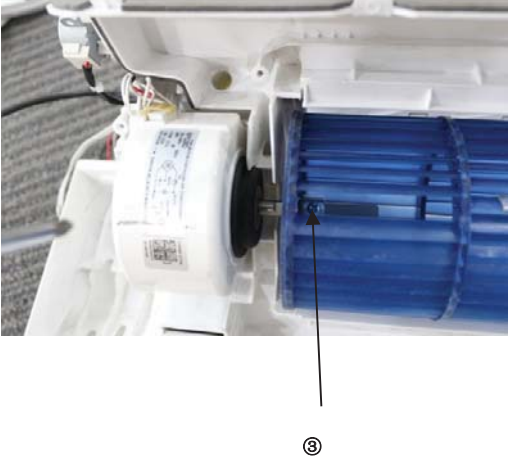
4	Fan motor and Fan	<p>How to remove the fan motor.</p> <p>1) Remove the front panel, electrical parts and evaporator following procedure 1-3.</p> <p>2) Remove the two screws and remove the fixing board of fan motor.</p> <p>3) Remove the fixing screw .</p> <p>4) Pull out the fan motor and fan ass'y from the side direction.</p>	 
---	-------------------	--	---

10.2 Outdoor unit

Note: This part is for reference, the photos may have slight difference with your machine. WYS009AMFI17RL, WYS012AMFI17RL, WYS009GMFI17RL, WYS012GMFI17RL, WYS009AMFI22RL, WYS009GMFI22RL

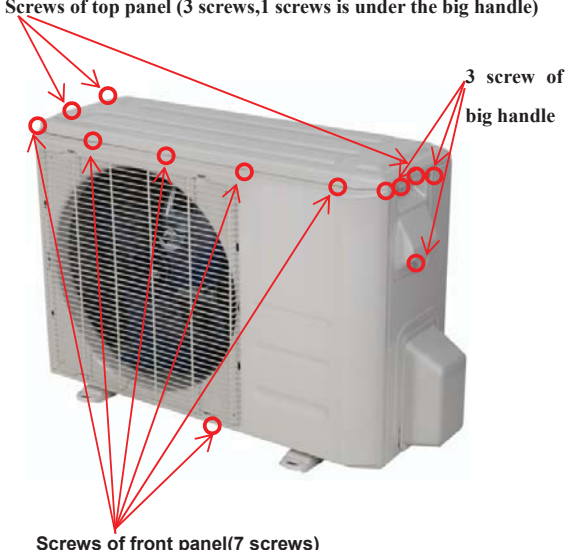
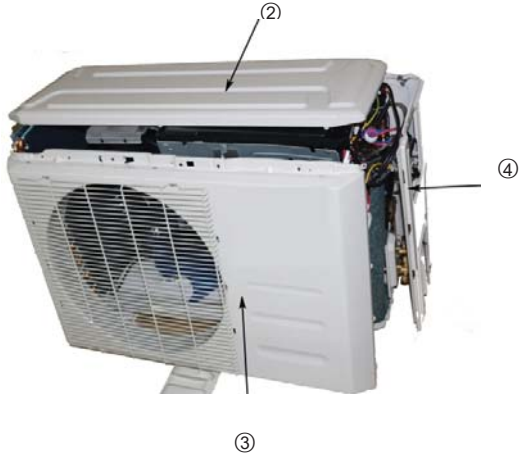
No.	Part name	Procedures	Remarks
1	Panel plate	<p>How to remove the panel plate.</p> <p>1) Stop operation of the air conditioner and turn "OFF" the power breaker.</p> <p>2) Remove the big handle first, then remove the top cover (3 screws)</p> <p>3) Remove the screws of front panel(7 screws)</p> <p>(4) Remove the screws of the right side panel(11 screws)</p>	 <p>Screws of top panel (3 screws, 1 screw is under the big handle)</p> <p>3 screw of big handle</p> <p>Screws of front panel(7 screws)</p>  <p>②</p> <p>③</p> <p>④</p>

2 Fan ass' y

How to remove the fan ass' y.

1) After remove the panel plate following procedure 1.

2) Remove the nut fixing the fan, and remove the fan.

3) After remove the top cover .Unfix the hooks and then open the electronic control box cover.

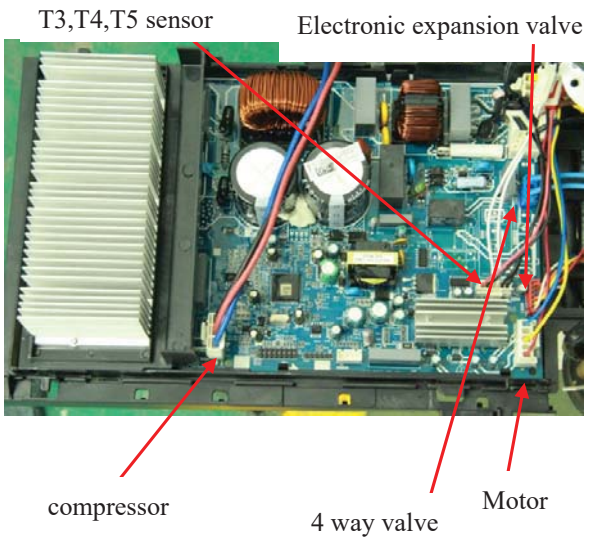
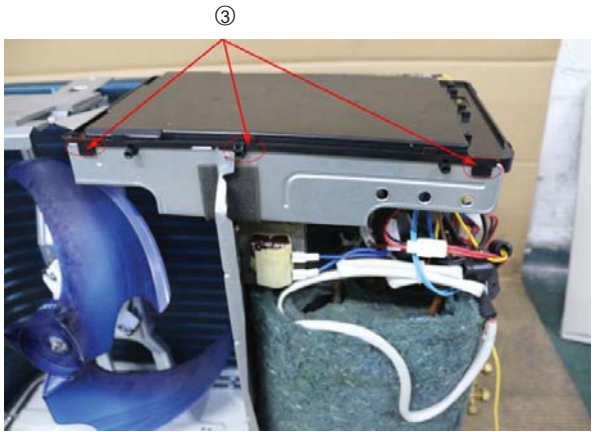
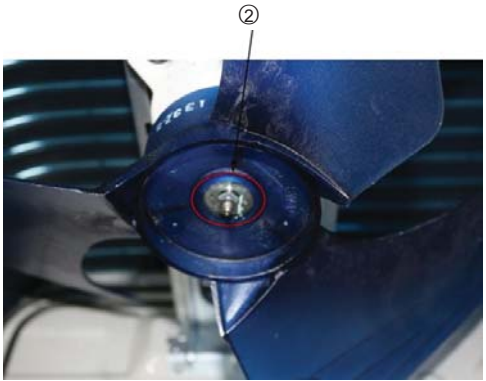

4) Disconnect the connector for fan motor from the electronic control board.

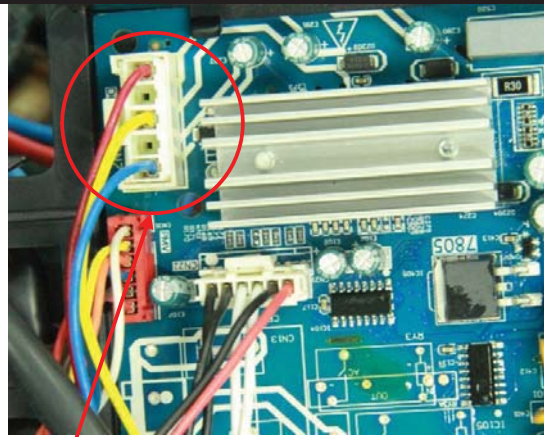

④

5) Remove the four fixing screws of the fan motor, then remove the motor.

⑤

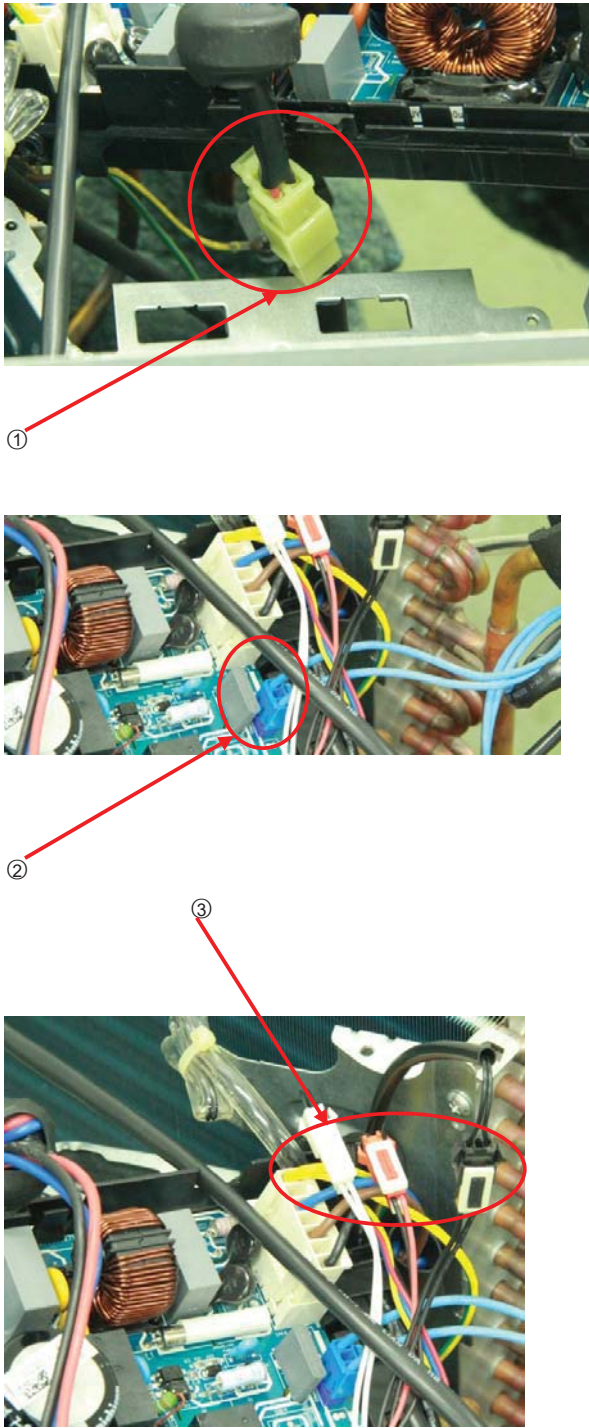

<p>3</p>	<p>Electrical parts</p>	<p>How to remove the electrical parts.</p> <p>1) After finish work of item 1 and item 2, remove the connector for the compressor .</p> <p>2) Pull out the two blue wires connected with the four way valve.</p> <p>3) Pull out connectors of the condenser coil temp. sensor(T3),outdoor ambient temp. sensor(T4) and discharge temp. sensor(TP).</p>	
----------	-------------------------	---	---

4) Disconnect the electronic expansion valve wire from the control board

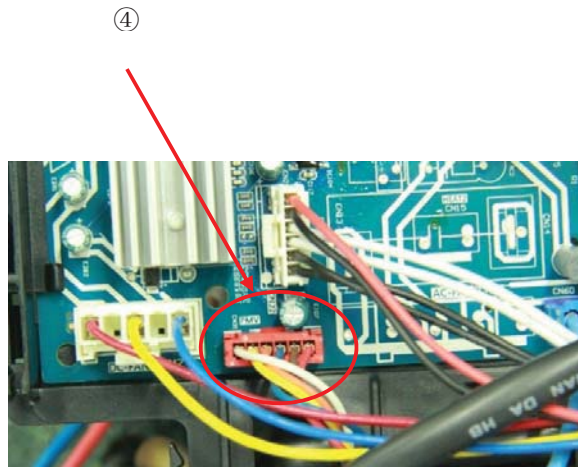



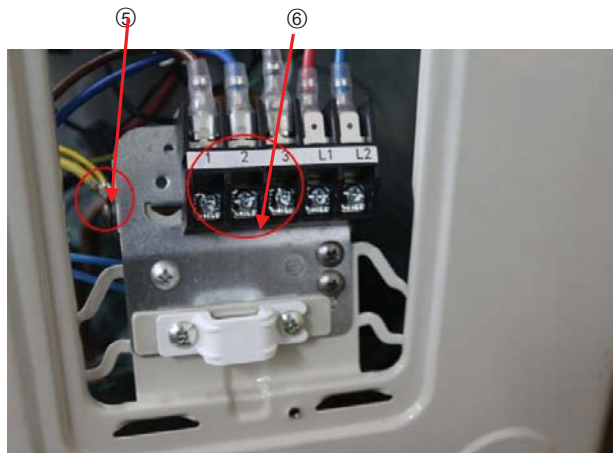

5) Remove the ground wires .

6) Remove the wires(1,2,3).

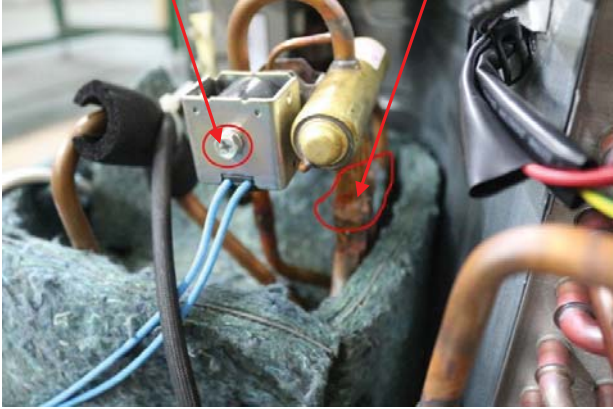
7) Then remove the electronic control box.

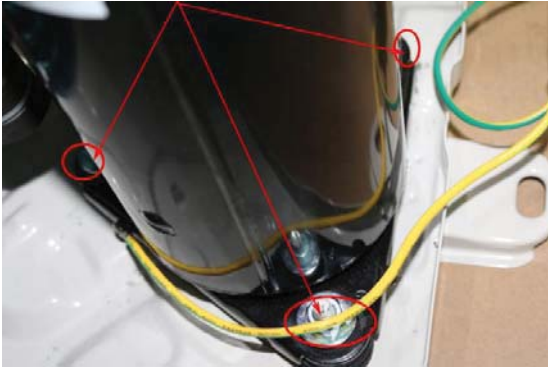

4	Four-way valve	<p>How to remove the four-way valve.</p> <ol style="list-style-type: none"> 1) Perform work of item 1,3. 2) Recover refrigerant from the refrigerant circuit. 3) Remove the screw of the coil and then remove the coil. 4) Detach the welded parts of four-way valve and pipe. 5) Then the four-way valve assembly can be removed 	<p>The picture of four-way valve may be different from the one on your side. ④</p> 
5	Compressor	<p>How to remove the compressor.</p> <ol style="list-style-type: none"> 1) After perform work of item 1,3. Recover refrigerant from the refrigerant circuit. 2) Remove the discharge pipe and suction pipe with a burner. 3) Remove the hex nuts and washers fixing the compressor on bottom plate. 4) Lift the compressor from the base pan assembly. 	<p>②</p>  <p>③</p> 

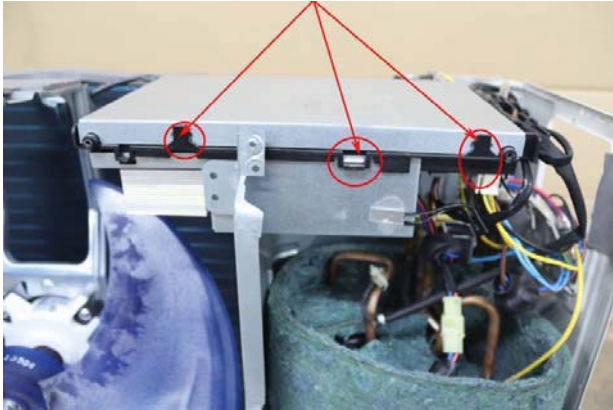
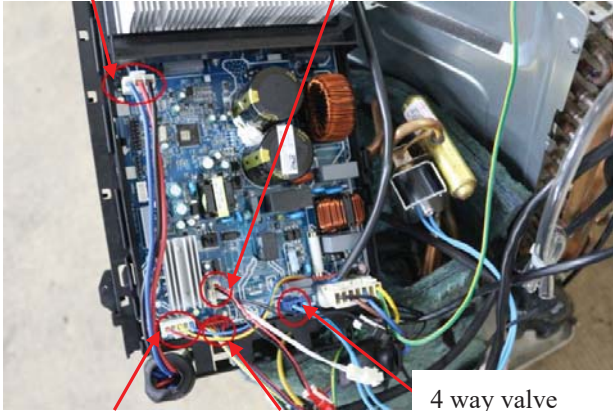
2	Fan ass'y	<p>How to remove the fan ass'y.</p> <p>1) After remove the panel plate following procedure 1, remove the hex nut fixing the fan and then remove the fan.</p> <p>2) Unfix the hooks and then open the electronic control box cover.</p>	 <p>①</p>  <p>②</p> <p>compressor T3,T4,T5 sensor</p>  <p>Motor Electronic expansion valve 4 way valve</p>
---	-----------	--	--

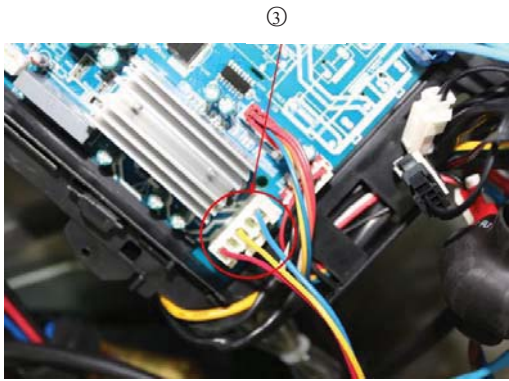
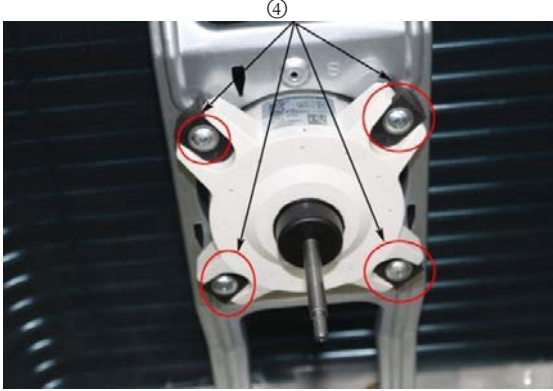
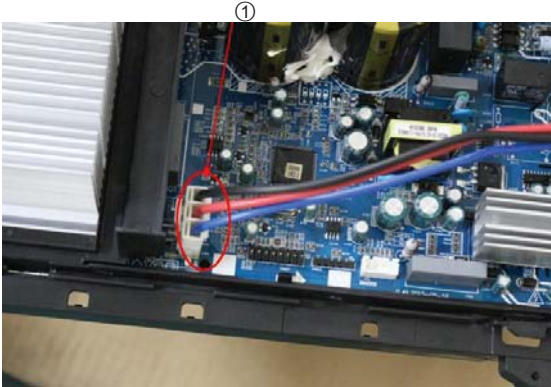
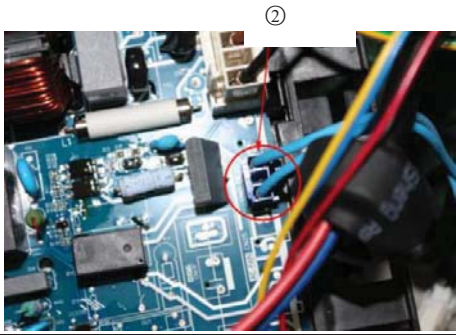
		<p>3) Disconnect the connector for fan motor from the electronic control board.</p> <p>4) Remove the four fixing screws of the fan motor. Then remove the fan motor.</p>	 
3	Electrical parts	<p>How to remove the electrical parts.</p> <p>1) After finish work of item 1 and item 2, remove the connectors for the compressor.</p> <p>2) Pull out the two blue wires connected with the four way valve.</p>	 

3) Pull out connectors of the condenser coil temp. sensor(T3), outdoor ambient temp. sensor(T4) and discharge temp. sensor(TP).

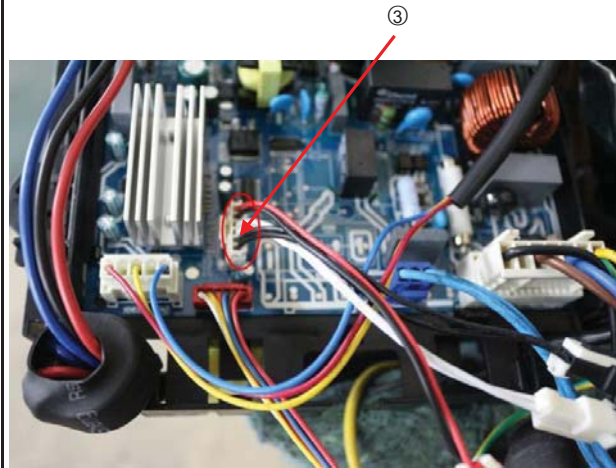

4) disconnect the electronic expansion valve wire

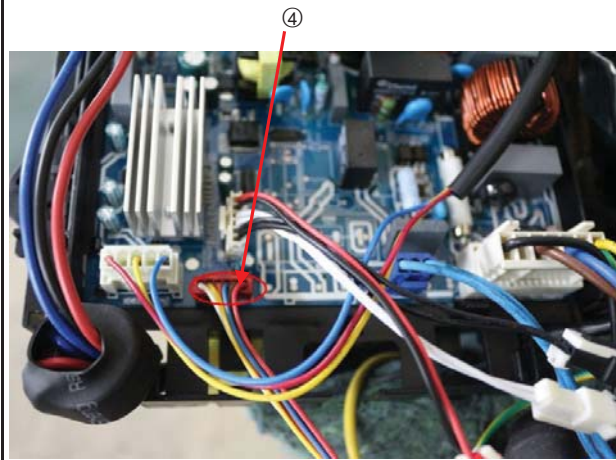

5) Remove the grounding screw.

6) Remove the Wires (1,2,3). Then remove the electronic control box.

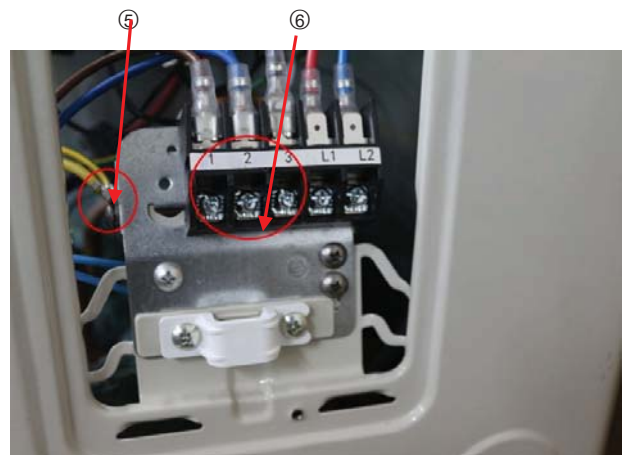

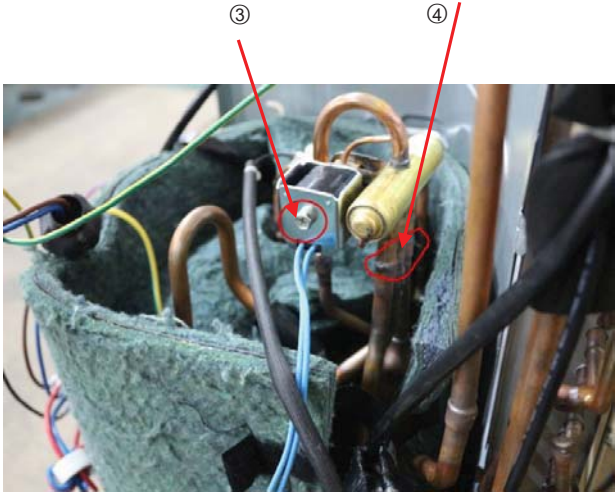
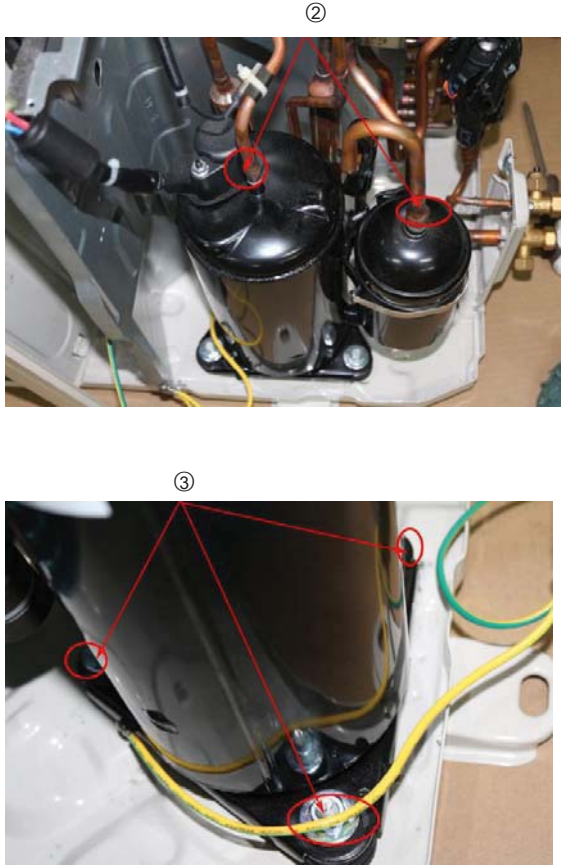

4	Four-way valve	<p>How to remove the four-way valve.</p> <ol style="list-style-type: none"> 1) Perform work of item 1,3. 2) Recover refrigerant from the refrigerant circuit. 3) Remove the screw of the coil and then remove the coil. 4) Detach the welded parts of four-way valve and pipe. 5) Then the four-way valve ass'y can be removed 	<p>The picture of four-way valve may be different from the one on your side.</p> 
5	Compressor	<p>How to remove the compressor.</p> <ol style="list-style-type: none"> 1) After perform work of item 1,3. Recover refrigerant from the refrigerant circuit. 2) Remove the discharge pipe and suction pipe with a burner. 3) Remove the hex nuts and washers fixing the compressor on bottom plate. 4) Lift the compressor from the base pan assembly. 	

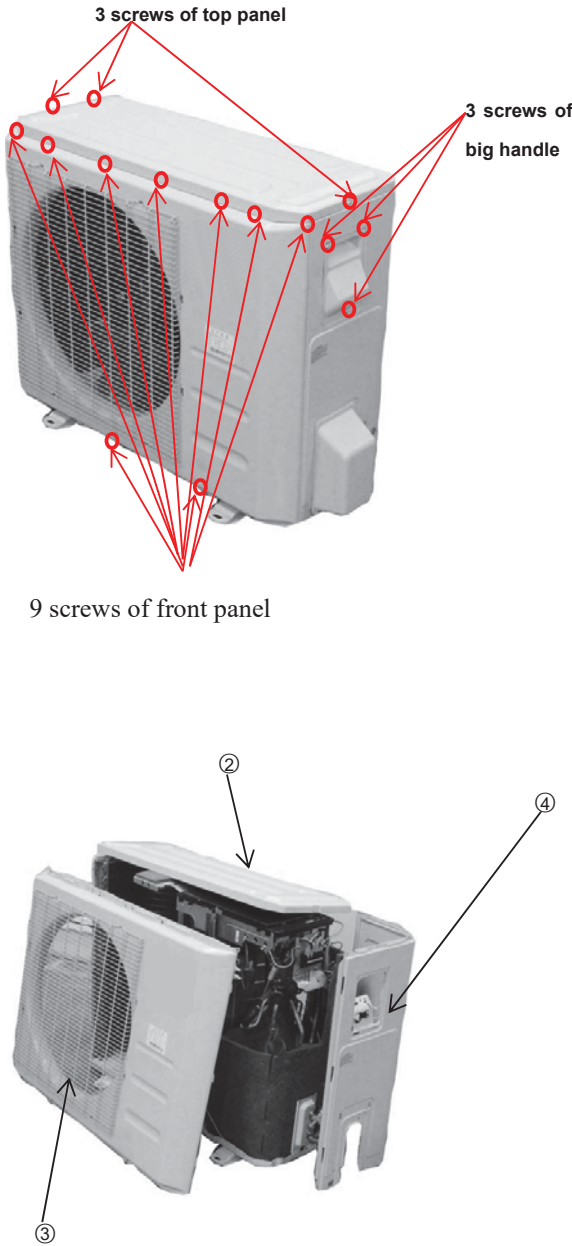
WYS024FMFI17RL, WYS018GMFI22RL

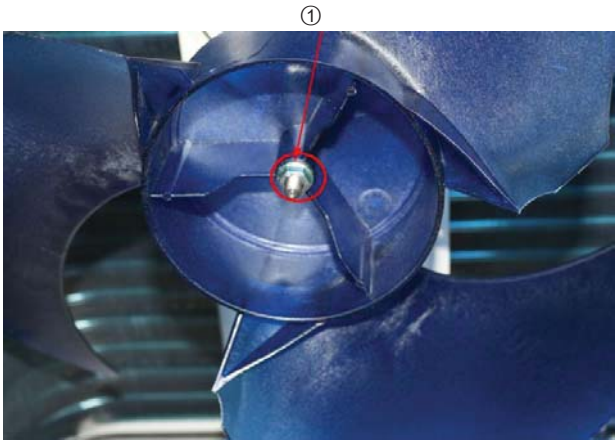
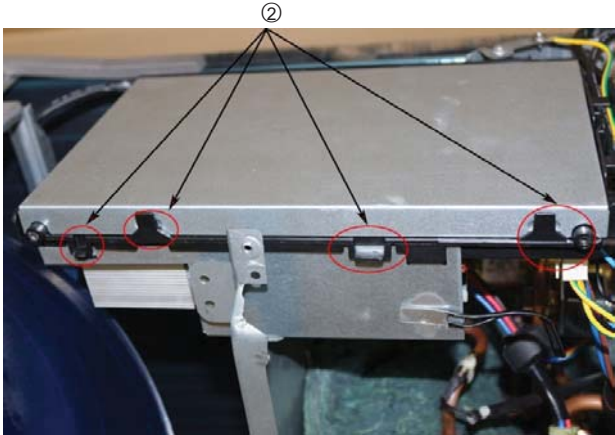
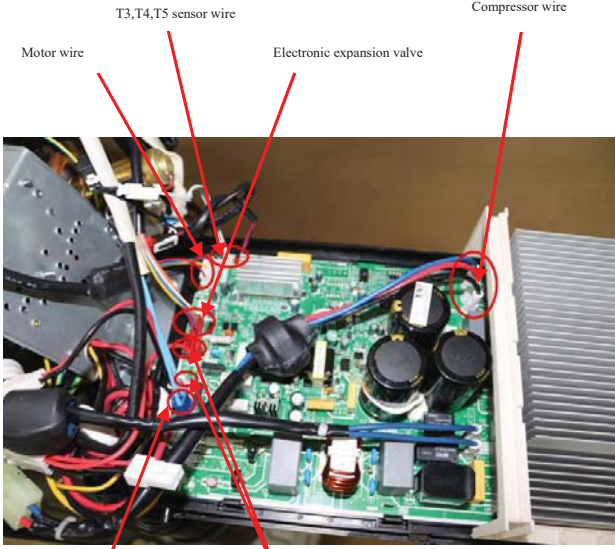
No.	Part name	Procedures	Remarks
	Panel plate	<p>How to remove the panel plate.</p> <p>1) Stop operation of the air conditioner and turn "OFF" the power breaker.</p> <p>2) Remove the top panel(3 screws).</p> <p>3) Remove the screws of front panel(9 screws)</p> <p>4) Remove the screws of the right side panel(8 screws)</p>	 <p>3 screws of top panel</p> <p>3 screws of big handle</p> <p>9 screws of front panel</p> <p>②</p> <p>③</p> <p>④</p>

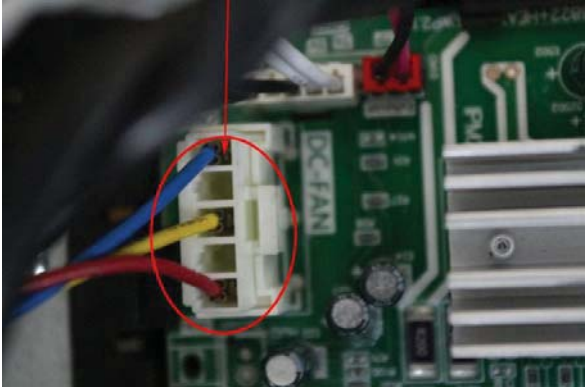
2	Fan ass' y	<p>How to remove the fan ass' y.</p> <p>1) After remove the panel plate following procedure 1, remove the hex nut fixing the fan and then remove the fan.</p> <p>2) After remove the top cover . Unfix the hooks and then open the electronic control box cover.</p>	   <p>T3,T4,T5 sensor wire</p> <p>Compressor wire</p> <p>Motor wire</p> <p>Electronic expansion valve</p> <p>4 way valve wire</p> <p>Electric pipe heater and Crankcase electric heater</p>
---	------------	--	--

		<p>3) Disconnect the connector for fan motor from the electronic control board.</p> <p>4) Remove the four fixing screws of the fan motor.</p> <p>Then remove the fan motor.</p>	<p>③</p>  <p>④</p> 
3	Electrical parts	<p>How to remove the electrical parts.</p> <p>1) After finish work of item 1 and item 2, remove the connectors for the compressor and reactor.</p>	<p>①</p> 

2) Pull out the two blue wires connected with the four way valve.

②

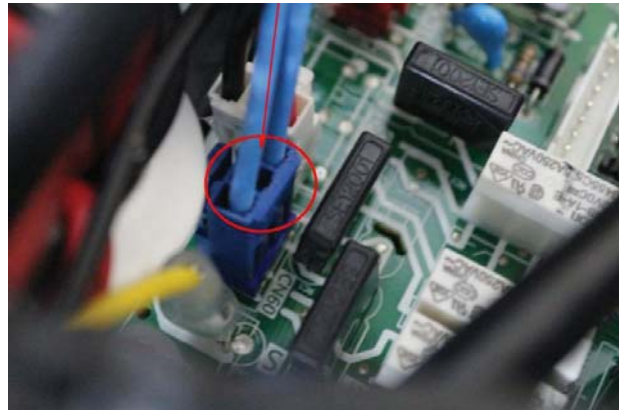

3) Pull out connectors of the condenser coil temp. sensor(T3), outdoor ambient temp. sensor(T4) and discharge temp. sensor(TP).

③

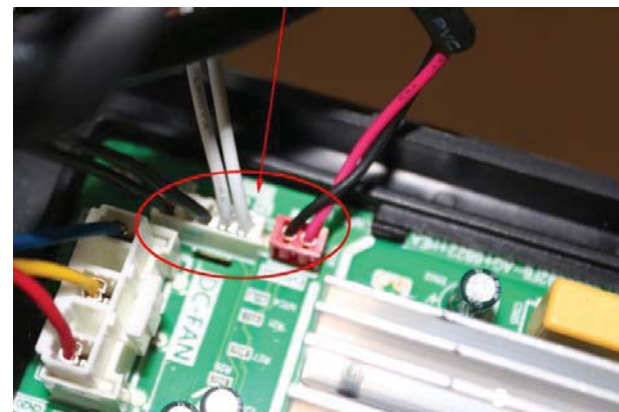

4) disconnect the electronic expansion valve wire

④

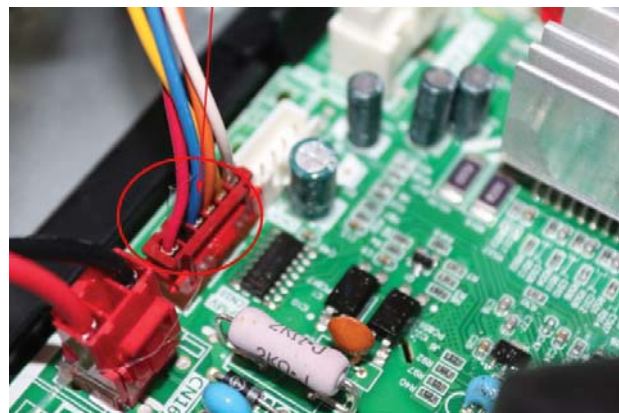

5) remove the electric heaters.

⑤

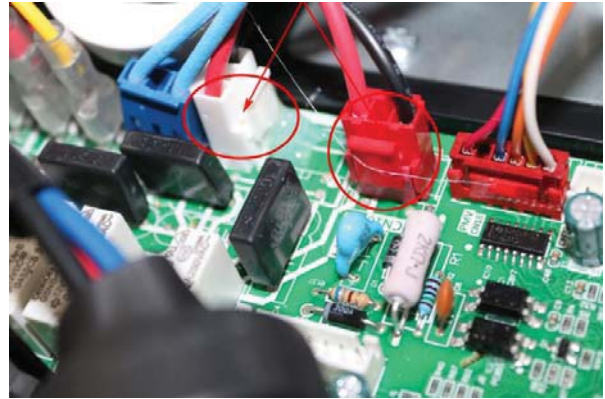

6) Remove the grounding screw.

7) Remove the Wires (1,2,3 or L1,L2,S).Then remove the electronic control box.

⑥

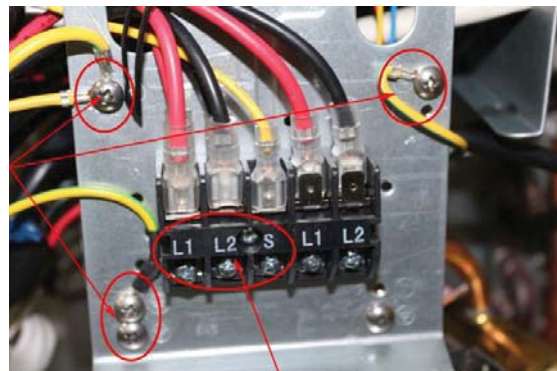

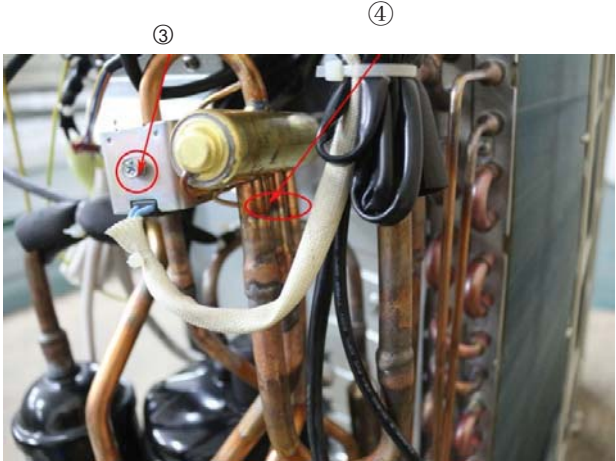
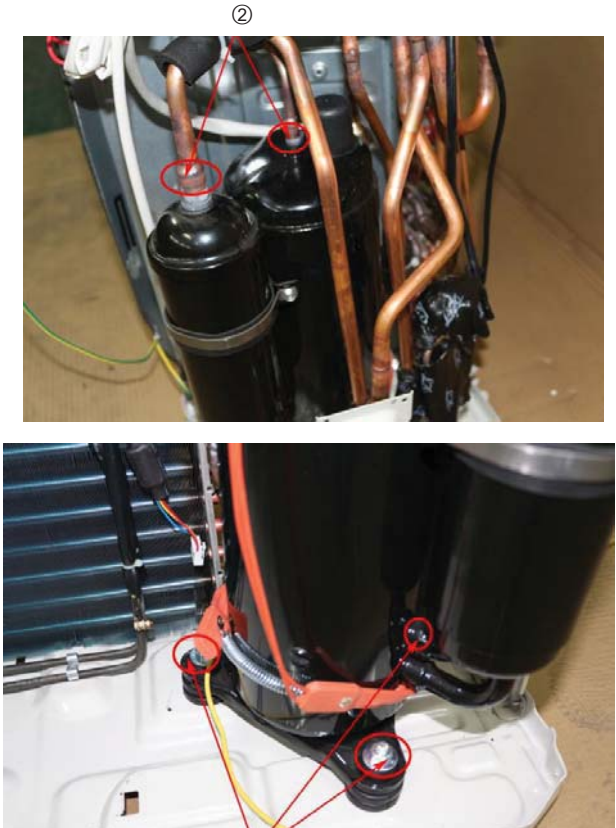

⑦

4	Four-way valve	<p>How to remove the four-way valve.</p> <ol style="list-style-type: none"> 1) Perform work of item 1,3. 2) Recover refrigerant from the refrigerant circuit. 3) Remove the screw of the coil and then remove the coil. 4) Detach the welded parts of four-way valve and pipe. 6) Then the four-way valve assembly can be removed 	<p>The picture of four-way valve may be different from the one on your side.</p> 
5	Compressor	<p>How to remove the compressor.</p> <ol style="list-style-type: none"> 1) After perform work of item 1,3. Recover refrigerant from the refrigerant circuit 2) Remove the discharge pipe and suction pipe with a burner. 3) Remove the hex nuts and washers fixing the compressor on bottom plate. 4) Lift the compressor from the base pan assembly. 	

			③
--	--	--	---

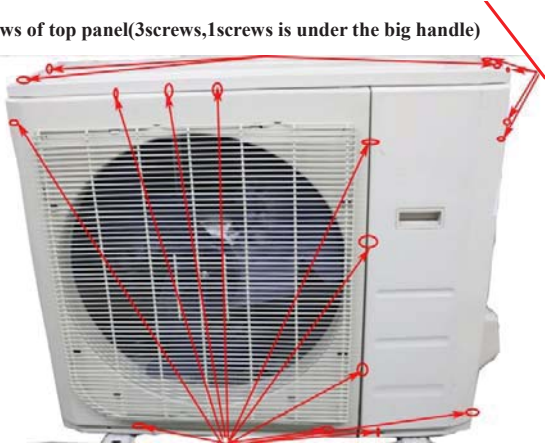
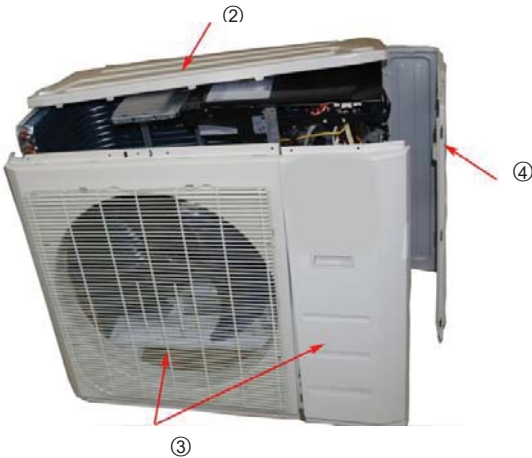
WYS030GMFI17RL, WYS036GMFI17RL, WYS24GMFI22RL

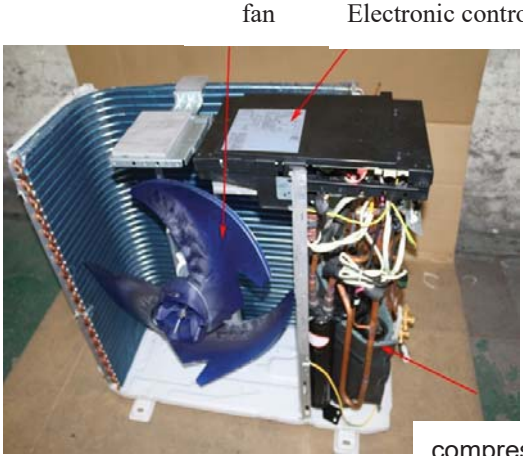
No.	Part name	Procedures	Remarks
1	Panel plate	<p>How to remove the panel plate.</p> <p>1) Stop operation of the air conditioner and turn "OFF" the power breaker.</p> <p>2) Remove the big handle first, then remove the top cover (7 screws)</p> <p>3) Remove the screws of front panel (11 screws)</p> <p>(4) Remove the screws of the right side panel (13 screws)</p>	<p>4 screws of big handle</p> <p>Screws of top panel (3 screws, 1 screw is under the big handle)</p>  <p>Screws of front panel (11 screws)</p> 

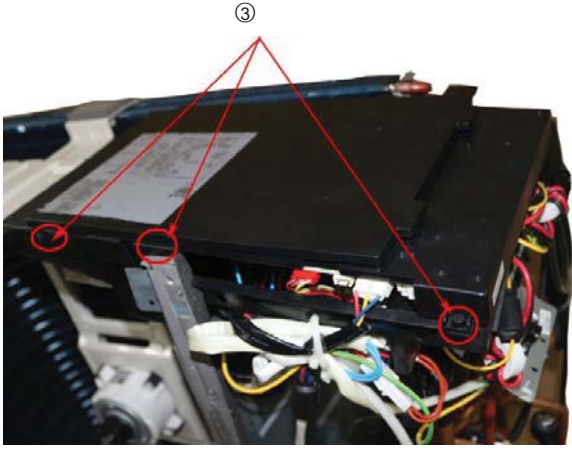
2	Fan ass'y	<p>How to remove the fan ass'y.</p> <p>1) After remove the panel plate following procedure 1</p> <p>2) Remove the nut fixing the fan, and remove the fan.</p> <p>3) Unfix the hooks and remove the screws, then open the electronic control box cover.</p>	 <p>fan Electronic control box</p>  <p>②</p>  <p>③</p> <p>compressor</p>
---	-----------	--	--

T3,T4,T5,sensor Pressure switch Compressor wire

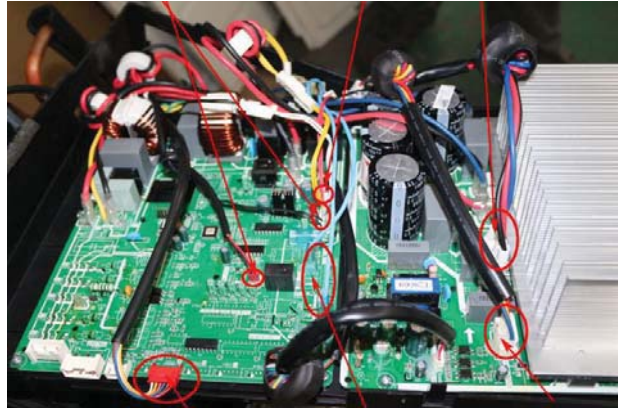

Electronic expansion 4 way valve Motor wire

4) Disconnect the connector for fan motor from the electronic control board.

④

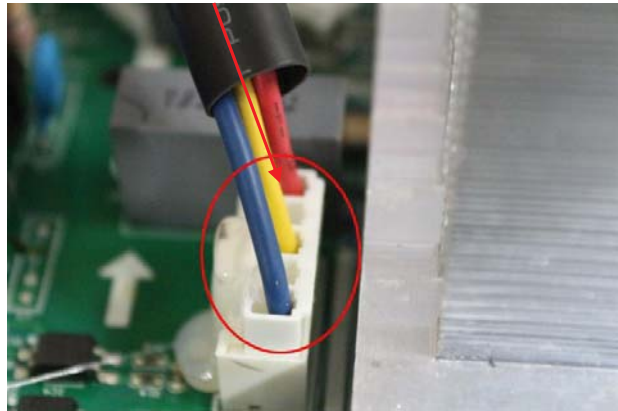

5) Remove the four fixing screws of the fan motor, then remove the motor.

⑤

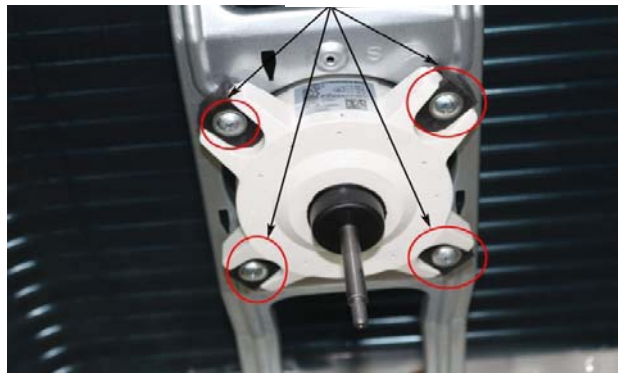

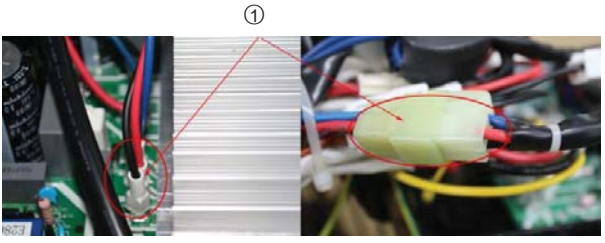
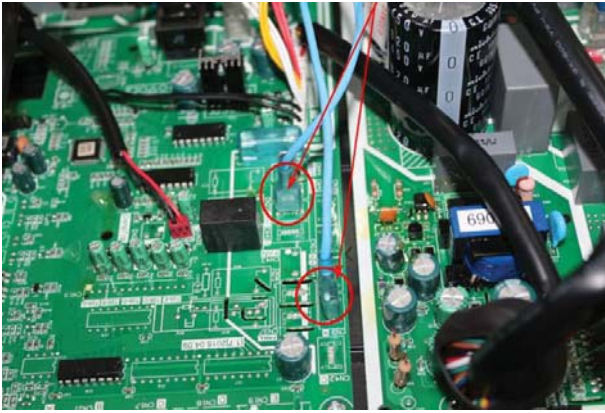
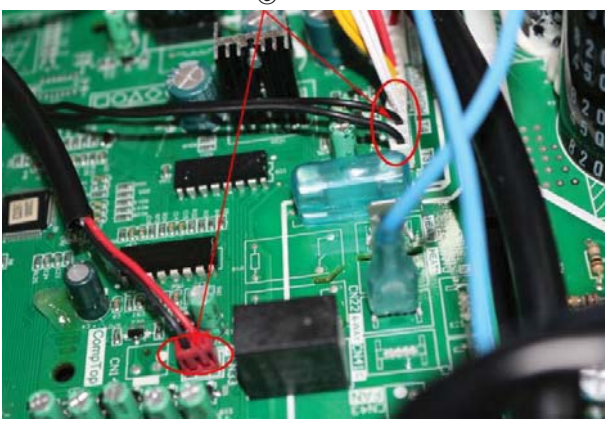
3	Electrical parts	<p>How to remove the electrical parts.</p> <p>1) After finish work of item 1 and item 2, remove the connector for the compressor</p> <p>2) Pull out the two blue wires connected with the four way valve.</p> <p>3) Pull out connectors of the, condenser coil temp. sensor(T3),outdoor ambient temp. sensor(T4) and discharge temp. sensor(TP).</p>	  
---	------------------	--	--

4) Disconnect the pressure switch connector.

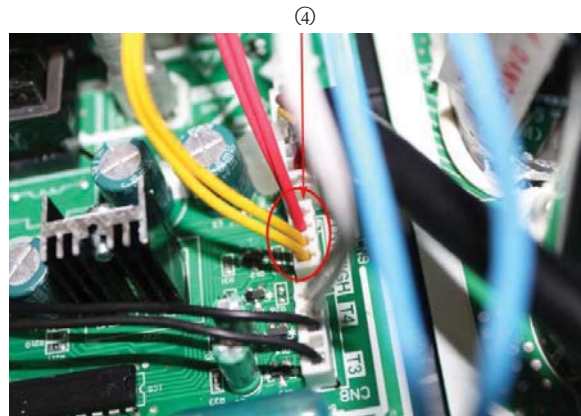

5) Disconnect the electronic expansion valve wire from the control board





6) Remove the ground wires .

7) Remove the wires(1,2,3 or L1,L2,S).

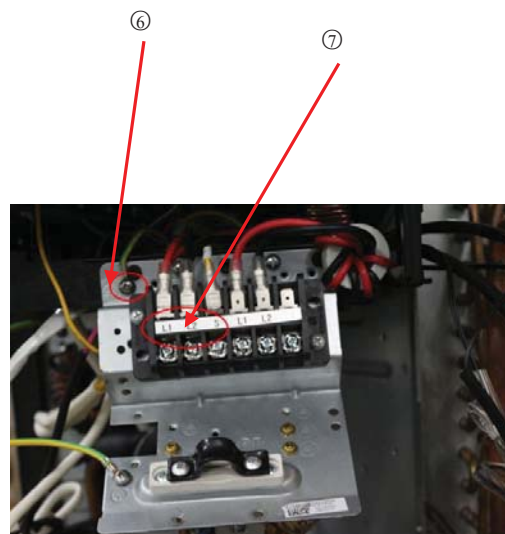
Then remove the electronic control box.

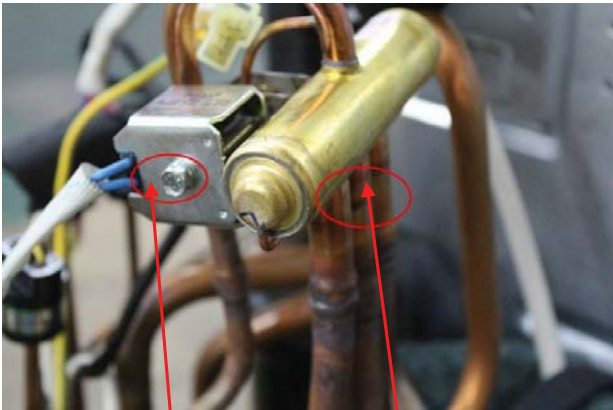

4	Four-way valve	<p>How to remove the four-way valve.</p> <ol style="list-style-type: none"> 1) Perform work of item 1,3. 2) Recover refrigerant from the refrigerant circuit. 3) Remove the screw of the coil and then remove the coil. 4) Detach the welded parts of four-way valve and pipe. 5) Then the four-way valve ass'y can be removed 	<p>The picture of four-way valve may be different from the one on your side.</p>  <p style="text-align: center;">③ ④</p>
5	Compressor	<p>How to remove the compressor.</p> <ol style="list-style-type: none"> 1) After perform work of item 1,3. Recover refrigerant from the refrigerant circuit. 2) Remove the discharge pipe and suction pipe with a burner. 3) Remove the hex nuts and washers fixing the compressor on bottom plate. 4) Lift the compressor from the base pan assembly. 	 <p style="text-align: center;">②</p> <p style="text-align: right;">③</p>