

ARTIFOX

RACK

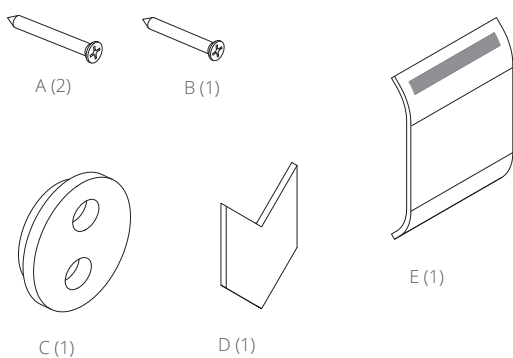

1

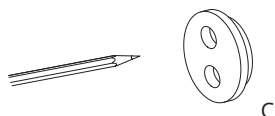

Use a stud finder (not included) and place the mounting disc (C) on an identified stud. Set it to your desired height and pre-drill through its screw holes.

2

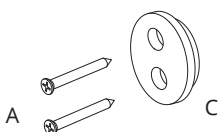

Fasten the mounting disc (C) to the stud. Use the 2 wood screws (A) and make sure screws grab hold of the stud.

3

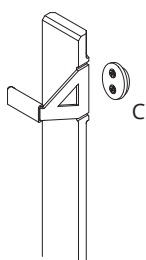

Once mounting disc (C) is securely fastened to the stud - hang RACK by placing it over the disc and pulling down until it locks in place.

4

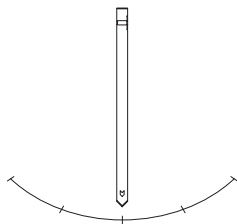

RACK should swing freely on the mounting disc so that you may level it vertically.

5

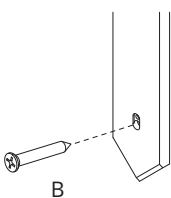

Once RACK is leveled predrill through the hole located at the bottom of RACK. Then use the wood screw (B) to hold RACK in place.

6

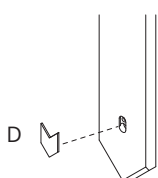

Place the fox head magnet (D) over the cavity to conceal the final screw.