

# Solar Powered Off Grid Back Up Schematic

Solar Panels - 3 in Series, up to 6 in Parallel ~90V

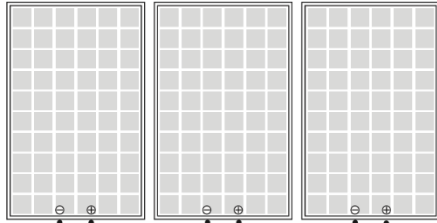

AWG 10 - MC4 Solar DC Wire

Schneider MPPT 150-60

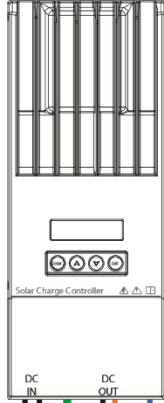

Conext SCP

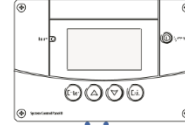

CATS Cable

Conext XW6848, XW6048

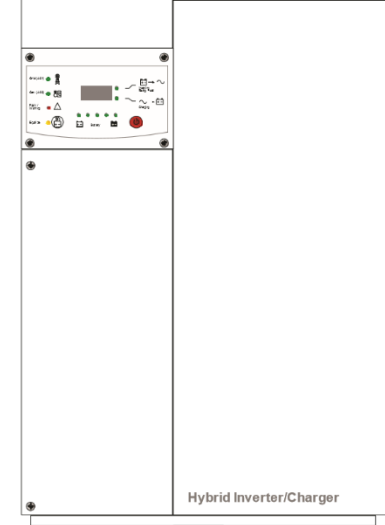

Hybrid Inverter/Charger

CATS Cable

10 AWG Wire

2/0 Double Insulated

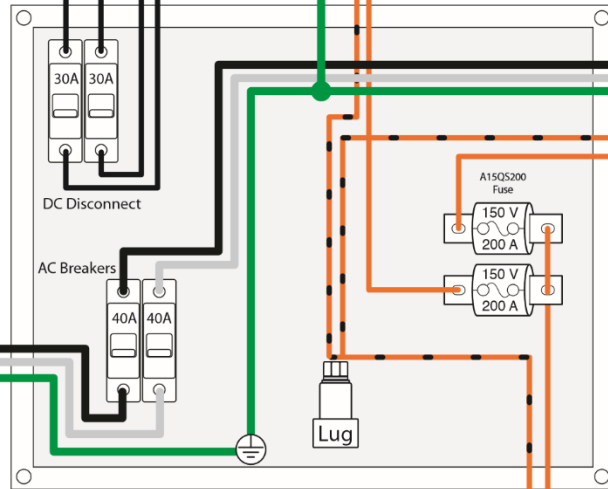

DC Disconnect

AC Breakers

NEMA 4 Rated Junction Box

AC Outlet  
NEMA 14-50

220  
VAC

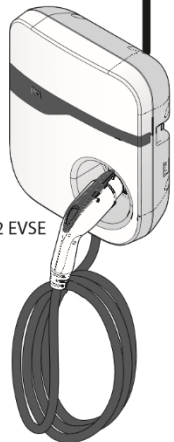

Level 2 EVSE

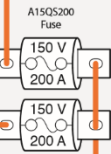

A15QS200  
Fuse

HBD41  
Cutoff Switch



57V Battery Pack - 21kWh

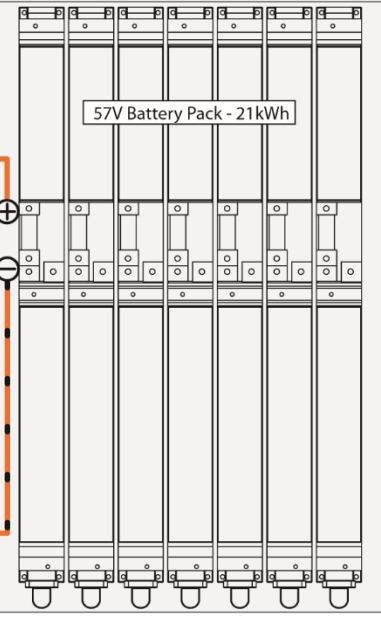

NEMA 4 Rated Battery Enclosure

2/0 Double Insulated