

# Uniform Catalog

YEAR 2022/23

THE LABEL FOR WORKWEAR

GREENCHEF

# STORY OF US

---

Loved and experienced by our  
customers since early 2010

IN THE SPOTLIGHT

The food and beverage may be *creme de la creme*, but the attire of the staff, whether they are front of the house or back of the house may say otherwise. This is the kind of thinking that traverses the mindset of the average consumer. As such, in some ways may account for why some hotels and restaurants lose business, while others proceed to gain more. There are multiple factors that go into the overall dining experience – professional look and feel are among the most important. Seeing an unmet need in the hospitality sector for professional uniform garments, the idea for GreenChef was born, to help professionals of the industry look the part.

# CONTENTS

---

<b>Food &amp; Beverage Uniform Collection</b>	<b>Page 04-62</b>
Classic Chef Jackets	04-18
Women Series	19-19
Japanese Series	20-22
Executive Chef Jacketets	23-26
Premium Chef Jackets	27-29
Chef Pants & Trousers	30-32
Aprons	33-50
Chef Hats, Beanies, and Caps	51-55
Table Linens & Accessories	56-62
<b>Shirts &amp; Tees Collection</b>	<b>Page 63-70</b>
Premium Polo T-Shirts	64-64
Oversized T-Shirts	65-65
Service Shirts	66-70
<b>Tailor Made by Beaboss</b>	<b>Page 71-72</b>
Information & Process	71-71
Case Studies	72-72
<b>Medical &amp; Healthcare Uniform Collection</b>	<b>Page 73-77</b>
Medical Scrub Tops	74-75
Medical Scrub Pants	76-76
Laboratory Coats	77-77
<b>Customisation Services</b>	<b>Page 78-83</b>
Embroidery & Printing	79-80
Size Charts	81-83
<b>Placement Guide</b>	<b>Page 84-91</b>

## Legends

Cotton blend  
100% Cotton  
Breathable with dri-fit  
Soft and satin touch  
Breathable with Dri-fit

---

**NEW**

SHORT  
COLLAR

TOOL  
POCKET

LET IT  
BREATHE

DRI-FIT  
SIDES



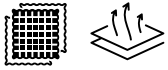

### MINT CHEF JACKET | 8067PC

- Square Short Collar
- Middle Yoke
- Exposed Snap Ring Buttons
- Pen/Thermometer Pocket on Left Sleeve
- Dri-fit Panel Sides for Ventilation and Stretch

Material: Polycotton (35% Cotton, 65% Polyester)

Size: XS — 4XL



SHORT SLEEVE ONLY

UNISEX

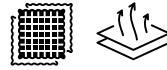

### MINT CHEF JACKET | 8067PC

- Square Short Collar
- Middle Yoke
- Exposed Snap Ring Buttons
- Pen/Thermometer Pocket on Left Sleeve
- Dri-fit Panel Sides for Ventilation and Stretch

Material: Polycotton (35% Cotton, 65% Polyester)

Size: XS — 4XL



LONG SLEEVE ONLY

UNISEX



WHITE  
DRI-FIT



BLACK  
DRI-FIT



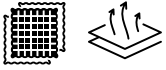

## PEPPERMINT WHITE CHEF JACKET | 8058PC

Middle Yoke, Mandarin Collar  
Dri-fit Back Panel  
Concealed Snap Buttons  
Pen Pocket on Left Sleeve  
Side Slit for Movement

Material: Polycotton (35% Cotton, 65% Polyester), Dri-fit

Size: XS — 4XL



LONG SLEEVE ONLY

UNISEX

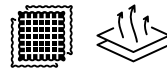

## PEPPERMINT BLACK CHEF JACKET | 8058PC

Middle Yoke, Mandarin Collar  
Dri-fit Back Panel  
Concealed Snap Buttons  
Pen Pocket on Left Sleeve  
Side Slit for Movement

Material: Polycotton (35% Cotton, 65% Polyester), Dri-fit

Size: XS — 4XL



SHORT SLEEVE ONLY

UNISEX



WHITE  
DRI-FIT

BLACK  
DRI-FIT





## THYME CHEF JACKET | 8004PC

- Cross Over Yoke
- Concealed Snap Buttons
- Pen/Thermometer Pocket on Left Sleeve
- Side Slit for Movement

Material: Polycotton (35% Cotton, 65% Polyester)

Size: XS — 7XL



LONG/SHORT SLEEVE

UNISEX



### Pocket

Slot your pen, kitchen tools or tasting spoon right here

# All-time Favourite

The classic piece with single yoke chef jacket.



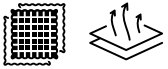

## PARSLEY WHITE CHEF JACKET | 8055PC

Cross-over Yoke with Overlapped Collar  
3 Concealed Snap Buttons  
Opens Half Way Through from Collar Opening  
Pen/Thermometer Pocket on Left Sleeve  
Full Dri-fit at the Back Panel

Material: Polycotton (35% Cotton, 65% Polyester), Dri-fit

Size: XS — 4XL



LONG SLEEVE ONLY

UNISEX

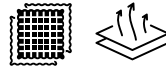

## PARLSEY BLACK CHEF JACKET | 8055PC

Cross-over Yoke with Overlapped Collar  
Red, Piping 3 Concealed Snap Buttons  
Opens Half Way Through from Collar Opening  
Pen/Thermometer Pocket on Left Sleeve  
Full Dri-fit at the Back Panel

Material: Polycotton (35% Cotton, 65% Polyester), Dri-fit

Size: XS — 4XL



SHORT SLEEVE ONLY

UNISEX



WHITE  
DRI-FIT



BLACK  
DRI-FIT







## BAY CHEF JACKET | 8064PV

- Slant Short Collar
- Crossed Over Yoke
- Exposed Snap Ring Buttons
- Pen/Thermometer Pocket on Left Sleeve
- Side Slits for Movements

Material: Polyviscose (35% Viscose, 65% Polyester)

Size: XS — 4XL

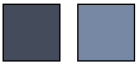

LONG SLEEVE ONLY

UNISEX



### Embroidery Ideas

Plain back allows branding to be done on the back. Take this chance to showcase your brand!



## Denim-like

No more fades!



## BANYAN CHEF JACKET | 8024CVC

Centre Yoke  
Standard Collar  
Concealed Snap Buttons  
Pen Pocket on Left Sleeve  
Side Slit for Movement

Material: Polycotton (35% Cotton, 65% Polyester)

Size: XS — 4XL



LONG/SHORT SLEEVE

UNISEX



# For those who love mandarin collars.





## HOLLY CHEF JACKET | 8053PC

- Slant Collar
- Crossed Over Yoke
- Concealed Snap Buttons
- Pen/Thermometer Pocket on Left Sleeve
- Side Slits for Movements

Material: Polycotton (35% Cotton, 65% Polyester)

Size: XS — 4XL



LONG/SHORT SLEEVE

UNISEX







## B.CLASSIC CHEF JACKET | 8046PC

- Double-breasted
- Plastic 4 holes button
- Mandarin Rounded Collar
- Pen/Thermometer Pocket on Left Sleeve
- Side Slit for Movement

Material: Polycotton (35% Cotton, 65% Polyester)

Size: XS — 4XL



LONG/SHORT SLEEVE

UNISEX



Slant Collar

Comfort on the neck

Pocket

Slot your pen, kitchen tools or tasting spoon right here



# All-time Classic Piece

The famous and traditional 10 buttons chef jacket for all chefs.



## TARRAGON CHEF JACKET | 8063PC

- Slant Short Collar
- Cross Over Yoke
- One 4 Holes Button, Concealed Snap Buttons
- Pen/Thermometer Pocket on Left Sleeve
- Side Slit for Movement

Material: Polycotton (35% Cotton, 65% Polyester)

Size: XS — 4XL



LONG SLEEVE ONLY

UNISEX



# The Modern Tarragon Chef Jacket





## WILLOW CHEF JACKET | 8052PC

Cross-over Yoke with Slant Stand Up Collar  
Concealed Snap Buttons, Contrasted Black Collar  
Black Lining on the Back  
Pen/Thermometer Pocket on Left Sleeve  
Side Slit for Movement

Material: Polycotton (35% Cotton, 65% Polyester)

Size: XS — 4XL



LONG/SHORT SLEEVE

UNISEX



# The Bold yet Minimal Jacket





## CAPER CHEF JACKET | 8054PC

Cross-over Yoke with Overlapped Collar  
Concealed Snap Buttons  
Contrasted Black Collar  
Pen/Thermometer Pocket on Left Sleeve  
Side Slit for Movement

Material: Polycotton (35% Cotton, 65% Polyester)

Size: XS — 4XL



LONG SLEEVE ONLY

UNISEX



# Small detail, big contrast.







## BASIL CHEF JACKET | 8050PC

Cross-over Yoke with Overlapped Collar  
 Concealed Snap Buttons  
 Contrasted White Half Piping Detailing on Front Yoke  
 Pen/Thermometer Pocket on Left Sleeve  
 Side Slit for Movement

Material: Polyviscose (35% Viscose, 65% Polyester)

Size: XS — 4XL



LONG/SHORT SLEEVE

UNISEX



### Pocket

Slot your pen, kitchen tools or tasting spoon right here

### Side slits

Better movement in the kitchen

# All-time Favourite

Great for the minimal and modern restaurants.





## OREGANO CHEF JACKET | 8057PC

Cross-over Yoke with Slant Collar  
Concealed Snap Buttons  
Concealed Left Chest Pocket  
Pen/Thermometer Pocket on Left Sleeve  
Side Slit for Movement

Material: Polycotton (35% Cotton, 65% Polyester)

Size: XS — 4XL



LONG SLEEVE ONLY

UNISEX



### Best Embroidery Placement

Place your logo/brand above the concealed pocket.



### Sleeve Pocket

Slot your pen, kitchen tools or tasting spoon right here



### Side Slits

Better movement in the kitchen

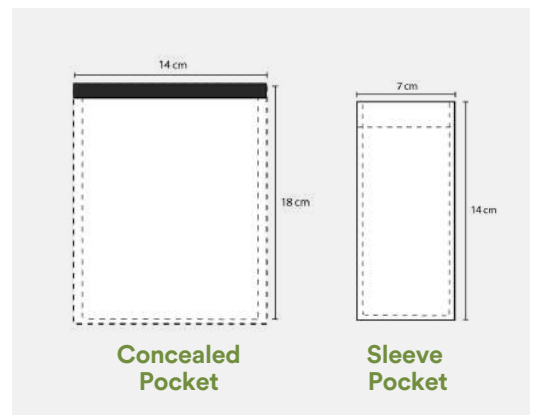



### SAFFRON CHEF JACKET | 8061PC

Mandarin Round Collar, Crossed-Over Yoke  
Plastic Round Detachable Buttons — Interchangeable  
Concealed Stainless Steel Snap Buttons  
Pen/Thermometer Pocket on Left Sleeve  
Side Slits for Movement

Material: Polycotton (35% Cotton, 65% Polyester)

Size: XS — 4XL



LONG SLEEVE ONLY

UNISEX



### ROWEN CHEF JACKET | 8065PC

Mandarin Round Collar  
Single-breasted  
Handrolled Stuffed Buttons  
Pen/Thermometer Pocket on Left Sleeve  
Side Slits for Movement

Material: Polycotton (35% Cotton, 65% Polyester)

Size: S — 4XL



LONG SLEEVE ONLY

UNISEX







## SAGE CHEF JACKET | 8059PC

Overlapped collar, Crossed-over yoke  
Concealed Snap Buttons  
White Contrast Trimming  
Pen/Thermometer Pocket on Left Sleeve  
Side Slits for Movement

Material: Polycotton (35% Cotton, 65% Polyester), Dri-fit

Size: XS — 4XL

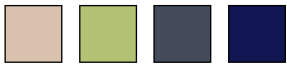

LONG SLEEVE ONLY

UNISEX



# Spice them up with colours.



Khaki



Green



Grey



Navy Blue



## ROSEMARY CHEF JACKET | 8058PC

Middle Yoke, Mandarin Collar  
Dri-fit Back Panel  
Concealed Snap Buttons  
Pen Pocket on Left Sleeve  
Side Slit for Movement

Material: Polycotton (35% Cotton, 65% Polyester), Dri-fit

Size: XS — 4XL



LONG SLEEVE ONLY

FEMALE



Green

Grey



Navy Blue

Khaki



Black



-----> **Pocket**

Slot your pen, kitchen tools or tasting spoon right here

-----> **Side slits**

Better movement in the kitchen



# Japanese Chef Series

GreenChef's Japanese chef series' chef jackets and coats designs are inspired by Japanese food culture and traditions.





### SUSHI COAT CHEF JACKET | 8009PC

- Cross-over Yoke
- No Buttons
- Straps Fastener on Inner and Outer
- Inner Pocket and Front Pocket
- Side Slit for Movement

Material: Polycotton (35% Cotton, 65% Polyester)

Size: S — 2XL



QUARTER SLEEVE

UNISEX



### MITSUBA CHEF JACKET | 8066PC

- Single-button
- Single-Breasted Yoke
- Pocket on Inner Left
- Side Slits for Movement

Material: Polycotton (35% Cotton, 65% Polyester)

Size: S — XL



QUARTER SLEEVE

UNISEX





## JAPANESE CHEF COAT | 8062PC

Three Buttons  
Single-Breasted Yoke  
3 Front Pockets  
Not Lined

Material: Polycotton (35% Cotton, 65% Polyester)

Size: XS — 2XL



SHORT SLEEVE ONLY

UNISEX





# Executive Series

A collection of executive chef jacket series by Greenchef.



## DILL CHEF JACKET | 8056DEN

Cross-over Yoke  
Exposed Metal Snap Buttons  
Mandarin Rounded Stand Up Collar  
Double Pocket on Left Chest, Pen Pocket on Left Sleeve  
Side Slit for Movement

Material: 100% Cotton, Denim

Size: XS — 4XL



LONG SLEEVE ONLY

UNISEX







LIMITED STOCKS



LIMITED STOCKS



### MEIJI CHEF JACKET | 8015CVC

- Cross Over Yoke
- Stitching details on Collar
- Exposed Snap Buttons
- Pen Pocket on Left Sleeve
- Side Slit for Movement

Material: CVC (55% Cotton, 45% Polyester)

Size: XS — 2XL



LONG SLEEVE ONLY

UNISEX



### COBE CHEF JACKET | 8030CVC

- Cross Over Yoke
- High Neck Collar
- Concealed Snap Buttons
- Pen Pocket on Left Sleeve
- Side Slit for Movement

Material: CVC (55% Cotton, 45% Polyester)

Size: XS — 2XL



SHORT SLEEVE ONLY

UNISEX



LIMITED STOCKS



LIMITED STOCKS



### MILLETTIA CHEF JACKET | 8003CVC

- Cross-over Yoke with Overlapped Collar
- Concealed Snap Buttons
- Contrasted Black Shoulder and Collar
- Pen Pocket on Left Sleeve
- Side Slit for Movement

Material: CVC (55% Cotton, 45% Polyester)

Size: XS — 2XL



SHORT SLEEVE ONLY

UNISEX



### MISSION CHEF JACKET | 8043PV

- Centre Yoke
- Standard Collar
- Concealed Snap Buttons
- Pen Pocket on Left Sleeve
- Side Slit for Movement

Material: CVC (55% Cotton, 45% Polyester)

Size: XS — 2XL



LONG SLEEVE ONLY

UNISEX



# Premium Series

A collection of premium chef jacket series by Greenchef.



### PINE WHITE CHEF JACKET | 8019CVC

Crossed-Over Asymmetrical Yoke  
Square Mandarin Collar  
Exposed First 3 Fabric Buttons, Concealed Snap Buttons  
Pen Pocket on Left Sleeve & Upper Front Chest  
Side Slit for Movement

Material: Satin CVC (55% Cotton, 45% Polyester)

Size: XS — 4XL



LONG SLEEVE ONLY

UNISEX



### MAPLE WHITE CHEF JACKET | 8055PC

Mandarin Round Collar  
Single-Breasted Yoke  
Concealed Snap Buttons  
Pen/Thermometer Pocket on Left Sleeve  
Side Slits for Movement

Material: Polycotton (35% Cotton, 65% Polyester), Dri-fit

Size: XS — 4XL



LONG SLEEVE ONLY

UNISEX







### P.CLASSIC WHITE CHEF JACKET | 8046CVC

Cross Over Yoke, Rounded Mandarin Collar  
Exposed First 3 Four-Holes Fabric Buttons  
10 Fabric Four Holes Buttons  
Pen Pocket on Left Sleeve  
Side Slit for Movement

Material: CVC (55% Cotton, 45% Polyester)

Size: XS — 4XL



LONG SLEEVE ONLY

UNISEX



### CLOVER WHITE CHEF JACKET | 8055PC

Wrapped Collar  
Cross Over Yoke  
Concealed Snap Buttons  
Pen Pocket on Left Sleeve  
Side Slit for Movement

Material: CVC (55% Cotton, 45% Polyester)

Size: XS — 4XL



LONG SLEEVE ONLY

UNISEX





# Chef Pants & Trousers

Designed with comfort and durability as the first priority.



### BASIC CHEF PANTS | 1080PC

Elastic Waistband  
2 Side Pockets, 1 Back Pocket  
Regular Cut  
Drawstrings for Fastening

Material: Polycotton (35% Cotton, 65% Polyester), Dri-fit

Size (Black): XS — 7XL  
Size (White): XS — 4XL (Available in SG only)



### CHECKERED CHEF PANTS | 1080TR

Checkered Prints  
Elastic Waistband  
2 Side Pockets, 1 Back Pocket Regular Cut  
Drawstrings for Fastening

Material: Tetron Rayon

Size: XS — 5XL







### STRIPE CHEF PANTS | 1080TR

- Small Stripes \ Big Stripes
- Elastic Waistband
- 2 Side Pockets, 1 Back Pocket
- Regular Cut
- Drawstrings for Fastening

Material: Tetron Rayon

Size: XS — 4XL



### EXECUTIVE TROUSERS | 1020PC

- Black
- Belt Loops
- Metal Stud Button
- 2 Side Pockets, 1 Back Pocket Regular Cut
- Side Adjustable Tabs
- Front Zipper

Material: Polycotton (35% Cotton, 65% Polyester)

Size: XS — 4XL





# Aprons

Aprons made for all professional industries.

## BASIC BIB APRON | 608PC

Black / White / Olive Green / Maroon / Khaki Brown /  
Dark Brown / Navy Blue  
Adjustable Neck Straps  
One Right Pocket: 17cm X 18cm

Material: Polycotton (35% Cotton, 65% Polyester)

Size: Free



UNISEX

FREESIZE



Olive Green



Black



White



Maroon



Brown



Khaki

# Better Protected.



TWO  
POCKETS



BACK  
VIEW



## BASIC BIB APRON | 610PC

Grey  
Adjustable Neck Straps  
Center Pockets: 33cm X 19cm

Material: Polycotton (35% Cotton, 65% Polyester)

Size: Free



UNISEX

FREESIZE





### BIG STRIPES BIB APRON | 610PC

Big Stripes Print  
27" Width  
One Right Pocket: 17cm X 18cm

Material: Tetron Rayon

Size: Free



UNISEX

FREESIZE



### SMALL STRIPES BIB APRON | 610PC

Small Stripes Print  
27" Width  
One Right Pocket: 17cm X 18cm

Material: Tetron Rayon

Size: Free



UNISEX

FREESIZE

## BASIC HALF APRON | 608PC

Black / White / Olive Green / Maroon / Khaki Brown /  
Dark Brown / Navy Blue  
One Right Pocket: 17cm X 18cm

Material: Polycotton  
(35% Cotton, 65% Polyester)

Size: Free



UNISEX

FREESIZE



Olive Green



Black



White



Maroon



Brown



Khaki



### BIG STRIPES CHEF APRON | 608PC

Big Stripes Print  
27" Width x 31" Length  
One Right Pocket: 17cm X 18cm

Size: Free

Material: Tetron Rayon



UNISEX

FREESIZE



### SMALL STRIPES CHEF APRON | 608PC

Small Stripes Print  
27" Width x 31" Length  
One Right Pocket: 17cm X 18cm

Size: Free

Material: Tetron Rayon



UNISEX

FREESIZE



## GRETAL SERVICE BIB APRON | 614P

A Full-width Skirt Apron  
X Crossed Back Straps  
One size, side buttons for adjustment  
Extendable Side Pockets  
Pen Pocket on Left Chest

Size: Free

Material: 100% Polyester



UNISEX

FREESIZE





## HANSEL SERVICE BIB APRON | 613P

Half-width Apron  
H Back Straps  
One size, back buttons for adjustment  
Extendable Side Pockets  
Pen Pocket on Left Chest

Size: Free

Material: 100% Polyester



UNISEX

FREESIZE

# Switch things up.

## XION BIB APRON | 815DEN

Blue / Green / Grey / Brown  
3 Pockets  
White Contrast Stitching  
Adjustable Length  
Crossback  
Original Black Straps

Size: Free

Material: 100% Cotton, Denim



UNISEX

FREESIZE



 \*PURCHASE WITH PURCHASE  
ADD-ON STRAPS

Black / Khaki / Brown / Red  
Material: Webbing



## XION BIB APRON | 815DEN

Blue / Green / Grey / Brown  
3 Pockets  
White Contrast Stitching  
Adjustable Length  
Crossback  
Original Black Straps

Size: Free

Material: 100% Cotton, Denim



UNISEX

FREESIZE



## BLAKE BIB APRON | 617PC

Cream White/ Emerald Blue/ Forest Green  
One Centre Pocket  
Adjustable Strap

Size: Free

Material: Polycotton (35% Cotton, 65% Polyester)



UNISEX

FREESIZE

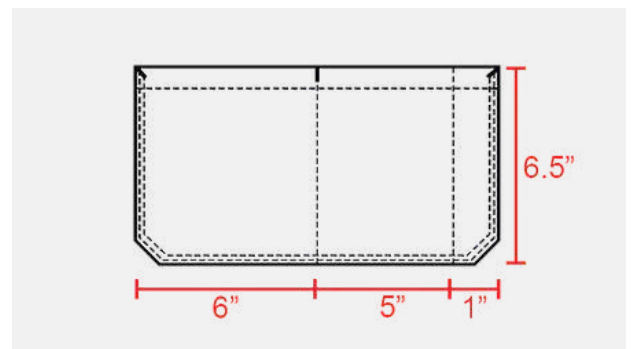





## KAI HALF APRON | 614P

Black/ Grey/ Beige  
Centre Pocket

Size: Free

Material: Polycotton (35% Cotton, 65% Polyester)



UNISEX

FREESIZE



STRAPS



### SHORT SERVICE APRON | 606PC

Black  
Front Three Pockets  
Adjustable Strap / Velcro

Size: Free

Material: Polycotton (35% Cotton, 65% Polyester)



UNISEX

FREESIZE



### FLAP CHEF APRON | 612PC

White / Black  
Flap for Extra Protection  
Adjustable Strap

Size: Free

Material: Polycotton (35% Cotton, 65% Polyester)



UNISEX

FREESIZE



### FLAP ANGLED CHEF APRON | 601PC

Straps Fasteners  
Flap for Extra Protection  
Multiple pocket compartments  
Back pocket for a card or tools

Size: Free

Material: Polycotton (35% Cotton, 65% Polyester)



UNISEX

FREESIZE



### FLAP CHEF APRON WITH SLIT | 605PC

Straps Fasteners  
Flap for Extra Protection  
Hidden Pocket Under the Flap  
Slit for movement

Size: Free

Material: Polycotton (35% Cotton, 65% Polyester)



UNISEX

FREESIZE

# Denim Apron

This range featuring our Best Sellers In-House Denim Aprons.

Designed considerately and minimally for our clients to easily custom their aprons with their brand identity and names.







### MARTIS DENIM APRON | 814DEN

Strap Fasteners  
Multi-compartment for Tools  
Adjustable Neck Straps

Size: Free

Material: 100% Cotton, Denim



UNISEX

FREESIZE



### TAYLOR DENIM APRON | 819DEN

Strap Fasteners  
Multi-compartment for Tools  
Adjustable Neck Straps

Size: Free

Material: 100% Cotton, Denim



UNISEX

FREESIZE



### NOAH DENIM APRON | 817DEN

Black  
Adjustable Neck Strap  
Golden Stitching  
Two Front Pockets: 32cm X 19cm

Size: Free

Material: 100% Cotton, Denim



UNISEX

FREESIZE



### JOEY DENIM APRON | 815DEN

Bluish Black  
Adjustable Neck Strap  
Golden Stitching  
Two Front Pockets: 16cm X 19cm each

Size: Free

Material: 100% Cotton, Denim



UNISEX

FREESIZE

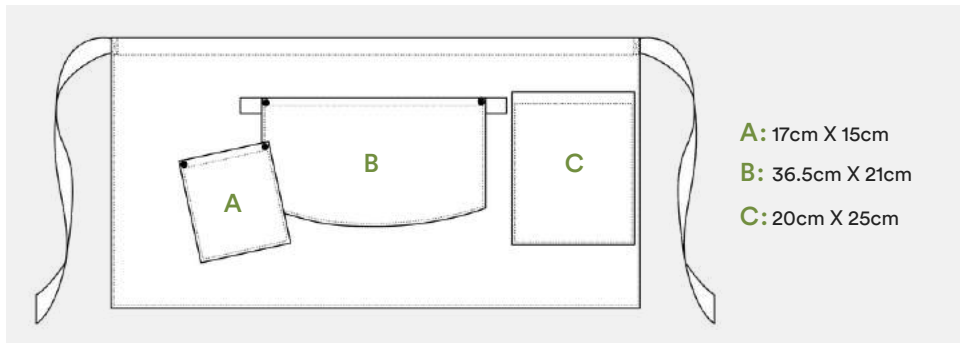

### GWEN HALF APRON | 816DEN

Black / Blue  
Multi-compartment  
Key hook and loop

Material: 100% Cotton, Denim



UNISEX

FREESIZE



# Chef Hats, Beanies, and Caps





### CARIBBEAN | 502PC

Black / White / Small Stripes  
Adjustable with Straps  
Freesize  
Material: Polycotton (35% Cotton, 65% Polyester)  
Unisex Cut



UNISEX

FREESIZE



### BLUEBELL BANDANA | 508PC

Black  
Stretchable Elastic Band  
Freesize  
Material: Polycotton (35% Cotton, 65% Polyester)  
Unisex Cut



UNISEX

FREESIZE



### PRODUCTION CAP | 507PC

Black / White  
Back Netting for Ventilation  
Stretchable Elastic Band  
Freesize  
Material: Polycotton (35% Cotton, 65% Polyester)  
Unisex Cut



UNISEX

FREESIZE



### HEADWRAP | 501PC

Black / White  
Adjustable Sizing with Straps  
Freesize  
Material: Polycotton (35% Cotton, 65% Polyester)  
Unisex Cut



UNISEX

FREESIZE



**FREESIA CHEF BEANIE | 504PC-VENT**

Black / White  
 Netting for Ventilation  
 Stretchy Elastic Band  
 Freesize  
 Material: Polycotton (35% Cotton, 65% Polyester)  
 Unisex Cut



UNISEX

FREESIZE



**FREESIA CHEF BEANIE, NO VENT| 504PC**

Black / White  
 Adjustable Elastic Band  
 Freesize  
 Material: Polycotton (35% Cotton, 65% Polyester)  
 Unisex Cut



UNISEX

FREESIZE



**DANDELION CHEF BEANIE | 509PC**

Black / White  
 Velcro Adjustable  
 Double Layered for Structure  
 Freesize  
 Material: Polycotton (35% Cotton, 65% Polyester)  
 Unisex Cut



UNISEX

FREESIZE



**GLADIOLUS CHEF BEANIE | 511PC**

Black / White  
 Velcro Adjustable  
 Double Layered for Structure  
 Freesize  
 Material: Polycotton (35% Cotton, 65% Polyester)  
 Unisex Cut



UNISEX

FREESIZE



BACK  
VIEW

### POPPY CHEF TOQUE | 506PC

Black / White  
Adjustable Straps

Size: Free

Material: Polycotton (35% Cotton, 65% Polyester)



UNISEX

FREESIZE



### POPPY CHEF TOQUE | 506PC

Small Stripes / Big Stripes / Checked  
Adjustable Straps

Size: Free

Material: Polycotton (35% Rayon, 65% Tectron)



UNISEX

FREESIZE



### DISPOSABLE CHEF TOQUE | 506PC

Black/ White  
2 Heights- 29cm / 23cm  
Tape Closure  
Water Repellent  
Curved Top with Air Ventilation

Size: Free

Material: Non-Woven Fabric



UNISEX

FREESIZE



### RYKER WASHED CAP | 516C

Black / Navy Blue/ Khaki/ Maroon/ Red/ Teal Blue  
Adjustable Buckle Fastener

Material: 100% Cotton



UNISEX

FREESIZE



### RYDER BASEBALL CAP | 512P

Black/ Grey/ Navy Blue  
Adjustable Buckle Fastener  
6 Panels, Netting for Ventilation

Material: Dri-fit & Netting



UNISEX

FREESIZE



### REX BASEBALL CAP | 513C

Black  
Adjustable Buckle Fastener

Material: 100% Cotton



UNISEX

FREESIZE



### ----- | 514C

-----  
----

Material: 100% Cotton, Denim



UNISEX

FREESIZE





# Accessories

# Towels

## 1. KITCHEN / TEA TOWEL | 1203G



**Material:** 100% Baumwolle Cotton

**Suitable for:** Everyday Use — wiping up spills, drying plates, holding hot dishes

**Colours:** Green / Red / Purple / Yellow / Brown



VERSATILE

MULTI-COLOURED

## 2. WAFFLE KITCHEN TOWEL | 815DEN



**Material:** 100% Cotton

**Suitable for:** Everyday Use — wiping up spills, drying plates, holding hot dishes

**Colours:** Brown / Grey / Dark Grey / Pink / White / Light Khaki / Green / Dark Green



VERSATILE

MULTI-COLOURED

### 3. COMPRESSED TOWEL | 815DEN



**Material:** 100% Plant Fibre

**Suitable for:** Everyday Use — Beauty Spa care, Personal Daily Care, Baby Daily Care, Travelling

**Colours:** Brown / Grey / Dark Grey / Pink / White / Light Khaki / Green / Dark Green



### 4. CELLULOSE KITCHEN TOWEL | 1203G



**Material:** Wood Pulp

**Suitable for:**

- Dry dishes, Wiping of Countertops
- Excellent Water Absorbency

**Colours:** Green / Red / Purple / Yellow / Brown



### 5. MICROFIBRE TOWEL | 815DEN



**Material:** 100% Microfibre

**Suitable for:** Wine Cloth

**Colours:** Brown / Grey / Dark Grey / Pink / White / Light Khaki / Green / Dark Green



# Tablecloth Customisation

Minimum Order: 10pcs per size

Size: to your choice

Material 1:  
Polycotton (35% Cotton, 65% Polyester)

Material 2:  
Polyviscose (35% Viscose, 65% Polyester)

Material 3:  
100% Polyester

Material 4:  
100% Cotton

Material 5:  
Linen

Printing Method: Silkscreen Printing

Colour: to your choice

## TIPS!

### - Decide on the drop length

Short (8 inches to 12 inches):  
This gives an informal look and is great for everyday use.

Mid-length (16 inches to 24 inches):  
This length is considered semi-formal.

Floor-length (28 inches to 29 inches):  
Very formal look.

### - Decide on the hem

Standard (1/4 inch):  
Used on most of the tablecloth for dining.

Small (1/6 inch):  
For small surface area.

Very Small (1/8 inch):  
For small surface area. Not applicable to thick fabric

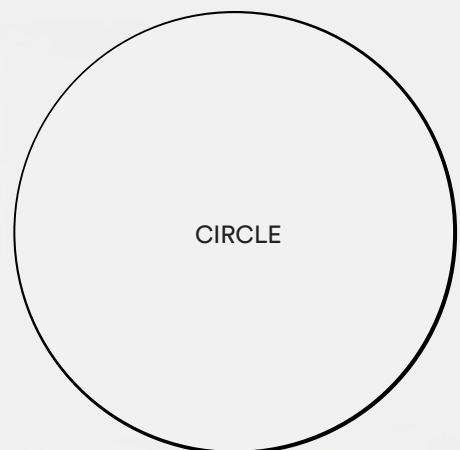
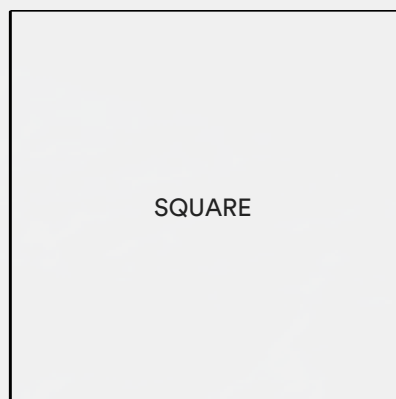
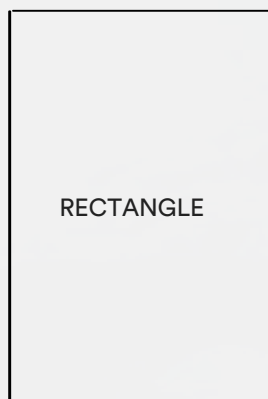





## WHITE NAPKIN | 2020PC

White  
20 x 20 inches / 50.8 x 50.8cm

Material: Polycotton  
(35% Cotton, 65% Polyester)



22 Inches

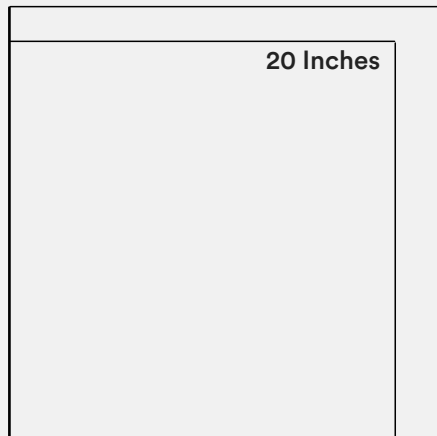

## NAPKIN CUSTOMISATION

Minimum Order: 100pcs

Size 1: 20 x 20 inches / 50.8 x 50.8cm  
Size 2: 22 x 22 inches / 55.8 x 55.8cm

Material 1: Polycotton  
(35% Cotton, 65% Polyester)  
Material 2: Polyviscose  
(35% Viscose, 65% Polyester)

Colour: to your choice

# The Basic Ties

---



**MADE-TO-ORDER | MIN ORDER: 30PCS**

Standard Tie Width 3.25"

Material 1: Polyviscose (Matte)

Material 2: Polyester (Glossy)



Mustard Yellow



Brown



Teal



Forest Green



Light Blue



Maroon



Grey



Navy Blue



Purple



Red



**THE CLASSIC BLACK TIE | TIE-B001**

Standard Tie Width 3.25"

Material 1: Polyviscose (Matte)

Material 2: Polyester (Glossy)



# Custom NeckTies

## CUSTOMISABLE NECKTIE

Stripes / Prints / Textured / Coloured  
Minimum Order Quantity: 100 pieces

1. Send us your design for a quotation.
2. Let us know the necktie size you prefer.
3. Mass production in 2-3 weeks

Get a quote!





# Polo & Tees

Designed with comfort and durability as the first priority.



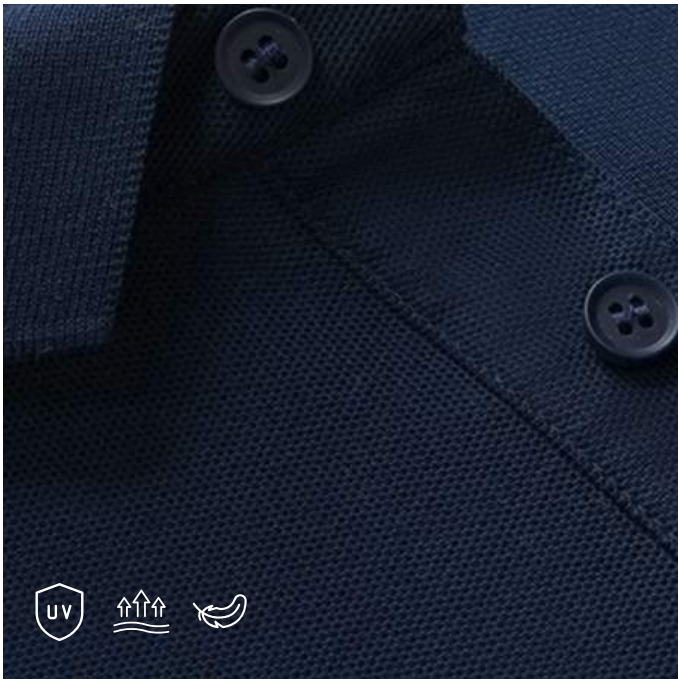

## PREMIUM POLO | PTS004CP

Standard Collar  
3 Buttons Placket  
Side Silts

Size: XS — 4XL

Material: Cotton Blend (65% Cotton, 35% Polyester)

+ Optional  
Left Chest Pocket \$5.00/pc  
4.5" width x 5.2" height



Left/Right Sleeve Pocket \$5.00/pc



UNISEX

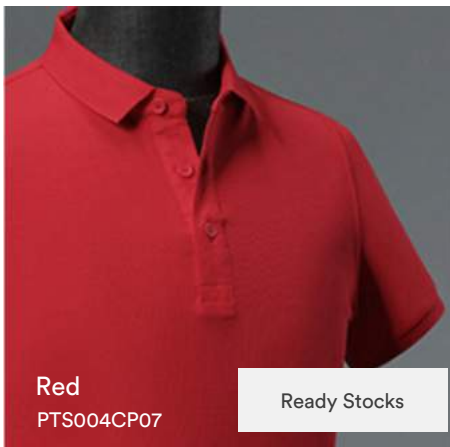
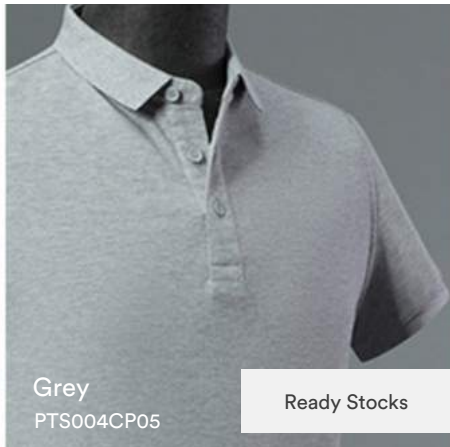
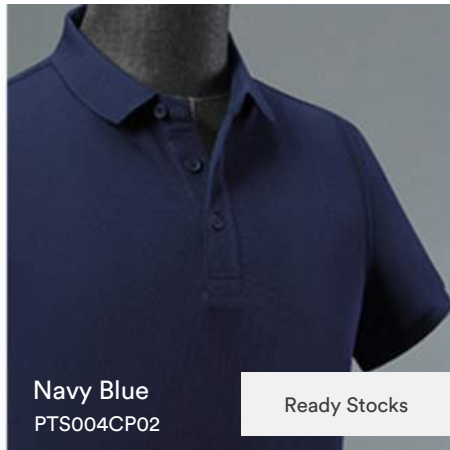



## OVERSIZED ROUND NECK T-SHIRT

Standard Collar  
3 Buttons Placket  
Side Silts

Size: XS — 4XL

Material: Cotton Blend (65% Cotton, 35% Polyester)

+ Optional  
Left Chest Pocket \$5.00/pc  
4.5" width x 5.2" height



Left/Right Sleeve Pocket \$5.00/pc



UNISEX



MOQ: 30pcs



# NEW SHIRT

## BLACK COLLAR SHIRT, FEMALE | 9012PC

White

Standard Collar

1 Visible Button on the Shirt's Collar

5-6 Buttons Concealed Under Shirt's Placket

One button Square Cuff

Shirt Wrinkling Reduced

Size: XS - 4XL

Material: Super Combed Cotton



LONG SLEEVE

FEMALE CUTTING

# COMING SOON

# NEW SHIRT

## BLACK COLLAR SHIRT, FEMALE | 9012PC

White

Standard Collar

1 Visible Button on the Shirt's Collar

5-6 Buttons Concealed Under Shirt's Placket

One button Square Cuff

Shirt Wrinkling Reduced

Size: XS - 4XL

Material: Super Combed Cotton



LONG SLEEVE

FEMALE CUTTING

# COMING SOON



**WHITE COLLAR SHIRT, FEMALE | 9012PC**

Black

Standard Collar

1 Visible Button on the Shirt's Collar

5-6 Buttons Concealed Under Shirt's Placket

One button Square Cuff

Shirt Wrinkling Reduced

Size: XS - 4XL

Material: Super Combed Cotton



LONG SLEEVE

FEMALE



**BLACK COLLAR SHIRT, FEMALE | 9012PC**

White

Standard Collar

1 Visible Button on the Shirt's Collar

5-6 Buttons Concealed Under Shirt's Placket

One button Square Cuff

Shirt Wrinkling Reduced

Size: XS - 4XL

Material: Super Combed Cotton



LONG SLEEVE

FEMALE



## BLACK COLLAR SHIRT, UNISEX | 9012PC

Black  
Standard Collar  
1 Visible Button on the Shirt's Collar  
5-6 Buttons Concealed Under Shirt's Placket  
One button Square Cuff  
Shirt Wrinkling Reduced

Size: XS - 4XL

Material: Super Combed Cotton



LONG SLEEVE

UNISEX



## WHITE COLLAR SHIRT, UNISEX | 9012PC

White  
Standard Collar  
1 Visible Button on the Shirt's Collar  
5-6 Buttons Concealed Under Shirt's Placket  
One button Square Cuff  
Shirt Wrinkling Reduced

Size: XS - 4XL

Material: Super Combed Cotton



LONG SLEEVE

UNISEX



# Custom Shirt

Standard Sizes: MOQ 50 pieces  
Tailor Made: MOQ 1 piece

## COLLAR

Classic Collar / Medium Collar  
Spread Collar / Button Down Collar  
Long Point Collar / Semi-cutaway Collar  
Band Collar / The Club Collar  
Wingtip Collar / Mandarin Collar

## POCKET

Pocket  
No Pocket

## PLACKET

Exposed  
Concealed

## BUTTONS & BUTTONHOLES

Matching Buttons  
Non-matching Buttons  
Matching Buttonhole  
Non-matching Buttonholes



## PLEATS

Side Pleats  
Box Pleats  
Hang Loop

## CUFF

1 Button Square  
1 Button Round  
1 Button Angle  
2 Button Square  
2 Button Round  
2 Button Angle  
French Cuff Round  
French Cuff Square  
French Cuff Angle

## DARTS

Darts  
No Darts

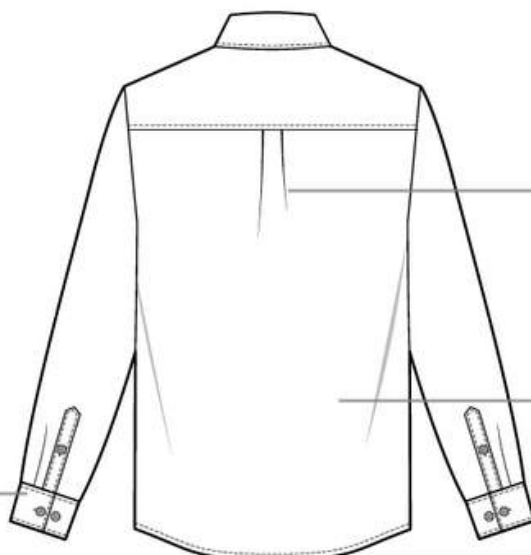

## HEM

Square  
Round



## FABRIC SELECTION

Wide selection of fabric and colours for you to choose from.

# BEABOSS

## Tailor Made Apparels

GreenChef is proud to introduce our new line in 2021, Beaboss, focusing on tailoring and supplying made to measure:

- Dress shirt
- 2 pieces suit
- 3 pieces suit
- Vest
- Blouse
- Dress
- Trousers and skirts
- & more

Custom tailoring and fine workmanship for:

- Corporate
- Banking & Finance
- Guest Relations
- Concierge
- Receptionist

Corporate Services includes:

### Design mockup for businesses

We provide businesses with a digital mockup of the apparel before mass production as we understand that big bulk purchases of custom items can sometimes be daunting.

### On-site measurement & fitting

On-site measurement is available if you have more than 5 pax for measurement. We will always cater to your company's schedule. Our tailors are always ready for on-site measurement up to 200 pax per day.

For more information:

[www.beaboss.sg](http://www.beaboss.sg)





# GALLERY

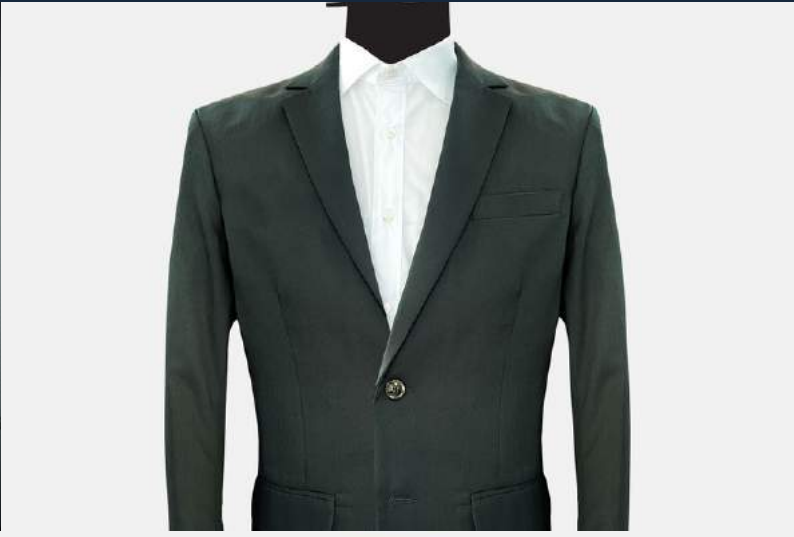



# Medical & Healthcare Uniform

NEW ARRIVAL



### EMMA SCRUB TOP, FEMALE | 9012PC

V Neck for comfort  
3 Front Pockets with 1 Pen Pocket  
Side Slit for Movement

Size: XS - 4XL

Material: TR Spandex



SHORT SLEEVE

FEMALE





NEW ARRIVAL



### LUCAS SCRUB TOP, MALE | 9012PC

V Neck for comfort  
3 Front Pockets with 1 Pen Pocket  
Side Slit for Movement

Size: XS - 4XL

Material: TR Spandex



SHORT SLEEVE

MALE





NEW ARRIVAL



### JAMIE SCRUB PANTS, UNISEX | 9012PC

Side Knee Pockets  
Drawstring Straps in The Waistband  
Matching Coloured Top

Size: XS - 4XL

Material: TR Spandex



SHORT SLEEVE

UNISEX





## LABRATORY COAT | 0001PC

White  
Three Front Pockets  
Button Closure  
Slits to reach inner pocket  
Back Slit

Size: XS — 4XL

Material: Polycotton (35% Cotton, 65% Polyester)



LONG SLEEVE

UNISEX



# Protect and Prevent.



A large industrial embroidery machine with multiple heads stitching a blue fabric. The machine is grey and white, with several heads visible, each with a needle and foot. The fabric is blue and has some white stitching on it. The machine is in a factory setting.

# Customisation Services

# Embroidery



## 1. LOGO EMBROIDERY

An embroidery looks crisp, distinct, and professional. It's precise with near-perfect quality, which is why it's the must-have imprint method to some of the fancy and elite. In addition, an embroidery can last a long time with right care of the garment - embroidery thread doesn't wash or fade out. An embroidery has a longer lifespan than ink transfer in screen printing as the thread holds up the fabric.

No minimum order. Setup fee is necessary for first-timers.

Amerigo BT

Arial

**BALLOON**

**Bauhaus 93**

*Brush Script M7*

*Brush 445*

Calligrapher

**Cooper Std Black**

**Egyptian 710**

*Kaufmann Bd*

**Tango BT**

**TimeScrDMed**

*Pacifico*

Table 1 —Preset Fonts

## 2. NAME EMBROIDERY FONTS

Common name embroidery colours can be referred from here. For logo embroidery, it is best to provide your pantone colour to match with our wide range of colour threads.

## 3. NAME EMBROIDERY COLOURS

Common name embroidery colours can be referred from here. For logo embroidery, it is best to provide your pantone colour to match with our wide range of colour threads.

Black	Grey 485	Gold 563	Red 703
White	D.Grey 488	Silver 483	Org 537
Blue 372	Yel 546	Pur 676	Grn 275
N.Blue 358	Brown 537	L.Pur 673	D.Gr 248
H.Pink 1086	Pink 1081		



# Printing



## 1. VINYL PRINTING

- ✓ Economical for simple designs
- ✓ Different textures and finishing
- ✓ Great for names
- ✓ Best for lower quantities
- ✓ Aprons, Hats, T-Shirt



## 2. DIGITAL HEAT TRANSFER

- ✓ Bright and detailed colours
- ✓ Best for lower quantities
- ✓ Gradients and effects
- ✓ Aprons, Hats, T-Shirt



## 3. SILKSCREEN PRINTING

- ✓ Solid and vivid colours
- ✓ Amazing washing qualities
- ✓ Economical for bulk quantities
- ✓ Aprons, T-Shirt



## 4. SUBLIMATION

- ✓ Economical for simple designs
- ✓ Different textures and finishing
- ✓ Great for names
- ✓ Best for lower quantities
- ✓ Aprons, Hats, T-Shirt



## 5. DIGITAL TRANSFER FILM

- ✓ Bright and detailed colours
- ✓ Best for lower quantities
- ✓ Gradients and effects
- ✓ Aprons, Hats, T-Shirt



## 6. EMBOSS

- ✓ Solid and vivid colours
- ✓ Amazing washing qualities
- ✓ Economical for bulk quantities
- ✓ Aprons, T-Shirt

### Chef Jackets Size Chart (Unisex)

Size	XS	S	M	L	XL	2XL	3XL	4XL	5XL	6XL	7XL
Short Sleeve	12"	12"	12.5"	13"	13.5"	14"	14.5"	15"	15"	15.5"	15.5"
Long Sleeve	23"	23"	23.5"	24"	24.5"	25"	25.5"	26"	26"	26.5"	26.5"
Shoulder	17"	17.5"	18"	18.5"	19"	19.5"	20"	20.5"	20"	20.5"	21"
Chest	40"	42"	44"	46"	48"	50"	52"	54"	55"	58"	60"
Shirt Length	28.5"	29"	29.5"	30"	30.5"	31"	31.5"	32"	32"	33"	33.5"

*\*Measurements are based on the actual product and are in inches (").*

### Chef Jackets Size Chart (Female)

Size	S	M	L	XL	2XL	3XL
Long Sleeve	21.5"	22"	22"	22.5"	23"	23.5"
Shoulder	15"	15.5"	16"	16.5"	17"	17.5"
Chest	36"	38"	40"	42"	44"	46"
Waist	32.5"	34.5"	36.5"	38.5"	40.5"	42.5"
Hip	40"	42"	44"	46"	48"	50"
Shirt Length	25.5"	26"	26.5"	27"	27.5"	28"

*\*Measurements are based on the actual product and are in inches (").*

### Sushi Coat Chef Jackets

Size	XS	S	M	L	XL	2XL
Shoulder	18"	18.5"	19"	19.5"	20"	20.5"
Chest	44"	46"	48"	50"	52"	54"
¾ Sleeve	14.5"	15"	15.5"	16"	16.5"	17"
Length	29"	29.5"	30"	30.5"	31"	31.5"

*\*Measurements are based on the actual product and are in inches (").*

### Laboratory Coat Size Chart

Size	XS	S	M	L	XL	2XL	3XL	4XL
Chest	39"	41"	43"	45"	47"	49"	51"	53"
Shoulder	16.5"	17"	17.5"	18"	18.5"	19"	19.5"	19.5"
Collar	16"	16.5"	17.5"	17.75"	18.5"	19"	19.5"	19.5"
Coat Length	38"	38.5"	39"	39.5"	40"	40.5"	41"	41.5"

*\*Measurements are based on the actual product and are in inches (").*

### Shirt Long Sleeve Size Chart, Unisex (9011CC)

Size	XS	S	M	L	XL	2XL	3XL	4XL	5XL	6XL
Neck Circumference	15	15.5	16	16.5	17	17.5	18	18.5	19	19.5
Shoulder	16.5	17	17.75	18.25	19	19.5	20	20.5	21	21.5
Short Sleeve	9.25	9.75	10.25	10.75	10.75	11	11.5	11.5	55	57
Long Sleeve	22.5	23.5	24.5	24.5	24.5	25	25	25.5	25.5	26
Shirt Length	27.5	28.5	29	29.5	30	30.5	31	31.5	32	32.5

*\*Measurements are based on the actual product and are in inches (").*

### Emma Scrub Top Size Chart — Women (8802TRS)

Size	XS	S	M	L	XL	2XL	3XL	4XL
Shoulder	14"	14.5"	15"	15.5"	16"	16.5"	17"	17.5"
Hip	37"	39"	41"	43"	45"	47"	49"	51"
Chest	36"	38"	40"	42"	44"	46"	48"	50"
Sleeve Length	7.75"	8"	8.25"	8.5"	8.75"	9"	9.25"	9.25"
Length	26.5"	26.5"	27"	27.5"	28"	28.5"	28.5"	28.5"

*\*Measurements are based on the actual product and are in inches (").*

### Lucas Scrub Top Size Chart — Men (8801TRS)

Size	XS	S	M	L	XL	2XL	3XL	4XL
Shoulder	16.5"	17"	17.5"	18"	18.5"	19"	19.5"	20"
Hip	38"	40"	42"	44"	46"	48"	50"	52"
Chest	38"	40"	42"	44"	46"	48"	50"	52"
Sleeve Length	8.5"	8.5"	8.75"	9"	9.25"	9.5"	10"	10"
Length	28"	28"	28.5"	29"	29.5"	30"	30.5"	31"

*\*Measurements are based on the actual product and are in inches (").*

### Jamie Scrub Pants Size Chart — Unisex (8803TRS)

Size	XS	S	M	L	XL	2XL	3XL	4XL
Waist	28"	30"	32"	34"	36"	38"	40"	42"
Hip	36.5"	38.5"	40.5"	42.5"	44.5"	46.5"	48.5"	50.5"
Length	39"	39"	40"	40.5"	41"	41.5"	42"	42"

*\*Measurements are based on the actual product and are in inches (").*

### Premium Polo T-Shirt – PTS004CP (S600)

Size	XS	S	M	L	XL	2XL	3XL	4XL
<b>Chest</b>	33.5"	35.5"	37.5"	39.5"	41.5"	43"	45"	47"
<b>Shoulder</b>	16.5"	16"	16.5"	17"	18"	19"	20"	20.5"
<b>Length</b>	25.5"	25"	26.5"	27"	28.5"	29"	30"	31"

*\*Measurements are based on the actual product and are in inches (").*

### Oversized T-Shirt, Short Sleeve, 240g 100% Cotton (WL-1068)

Size	XS	S	M	L	XL	2XL
<b>Chest</b>	54	56	58	60	62	64
<b>Shoulder</b>	54	56	58	60	62	64
<b>Sleeve Length</b>	21	22	23	24	25	26
<b>Shirt Length</b>	64	67	70	73	75	77

*\*Measurements are based on the actual product and are in centimeters (cm).*

### Jacob Zip Pants Size Chart (1020PC)

Size	28 (XS)	30 (S)	32 (M)	34 (L)	36 (XL)	38 (2XL)	40 (3XL)	42 (4XL)	44(5XL)
<b>Waist</b>	28	30	32	34	36	38	40	42	44
<b>Hip</b>	35	37	39	41	43	45	47	49	53
<b>Length</b>	39	40	40.5	40.5	40.5	40.5	40.5	41	41
<b>Thigh</b>	23.5	24	25.5	26.5	27.5	28.5	29	30	32

*\*Measurements are based on the actual product and are in inches (").*

### Chef Pants Size Chart, Adjustable Drawstrings (1080PC)

Size	XS	S	M	L	XL	2XL	3XL	4XL	5XL	6XL	7XL
<b>Waist</b>	28"	30"	32"	34"	36"	38"	40"	42"	44"	46"	48"
<b>Hip</b>	38"	40"	42"	44"	46"	48.5"	50"	52"	54"	48"	60"
<b>Length</b>	39"	40"	40"	40.5"	40.5"	41"	41"	41"	41.5"	41.5"	41.5"

*\*Measurements are based on the actual product and are in inches (").*



# Placements Guide

# Customisation Placements- Embroidery & Printing

## FRONT DESIGNS

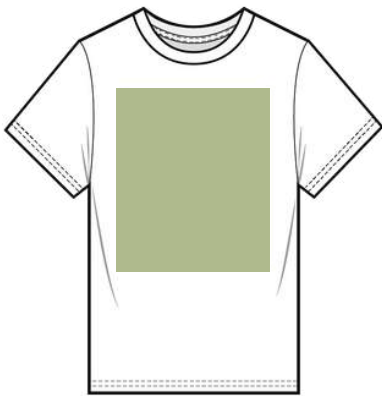

**FULL FRONT**

Max Imprint Area: 30cm x 35cm  
✓ Printing × Embroidery

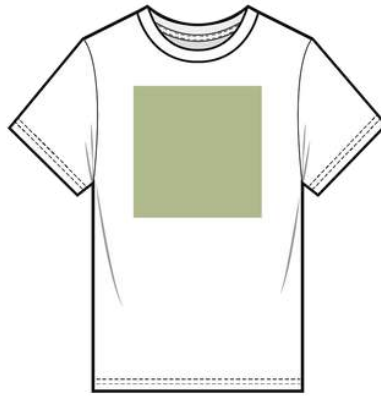

**MEDIUM FRONT**

Max Imprint Area: 20cm x 20cm  
✓ Printing ✓ Embroidery

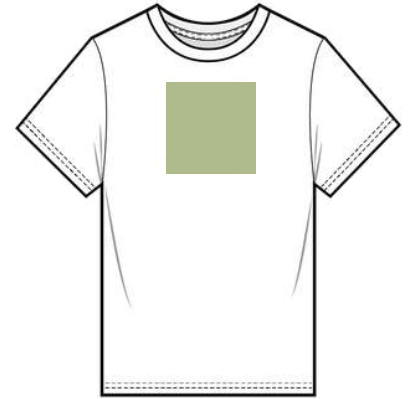

**CENTRE CHEST**

Max Imprint Area: 12cm x 12cm  
✓ Printing ✓ Embroidery

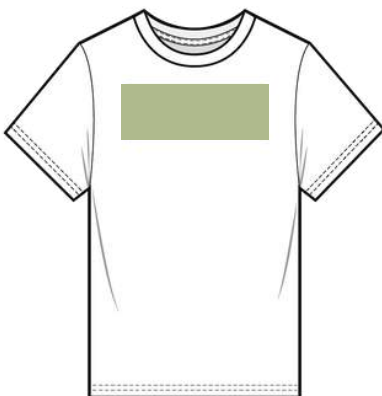

**ACROSS CHEST**

Max Imprint Area: 10cm x 30cm  
✓ Printing × Embroidery

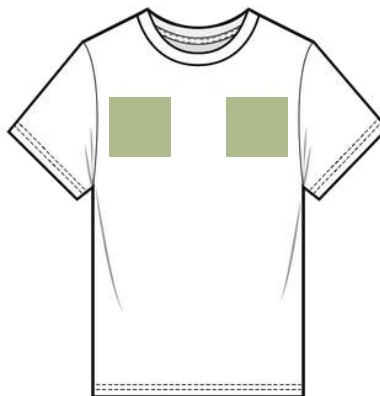

**LEFT & RIGHT CHEST**

Max Imprint Area: 12cm x 12cm each  
✓ Printing ✓ Embroidery



**LEFT & RIGHT SLEEVE**

Max Imprint Area: 8cm x 8cm each  
✓ Printing ✓ Embroidery

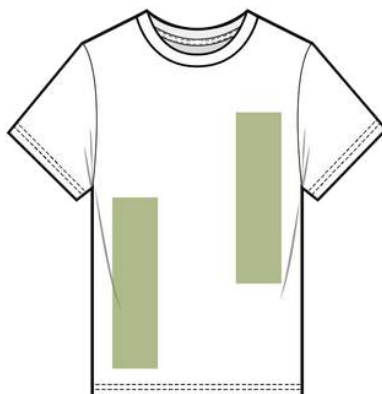

**LEFT AND RIGHT  
VERTICAL**

Max Imprint Area: 12cm x 35cm each  
✓ Printing × Embroidery

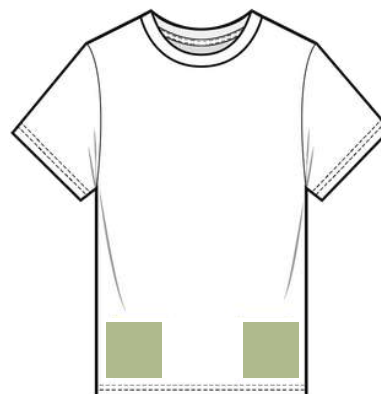

**LEFT AND RIGHT  
FRONT BOTTOM**

Max Imprint Area: 12cm x 15cm each  
✓ Printing ✓ Embroidery

# Customisation Placements- Embroidery & Printing

## BACK DESIGNS

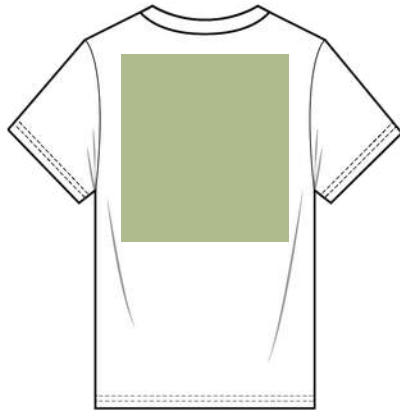

**FULL BACK**

Max Imprint Area: 30cm x 35cm

✓ Printing × Embroidery

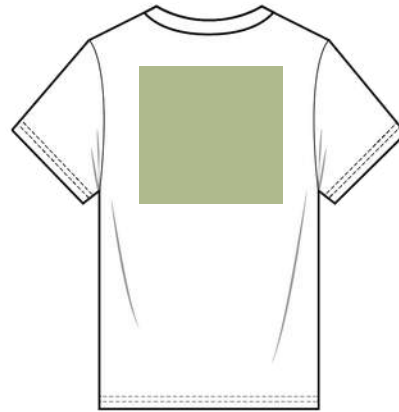

**MEDIUM BACK**

Max Imprint Area: 20cm x 20cm

✓ Printing ✓ Embroidery

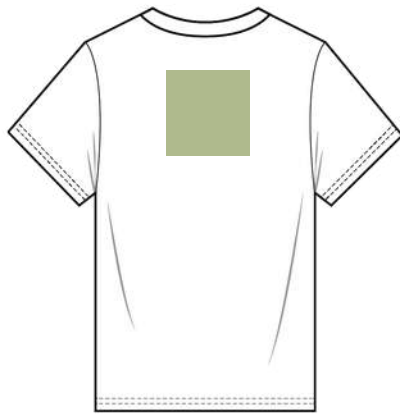

**CENTRE BACK**

Max Imprint Area: 12cm x 12cm

✓ Printing ✓ Embroidery

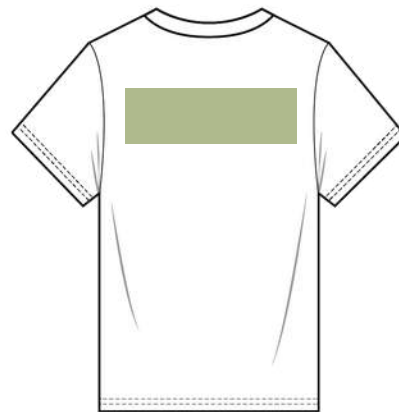

**ACROSS BACK**

Max Imprint Area: 10cm x 27-30cm

✓ Printing × Embroidery

### TOP DESIGN

Adult Size: 7cm X 7cm

Teen / Kids Size: 5cm X 5cm

### FRONT DESIGN

Adult Size: 10cm X 10cm

Teen / Kids Size: 7cm X 7cm

### BACK DESIGN

Adult Size: 20cm X 20cm

Teen / Kids Size: 15cm X 15cm

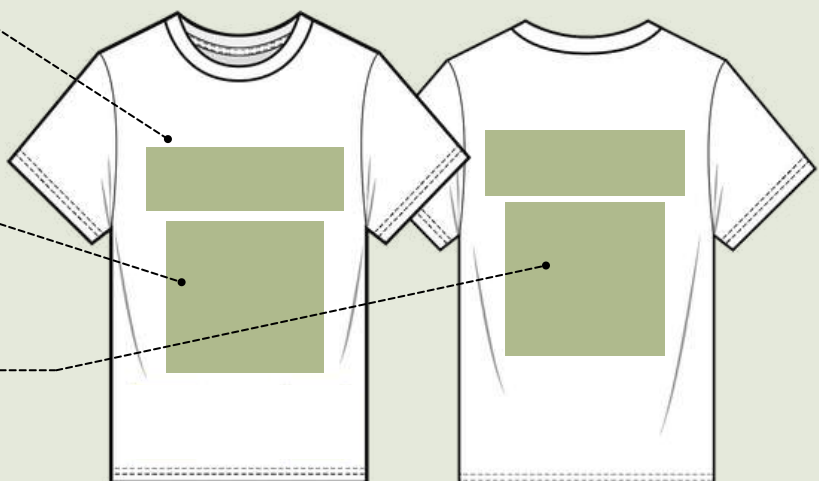

# Shirt Customisation Placements- Embroidery

## BACK DESIGNS



**LEFT & RIGHT CHEST**

Max Imprint Area: 30cm x 35cm



**LEFT & RIGHT SLEEVE**

Max Imprint Area: 20cm x 20cm

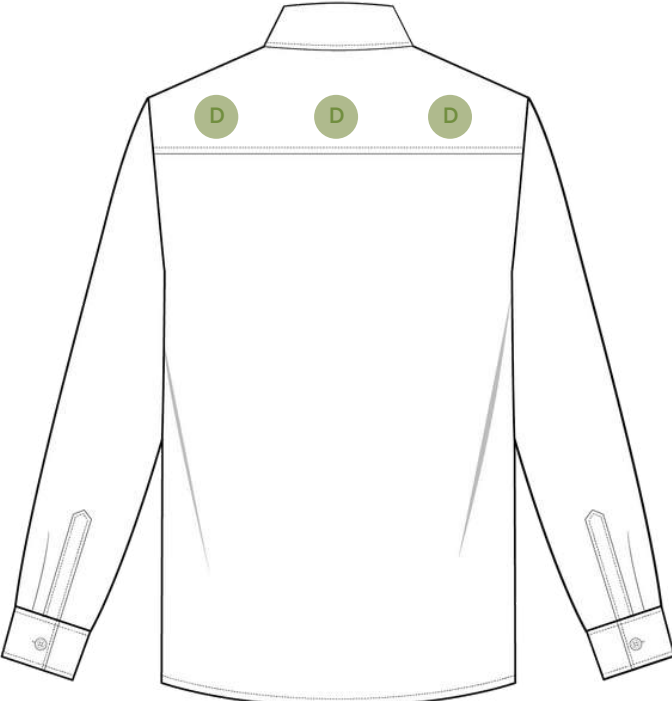

**CENTRE BACK**

Max Imprint Area: 12cm x 12cm



# Apron Customisation Placements- Embroidery & Printing



## TOP LEFT / RIGHT

Placement A & B: 2cm X 7cm  
Placement C & D: 9cm X 9cm  
✓ Printing ✓ Embroidery

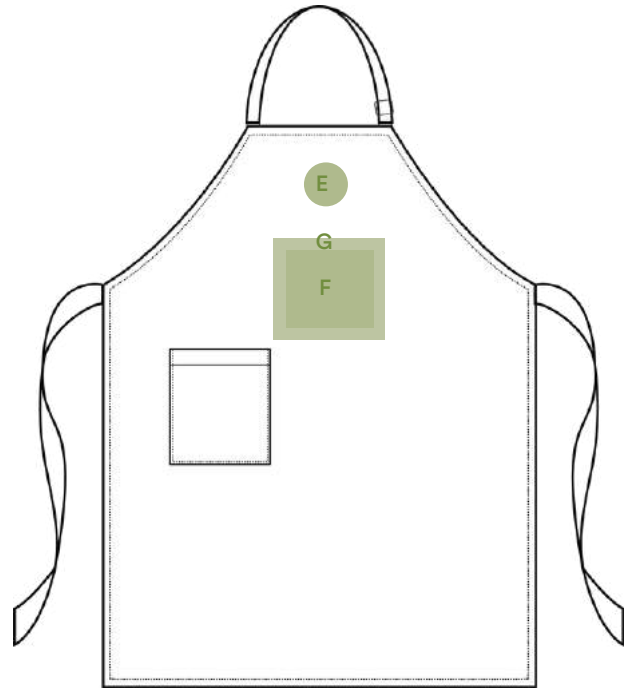

## CENTRE

Placement E: 2cm X 7cm  
Placement F: 9cm X 9cm  
Placement G: 20cm X 20cm  
✓ Printing ✓ Embroidery

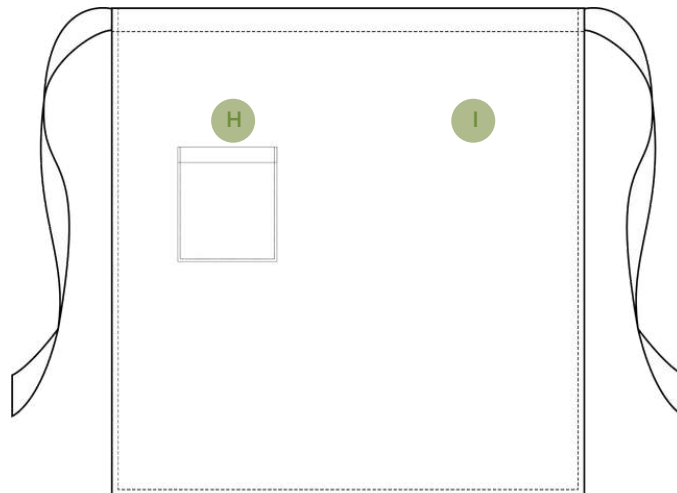

## LEFT & RIGHT CENTRE

Placement E & F: 9cm X 9cm  
✓ Printing ✓ Embroidery

# Cap Customisation Placements- Embroidery

## BASEBALL CAP

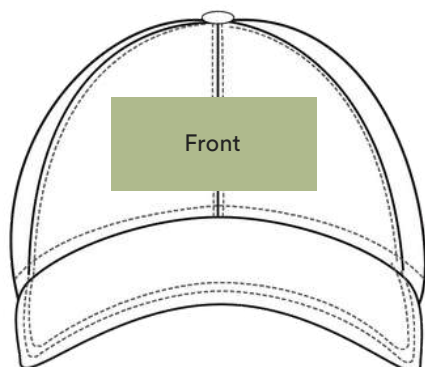

### FRONT, BACK, SIDE PANELS

Size: 9cm X 9cm

× Printing ✓ Embroidery

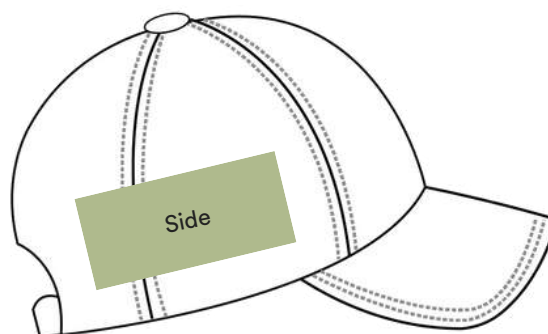
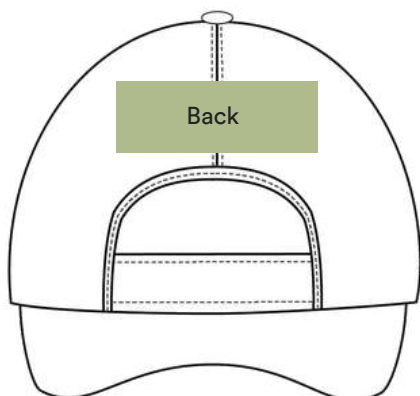

## CHEF HAT

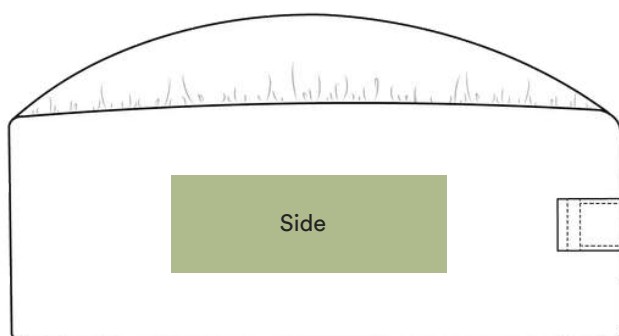

### LEFT & RIGHT SIDE

Placement E & F: 9cm X 9cm

✓ Printing ✓ Embroidery

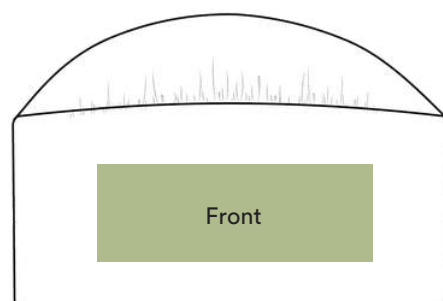

### FRONT CENTRE

Placement E & F: 9cm X 9cm

✓ Printing ✓ Embroidery

# Chef Customisation Placements- Embroidery & Printing

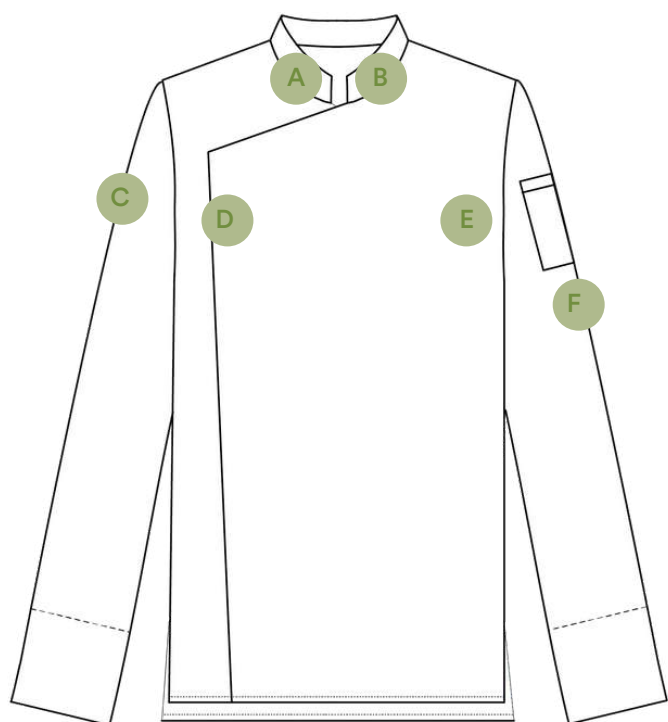

## LONG SLEEVE JACKET

Placement A & B: 7cm X 2cm  
Placement C, D, G, E, F: 9cm X 9cm

✓ Printing ✓ Embroidery

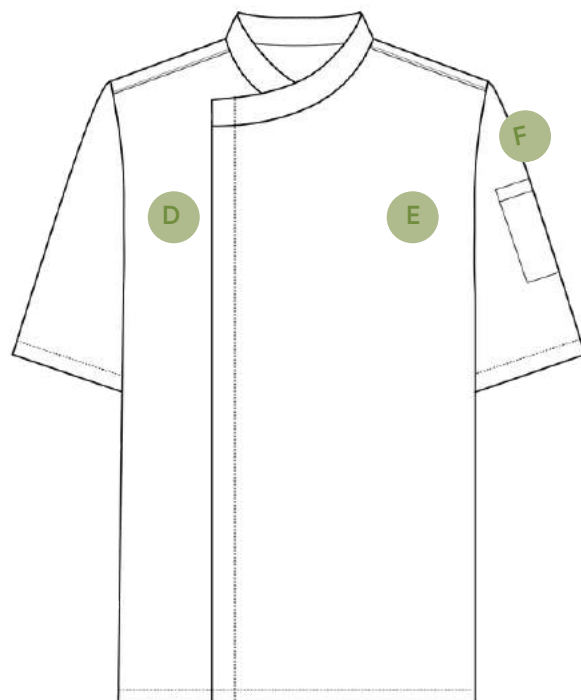

## SHORT SLEEVE JACKET

Placement G, H, I: 9cm X 9cm

✓ Printing ✓ Embroidery



## BACK

Placement J: 9cm X 9cm

✓ Printing ✓ Embroidery

# Laboratory Coat Embroidery Placements

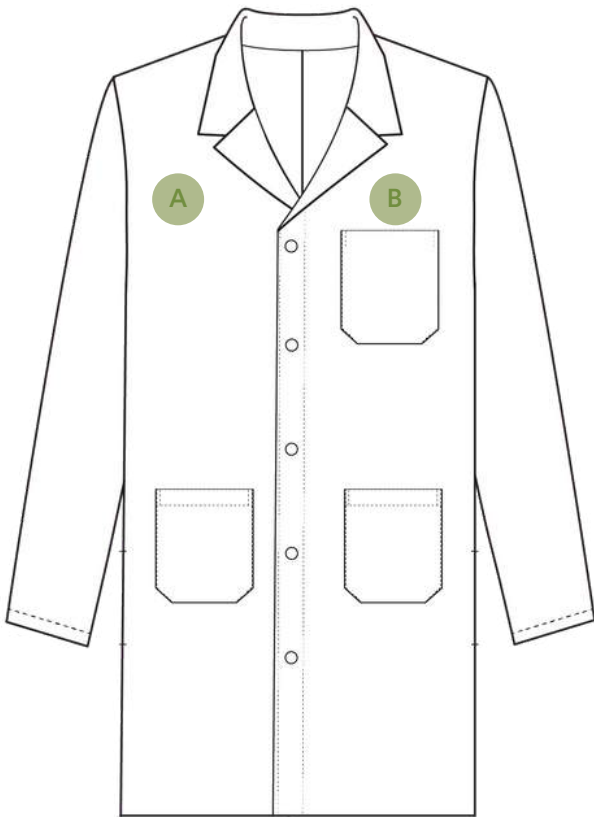

## FRONT

Placement A & B : 9cm X 9cm

✓ Printing ✓ Embroidery

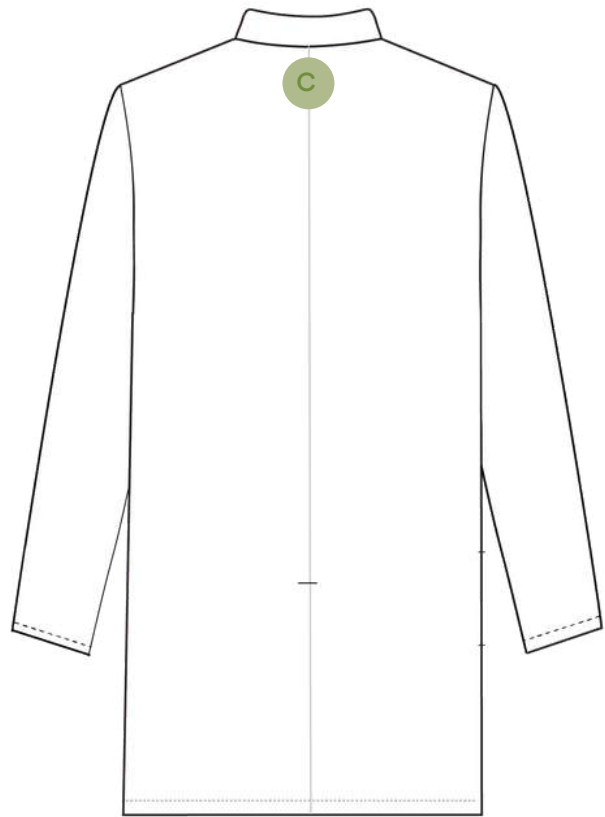

## BACK

Placement C: 9cm X 9cm

✓ Printing ✓ Embroidery

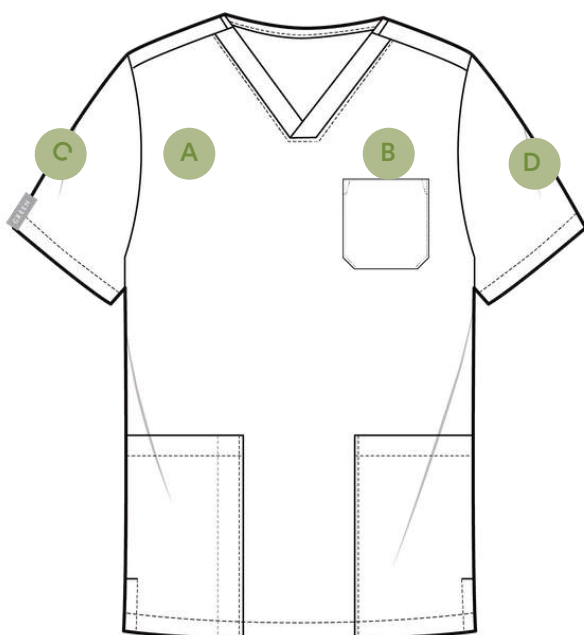

## FRONT

Placement A, B, C, D: 9cm X 9cm

✓ Embroidery

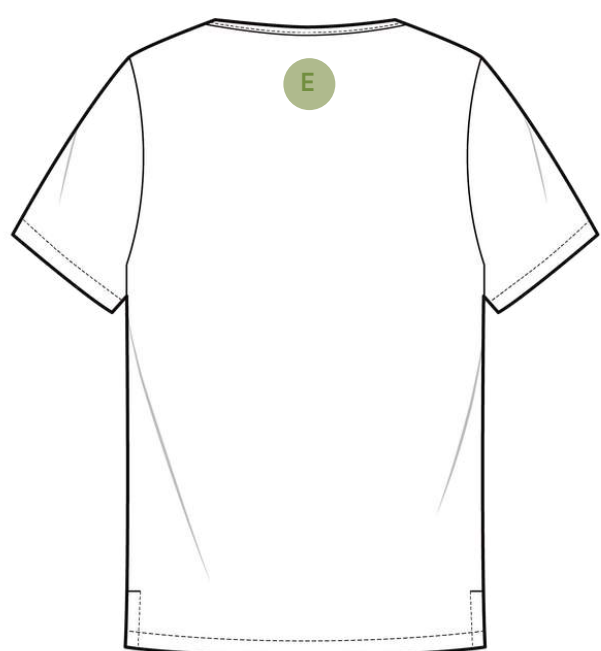

## BACK

Placement E: 9cm X 9cm

✓ Printing ✓ Embroidery



# Follow us!

---

 @greenchef.global @greenchefmy

 @greenchef.global @greenchefmy

---