



P00001223 OMNIFLEX™ ASSEMBLY INSTRUCTIONS

ACI Brands Inc., 2616 Sheridan Garden Dr., Oakville, ON L6J 7Z2
TEL: 1.800.668.5593

AD07515-P00001223-0820

P00001223
AD07515-P00001223-0820

PRODUCT OVERVIEW

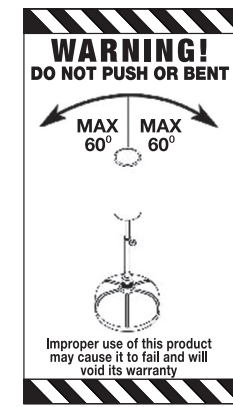
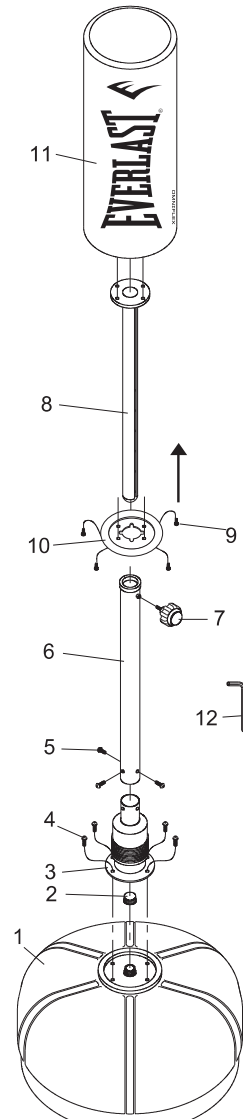

PARTS LIST:		
1. (1) Base	5. (3) Screw 5/16in x 12mm	10. (1) Disk
2. (1) Cap	6. (1) Lower Support	11. (1) Striking Bag
3. (1) Omniflex Neck	7. (1) Lock Knob	12. (1) Allen Wrench
4. (4) Bolt 3/8in x 25mm	8. (1) Upper Support	All tools required for assembly included
	9. (4) Bolt 3/8in x 25mm	

STEP 1.

Open the Cap (2.) on Base (1.) and fill with water or sand. Then close the Cap (2.) as shown in Figures A&B.

STEP 2.

Assemble Neck (3.) onto the Base (1.) with four bolts 3/8 in x 25mm (4.) as shown in Figure C. Remove three screws 5/16in x 12mm (5.) from the Neck (3.), then slide the Lower Support (6.) onto the top of the Neck (3.) and re-insert the screws to assemble Neck (3.) as shown in Figure C.

STEP 3.

Slide the Disk (10.) through the tube of Upper Support (8.), then screw both the Disk (10.) and Upper Support (8.) to the Strike Bag (11.) with four bolts 3/8in x 25mm (9.) fitted as shown in Figure D.

STEP 4.

Loosen the Lock Knob (7.) first, insert the Upper Support (8.) into the Lower Support (6.). Adjust the height and re-tighten Lock Knob (7.) to complete assembly as shown in Figure E.

Figure A

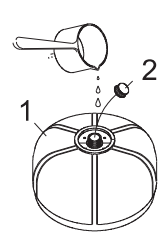

Figure B

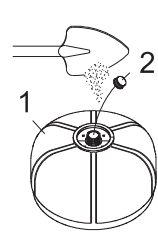

Figure C

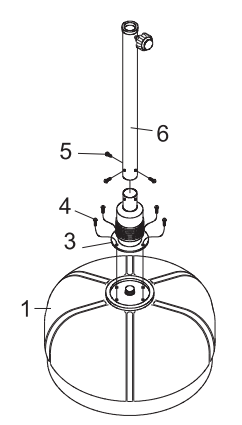

Figure D

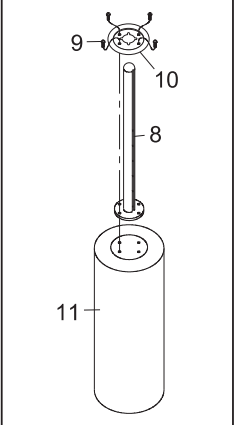
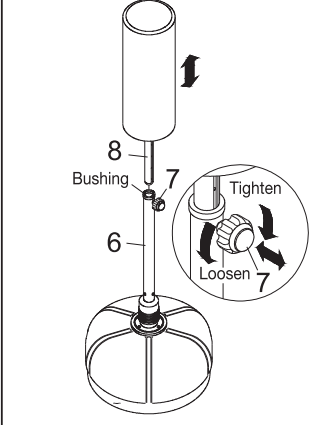

Figure E



P00001223 OMNIFLEX™ INSTRUCTIONS D'ASSEMBLAGE

ACI Brands Inc., 2616 Sheridan Garden Dr., Oakville, ON L6J 7Z2
TEL: 1.800.668.5593

AD07515-P00001223-0820

P00001223
AD07515-P00001223-0820

VUE D'ENSEMBLE DU PRODUIT

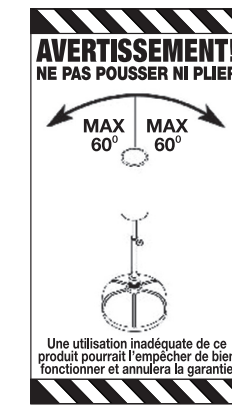
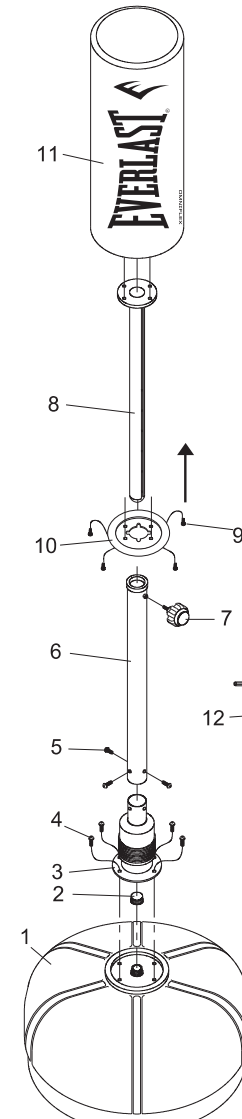

LISTE DES PIÈCES :		
1. (1) Base	5. (3) Vis 5/16 po x 12 mm	10. (1) Disque
2. (1) Bouchon	6. (1) Support inférieur	11. (1) Sac de frappe
3. (1) Tige Omniflex	7. (1) Poignée de verrouillage	12. (1) Clé hexagonale
4. (4) Boulon 3/8 po x 25 mm	8. (1) Support supérieur	Tous les outils nécessaires à l'assemblage sont fournis
	9. (4) Boulon 3/8 po x 25 mm	

ÉTAPE 1.

Ouvrir le bouchon (2) sur la base (1) et la remplir d'eau ou de sable. Puis refermer le bouchon (2) comme montré sur les Figures A et B.

ÉTAPE 2.

Fixer la tige (3) dans la base (1) avec quatre boulons 3/8 po x 25 mm (4) comme montré sur la Figure C. Retirer trois vis 5/16 po x 12 mm (5) de la tige (3), puis glisser le support inférieur (6) en haut de la tige (3), puis assembler la tige (3), comme montré sur la Figure C.

ÉTAPE 3.

Glisser le disque (10) dans le tube du support supérieur (8), puis visser le disque (10) et le support supérieur (8) au sac de frappe (11) avec quatre boulons 3/8 po x 25 mm (9) comme montré sur la Figure D.

ÉTAPE 4.

Desserrer la poignée de verrouillage (7) en premier, puis insérer le support supérieur (8) dans le support inférieur (6). Ajuster la hauteur et resserrer la poignée de verrouillage (7) pour terminer l'assemblage, comme montré sur la Figure E.

Figure A

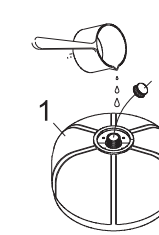

Figure B

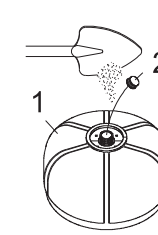

Figure C

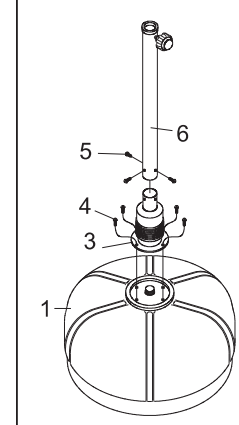

Figure D

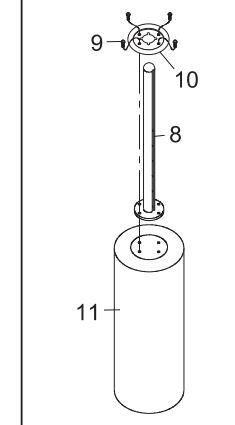
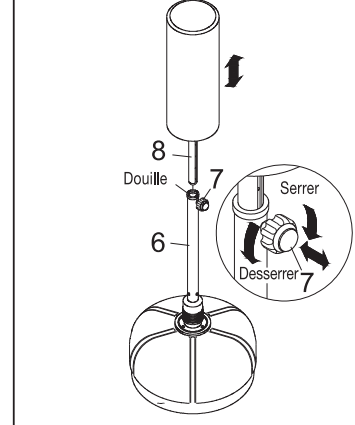

Figure E



FOR ANY PROBLEMS OR RETURN ISSUES PLEASE CALL 1-800-821-7930 FOR CONSUMER USE ONLY

GO TO EVERLAST.CA FOR MORE PRODUCTS

POUR TOUT PROBLÈME OU RETOUR, VEUILLÉZ APPELER LE 1-800-668-5593.
POUR USAGE DU CONSOMMATEUR UNIQUEMENT

CONSULTER EVERLAST.CA POUR DAVANTAGE DE PRODUITS