

Whisper Lift II Owner's Manual



**PREMIUM
ELECTRIC FIREPLACES
& TV LIFTS**

Exceeding Expectations

Table of Contents

Lift Features	5
Dimensional Drawing	6
Safety	7
IMPORTANT SAFETY and PRE-INSTALLATION INSTRUCTIONS	7
Lift Components & TV Installation Hardware	8
Components	8
Hardware	8
Tools	8
Assembling Your Whisper Lift II	9
Adjusting Lift Mounting Supports	9
Installing Crossbrackets on TV Lift	10
Fasten Lift To Cabinet	12
Setup and Operating the Whisper Lift II	13
Connect Lift Control Box and Power Supply	13
Installing Control Box	13
Attach Lift Cable To Control Box	13
Installing Wired Remote	13
Installing Power Supply Cable	14
Operating the Whisper Lift II	14
Initializing the Whisper Lift II	14
Operating the Wireless Remote	15
Operating the Wired Remote	15
Pairing Wireless Remote to Lift	16
Mounting and Installing the TV	17
Attaching TV Mounting Brackets to Flat Panel TV	17
Installing TV on Lift	19
Installing Locking Brackets on Whisper Lift II TV Lift	20
Optional Accessories	23
Add-On Component Shelf (optional)	23
IR Repeater Kit (optional)	29
Technical Support	30
Warranty	30

About Your Touchstone Whisper Lift II TV Lift

Congratulations on the purchase of your Touchstone Whisper Lift II TV lift. Touchstone Home Products takes pride in the quality craftsmanship and smooth functionality of our TV lift mechanism. Please take a few minutes to learn about the features of your TV lift to ensure you get the optimum use and performance from your new purchase.

Lift Features

- Durable steel construction with 24v motor for smooth, quiet and reliable operation
- Lift cycle fully raises or lowers in approximately 30 seconds.
- Universal quick connect installation takes just minutes. Includes hardware kit with bolts for mounting TV.
- 3-way adjustable mounting system to ensure that the Whisper Lift II is compatible with almost all flat panel TVs in the market today.
- Modular design – all components can be easily replaced in just minutes
- Optional component shelf
- 5 year worry-free warranty

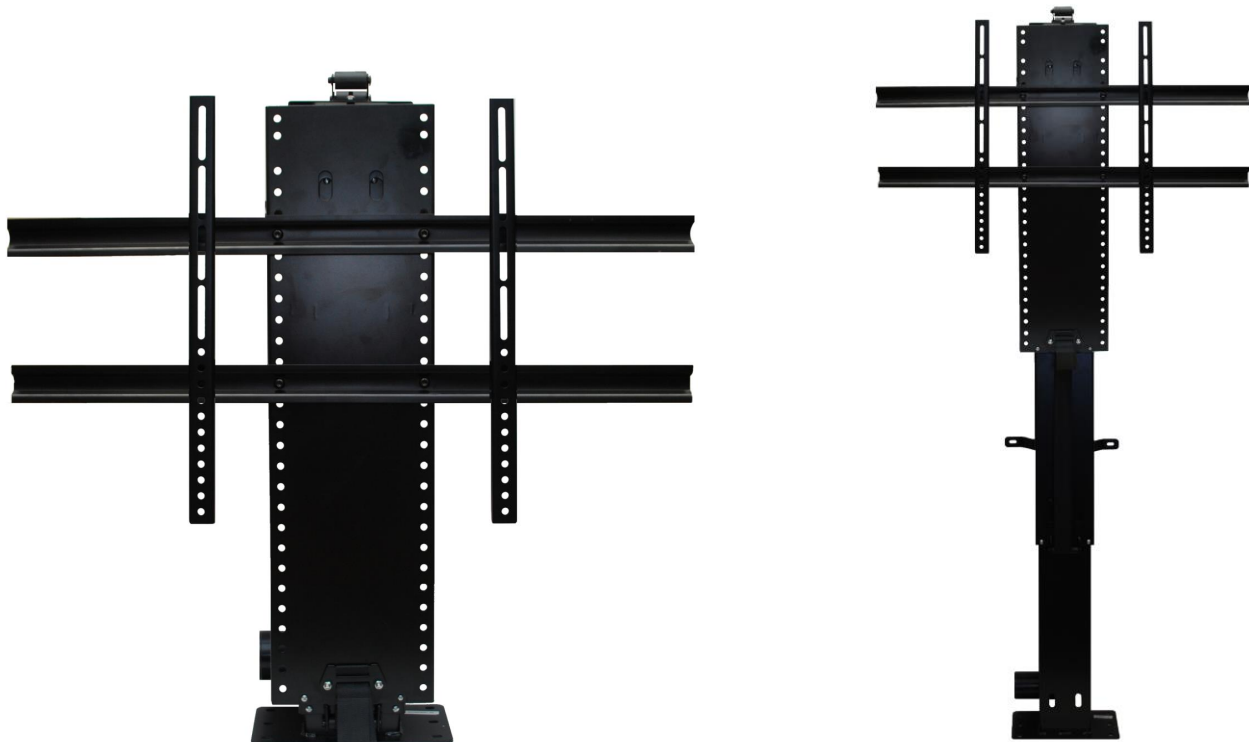

Dimensional Drawing

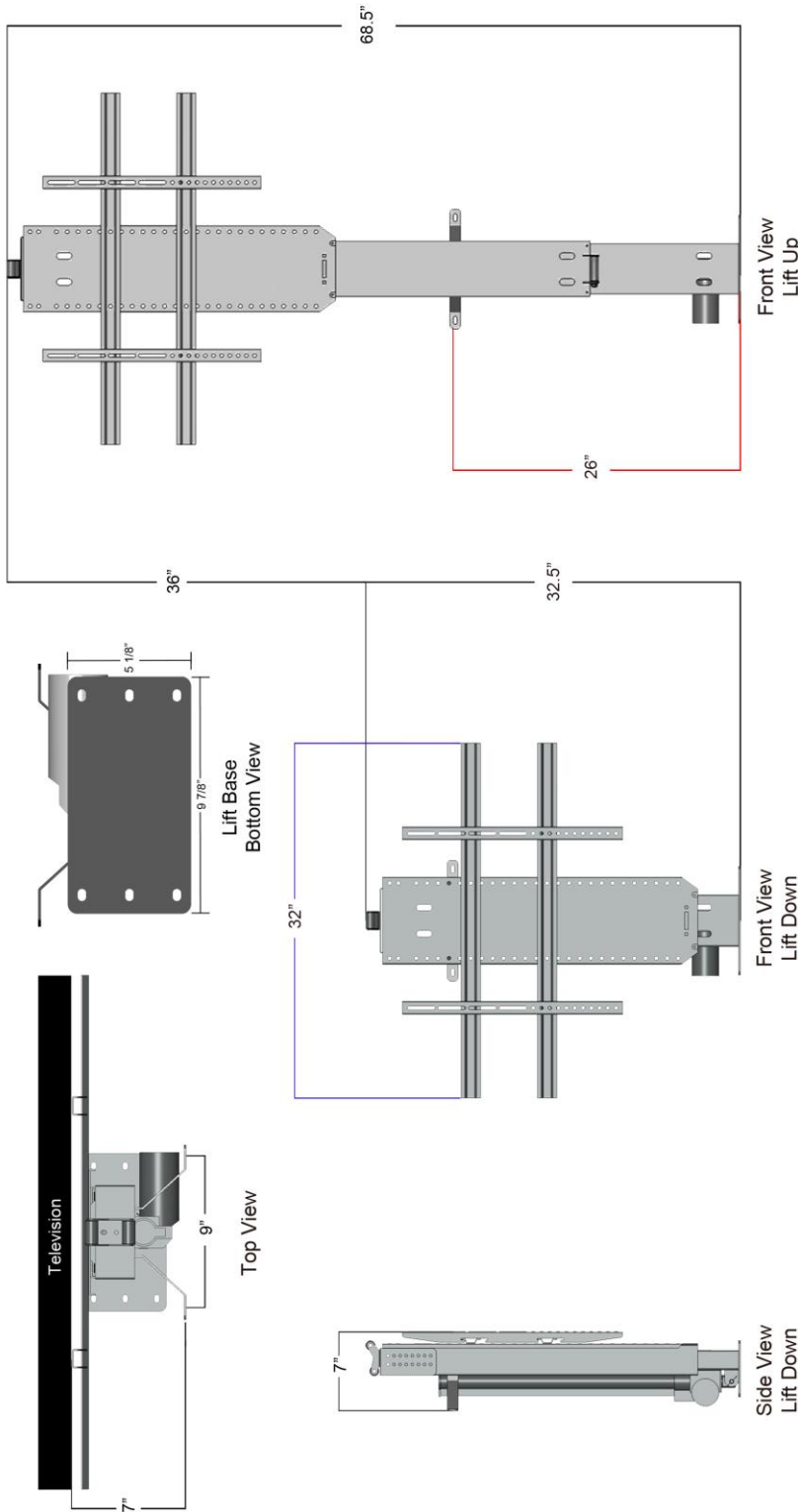

23202 - Whisper Lift II Features:

- Roller system for hinged lids
- Flat top for connected lids (31" high without roller)
- 100lb weight capacity
- Mounts to the floor and back
- Universal TV mounting brackets included
- Minimum cabinet TV cavity dimensions:
 height: 32.5"
 depth: 7" plus TV depth
 width: TV width + 1"
- 36" of stroke (works with TVs up to 36" tall w/o stand)
- Can be used in drop down applications

Whisper Lift II Dimensions
 PN: 23202



**PREMIUM
 ELECTRIC FIREPLACES
 & TV LIFTS**
 Exceeding Expectations

Safety

Mounting your flat screen TV to the Touchstone Whisper Lift II TV lift is fast and easy. Operating your lift is very straightforward. However, to avoid the risk of personal injury and to ensure optimum performance of your TV lift mechanism, please pay particular attention to the warnings and safety notices throughout this manual.

IMPORTANT SAFETY and PRE-INSTALLATION INSTRUCTIONS

1. Please adhere to the proper installation procedure as detailed in the installation instructions.
2. Safety precaution measures must be practiced at all times during installation of this product.
3. The entire installation instructions should be fully read and understood before beginning installation.
4. At least two people should be available to lift the TV onto the lift mechanism. Please take care when handling your flat screen TV, as injury and damage can result from dropping or mishandling of the TV.
5. Plasma screen TVs should remain upright at all times. Never place the screen face down on the floor. This could cause damage to the TV.
6. **The stand on your flat screen TV is removable!** Please remove the stand prior to installing the TV on the lift mechanism. Consult your TV's owner's manual for instructions for removing the stand.
7. Carefully measure all dimensions of your LCD, PLASMA, or LED TV before proceeding. Then consult the **Mounting and Installing the TV** section of this manual for maximum TV size.

IMPORTANT!: After installing your TV, you may find there is room in the bottom of the cabinet to install a small cable/satellite TV box. Carefully inspect the space between the bottom of the TV and the bottom of the cabinet to see if your component will fit in the bottom of the cabinet. Consult the **Mounting and Installing the TV** section of this manual for more information.

8. All cords connecting components to the TV should be a minimum of 72" (6 feet) in length when installing components inside of a cabinet or a minimum of 144" (12 feet) in length when installing components outside of cabinet (length of cable will depend on placement of your component).
9. **WARNING!:** TV lift mechanism contains moving parts. Please keep hands, arms, and fingers away from the lift and cabinet lid opening when the lift is in motion. Cables should be wire-tied or secured neatly so lift does not contact them during operation. Also, keep all components away from the lift mechanism.

Contact Touchstone Customer Service at 1-800-215-1990 with any questions regarding the operation of your Whisper Lift II TV Lift. We are also available on the web at www.touchstonehomeproducts.com

Lift Components & TV Installation Hardware

Components



Hardware

- TV Mounting Screws

-> Please consult your TV manufacturer for the size and length of the mounting screw for your TV. Included is a basic set of mounting screws that accommodates most LCD/Plasma TVs. Depending on your television, the screws included in the kit may not fit your television. If that is the case, these screws can be purchased at most hardware/home improvement stores.

Tools

In order to assemble the Whisper Lift II, you will need the following tools:

- Philips-head screwdriver
- size 4 metric hex wrench
- size 5 metric hex wrench
- adjustable wrench or size 4 and size 5 metric socket wrench

Assembling Your Whisper Lift II

Adjusting Lift Mounting Supports

Tools Needed:

- adjustable wrench

Instructions:

The Whisper Lift II ships with 2 mounting brackets pre-installed on the back of the lift as shown in the picture below:



Typically, these brackets do not require any adjusting by the customer. Should you need to adjust these brackets to level the lift, loosen the nuts holding the bracket to the lift and move the bracket accordingly.

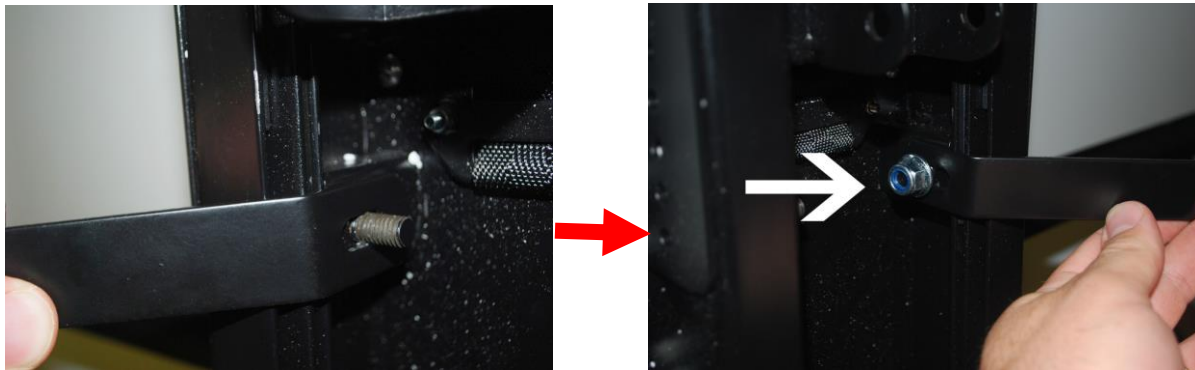

Once adjusted, the lift is ready for installation.

Installing Crossbrackets on TV Lift

Tools Needed:

- adjustable wrench
- size 5 metric hex wrench

Parts Needed During This Step:

- TV Lift
- 2 cross brackets
- 4 large hex screws- size 5
- 4 large lock nuts

Instructions:

1. Gather the 2 long crossbrackets, 4 large hex screws, and 4 large lock nuts.

Note: The 4 large hex screws and 4 large lock nuts will be attached to the lift.

2. Mount the top crossbracket in the 6th set of holes from the top of the lift. Use 2 large hex screws and 2 lock nuts to secure the crossbracket to the lift.



Installing Crossbrackets on TV Lift – cont

3. Mount the bottom crossbracket 7 holes down from the top crossbracket. Use the remaining 2 large hex screws and 2 lock nuts to secure the crossbracket to the lift.

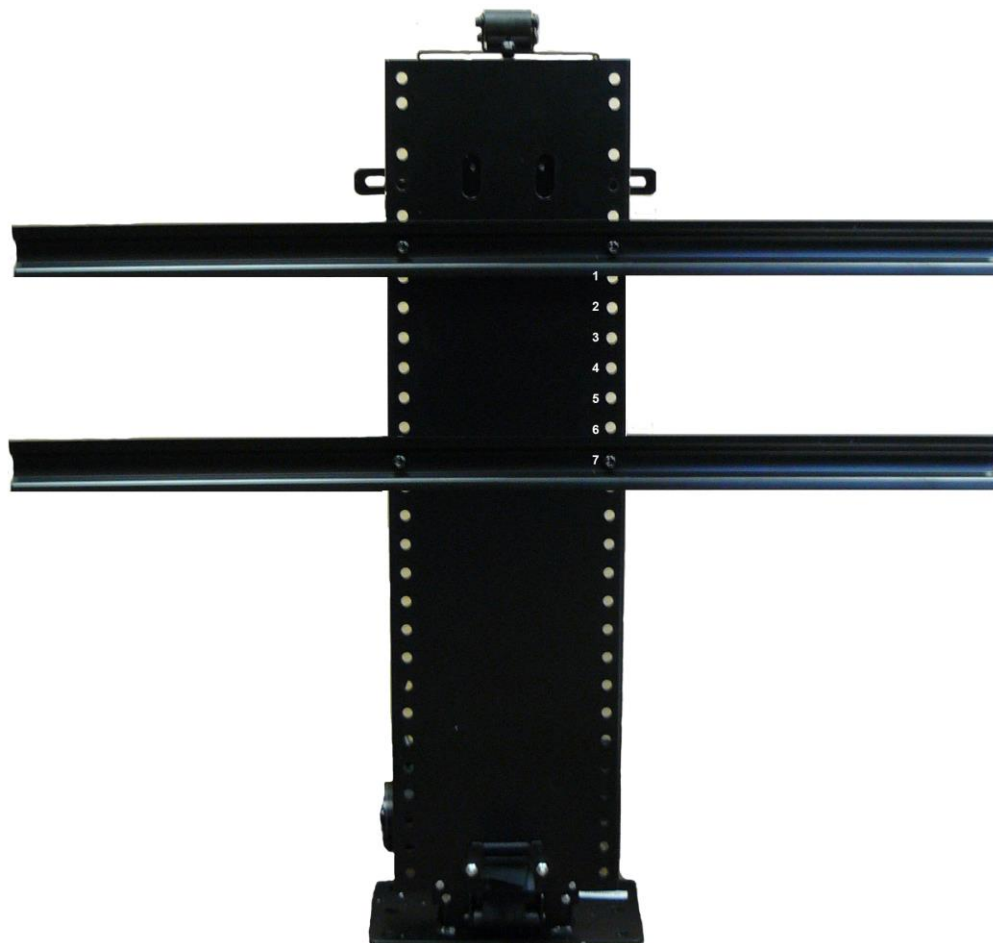

**NOTE: Make sure that the brackets are secured tightly to the lift prior to operation.

Fasten Lift To Cabinet

Parts Needed:

The Whisper Lift II TV Lift has 8 mount points (2 on the back of the lift and 6 on the floor). Use the rear 2 mount points and at least 4 of the 6 floor mount points to mount the lift in your cabinet.

Instructions:

1. Open cabinet lid and place lift in cabinet.
2. Align lift with mounting holes on floor and back wall of cabinet (fig A)
3. Using the wood screws (not provided), attach the lift to the cabinet, making sure the screws are tight and secure the lift.



Setup and Operating the Whisper Lift II

Connect Lift Control Box and Power Supply

Once you have installed your lift in the cabinet, it is time to connect the lift control box and power supply.

Parts Needed During This Step:

- Control box
- Power supply
- Wired remote

Installing Control Box

1. Remove the backing from the Velcro on the back of the control box.
2. Place control box on the floor or back wall of the cabinet, where it is easily accessible.



Whisper Lift II Control Box

Attach Lift Cable To Control Box

1. Attach the lift cable to the MOTOR port on the control box.

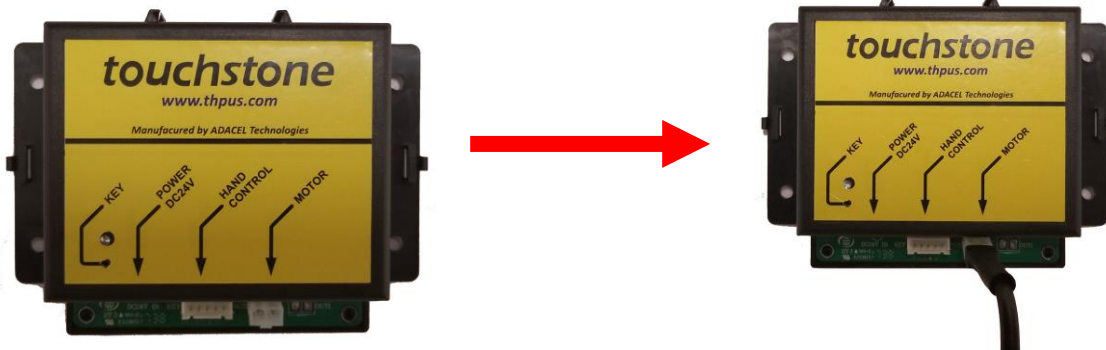

Installing Wired Remote

1. Remove the backing from the Velcro attached to the wired remote.
2. Place the wired remote in a location of your choosing on the wall on the inside of the cabinet.
3. Plug the cable for the wired remote into HAND CONTROL port in the control box.



Setup and Operating the Whisper Lift II – cont

Connect Lift Control Box and Power Supply – cont.

Installing Power Supply Cable

1. Remove the backing from the Velcro attached to the power supply.
2. Place the power supply in a location of your choosing in the bottom of the cabinet.
3. Attach the cable from the power supply to the power port on the control box and plug the power cable into the wall outlet.



Operating the Whisper Lift II

The Whisper Lift II TV Lift can be controlled via the wired remote control or the wireless remote control.

NOTE: Before operating the lift, the user must initialize the lift. Prior to running the initialization procedure, please be sure that the area above the lift is clear of any items that may obstruct the movement of the lift.

Initializing the Whisper Lift II

Before operating the lift, the lift needs to be initialized. To initialize the lift, please follow the procedure listed below:

1. Press and **HOLD** the UP and DOWN button on the wired remote control together at the same time until the red light on the top of the control box starts to flash.

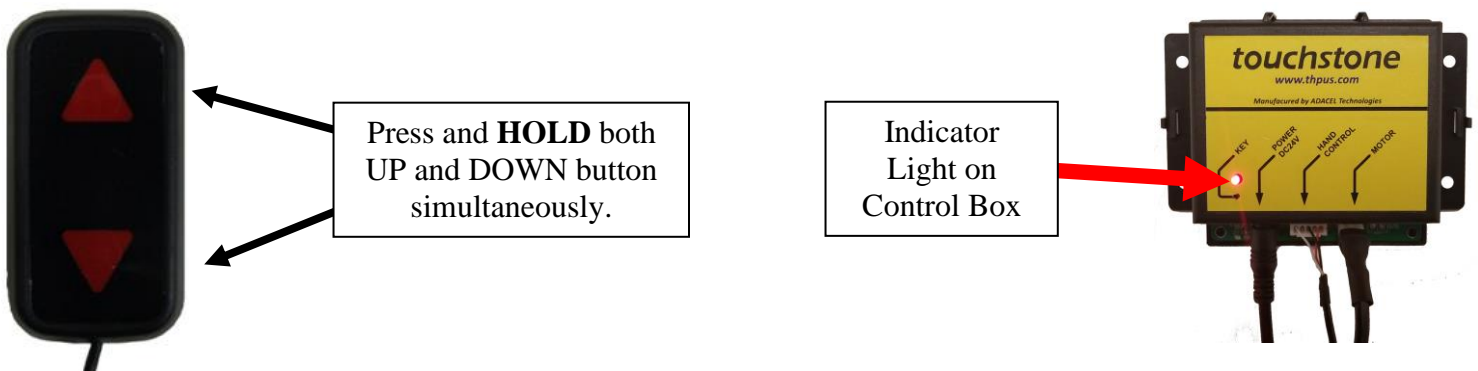

2. Release the UP and DOWN button and the indicator light on the top of the control box will flash 3 times and turn off. The lift will go all the way to the bottom, back up the top and all the way down to the bottom again. The red light on the control box will come back on when the initialization procedure is complete.

*****Note: Do not proceed until this procedure is complete.***

Setup and Operating the Whisper Lift II - cont

Operating the Wireless Remote

The remote control for your Touchstone Whisper Lift II is controlled via radio frequency. You do not need to point the remote control directly at the cabinet to operate the lift.

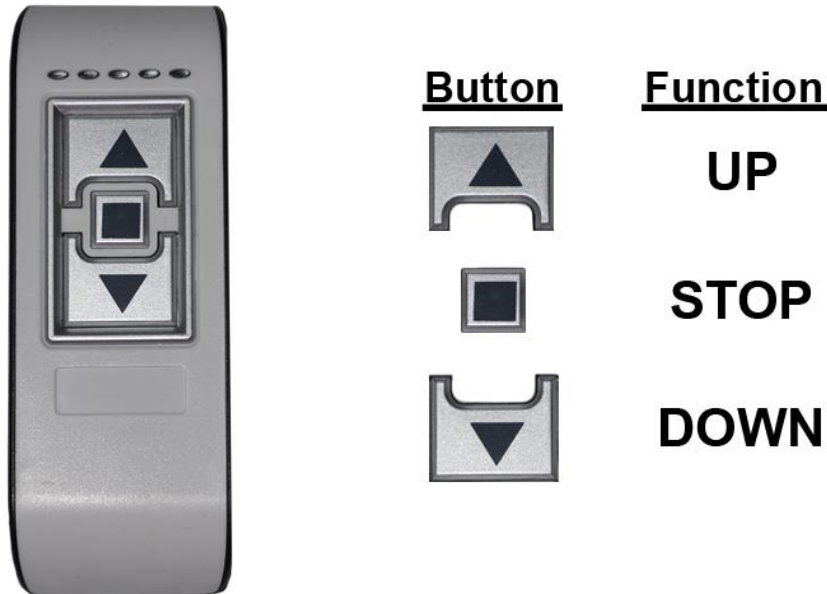

Operating the Wired Remote

A wired control is included with your Touchstone Whisper Lift II, which can be mounted inside of the cabinet and control the lift should you misplace the wireless remote control.



When installing the wired remote in the cabinet, the DOWN arrow points toward the wire and the UP arrow points away from the wire.

Setup and Operating the Whisper Lift II – cont

Pairing Wireless Remote to Lift

Tools Needed:

- Paper Clip

Instructions:

1. On the control box, there will be a hole to the right of the word KEY.



2. With a straightened out paper clip, push the paper clip into the hole and hold for 3 seconds until the indicator light on the control box turns OFF.

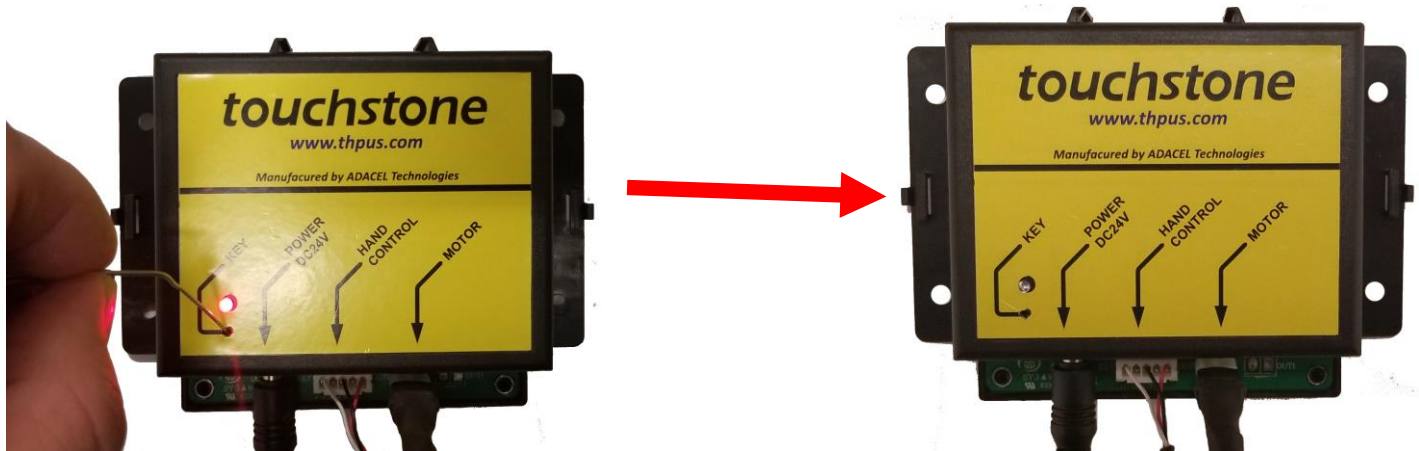

3. Press any button (UP, DOWN, or STOP) on the WIRELESS REMOTE to pair the remote control to the control box. If you are successful, the red light on the control box will flash 3 times and turn ON solid RED. The wireless remote control is now paired to the lift.

Mounting and Installing the TV

IMPORTANT: Prior to installing the TV onto the lift, please ensure the following:

- If you have not done so already, remove the stand from your flat screen TV.
- TV weight needs to be under 100lbs.
- TV has VESA compliant mounting pattern.

Attaching TV Mounting Brackets to Flat Panel TV

Tools Required

- Phillips head screwdriver

Parts Required

- TV mounting brackets
- TV mounting screws

***Note: Touchstone Home Products includes a screw pack containing some of the most popular sizes of mounting screws, used by most TVs on the market. Due to the amount of TVs in the marketplace and no standard for mounting screw size, Touchstone Home Products cannot guarantee that the screws required for your TV are included in the screw pack. Please consult your TV manufacturer for the size of the mounting holes in the back of your TV and use the appropriate size screws. Touchstone Home Products assumes no liability for damage to a TV.

Instructions

1. Remove stand from TV. Consult TV manual for instructions on removing the stand from the TV.
2. Locate the TV mounting brackets. They are pictured below.



TV Mounting
Brackets

Attaching TV Mounting Brackets to Flat Panel TV- cont

3. Align TV mounting brackets so that brackets are centered on the back of the TV. Place the TV mounting bracket so that the slotted holes are toward the top of the TV, while the round holes are toward the bottom of the TV.

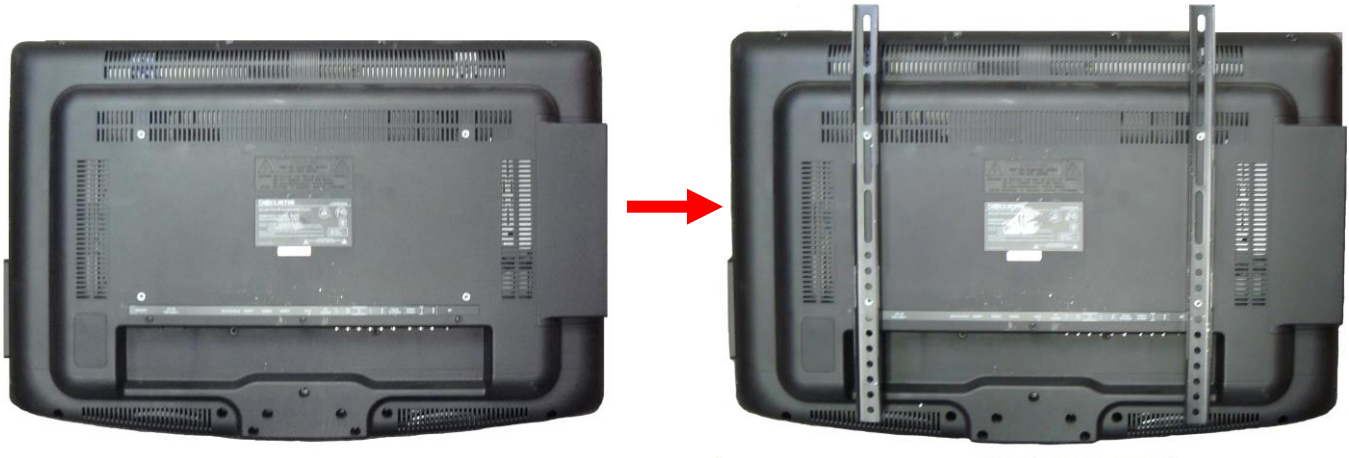

4. Attach TV mounting brackets to back of TV. Consult your TV owner's manual for the proper size mounting screw.



Installing TV on Lift

1. Using the internal wired control, move the lift to the up position. The UP button is the button opposite of the cable side of the wired remote.



2. Hang TV on top crossbracket.



3 With TV hanging on top crossbracket, slightly raise the TV (a) and push it back toward the lift (b) so that the bottom crossbracket is centered between the bottom set of hooks on the back of the TV mounting brackets.



4. Move the TV down slightly to fully attach TV to crossbrackets. The TV will hang on the top crossbracket and the upper set of hooks on the bottom of the TV mounting brackets will lock the TV in place from moving while on the lift.

****Please Note:** The top of the TV should be lower than the roller assembly on top of the lift. This will insure that the roller is the first thing to come in contact with the lid when the lift goes up.

Installing Locking Brackets on Whisper Lift II TV Lift

Tools Needed:

- Philips-head screwdriver

Instructions

1. Locate the bag with the Locking Bracket Kit included with your lift. In this bag, there will be 2 brackets and 2 philips-head screws.



2. Install the screw in each bracket so that the end opposite of the head of the screw is just slightly through the bracket.



Installing Locking Brackets on Whisper Lift II TV Lift – cont.

3. Place the larger end of the locking bracket into the slots in the TV mounting bracket just below the bottom cross bracket on the lift, as shown in the diagram below.



4. With a Philips-head screwdriver, tighten the screw so that the screw is tight against the cross bracket, as shown in the picture below.

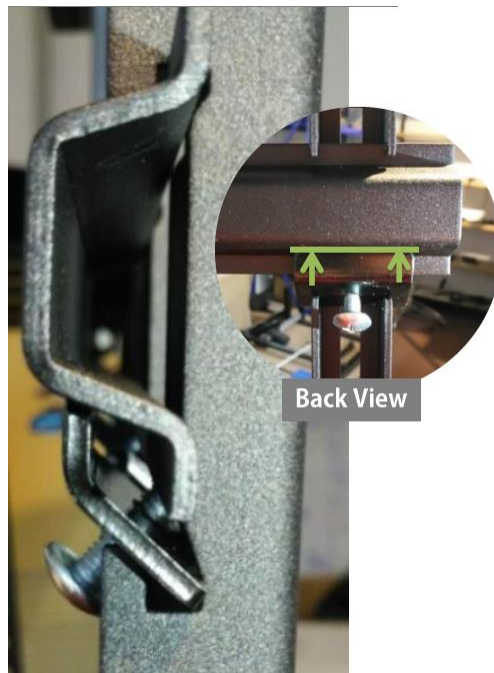

5. After installing the first locking bracket, install the 2nd locking bracket on the other TV bracket in the same manner. Your TV should now be locked in place and not move from side to side.

Setting Adjustable Roller Assembly

Each Whisper Lift II comes with an adjustable roller assembly that allows you to set the maximum height of the lift.

Tools Needed:

- none

Instructions:

1. Raise the lift to a height that is comfortable for you to work at.
2. The adjustable roller is held in place by 2 screws and wing nuts on either side of the lift. By hand, remove the 4 sets of screws and wing nuts.

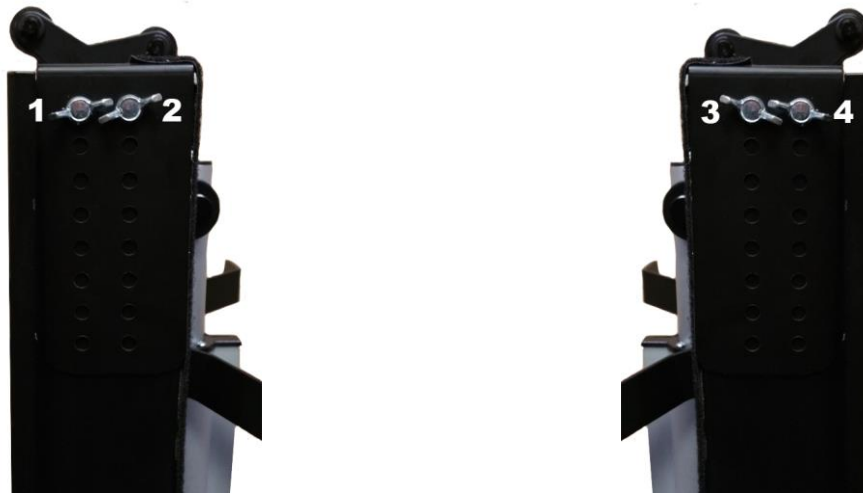

3. Raise the adjustable roller to the desired level and refasten the adjustable roller to the lift using the screws/nuts removed in step 2.
4. Adjust height of adjustable roller as needed so that lid of cabinet closes flush.

Optional Accessories

Add-On Component Shelf (optional)

Tools Needed:

- adjustable wrench
- size 5 metric hex wrench

Component Shelf Parts

- component shelf
- 2 shelf brackets
- 4 spacers
- 4 nuts and bolts

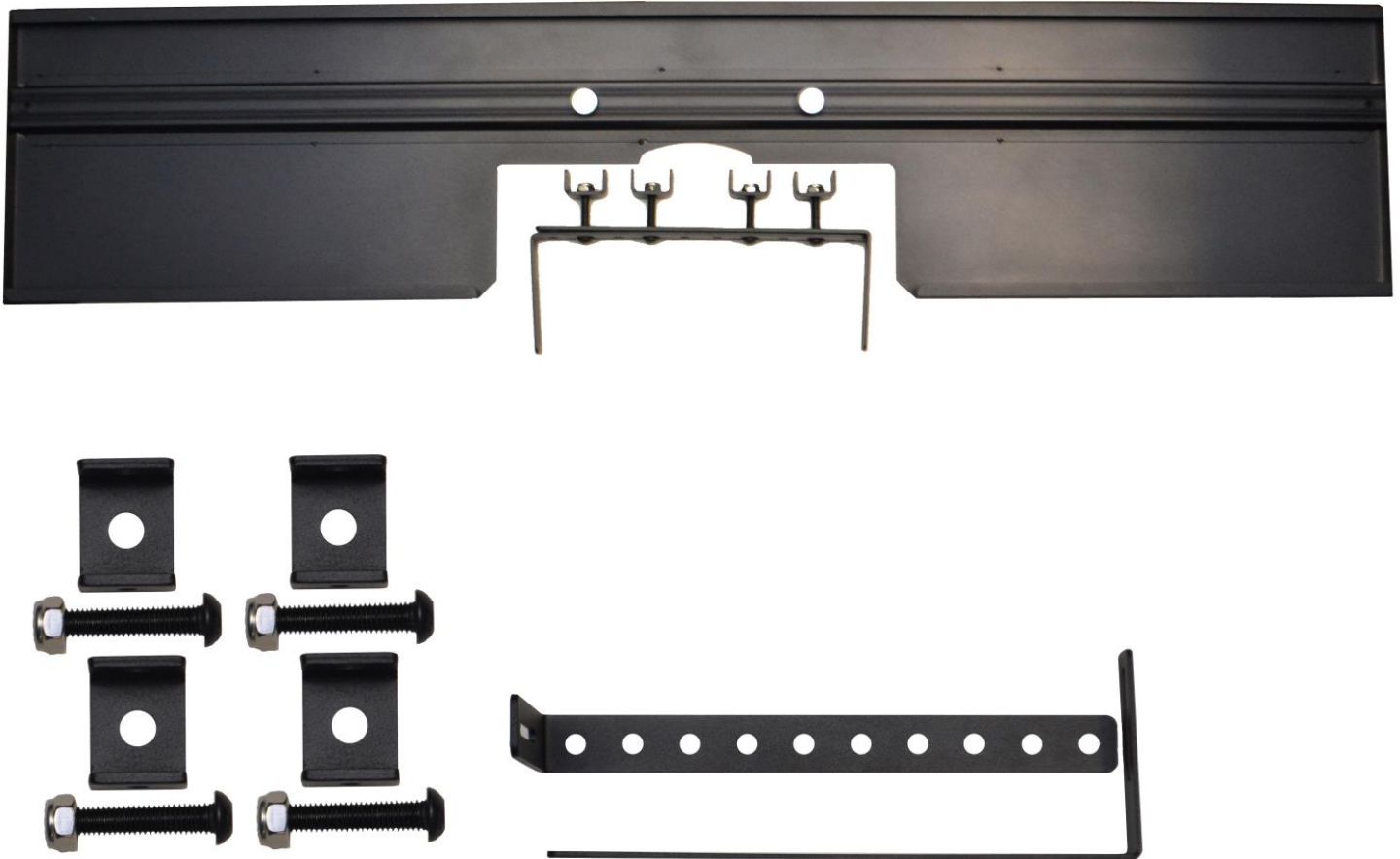

Assembly Instructions:

1. After unpacking the shelf, remove the 2 thumb screws from the bottom of the shelf.



Assembling Component Shelf – cont

2. Line up shorter end of shelf bracket with hole in bottom of shelf. The hole in the bracket is elongated for adjustment of shelf depth.



3. Install both shelf brackets by attaching the 2 thumb screws removed from the shelf in step 1.



Assembling Component Shelf – cont

4. Once both brackets are installed, use an adjustable wrench to tighten the screws so the brackets cannot move.



5. Once the shelf is assembled, attach the shelf to the lift. Line the vertical holes in the shelf brackets up with the vertical holes in the lift. Once aligned, install spacer in 2nd hole down from the top of the bracket, as shown below.

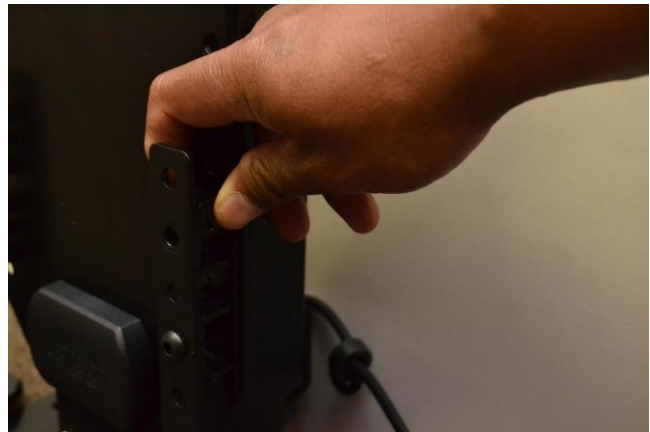
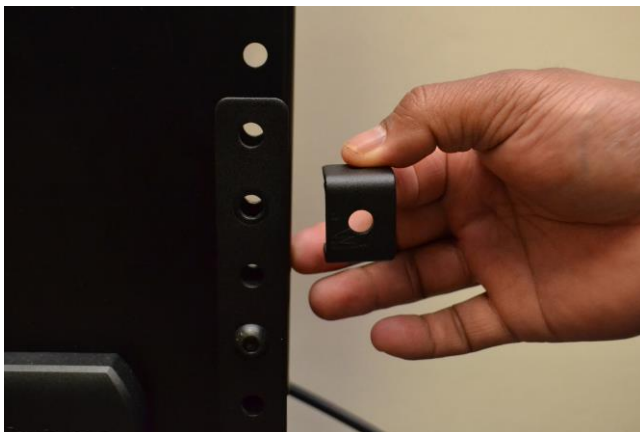

Assembling Component Shelf – cont

6. Once the spacer is lined up, install the nut and bolt to tighten the spacer to the lift. Use a size 5 metric hex head wrench and adjustable pliers to tighten the nut and bolts.



Thread bolt through bracket and spacer



Tighten bolt and nut

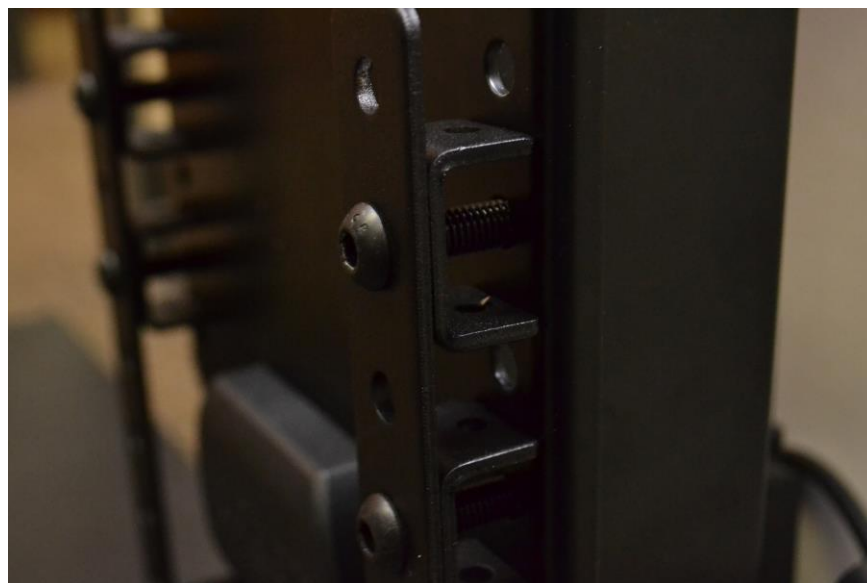

Spacer installed

Assembling Component Shelf – cont

7. Install all 4 spacers to attach the shelf to the lift. Once installed, the shelf is ready for use.

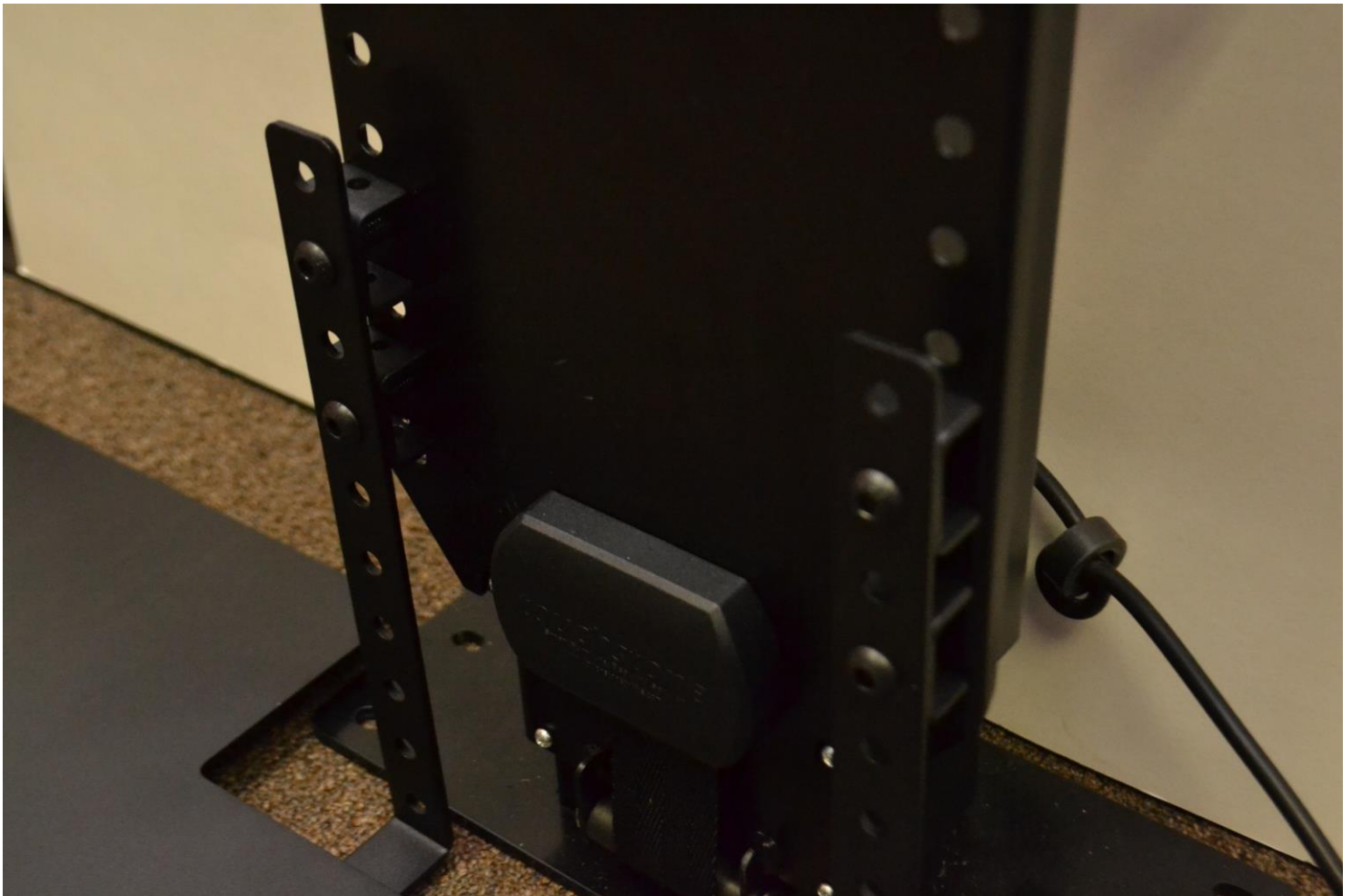

Shelf brackets installed.

******CAUTION: After attaching the component shelf to the lift, please check to ensure that the component shelf clears the front of the cabinet when lowered. Do not attempt to lower lift if it appears the shelf will hit the front of the cabinet. If the shelf does not clear the front of the cabinet, revert back to the Installing Lift In Elevate Cabinet section and check to make sure the shelf and lift are aligned.***

Assembling Component Shelf – cont

3. When completed, attach the component shelf to the lift using the 2 large hex bolts (E) and nuts provided.



Assembled Component Shelf



Component Shelf Attached to Lift

IR Repeater Kit (optional)

The Touchstone Infrared Repeater allows the customer to install a small satellite TV/cable box in the bottom of the cabinet. The Touchstone Infrared Repeater allows the user to change the channel on their cable box without having direct line of sight to the component.

For more information on the Touchstone Infrared Repeater Kit, please visit

<http://www.touchstonehomeproducts.com/irrepeaterkit.html> or call our Customer Service Department at 1-800-215-1990 for more information and pricing.

Technical Support

Should you have any problems with your Touchstone Home Products Whisper Lift II, our technical support staff is here to help. Our technical support reps are available for phone assistance at 1-800-215-1990 Monday to Friday, from 8:00am to 5:00pm EST. We also can be reached via email at support@touchstonehomeproducts.com

Warranty

Touchstone Home Products warrants the Whisper Lift II TV Lift to be free from defects in material and workmanship for five years from date of purchase. The warranty includes all parts, motorized components, electronics, and metal. If the Whisper Lift II proves to be defective in material or workmanship during the warranty period, Touchstone Home Products will replace the defective part free of charge. The replacement part will then be covered by the balance of the time remaining on the customer's original warranty.

Touchstone Home Products' warranty does NOT cover: any product on which the serial number has been defaced, modified or removed; damage, deterioration or malfunction resulting from accident, misuse, neglect, power surges, fire, water, lighting, or other acts of nature, unauthorized product modification, failure to follow instructions supplied with the product, repair or attempted repair by anyone not authorized by Touchstone Home Products, causes external damage to the product such as electric power fluctuations or failure, use of supplies or parts not meeting Touchstone Home Products specifications, or any other cause which does not relate to a product defect.

 **CALL US FIRST!** 
DO NOT RETURN TO STORE.

For immediate help with assembly, product information,
or if your product arrives damaged, call our toll-free number at

800-215-1990

or email:

customerservice@thpus.com

Our staff is ready to provide assistance.