



inquiry@hykolity.com

www.hykolity.com

+1 (562) 456-0507



Ship Series 4FT LED Vapor Tight Light

BRIGHT

TRUSTED

HIGH-QUALITY

LED Vapor Tight Fixture Ship Series



40W	Adjust color and power of light with integrated switch	4000K
50W		5000K
60W		6000K



SUITABLE FOR
WET
LOCATIONS



DIMENSION:(mm/in)

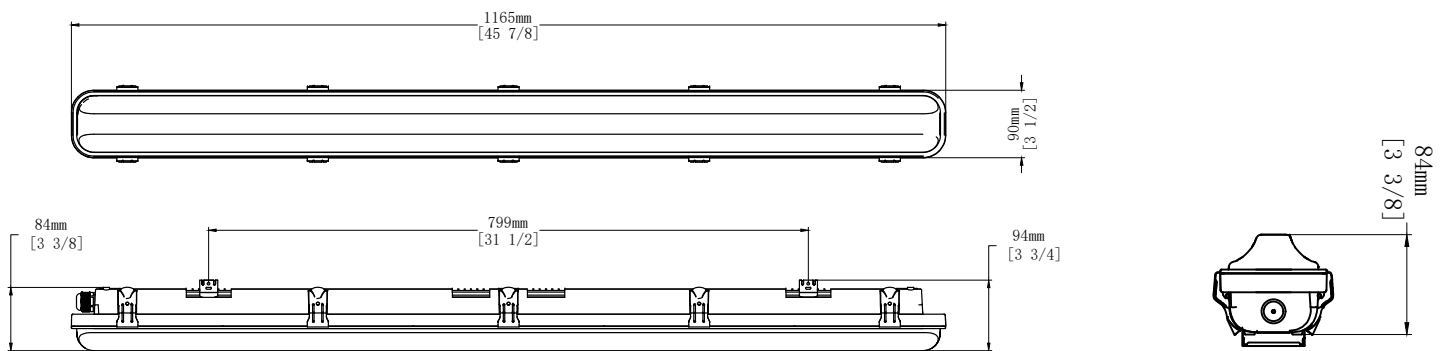

LED Vapor Tight Fixture Ship Series



FEATURES

- 3CCT Selectable; Power Selectable;
- ETL/cETL listed for wet locations.
- Higher efficiency,
- 130 lumens per watt (Frosted Lens);
- 120-277VAC universal voltage
- Work Temperature: -40°F to 122°F
- 0-10V dimming standard
- Easy Installation

APPLICATIONS

Wet areas, Outside walkways, Warehouses, Storage areas, Industrial units, Farm buildings (Non-corrosive atmosphere), Garages, Workshops, Car parks, Changing rooms, Resistant to impact and many chemical agents, but for suitability in specific environments please take specialist advice.



Supermarket



Farm buildings



Parking lot lighting



Warehouses



The light transmittance of PC cover is up to 92%. The integrated design of Lens Cover and LED Plate is more convenient to install and use.

The mount brackets keep adjustable space for easy correction.



INSTALLATION

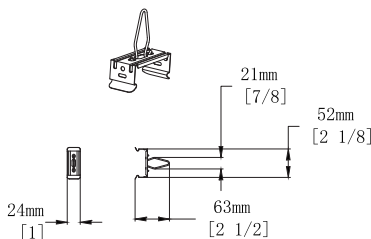

Hoisting Installation

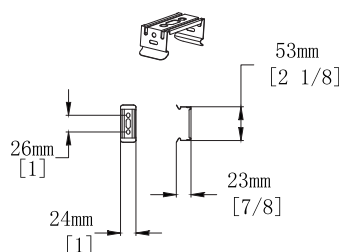

Ceiling Installation

LED Vapor Tight Fixture Ship Series



3CCT Color Temperature

Choose your favorite color before installation.



Wattage Selectable

Get the benefits of **ONE** fixture **NINE** choices, it can be adjusted between three wattage levels and three color temperatures. You can easily customize the fixtures to fit your needs on site, which can help save time and money during the design process.

0-10V Dimmability

DC Voltage Varies between 0 up to 10v to create the lowest dimming levels and scale the output of your LED light.



LED Vapor Tight Fixture Ship Series



Code	Size	Input Voltage	CCT	Power	CRI	Efficiency	Beam Angle
VP60W5K-S-4S	1165*90*84mm	120-277VAC	4000K/5000K/6000K Selectable	40/50/60W Selectable	>80	130Lm/W	160°

INSTALLATION INSTRUCTIONS (1 / 2)

READ PRIOR TO ATTEMPTING INSTALLATION
ALWAYS TURN OFF MAIN POWER BEFORE INSTALLATION
INSTALLATION SHOULD BE CARRIED OUT BY YOUR LOCAL ELECTRICIAN

!WARNING - Risk of fire or electric shock. LED Kit installation requires knowledge of luminaires electrical systems. Pls contact a qualified electrician to install it if you are not qualified.

!WARNING - Risk of fire or electric shock. Install this kit only in luminaires that have the construction features and dimensions shown in the photographs./ The input rating of the retrofit kit does not exceed the input rating of the luminaire.

!WARNING - To prevent wiring damage or abrasion, do not expose wiring to edges of sheet metal or other sharp objects.

!WARNING -This equipment is intended to be installed only by qualified personnel. The installation must be made in accordance with the current edition to the National Electric Code and all applicable state and local building codes. The final installation must be approved by the appropriate qualified electrical/building inspector(s). Improper installation may result in a fire or electrical hazard. Be sure the electrical power to the circuit has been disconnected before installing this electrical system.

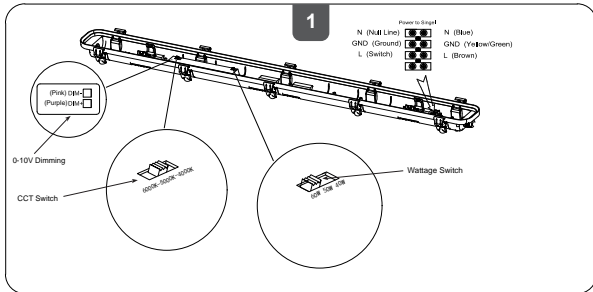

1. Color Temperature and Power needs to be selected before installation. This fixture has an optional 0-10V dimming function, if necessary, please wired according to the mark.

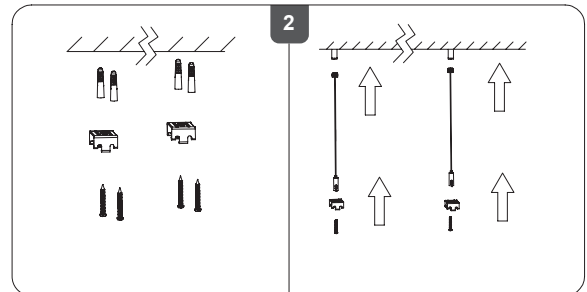

2. Identify installation location & check for any passing wiring/ piping prior drilling and installing cables. Fix the mounting brackets / suspension kits on the ceiling at correct spacing as per dimensions.(Pic.A)

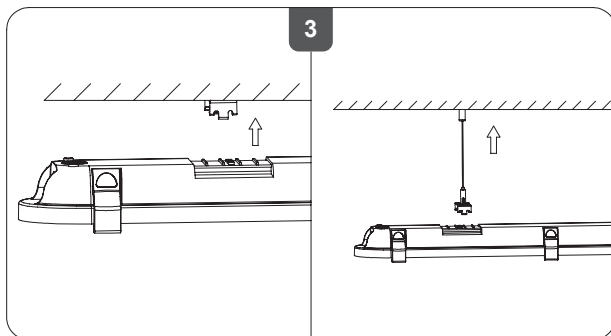

3. Position and fix base using the pre-fixed mounting brackets / suspension kits.

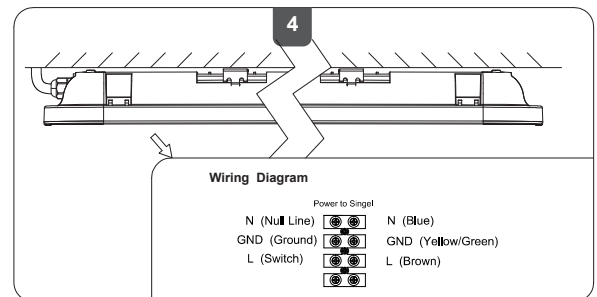

4. Connect the power cable accordingly.

LED Vapor Tight Fixture Ship Series

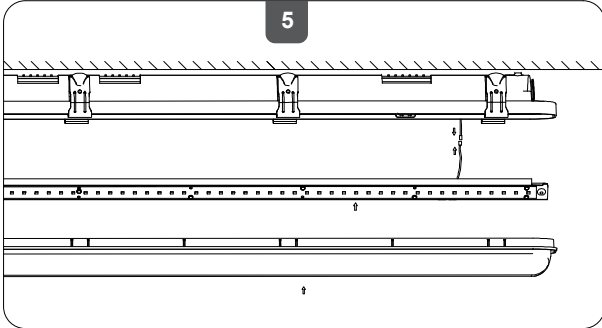

5. Connect the safety rope and male/female DC connectors. Check all connections are sound and properly insulated, then fit the tray back in the casing.

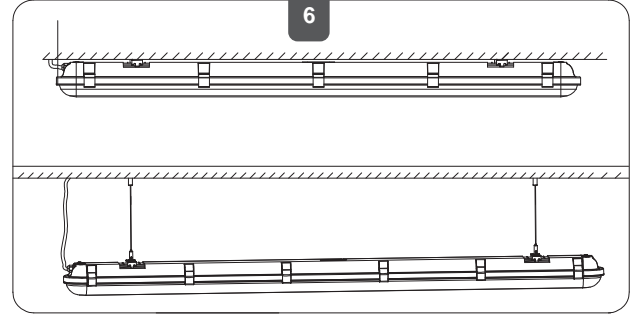

6. Re-fit the diffuser to the base and secure all the clips.

HARDWARE INCLUDED

NOTE: Hardware not shown to actual size.

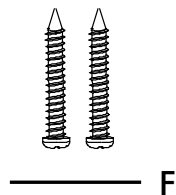
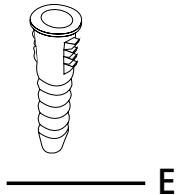
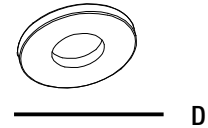
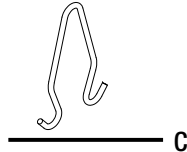
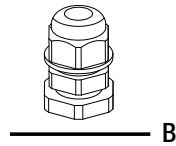
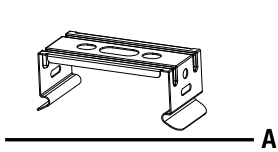

Part	Description	Quantity
A	Mounting Brackets / Suspension Kits	2
B	Waterproof Connector	1
C	Hook	2
D	Washers	4
E	Plastic Anchors	4
F	Anchor Screws	4