



QUICK START GUIDE

sodastream®
SPIRIT™

 Please read this Quick Start Guide before using the Sparkling Water Maker.



SMART

SodaStream is the new way to enjoy delicious bubbles without the bottles. No more lugging or storing heavy bottles! And fewer empty bottles or cans to discard or recycle. Better for you, better for the environment!



SIMPLE

Now you can simply turn tap water into fresh, fizzy sparkling water, soda and cocktails in seconds. Just fizz, mix and enjoy!



SPARKLING BEVERAGES

40+ great-tasting flavours to choose from. And you've just made the world a better place.

INSIDE THIS GUIDE

SPIRIT™ overview	3
What's Inside	3
Installing the CO ₂ Cylinder	4
Create the Bubbles	5
Flavour Your Way!	6
For your safety	7
Care	8
Troubleshooting	9
Warranty and Legal Information	10

SPIRIT™ OVERVIEW

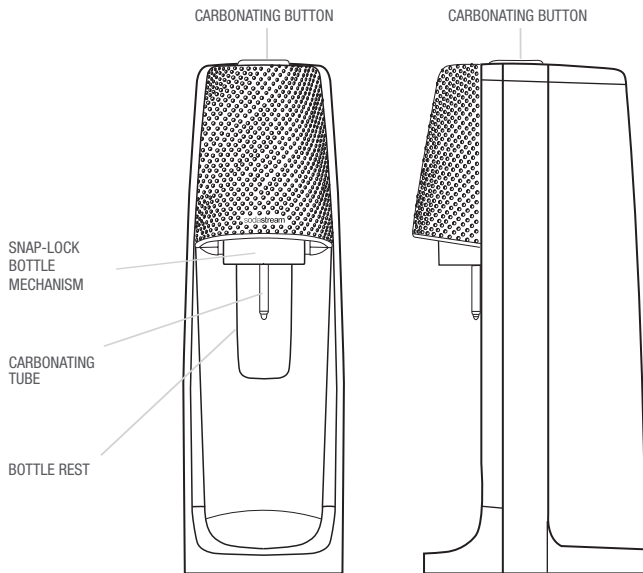

WHAT'S INSIDE

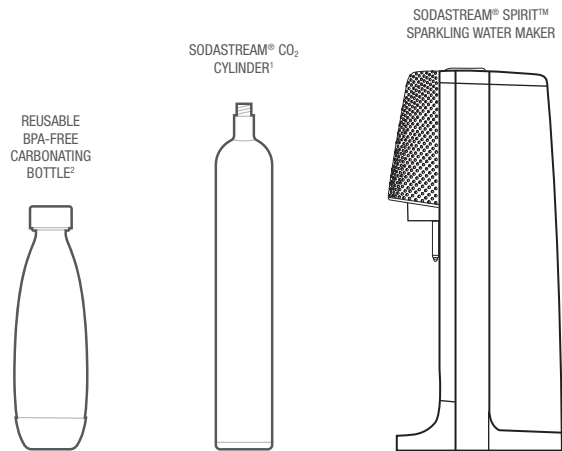

The package includes the SodaStream® SPIRIT™ Sparkling Water Maker, SodaStream® CO₂ Cylinder and a reusable BPA-Free carbonating bottle with fizz-preserving cap.

¹ Includes a 60 L SodaStream® CO₂ Cylinder (under licence). Once empty, the 60 L SodaStream® Cylinder can be exchanged for a full 60 L SodaStream® Cylinder for the price of the gas only. A 60 L SodaStream® Cylinder makes up to 60 L of sparkling water depending on the level of carbonation and type of Sparkling Water Maker used.

² Actual shape of bottle may differ. A dishwasher-safe carbonating bottle may be included and is identified by its 'Dishwasher-Safe' marking.

INSTALLING THE CO₂ CYLINDER

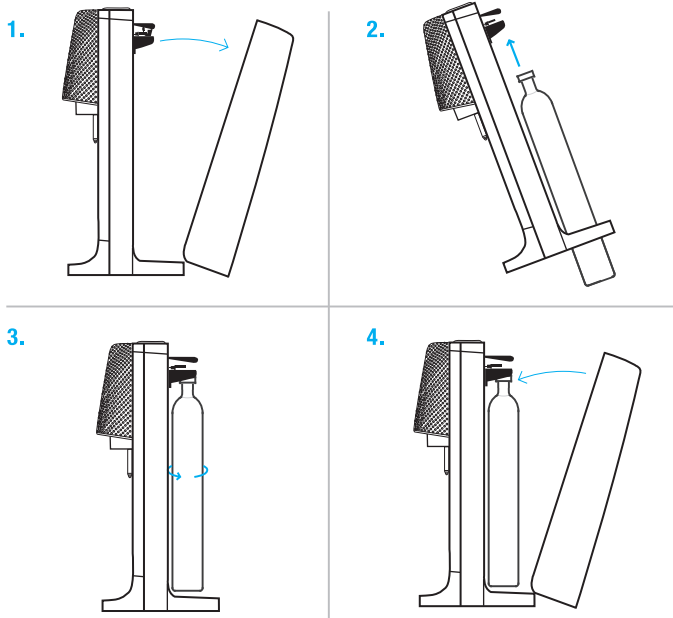

INSTALLING THE CO₂ CYLINDER

1. Place the SPIRIT™ Sparkling Water Maker on a flat sturdy surface in an upright position. Remove the back cover by pressing on the top of the back cover and pulling it away from the body of the Sparkling Water Maker. Set the back cover aside.
2. Remove seal and cap from the SodaStream CO₂ cylinder. Tip the Sparkling Water Maker forward and insert the cylinder through the hole in the base and upward to the cylinder holder at the top of the Sparkling Water Maker.
3. Return the Sparkling Water Maker to the upright position with the cylinder valve inside the cylinder holder. Screw the cylinder valve thread into the cylinder holder and twist. Hand-tighten only; DO NOT use tools.
4. Reinstall the back cover by fitting the upright tab at the bottom of the back cover into the slot at the rear of the base of the Sparkling Water Maker and pushing the cover into place onto the back of the Sparkling Water Maker. Now you are ready to create the bubbles.

CREATE THE BUBBLES

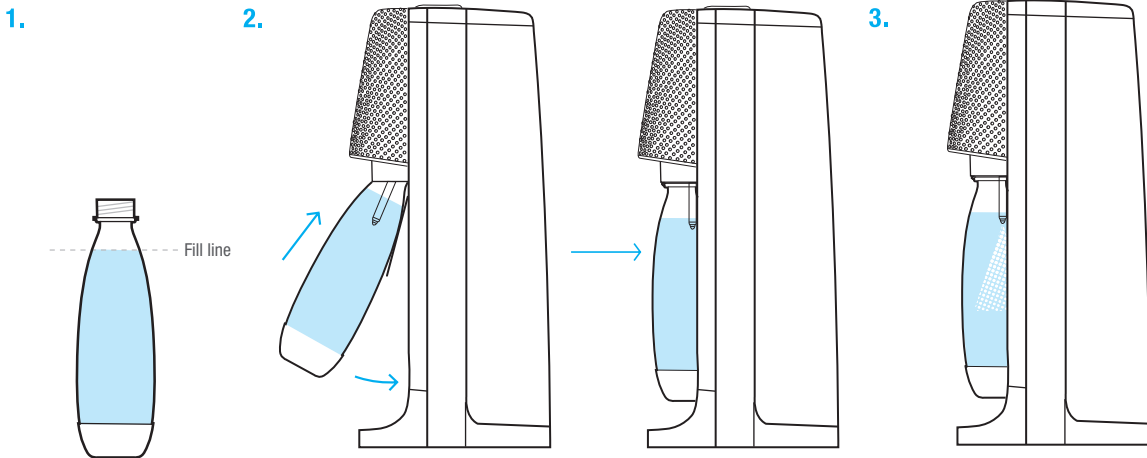

YOU MAY SEE SMALL
PIECES OF ICE APPEAR
IN THE WATER DURING
CARBONATION OF VERY
COLD WATER:

If this happens, shorten
the time of each press
until the ice stops
appearing otherwise
it can affect the
carbonation. Any ice
created will simply
melt.

1. Fill the carbonating bottle with cold water up to the fill line.
2. To insert the carbonating bottle, make sure that the bottle rest is angled forward. If it isn't, pull it towards you until it clicks. **Do not pull the carbonation tube.** Insert the carbonating bottle neck into the Snap-Lock. Push the bottle up and back. The Snap-Lock mechanism will catch the bottle and hold it in a vertical position suspended above the base.

3. Press the carbonating button all the way down with using short firm presses. You should hear a puffing sound after the third press. Three presses will create the normal level of carbonation. Additional presses will create a higher level of carbonation. It is normal to hear a puffing sound with each additional press.

CREATE THE BUBBLES

4.

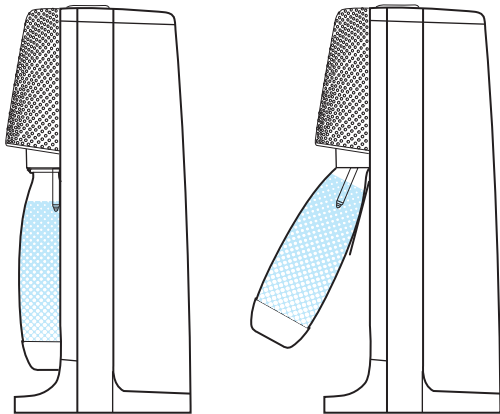

4. When the desired level of carbonation is achieved, gently pull the carbonating bottle towards you until it reaches its fully forward tilt position. This will release all the pressure in the bottle and allow the bottle to release itself from the Snap-Lock. Never pull the carbonating bottle out of the Snap-Lock: always allow the bottle to release itself. If the carbonating bottle does not immediately release from the Snap-Lock wait a few moments and it may release. If it still does not release, then push the bottle back into the vertical position and repeat the process to release it. Enjoy your sparkling water or add your preferred SodaStream Sparkling Drink Mix flavour to enjoy a sparkling flavoured beverage!

FLAVOUR YOUR WAY!

Sparkling Drink Mix

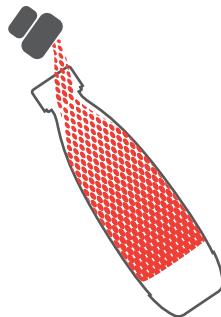

Enjoy!

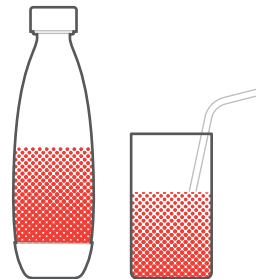

For sparkling drink mixes: After making sparkling water hold the open carbonating bottle **at an angle** and slowly add the desired flavour by pouring it slowly and carefully down the inside wall of the bottle. Close with the fizz-preserving cap and tighten, then mix with a gentle shake. Enjoy!

ONLY CARBONATE WATER . NEVER CARBONATE AFTER FLAVOUR HAS BEEN ADDED.

FOR YOUR SAFETY

SAVE THESE INSTRUCTIONS AND PROVIDE THEM TO ANY SUBSEQUENT USERS.

⚠ It is important that you read and understand all use and care instructions and the important safety information before using the Sparkling Water Maker to prevent personal injury and to prevent damage to your Sparkling Water Maker.

GENERAL WARNINGS:

- ⚠ **WARNING:** Misuse of your Sparkling Water Maker may result in serious personal injury.
- ⚠ **WARNING: DO NOT** use your Sparkling Water Maker if it is not in its upright position.
- ⚠ **WARNING: DO NOT** use your Sparkling Water Maker for anything other than carbonating water. Use of this Sparkling Water Maker for any unintended purposes may result in serious personal injury.
- ⚠ **WARNING:** Use your Sparkling Water Maker on a flat, stable surface away from heat sources and do not leave in direct sunlight.
- **DO NOT** place your Sparkling Water Maker on a hot surface (e.g. kitchen oven/stove/hob) and never use it close to a flame.
- The carbonating bottle must be properly in place before operating your Sparkling Water Maker.
- **DO NOT** move your Sparkling Water Maker during the carbonation process.
- **DO NOT** remove the carbonating bottle during the carbonation process.
- To reduce the risk of personal injury or property damage, any servicing or repair should be performed by a SodaStream-authorized service representative.
- Close adult supervision is necessary when your Sparkling Water Maker is used by children and it is not recommended for use by children under 12.

- Rinse the carbonating bottle with cold or lukewarm water before first use.
- ⚠ **WARNING:** ADD FLAVOUR ONLY AFTER CARBONATION.
- ⚠ **WARNING: DO NOT** carbonate into an empty bottle.

PLASTIC CARBONATING BOTTLE

- ⚠ **WARNING:** Unless the SodaStream carbonating bottle is identified by a prominent 'Dishwasher-Safe' marking, YOU SHOULD NEVER WASH IT IN THE DISHWASHER, NEVER WASH OR RINSE IT IN HOT WATER OR OTHERWISE EXPOSE IT TO HEAT ABOVE 50°C (120°F).
- ⚠ **WARNING:** These safety restrictions apply to both the regular and dishwasher-safe plastic carbonating bottles: **DO NOT** place the bottle next to a heat source such as your kitchen oven/stove/hob. **DO NOT** leave the bottle in your car. **DO NOT** place the bottle in the freezer or in extreme cold below 1°C (34°F). Doing so will compromise the integrity of the carbonating bottle material and may result in serious personal injury.
- ⚠ **WARNING: DO NOT** use a carbonating bottle if changes in shape have occurred, as that indicates the bottle is damaged. **DO NOT** use a carbonating bottle that is scratched, worn, discolored, or damaged in any way. Recycle or dispose of it and replace with a new one.
- ⚠ **WARNING:** SodaStream carbonating bottles are clearly marked with an expiration date near the bottom of the bottle. **DO NOT** use a carbonating bottle after its expiration date. Recycle or dispose of an expired bottle and replace with a new one.
- ⚠ **WARNING: DO NOT** carbonate with any bottle not specifically designed to work with this Sparkling Water Maker. Use only original SodaStream bottles.
- Fill the carbonating bottle with cold water only up to the fill line.

CARBON DIOXIDE (CO₂) CYLINDER

- **⚠ WARNING:** In the event of a CO₂ leak, ventilate the area, breathe fresh air and if feeling unwell seek immediate medical attention.
- **⚠ WARNING:** The cylinder and cylinder valve should be inspected prior to use for any dents, punctures, or other damage. If any are detected, **DO NOT** use the cylinder and contact a SodaStream-authorized service representative.
- **⚠ WARNING:** Mishandling the cylinder can result in serious personal injury.
- **⚠ WARNING:** Use caution when removing the cylinder as it may be very cold immediately after use. Always keep the cylinder away from any heat source and out of direct sunlight.
- **DO NOT** transport your Sparkling Water Maker with the cylinder in place.
- **DO NOT** tamper with the cylinder in any way.
- **DO NOT** attempt to puncture or incinerate the cylinder.
- **DO NOT** throw the cylinder or cause it to fall.
- **DO NOT** handle or remove a cylinder while it is discharging CO₂.
- **DO NOT** insert or replace the cylinder when a carbonating bottle is installed in the Sparkling Water Maker.

CARE

SPARKLING WATER MAKER

- Never use abrasive cleaners or sharp tools to clean. If needed, use a mild dish soap liquid and a soft damp cloth to gently clean.
- Wipe spills to keep base dry.
- **DO NOT** place in water or wash in a dishwasher. Doing so will seriously damage your Sparkling Water Maker.
- **DO NOT** place or store the Sparkling Water Maker close to a heat source.

CARBONATING BOTTLE

- Rinse carbonating bottles with cold or lukewarm water. Only carbonating bottles marked 'Dishwasher-Safe' may be rinsed with hot water.
- If needed, use a mild dish soap liquid and a soft bristled brush to clean.
- Replacement SodaStream carbonating bottles are available wherever SodaStream products are sold.

COMPATIBLE SODASTREAM CARBONATING BOTTLES



TROUBLESHOOTING

Before you call for service, please check the list of problems and solutions below:

SPARKLING WATER MAKER DOES NOT CARBONATE:

- You might be out of gas; replace your cylinder.
- Cylinder may be loose. Remove the carbonating bottle, open and remove the back cover to access the cylinder and retighten the cylinder by hand. **DO NOT** use tools. Apply firm pressure but do not over tighten. If the cylinder is already firmly in place, it may be empty. Replace with a full cylinder.
- Check that the carbonating bottle has been filled up with water to the fill line.
- Ensure that the Sparkling Water Maker is in the upright position.

CANNOT INSERT THE CARBONATING BOTTLE INTO THE SNAP-LOCK:

- Pull the bottle rest towards you until it clicks into its fully forward position. Insert bottle into Snap-Lock. Firmly push bottle up and back until it locks.

YOU HEAR GAS ESCAPING FROM THE CARBONATING BOTTLE:

- A slight of hissing of gas may be heard when the sparkling water maker is under pressure. This is quite normal and the noise will stop after carbonation when the bottle is tilted and the pressure is released.
- The carbonating bottle may not be properly attached. Allow the Sparkling Water Maker to finish the carbonation process and then you can detach the bottle and reconnect it. Follow the instructions in the 'Create the Bubbles' section.
- When carbonating, you should hear a puffing sound after the third press of the carbonating button as well as after each additional press, which is the sound of pressure being released.
- It is normal to hear a small amount of gas released at the end of the carbonation process.

WANT TO RE-CARBONATE A DRINK THAT WAS ALREADY CARBONATED:

- **⚠ WARNING:** FOR YOUR SAFETY, NEVER carbonate again after adding the flavour. You may only recarbonate unflavoured sparkling water.

YOUR SPARKLING WATER MAKER CONTINUES TO RELEASE GAS AFTER CARBONATION IS FINISHED:

- **⚠ WARNING:** Do not remove the cylinder or the bottle. Leave the Sparkling Water Maker in an upright position. Do not touch it until you no longer hear gas escaping. When the Sparkling Water Maker is no longer releasing gas, remove the carbonating bottle and contact your local SodaStream Customer Service Center.

- **⚠ WARNING:** In the event of a carbon dioxide leak, ventilate the area, breathe fresh air and if feeling unwell seek immediate medical attention.

THE CARBONATING BOTTLE DOES NOT RELEASE ITSELF FROM THE SNAP-LOCK:

- Gently pull the carbonating bottle towards you until it reaches its fully forward tilt position. Never pull the carbonating bottle out of the Snap-Lock; always allow the bottle to release itself. If the carbonating bottle does not immediately release from the Snap-Lock wait a few moments and it may release. If it still does not release, then push the bottle back into the vertical position and repeat the process to release it.

YOU HEAR THE SOUND OF LEAKING GAS AFTER INSTALLING A NEW CYLINDER INTO THE SPARKLING WATER MAKER:

- Screw the cylinder tighter into its fitting. **DO NOT** use tools.

YOU EXPERIENCE POOR CARBONATION:

- **⚠ WARNING:** To prevent personal injury: **DO NOT** re-carbonate after adding flavour.
- If you have not yet added flavour, carbonate again to a higher carbonation level.
- Carbonate using cold water.
- If you still experience poor carbonation you may be out of gas. Replace the cylinder.

WATER OVERFLOWS FROM THE CARBONATING BOTTLE DURING CARBONATION:

- Check that the carbonating bottle is filled only to the fill line.
- Verify that the carbonating bottle is firmly installed in the Snap-Lock. Check by gently pulling the bottom of the bottle. If it feels loose, then remove and reinsert.

THE FLAVOUR IN YOUR SPARKLING BEVERAGE IS NOT STRONG ENOUGH:

- Just add more flavour to taste!
- **⚠ WARNING:** To prevent personal injury: **DO NOT** re-carbonate after adding flavour.

SMALL PIECES OF ICE APPEAR IN THE WATER DURING CARBONATION:

- This might happen when carbonating very cold water. If this happens, shorten the time of each press until the ice stops appearing otherwise it can affect the carbonation. Any ice created will simply melt.

Still having trouble?

Contact your local customer service representative by visiting www.sodastream.com and selecting your country.

SODASTREAM LIMITED WARRANTY

Great care has been taken to ensure that your Sparkling Water Maker was delivered to you in good condition. SodaStream warrants, subject to the terms and conditions set forth in this limited warranty, that your Sparkling Water Maker will be free of defects in materials and workmanship under normal home use for 1 **(one)** year following the date of purchase.

It is recommended that you register your Sparkling Water Maker online by visiting www.sodastream.com, selecting your country and completing the product registration form available on the website.

If your Sparkling Water Maker malfunctions within the warranty period, and we determine the problem is due to faulty workmanship or materials, SodaStream will repair or replace it free of charge at SodaStream's discretion within the limitations set out in this warranty. SodaStream may replace your Sparkling Water Maker with a reconditioned Sparkling Water Maker, or an equivalent one if the model you purchased is no longer available. No refunds shall be given. This limited warranty is available to consumers who purchased the Sparkling Water Maker at retail for personal, family or household use.

This warranty DOES NOT cover:

- Abuse, misuse, alteration of the Sparkling Water Maker, or commercial use;
- Damage resulting from carbonating liquids other than water;
- Normal wear and tear (e.g. discoloration);
- Product malfunctions that were a result, in whole or in part, by alteration, disassembly, or repair of the Sparkling Water Maker by a servicer other than an authorised SodaStream Service Center;
- Damage resulting from the use of cylinders or carbonating bottles other than those approved by SodaStream for use with your Sparkling Water Maker;
- Damage resulting from use of the Sparkling Water Maker with an adapter valve;
- Damage resulting from the use of an expired carbonating bottle;
- Damage caused by accident, shipment or anything other than normal household use;
- The carbonating bottles and cylinders.

SodaStream is not liable for incidental or consequential damages. The consumer's sole and exclusive remedy shall be repair or replacement according to the terms and conditions of this warranty. Some local laws do not allow the exclusion or limitation of these damages, so these exclusions may not apply to you. To the extent that this warranty is inconsistent with local law, this warranty shall be deemed modified to be consistent with such local law.

You may also have other rights, which vary in accordance with local laws. The benefits given to the consumer by this warranty are in addition to other rights and remedies that may be afforded to the consumer by law in relation to this Sparkling Water Maker.

TO OBTAIN WARRANTY SERVICE

If your Sparkling Water Maker is in need of warranty service, please contact your local SodaStream Customer Service by visiting www.sodastream.com and selecting your country to find your local contact details. A SodaStream representative will give you specific instructions on how to arrange for the shipment of your Sparkling Water Maker, at your expense, to one of our authorized service centers. Only SodaStream, or its agents, are authorised to provide warranty repairs or service to your Sparkling Water Maker. Repair by a third party voids the warranty.

NON-WARRANTY SERVICE

If SodaStream or its authorised agents determine that the malfunction or damage is not covered by the warranty, SodaStream will repair the Sparkling Water Maker only upon payment of the determined repair charge.

TERMS AND CONDITIONS

Any and all claims, complaints, demands for judgment or legal actions brought hereunder relating in any way to your Sparkling Water Maker shall be governed by, and construed in accordance with, the local laws of the country in which the SodaStream Sparkling Water Maker was purchased.

SODASTREAM CYLINDERS

Your Sparkling Water Maker has been designed to operate with a SodaStream CO₂ cylinder. The use of other CO₂ cylinders is not recommended as they may not be compatible with a SodaStream Sparkling Water Maker. Damages resulting from the use of a cylinder other than a SodaStream cylinder are not covered by the warranty. The SodaStream CO₂ cylinder is provided to you under license. The license allows you to exchange your empty cylinder for a full one for the price of the gas content only, at a participating SodaStream authorised retailer. For a list of local retailers near you and ordering information visit www.sodastream.com and select your country.

SODASTREAM CARBONATING BOTTLES

Your Sparkling Water Maker has been designed to operate with a suitable SodaStream carbonating bottle. Damages resulting from the use of a bottle other than a suitable SodaStream carbonating bottle are not covered by the warranty. Before each use, check the expiration date on the carbonating bottle, and check for damage and deformation. Replace expired, damaged or deformed carbonating bottles with new ones. SodaStream carbonating bottles are available from authorised SodaStream retailers.

PRODUCT DISPOSAL INSTRUCTIONS

Please recycle your expired and damaged carbonating bottles in accordance with local recycling laws. The packaging in which SodaStream products are supplied is made of recyclable materials. Contact your local authority for further information on recycling.

MACHINE RATING OF SODASTREAM SPARKLING WATER MAKERS:

Maximum Working Pressure: 145 psi/10 bar

Maximum Allowed Operating Temperature: 40°C / 104°F

To find the contact details of your local SodaStream Customer Service please visit www.sodastream.com and select your country.

SODASTREAM is a registered trademark of Soda-Club (CO₂) SA or its affiliates.

sodastream®

water made exciting

AUSTRALIA

SodaStream Australia
21 Henderson Road, Knoxfield VIC 3180,
Australia
Tel: 1300763 278
E-Mail: sales@sodastream.com.au
www.sodastream.com.au
www.facebook.com/SodaStreamAustralia
www.instagram.com/sodastreamau
twitter.com/SodaStreamau
www.youtube.com/user/SodaStreamOz

NEW ZEALAND

PO Box 100-707 NSMC Auckland 0745
Tel: 0800 232 633
E-Mail: fizzy@sodastream.co.nz
www.sodastream.co.nz
www.facebook.com/SodaStreamNZ
www.instagram.com/sodastreamnz

SINGAPORE

Komo Pte Ltd
65 Ubi Road 1,
Oxley Bizhub #01-93,
Singapore 408729
SparklingWater@Komoinc.com
Online Sales & Delivery
www.sodastream.sg
www.facebook.com/sodastream.sg
www.instagram.com/sodastreampsingapore
twitter.com/sodastreamsg

SOUTH AFRICA

Bowline Fulfillment (PTY) Ltd
Unit 10, West Building,
North Precinct,
Topaz Boulevard, Montague Park, 7441,
South Africa
tel: +27 21 550 9700
www.sodastream.co.za
www.instagram.com/sodastreamsa
twitter.com/SA_Sodastream
www.youtube.com/channel/UCFTT3TIEC05AyKrAfE28RKg