



**Installation & Owner's Manual**  
ALL IN ONE Type Air-source Heat Pump Water Heater  
EcoSpring ES190

Thank you very much for purchasing our product,  
Before using your unit, please read this manual carefully and keep it for future reference.



## WARNING!

This unit is required reliable earthing before usage, may otherwise result in death or injury.



If you can't make sure that your house power supply is earthed well, please don't install the unit.

The unit must be installed by a licensed tradesperson and in accordance with:

- **EcoSpring installation instructions.**
- **AS/NZS 3500.4- "National Plumbing and Drainage Code Hot Water Supply Systems-Acceptable Solutions".**
- **AS/NZS 3000-Wiring Rules.**
- **Local authority regulations.**
- **NZ Building Code.**
- **Local Occupational Health and Safety (OH&S) Regulations.**

## NOTICE TO CUSTOMERS

This water heater must be installed by a licensed person as required by the Building Code. Only a licensed person will give you a compliance certificate, showing that the work complies with all the relevant standards.

**Please read and understand this booklet. If you have any questions, please contact our service representative on 0800 200 510.**

## HOT WATER CAN BE DANGEROUS

**Warning – Hot water burns. As a safety precaution, young children should always be supervised around hot water fixtures.**

Heat pump water heaters can store water at temperatures that can cause scalding. Water temperatures over 50°C can scald and care needs to be taken to ensure that injuries do not occur through incorrect use of your water heater.

As heat pump water heaters can generate water temperatures in excess of 60°C, regulations require that a tempering valve be fitted to the heater to prevent water temperatures going to the home exceeding a preset safe maximum. The tempering valve must be connected to the hot water outlet line from the water heater. The valve must be fitted by an authorized plumber at the time of installation or in retrofitting to existing systems.

Care should be taken to avoid coming into contact with any pipe work or fixtures associated with the water heater pipe lines. **Under NO circumstances should any 'home handy man' type modifications be attempted.**

- This appliance is not intended for use by persons (including children) with reduced physical sensory or mental capabilities, or lack of experience and knowledge, that prevents them from using the appliance safely without supervision or instruction. Children should be supervised by a responsible person for their safety to ensure that they do not play with the appliance.
- **DANGER:** Failure to operate the relief valve easing gear at least once every six months may result in the water heater exploding. Continuous leakage of water from the valve may indicate a problem with the water heater.
- **THE INSTALLATION MUST COMPLY WITH THE REQUIREMENTS OF AS/NZS 3500.4, AS/NZS 3000, and all local codes and regulatory authority requirements. In New Zealand, the installation must conform to the New Zealand Building Code G12.**

The power supply must be protected by an individual circuit breaker at the main electrical supply switchboard and rated to suit the booster size. The supply to the heat pump water heater can be operated directly from the switchboard or via a remotely mounted switch or time clock as requested by the customer. The heater must be provided with a suitable means for disconnecting the power supply.

# PARTS NAMES

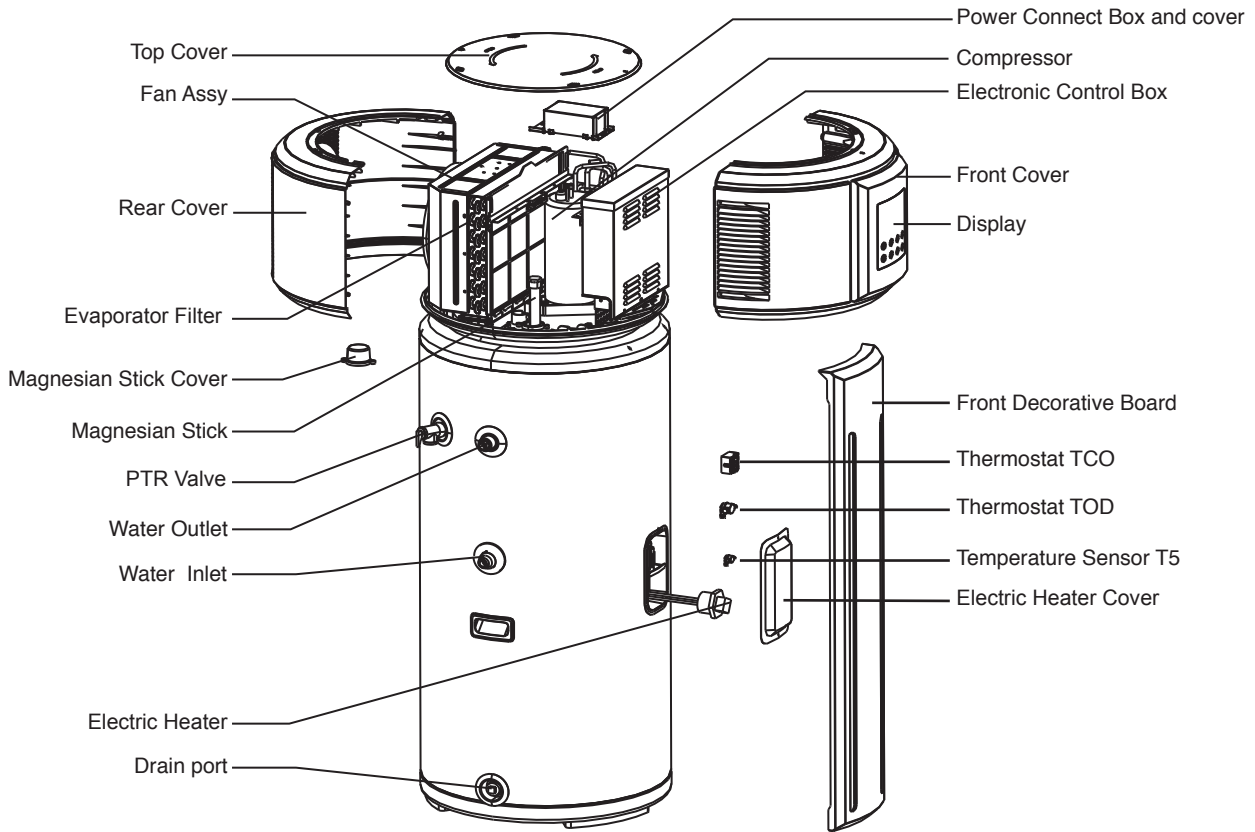

## NOTE

The pictures in this manual are for explanation purpose only. They may be slightly different from the heat pump water heater you purchased (depending on model).

**CONTENTS**

**PAGE**

BASIC OPERATION PRINCIPLE.....	3
SAFETY INFORMATION.....	3
BEFORE INSTALLATION.....	4
INSTALLATION.....	6
OPERATING INSTRUCTIONS.....	8
OPERATION .....	11
TROUBLE SHOOTING.....	14
MAINTENANCE.....	16
SPECIFICATIONS.....	17

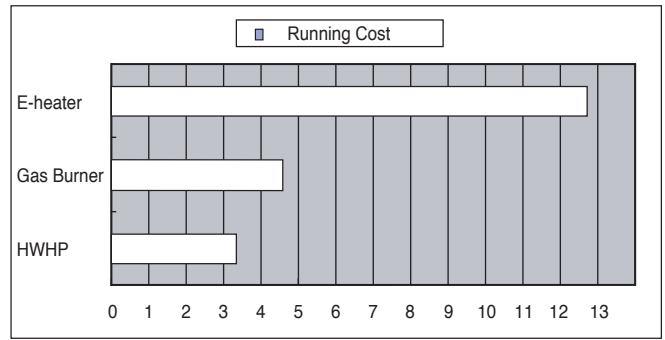

Fig.1-1



**NOTE**

Above calculations are based on ideal conditions, the final amount will be different the actual running will vary with conditions, such as running period, ambient temperature, etc.

**1. BASIC OPERATION PRINCIPLE**

We know from experience, the natural flow of heat, moves from a higher to a lower temperature source, a heat pump can transfer heat from a lower temperature source to a higher temperature source with high efficiency.

The advantage of a heat pump water heater is that it can supply more heat energy, normally 3:1 times than input electricity power by extracting the heat from ambient atmosphere in a free-of charge way and transfer to Sanitary Hot Water. Compared to a traditional water heater, such as electric water heater or gas burner water heater, their efficiency is normally less than 1:1, which means you can dramatically cut off the bill of family daily SHW by the application of heat pump water heater, the following examples will show more details.

Power consumption comparison under the same condition to heat 1 ton of water from 15°C to 55°C.

$$Q=cM(T1-T2)=1(kCal/kg^{\circ}C)X1000(kg)X(55-15)(^{\circ}C)=40000kCal=168MJ=46.67kW^*h$$

Table 1-1

	HPWH	Gas Burner	E-heater
Energy Resource	Air,Electricity	Gas	Electricity
Transfer Factor	860kCal/kW*h	8905kCal/m <sup>3</sup>	860kCal/kW*h
Average Efficiency (W/W)	3.5	0.8	0.95
Energy Consumption	13.33kW*h	210MJ	49.13 kW*h
Unit Cost	0.25 NZD/kW*h	2.2C/MJ	0.25 NZD/kW*h
Running Cost NZD	3.33	4.62	12.28

**2. SAFETY INFORMATION**

Please read thoroughly all of the instructions before installing or operating the unit.

The following safety warnings are very important, always read and obey all safety symbols:



**WARNING**

- The unit must be earthed effectively.
  - This appliance must be installed in accordance to AS/NZS standards and the NZ Building code.
  - A RCD breaker must be installed adjacent to the power supply.
  - Do not remove, cover or deface any permanent instructions, labels, or the data label from either the outside of the unit or inside of unit panels.
  - Only qualified persons should perform the installation of this unit in accordance with local national regulations and this manual.
- Improper installation may result in water leakage, electric shock or fire.
- Ask qualified person for relocating, repairing and maintaining the unit.
- Improper installation may result in water leakage, electric shock or fire.
- Electric connection work should comply with the instructions of local power company, local electric utility and this manual.
  - Never use an incorrectly fuse rated, otherwise the unit may break down and risk of electrical fire.
  - Do not insert fingers, rods or other objects into the air inlet or outlet. The fan is rotating at high speed, and may cause injury.
  - Never use a flammable spray such as hair spray, lacquer paint near the unit. It may cause a fire.
  - This appliance is not intended for use by persons (including children) with reduced physical, sensory or mental capabilities, or lack of experience and knowledge, unless they have been given supervision or instruction concerning use of the appliance

by a person responsible for their safety. Children should be supervised to ensure that they do not play with the appliance.

- If the supply cord is damaged, it must be replaced by the manufacturer or its service agent or a similarly qualified person.
- **DISPOSAL:** Do not dispose this product as unsorted municipal waste. Collection of such waste separately for special treatment is necessary. Do not dispose of electrical appliances as unsorted municipal waste, use separate collection facilities. Contact your local government for information regarding the collection systems available.



## CAUTION

- The earthing pole of socket must be well grounded, make sure that power supply socket and plug are dry and connected tightly.
- Before cleaning, be sure to stop the operation and turn the breaker off or pull out the power plug. Otherwise, an electric shock and injury may be caused.
- Water temperature over 50°C can cause severe burns instantly or death from scalds. Children, disabled and elderly are at highest risk of being scalded. Feel water before bathing or showering. Water temperature limiting valves are required as per NZ Building Code.
- Do not operate the unit with a wet hand. An electric shock may be caused.
- The installation height of power supply should be over 1.8m, if there is any water exposure, steps must be taken to separate the power supply from water.
- A one-way valve must be installed on the water inlet side, as well as an isolation valve.
- All valves installed must comply with AS/NZS standards.
- It is normal for some water to be released from the PTR valve during operation. But, if there is a large volume of water, call your service agent for instructions. After long term use, check the unit base and fittings. If damaged, the unit may sink, resulting in injury. Arrange the drain pipe to ensure smooth draining. Improper drainage work may cause wetting of the building, furniture etc. Do not touch the inner parts of the controller or remove the front panel. Some parts inside are dangerous to touch, and damage may be caused.
- Do not turn off the power supply.

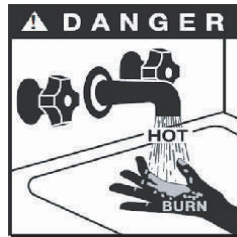

System will stop or restart heating automatically. A continuous power supply for water heating is necessary, except service and maintenance.

## 3. BEFORE INSTALLATION

### 3.1 Unpacking

#### 3.1.1 Accessories

Table 3-1

Accessory Name	Qty.	Sharp	Purpose
Owner's and Installation Manual	1		Installation and user instructions
Drain pipe for water condensation	1		Used to drain water condensation (has been connected to the lower condensate drain port)
Film Label	1		Protects display during transit. Please remove after installation.

#### 3.1.2 How to transport

- 1) In order to avoid scratching or deforming the unit surface, apply guard boards to the contacting surfaces. No contact of fingers and other things with the vanes. Don't incline the unit more than 45° in moving, and keep it vertical when installing.

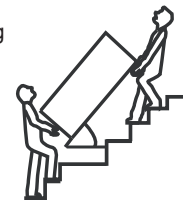

- 2) This unit is heavy, it needs to be carried by two or more persons, otherwise might cause injury and damage.

### 3.2 Location requirements

- 1) Enough space for installation and maintenance should be preserved.
- 2) The air inlet and outlet should be free from obstacles and strong wind.
- 3) The base surface should be flat, surface should be inclined no more than 2° and able to bear the weight of the unit and suitable for installing the unit without increasing noise or vibration.
- 4) The operating noise and air flow expelled should not affect neighbors.
- 5) No flammable gas nearby.
- 6) It should be convenient for piping and wiring.
- 7) If it is installed in indoor space, it might cause indoor temperature to decrease and noise disturbance, Please take preventive measures for this.
- 8) If the unit has to be installed on a metal part of building, make sure the electric insulation meets the relevant local electric



## CAUTION

- The ambient air temperature must also be considered when installing this unit, in heat pump mode the ambient air temperature must be above 5°C and below 43°C. If the ambient air temperature falls outside these upper and lower limits, the electrical elements will activate to meet the hot water demand and the heat pump will not operate.
- The unit should be located in an area not subject to freezing temperatures. A unit located in unconditioned spaces (i.e., garages, basements, etc.) may require the water piping, condensate piping, and drain piping to be insulated to shelter against freezing.



## CAUTION

Installing the unit in any of the following places may lead to malfunction (If it is inevitable, consult the supplier prior to purchase).

- The site contains mineral oils such as lubricant of cutting machines.
- Seaside or where the air contains salt.
- Hot spring area where corrosive gases exist, e.g., sulfide gas.
- Factories where the power voltage fluctuates seriously.
- Inside a car or cabin.
- Places with direct sunlight and other heat supplies. If there's no way to avoid these, please install a cover.
- Places like kitchen where oil may permeate system.
- Place where strong electromagnetic fields exist.
- Place where flammable gases or materials exist.
- Place where acidic or alkaline gases exist.
- Other special environments.



## WARNING

- The unit must be securely fixed, otherwise, noise and vibration may result.
- Make sure that there are no obstacle around the unit.
- In places where there are strong winds like seaside, fix the unit in a location protected from the wind.

### 3.3 Maintenance space requirements (unit: mm)

The circulating air for every unit should be more than 350m<sup>3</sup>/h. Make sure there is enough installation space. Refer outline dimensional drawing (see Fig.3-1, Fig.3-2)

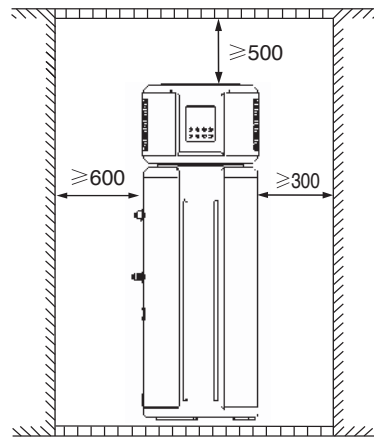
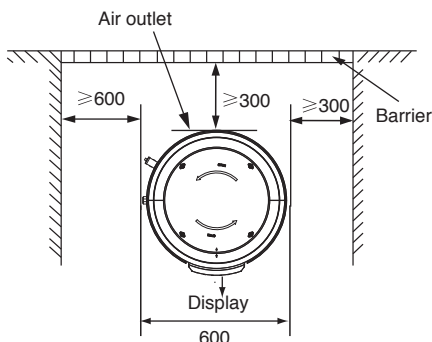

Fig.3-1

### 3.4 If installed in inclosed space

The water heater must be located in a space >15m<sup>3</sup>, and must have unrestricted air flow. As an example, a room that has an 2.5 tall ceiling and is 3 meter long by 2 meter wide would contain 15m<sup>3</sup>.

### 3.5 Unit outline dimension (unit: mm)

Table 3-2

Model	RSJ-15/190RDN3-B
Dimension	
H	1580
ΦA	568
ΦB	560

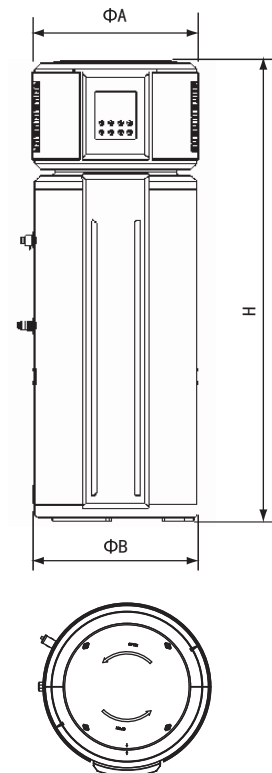

Fig.3-2

## 4. INSTALLATION

### 4.1 Pipeline Connection Schematic

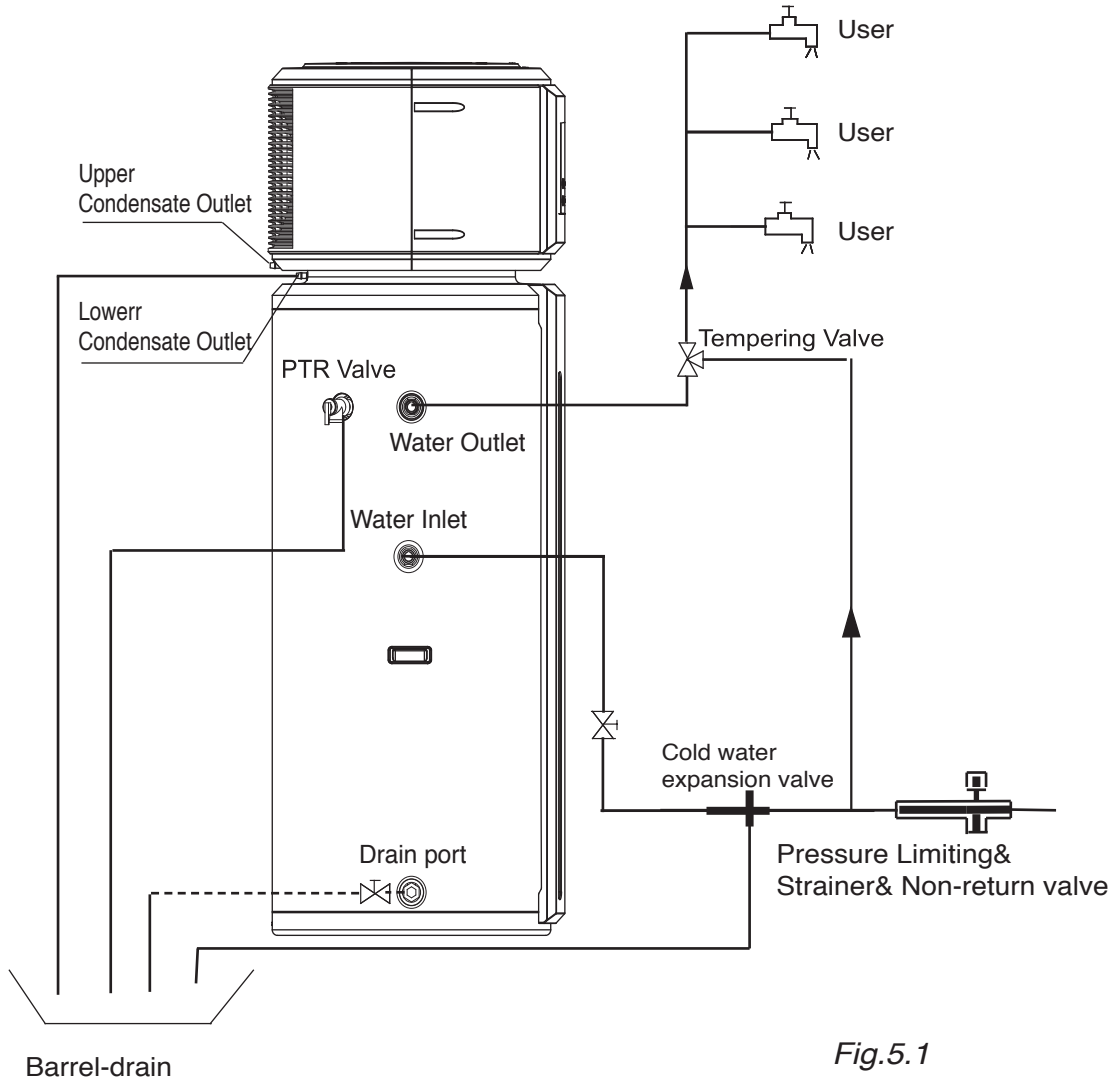

Fig.5.1

- 1) Installation of the water inlet or outlet pipes: The water inlet & outlet thread is G3/4" (external thread). Pipes must be heat-resistant and durable.
- 2) Install the water inlet/outlet pipes and PTR valve in accordance with AS/NZS standards and the NZ Building Code.



### CAUTION

- Piping water system as the above figure. In case of installing where outside temperatures fall below 5 °C, insulation must be provided for all hydraulic components.
- The PTR Valve should be operated every 6 month to make sure that there is no restriction of the valve. Please beware of the hot water from the valve. The drainage pipe should be well insulated in order to prevent water inside pipe from freezing in cold weather.

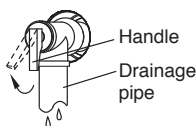

### WARNING

- Do not dismantle the PTR Valve,
- Do not block off the Drainage pipe, it will cause explosion and injury.



- 3) After connection of the water system piping work, turn on the cold water inlet valve and hot water outlet valve and bleed all air from the tank. When water flows smoothly out from water outlet pipe (tap water outlet), the tank is full, turn off all valves and check pipeline to make sure there is no any leakage.
- 4) If the inlet water pressure is less than 0.15MPa, a pump should be installed at the water inlet.
- 5) Condensate may leak from unit if drainage pipe is blocked, a drainage pan is recommended as shown as following figure:



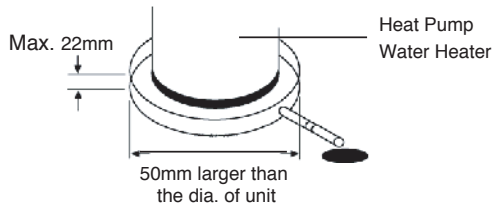

Fig.4-2

## 4.2 Installation requirement

To smoothly drain condensate from unit, please install the main unit is on a horizontal floor. Otherwise, please ensuring the drain vent is at the lowest place. Recommended inclination angle of unit to the ground should be no more than 2°.

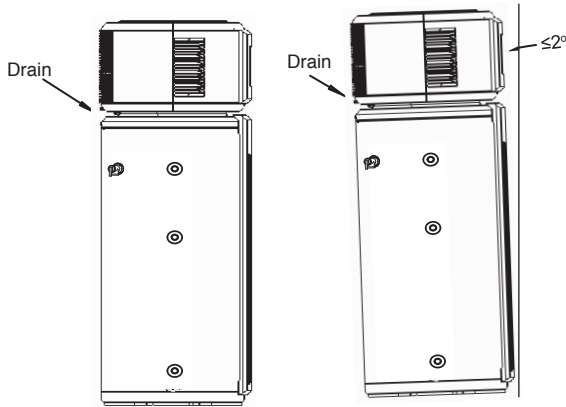

Fig.4-3

## 4.3 Electric Connection

### 4.3.1 Electric Wiring Illustration



#### CAUTION

- Set the electric leakage protector according to the relevant electric technical standards of the State.
- The power cord and signal cord shall be laid out neatly and properly without mutual interference or contacting the connection pipe or valve.
- After wire connection, check it again and make sure of connection before power is turned on.



#### WARNING

The unit must be installed with an RCD near the power supply and must be effectively earthed.

## 4.4 Installation checklist

### 4.4.1 Location

- 1) The flooring beneath the water heater must be able to support  the weight of the water heater when filled with water (286kg full).
- 2) Located indoors (such as a basement or garage) and in a  vertical position. Sheltered from freezing temperatures.

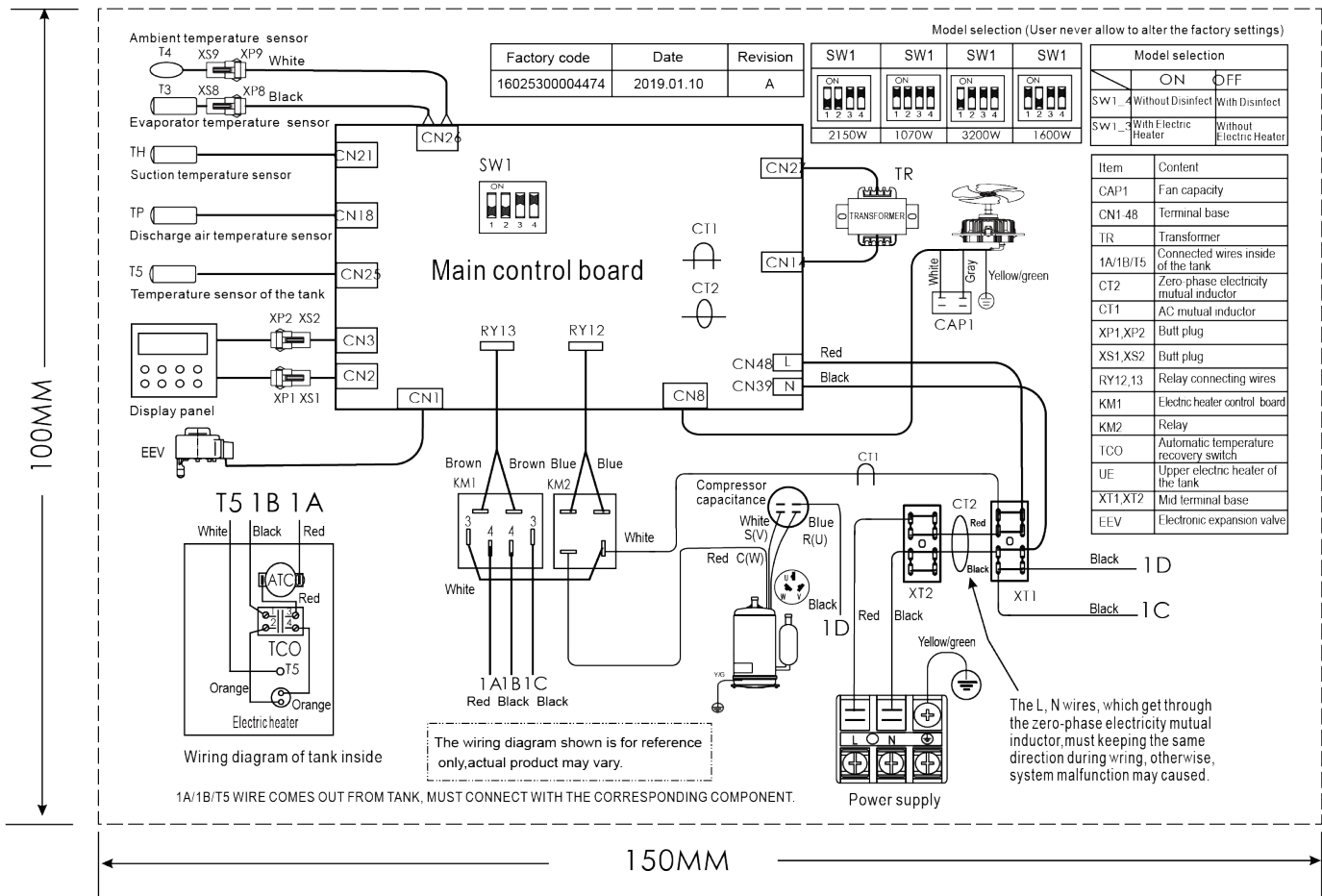



- 3) Provisions made to shelter the area from water damage. Metal drain pan installed and piped to an adequate drain.
- 4) Sufficient room to service the water heater.
- 5) Sufficient air for the heat pump to function, the water heater must be located in a space >15m<sup>3</sup>, and must have unrestricted air flow.
- 6) The unit cannot be placed into any type of closet or small enclosure.
- 7) The site location must be free from any corrosive elements in the atmosphere such as sulfur, fluorine, and chlorine. These elements are found in aerosol sprays, detergents, bleaches, cleaning solvents, air fresheners, paint, and varnish removers, refrigerants, and many other commercial and household products as well as naturally occurring environments. In addition excessive dust and lint may affect the operation of the unit and require more frequent cleaning.
- 8) The ambient air temperature must be above 5°C and below 43°C. If the ambient air temperature falls outside these upper and lower limits the electrical element will be activated to meet the hot water demand.

#### 4.4.2 Water System Piping

- 1) PTR valve (Temperature and pressure relief valve) properly installed with a discharge pipe run to an adequate drain and sheltered from freezing.
  - 2) All piping properly installed and free of leaks.
  - 3) Unit completely filled with water.
  - 4) Tempering valve installed per manufacturer's instructions. Condensate Drain Line Installed.
- Must be located with access to an adequate drain or condensate pump.
- Condensate drain lines installed and piped to an adequate drain or condensate pump.

#### 4.4.3 Electrical Connections

- 1) The water heater requires 220~240 VAC for proper operation.
- 2) Wiring size and connections comply with all local applicable codes and the requirements of this manual.
- 3) Water heater and electrical supply are properly grounded.
- 4) Correctly sized overload fuse or circuit breaker protection installed.

#### 4.4.4 Post Installation Review

- 1) Understand how to use the User Interface Module to set the various modes and functions.
- 2) Understand the importance of routine inspection/maintenance of the condensate drain pan and lines. This is to help prevent any possible drain line blockage resulting in the condensate drain pan overflowing.
- 3) IMPORTANT: Water coming from the plastic shroud is an indicator that both condensation drain lines may be blocked. Immediate action is required.
- 4) To maintain optimal operation check, remove and clean the air

## 5. OPERATING INSTRUCTIONS

### 5.1 Operation steps

Before using this unit, please follow the steps below.

Filling with water: If the unit is used for the first time or used again after emptying the tank, please make sure that the tank is full of water before turning on the power.

Method: see Fig.5-1.

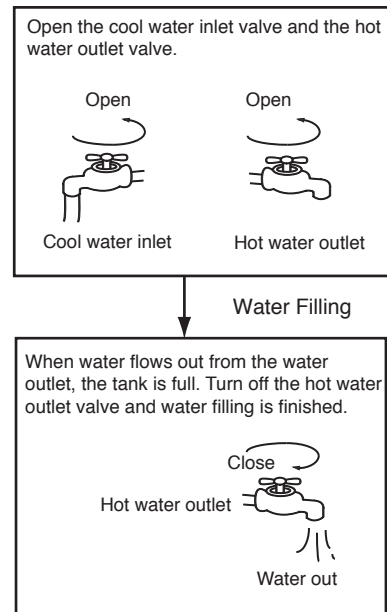
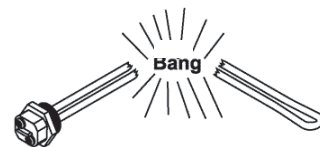

Fig.5-1



### CAUTION

- Operation without water in water tank may result in the damage of auxiliary e-heater. In case of such damage, the manufacturer will not be liable for any damages caused by this issue.



- After powered on, the display lights up. Users can operate the unit through the buttons under the display.
- Emptying: If the unit needs cleaning, moving etc, the tank should be emptied. Method: See Fig.5-2:

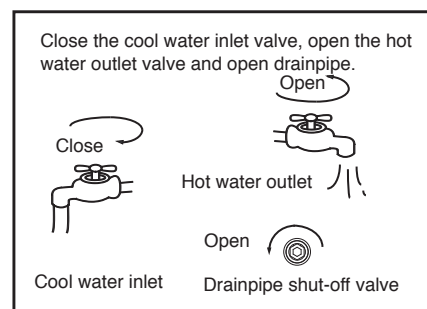

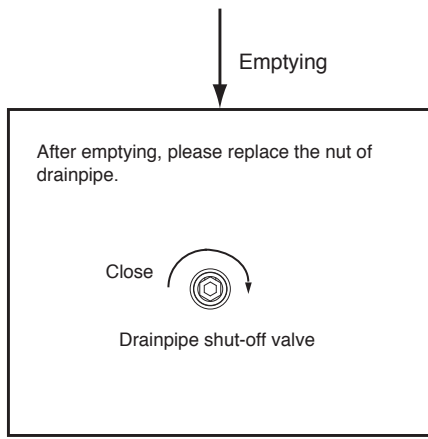

Fig.5-2

## 5.2 Trial- running

### 5.2.1 Check list before commissioning.

- 1) Check list before trial-running.
- 2) Correct installation of the system.
- 3) Correct connection of water/air piping and wiring.
- 4) Condensate draining smoothly well insulated for all hydraulic part.
- 5) Correct power supply.
- 6) No air in the water pipeline and all valves opened.
- 7) Effective RCD installed.
- 8) Sufficient inlet water pressure (between 0.15MPa and 0.70MPa) (150-700kPa).

### 5.2.2 Operating Capability

- 1) This unit has two kinds of heat sources: Heat pump (compressor) and electric heater. The unit has one temperature sensor, which is installed at the upper portion of the tank.

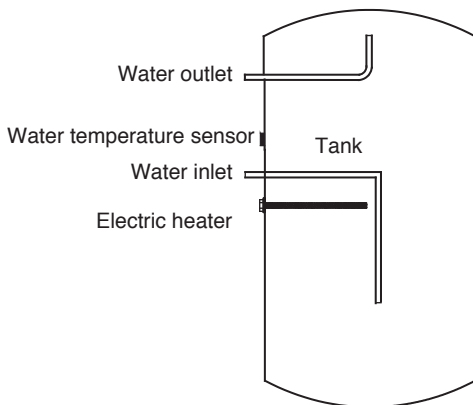

Fig.5-3

### 2) Heat Pump Modes

The unit can operate with three modes: Economy Mode, Hybrid Mode and e-heater Mode. Economy mode is the normal mode.

- 2.1) **Economy Mode:** In this mode, only the heat pump system is in operation. The suitable operating ambient air temperature range is 5~43°C. (Water outlet temperature range 38~65°C, running ambient 5~43°C). 2.2) 2.3)

- 2.2) **Hybrid Mode:** In this mode, the system will adjust the working capabilities of e-heater and heat pump according to the tank water temperature. The system can heat water by the heat pump, e-heater, or together in this mode. The suitable operating air ambient range is -20~43°C. (Water outlet temperature range 38~70°C, running ambient -20~43°C). In this mode, if ambient air temperature is lower than 5°C, e-heater is the only heat source. If the ambient temperature is between 5°C and 10°C, e-heater and the heat pump will activate together. If the ambient temperature is higher than 10°C, it will only activate the heat pump when water temperature is lower than 65°C. When water temperature is above 65°C, only the e-heater will activate.

- 2.3) **e-heater:** In this mode, only the element will be used to heat the water. (Water outlet temperature range 38~70°C, running ambient -20~43°C).

### 3) Water Temperature Display

The temperature shown on the display depends on the water temperature sensor. It is normal that sometimes the display temperature decreases while the unit is running, it is caused when the natural convection of the upper hot water mixes with the bottom cold water which flows from inlet tap.

- 4) Operating mode should be selected manually. Refer to table 5-1. Running Temperature Range Water temperature limits:

Table 5-1

Operation mode	Ambient temp. range	Setting temp. range	Maximum temp. (Heat pump)
Economy mode	5~43	38~65	65
Hybrid mode	-20~43	38~70	65
E-heater mode	-20~43	38~70	--

### 5) Heat Source Shift

- ① The default heating source is heat pump. If ambient temperature range is out of heat pump operating range, heat pump will stop running, the unit will shift automatically to activate e-heater and show the icon LA on the display, then if the ambient temperature goes into the running range of heat pump again, it will stop e-heater and shift automatically to heat pump again, and the icon LA will be extinguished.
- ② If the target water temperature is higher than maximum temperature (Heat pump), the unit will activate heat pump firstly to the maximum temperature, then stop heat pump, activate e-heater to continually heat water to the target temperature.



### NOTE

If the system continuously reports heat pump protection, the latest error code and will be shown on the display, then heat pump will stop running, and the unit will shift automatically to e-heater mode as the backup mode, but the code and will be shown until power is reset.



### NOTE

If only using e-heater mode, approx 60% of the tank water will be heated, so set a higher target water temperature if the ambient temperature is out of the heat pump running range.

- ③ **Defrosting During Water-heating**  
In heat pump running period, if the evaporator becomes frosted in lower ambient temperature, the system will defrost automatically to keep effective performance (about 5~15min). At defrosting time, the compressor will stop, but fan motor will still run.
- ④ **Heat-up Time**  
There are different heat-up times at different ambient temperatures. Normally lower ambient temperature result in longer heat-up times because of lower effective performance.

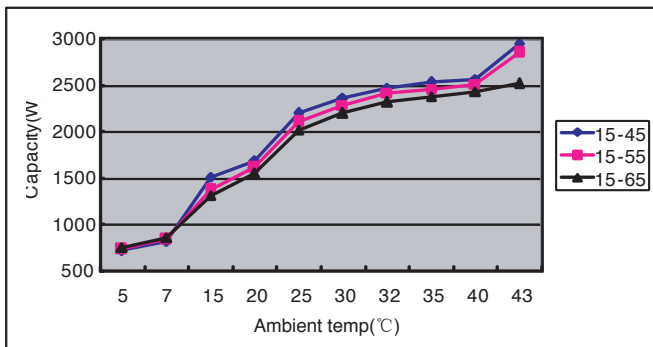

Fig.5-4

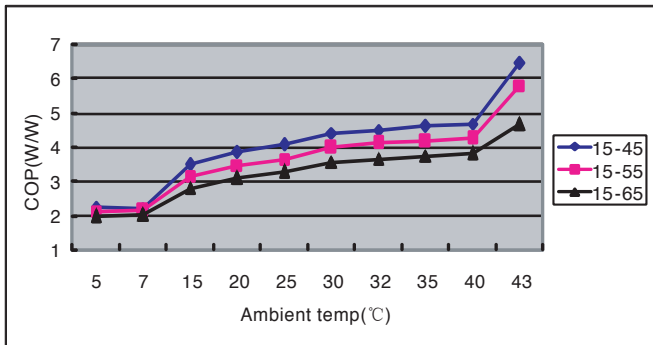

Fig.5-5

### Recovery Time

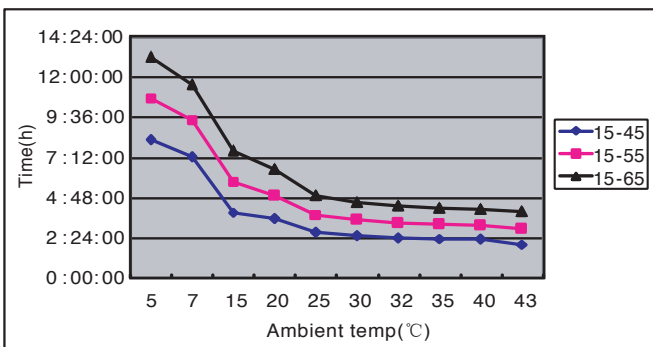

Fig.5-6

#### ⑤ About TCO and TOD

The power of compressor and E-heater will be automatically shut-off or turn on by TCO and TOD.

- If the water temperature is higher than 78°C, the TOD will automatically shut off the power of compressor and E-heater, and turn it on if the temperature fall down below 68°C.
- If the water temperature is higher than 85°C, the TCO will automatically shut off the power of compressor and E-heater, it must be reset by an authorised service technician.

#### ⑥ Restart After a Long Term Stop

When the unit is restarted after a long term stop (trail running included), it is normal that outlet water is unclean. Turn the tap on and the water will be flushed clean.



### NOTE

While the ambient temperature is below 5°C, heat pump efficiency will decrease dramatically, the unit will automatically shift to E-heater mode.

### Defrosting during Water-heating

If the evaporator freezes over in Economy Mode and Hybrid Mode during cold weather, the system will defrost automatically to keep effective performance(3~10 min).

In defrosting mode, the fan motor will run at a high speed and E-Heater will operate.

#### ■ Ambient Temperature

The system's operational temperature is between -20°C~43°C  
The following are the operation temperatures for each mode.

- Economy Mode: 5°C~43°C
- Hybrid Mode: -20°C~43°C
- E-Heater Mode: -20°C~43°C

#### ■ Mode Selection

The different modes are designed to meet different demands and the following are recommended selections.

- Economy Mode: 5~43°C, a continuous hot water demand below 150L(65°C);
- Hybrid Mode: -20°C~43°C, a continuous hot water demand between 150L~200L(70°C);
- E-Heater Mode: -20°C~43°C, a continuous hot water demand between 150L~200L(70°C).

#### ■ Self-Protection Apparatuses

- When the self-protection occurs, the system will be stopped and will begin self-check, and restart when the protection resolved;
- When the self-protection happens, the buzzer will buzz in every other minute, the ALARM indicator will flash and the display will indicate the error code and water temperature alternatively. Press CANCEL key for 3sec to stop the alarm. All stop when the protection is resolved and error code disappears from the display.

#### ■ In the following circumstances, self-protection starts:

- Air inlet or outlet is blocked;
- The evaporator is covered with too much dust;
- Incorrect power supply (exceeding the range of 220-240V)



### NOTE

When self-protection happens, cut the power supply manually and restart after the error resolved.

### 5.2.3 Basic function

#### 1) Weekly disinfect function

Under disinfection mode, unit immediately starts to heat water up to 65°C to kill any potential of legionella bacteria inside water of tank, icon will light on the display screen during disinfection; Unit will quit disinfection mode when water temperature is higher than 65°C and extinguish icon.

#### 2) How to turn on the unit:

If unit is OFF->press ->button will be unlocked ->press



to select mode ->press to set target water temperature->press ->unit will automatically select mode and start to heat water to target temperature.

## 6. OPERATION

### 6.1 Control Panel Explanation

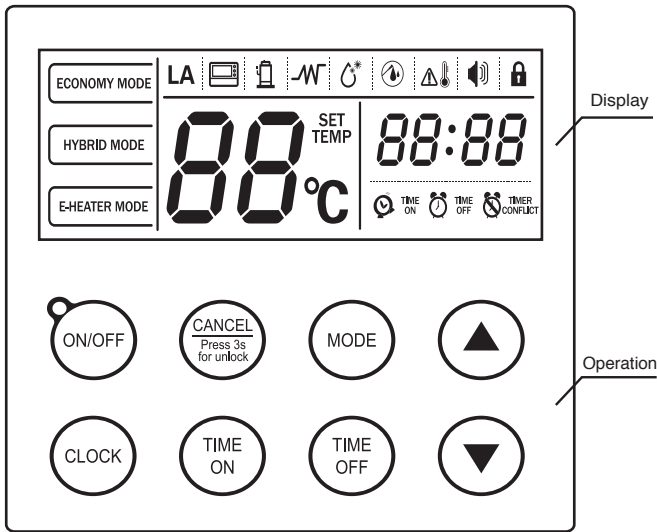

Fig. 6-1

### 6.2 Display Explanation

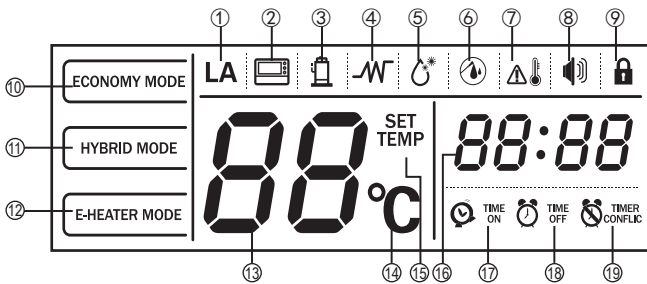







Fig. 6-2

Table 6-1

No	Icon	Description
①	LA	<b>AMBIENT TEMP OUTSIDE THE OPERATIONAL RANGE OF HP:</b> LA will be displayed if the ambient temp. is not in the operating range of the heat pump, otherwise LA will be extinguished.
②		<b>WIRE CONTROLLER (Reserved function):</b> will be displayed if connected to a wire controller, otherwise  will be extinguished.
③		<b>COMPRESSOR:</b> will be displayed if compressor is activated, otherwise  will be extinguished.
④		<b>E-HEATER:</b> will be displayed if e-heater is activated, otherwise  will be extinguished.

No	Icon	Description
⑤		<b>DISINFECTION:</b> will be displayed when the unit is in disinfection mode, otherwise  will be extinguished.
⑥		<b>FILL WATER:</b> will be displayed and flash with 1Hz frequency when the unit is re-powered on if the unit was off at last time of power on, then if press  once,  will be displayed without flashing, then press  again,  will be extinguished all the time.  will not be displayed when the unit is re-powered on if the unit was on at last time of power on.
⑦		<b>HIGH TEMP:</b> If target water temp. is higher than 50°C,  will be lightened, otherwise  will be extinguished.
⑧		<b>ALARM:</b> When unit is displaying protection/error,  will flash with 5Hz frequency as well as buzzer sounding 3 times every minute until protection/error eliminated or press  for 1 second.
⑨		<b>LOCK:</b> will be displayed if buttons are locked, otherwise  will be extinguished.
⑩		<b>ECONOMY MODE:</b> will be displayed if unit is operating in Economy Mode. When selecting mode,  will flash with 1Hz frequency if Economy Mode is selected at the off time.
⑪		<b>HYBRID MODE:</b> will be displayed if unit is operating in Hybrid Mode. When selecting mode,  will flash with 1Hz frequency if Hybrid Mode is selected at the off time.
⑫		<b>E-HEATER MODE:</b> will be displayed if unit is operating in E-heater Mode. When selecting mode,  will flash with 1Hz frequency if E-heater Mode is selected at the off time.
⑬	88°C	<b>WATER TEMP:</b> 88 will be displayed all the time. 88 shows water temperature on normal time; 88 shows setting temperature when setting temperature; 88 shows unit setting/running parameters, error/protection code under query mode.
⑭	°C	<b>TEMP-UNIT:</b> °C will be displayed if 88 displays temperature, otherwise °C will be extinguished.

15	SET TEMP	<b>SET-TEMP:</b> SET TEMP will be displayed when setting water temp., otherwise SET TEMP will be extinguished.
16	88:88	<b>CLOCK:</b> 88:88 will be displayed all the time. 88:88 shows current clock on normal time; 88:88 shows setting clock when setting timer.
17		<b>TIME ON:</b>  will be displayed if the timer is set.
18		<b>TIME OFF:</b>  will be displayed if the timer is set.
19		<b>TIME CONFLICT (Reserved function):</b>  will be displayed if the timer which has been set on the control panel is not the same as that set on the ware controller.

### 6.2.1 Operation interface

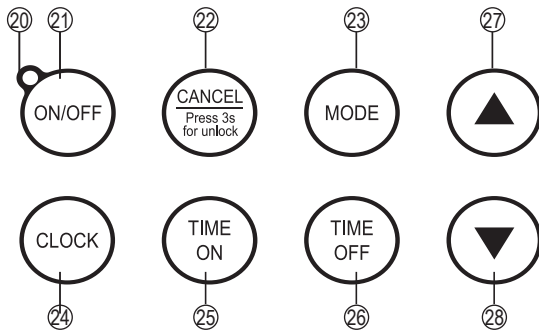

















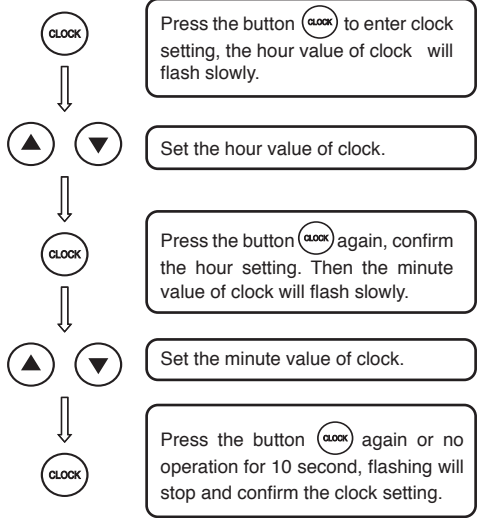

Fig. 6-3

Table 6-2

20		<b>OPERATION INDICATOR:</b>  will be displayed if unit is ON, otherwise  will be extinguished.
21		<b>ON/OFF</b> Press button  can turn on or turn off the unit. <b>Preparation before running the unit.</b> When the unit is powered on for the first time, all the indicators on the display will be displayed for 3 seconds and the buzzer will "didi" ring twice at the same time, then, display the nominal page. After no operation for 1 minute, all indicators will be extinguished automatically except  indicator (flash slowly) and water temperature. Buzzer will "di" ring when you press any button. <b>CAUTION</b> Confirm the tank is full of water or not when  indicator is flashing. If tank is full of water, press the button  , the  indicator will stop flashing and you can continue to adjust other settings. When all settings finished, press the button  again and the  indicator will be extinguished. And then the unit will operate automatically. Auto-operation

22		<b>Cancel</b> <b>Unlock Control Panel:</b> In order to prevent wrong operation, a special lock function has been designed. If there is no operation for 1 minute, control panel will be locked automatically, and display the lock indicator  . If the control panel is locked, no button can be operated. Press button  for 3 seconds to unlock, then all buttons could be operated normally.
23		<b>Mode Selection</b> Press button  to select operation mode. The unit can operate with three modes: Economy Mode, Hybrid Mode and E-heater Mode. Economy mode is the normal mode. <b>ECONOMY MODE:</b> The unit can heat water only by heat pump system in this mode. The suitable operation ambient temperature range is 5~43°C. <b>HYBRID MODE:</b> The unit can heat water by heat pump system, e-heater, or together in this mode. The suitable operation ambient temperature range is -20~43°C. In this mode, if ambient temperature is lower than 5°C, e-heater is the only heat source. If the ambient temperature is between 5°C and 10°C, e-heater and the heat pump will active together. If the ambient temperature is higher than 10°C, it will only activate the heat pump when water temperature is lower than 65°C and only active e-heater when water temperature is higher than 65°C. <b>E-HEATER MODE:</b> The unit can heat water only by e-heater in this mode. The suitable operation ambient temperature range is -20~43°C.
24		<b>Set Clock</b> The clock is for a 24-hour system and the initial time is 00:00. To make a better use of this unit, it is recommended to set the time for accurate local time. Every time powered off, the clock will be reset to the initial time 00:00. 



**Set Timer-TIME ON ONLY**  
**Time on only:**

If the Timer is set to TIME ON, the unit will automatically operate once between the setting of the clock and the last 24 hours.

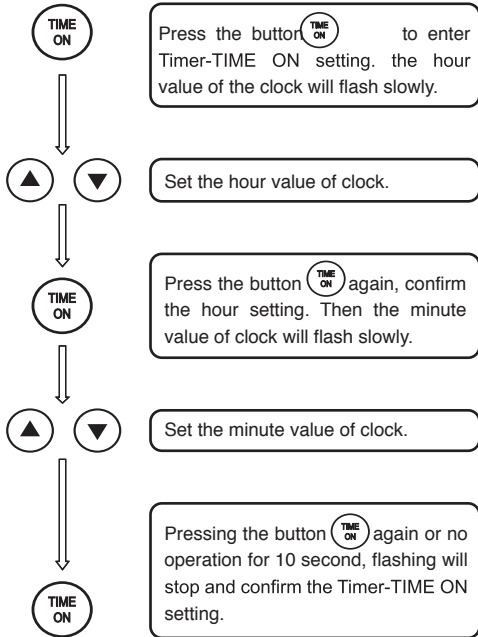

**Cancel Timer-TIME ON ONLY**

In the unlocked state, press the button  for 3 second and the Timer-TIME ON function will be canceled.

**Set Timer-TIME ON & TIME OFF**  
**Time on & Time off:**

If set the Timer-TIME ON & TIME OFF, the unit will automatically operate between the setting TIME ON clock and TIME OFF clock.

If the TIME OFF clock is the same as TIME ON clock, TIME OFF clock will be delayed 10 minutes automatically.

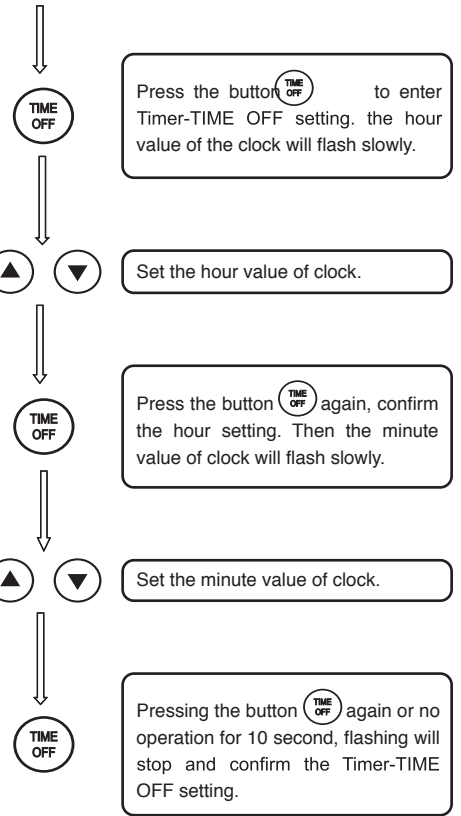
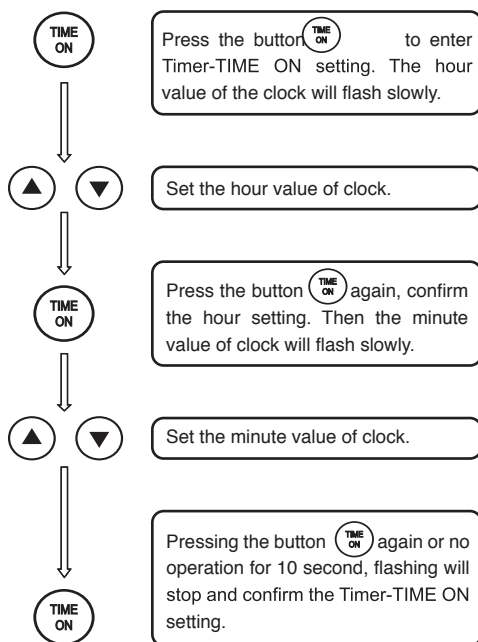



**Cancel Timer-TIME ON&TIME OFF**

In the unlocked state, press the button  for more than 3 seconds and the Timer-TIME ON & TIME OFF function will be canceled.



**INCREASE/UP**

If button is unlocked, corresponding value will increase by pushing .







- When setting temperature, press  for more than 1s, temperature value will be increased continuously;
- When Setting clock/timer, press  for more than 1s, Clock/timer value will be increased continuously.

**DECREASE/DOWN**

If button is unlocked, corresponding value will decrease by pushing .

- When setting temperature, press  for more than 1s, temperature value will be decreased continuously;
- When Setting clock/timer, press  for more than 1s, Clock/timer value will be decreased continuously.

## 6.3 Combination button

No.	Icon	Description
Clear error code	 + 	Press the two buttons at the same time to clear all stored error & protect codes, and the buzzer will buzz one time.
Query mode	 + 	Press the two buttons at the same time for 1sec to go into query mode. Under query mode user can check unit setting & running parameters by pressing   circularly. Press button  for 1s or no button operation for 30s, then quit query mode.

## 6.4 Auto-restart

If power is disconnected, the unit can remember some of the setting parameters (On or Off state, operating mode, setting water temperature); when it re-powers on, the unit will be operated as per the previous settings.

## 6.5 Button Auto Lock

When there is no operation of button for 1 minute, buttons will be locked except Unlock button  Press  for 3s, unlock buttons.

## 6.6 Screen Auto Lock

If there is no operation of button for 30s, screen back light will be extinguished. Press any button will lighten the screen back light.

# 7. TROUBLE SHOOTING

## 7.1 Non-error tips



Q: Why can't the compressor start immediately after setting?

A: Unit will wait for 3 min to balance the pressure of system before starting compressor again, it is a self protection logic for the unit.

Q: Why is the temperature shown on the display panel sometimes decrease while unit is running?



A: When the upper tank temperature is much higher than the bottom part, upper part hot water will be mixed with the bottom cold water which flows from inlet tap water, so that will decrease the average temperature.

## 7.2 Self-protection of unit

- When the self-protection mode activates, the system will be stopped and start a self-check, and restart when the error is resolved.
- When the self-protection mode activates, the buzzer will buzz every second minute, the  will flash and error code will be shown at water temperature indicator. Press  button for 1sec to stop buzz, but the  and error code will not disappear until the error is resolved.

- In the following circumstance, self-protection may happen:
  - If air inlet or outlet is blocked;
  - If the evaporator is covered with too much dust;
  - Incorrect power supply (exceeding the range of 220-240V).

## 7.3 When an error occurs

- If some cases of error happen, the unit will automatically shift to E-heater for emergency SHW supply, please contact authorised technician to repair.
- In case of serious errors, the unit will not start, please contact authorised service agent.
- For some errors, the buzzer will buzz 3 times every other minute and the  will flash fast. Press  for 1 sec to stop the buzzer but the alarm icon will keep flashing.

## 7.4 Trouble shooting

Table. 7-1

Error	Possible reason	Solution
Cold water out and display screen extinguished	<ol style="list-style-type: none"> <li>Bad connection between power supply plug and socket;</li> <li>Setting water temperature too low;</li> <li>Temper sensor broken ; PCB of indicator broken; Compressor broken.</li> </ol>	<ol style="list-style-type: none"> <li>Plug in;</li> <li>Setting water temp. higher;</li> <li>Contact service center.</li> </ol>
No hot water out	<ol style="list-style-type: none"> <li>Water supply interrupted; Cold water inlet pressure too low (&lt;0.15 Mpa);</li> <li>Cold water inlet valve closed.</li> </ol>	<ol style="list-style-type: none"> <li>Check water supply; Waiting for inlet water</li> <li>pressure increase; Open water inlet valve.</li> <li></li> </ol>
Water leakage	Hydraulic pipeline joints are not sealed well.	Check and reseal all joints.

### 7.4.1 Non-error Malfunction

- 3-minute Protection**  
With the power supplied, an immediate restart after the shutting down will require a 3 minute wait to protect the compressor.
- If self-protection occurs and the system stops, check :
  - When the power indicator lights up, whether the system has been forced to run while startup requirement has not been met as above;
  - If the air outlet or inlet is jammed or strong wind blows to air outlet.
  - Defrosting  
When the environment is humid and cold, the evaporated water may freeze and the water-heating capacity thus decreases. When this happens, the system will stop heating water to defrost, then restart water-heating upon completion.
  - During defrosting, fan stops working, four-way valve reverses the flow direction, and compressor keeps working.
  - The defrosting time varies from 3 minutes to 10 minutes depending on the ambient temperature and the frost.
- Temperature Display**
  - When the system stops, a decrease of water temperature is normal as heat loss will occur. When it decreases to a certain point, the system will restart automatically;
  - During water-heating, the displayed water temperature might still decrease or not increase for a period of time because of the heat exchange of the water. When the whole tank of water has reached the set temperature, the system will stop automatically.



## 7.5 Error code shooting table

Table. 7-2

Display	Malfunction Description	Corrective action
E1	Error of sensor T5L(lower water temperature sensor)	Maybe the connection between sensor and PCB is broken or sensor has been broken. Contact a qualified person to service the unit.
E2	Tank and wired controller communication error	The connection between controller and PCB is broken or PCB has been broken.
E4	Evaporator temperature sensor T3 error	The connection between sensor and PCB is broken or sensor has been broken. Contact a qualified person to service the unit.
E5	Ambient temperature sensor T4 error	The connection between sensor and PCB is broken or sensor has been broken. Contact a qualified person to service the unit.
E6	Compressor discharge temperature sensor TP error	The connection between sensor and PCB is broken or sensor has been broken. Contact a qualified person to service the unit.
E8	Electric leakage error If PCB current_induction_circuit check the current difference between L,N >14mA, system consider it as "electric leakage error"	Some wires have been broken or bad wiring connection. Contact a qualified person to service the unit.
E9	Compressor suction temperature sensor TH error	The connection between sensor and PCB is broken or sensor has been broken. Contact a qualified person to service the unit.
P8	E-heater open-circuit protection (IEH(Current difference E-heater on & e-heater off )<1A)	Maybe the E-heater has been broken or bad wiring connection after repair.
P2	High discharge temperature protection Tp>115℃, Protection active Tp<90℃, Protection inactive	System blocked, air or water or low refrigerant(leakage) in system (after repair), water temperature sensor malfunction, etc. Contact a qualified person to service the unit.
P4	Compressor overloaded protection (10 secs after compressor start up), Current checking starts , 1)only compressor running, if it is >7A , the compressor will be stopped and protected. 2)Compressor+e-heater opend, if it is >IEH+7,the compressor will be stopped and protected.	Compressor broken, system blocked, air or water or too much refrigerant in system (after repair), water temperature sensor malfunction, etc.
LA	When the ambient temp T4 is out of Heat Pump running range (5~43℃) Heat Pump will stop, unit will show LA on the position of clock on display until T4 back to (5~43℃).	It is normal, and not necessary to repair.



### NOTE

The diagnostic codes listed above are the most common. If a diagnostic code not listed above is displayed, contact residential technical assistance referencing the number on the front of this manual.

## 8. MAINTENANCE

### 8.1 Maintenance

- 1) Check the connection between power supply plug and socket and ground wiring regularly;
- 2) In some cold areas (below 0°C), if the system will be stopped for a long time, all the water should be released in case of freezing of inner tank and damage of E-Heater.
- 3) It is recommended to clean the inner tank and E-Heater regularly to keep an efficient performance.
- 4) Check the anode every half year and change if required. For more details, please contact the supplier or the service.

#### How to Change the anode

- Turn off the power, and turn off the water inlet valve.
- Open hot water tap, and decrease the pressure of the inner container.
- Open the drain port, and release about 20L water.
- Unscrew anode according to instruction.
- Replace with a new one, and make sure effective sealed.
- Open cold water valve until hot water flows out, and turn off the hot water tap.
- Restart and can be used normally.

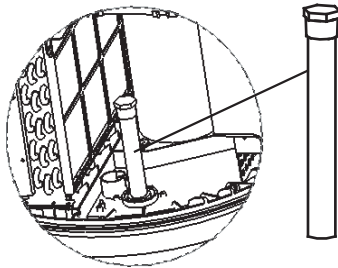

- 5) Clean the air filter every year to maintain heating performance.

The method to dismantle the filter is: unscrew the air inlet ring, take out the filter and clean it completely, finally, remount to the unit. For unit with duct, remove duct first then follow above instruction.



### NOTE

How to Take Off The Air Filter, remove screw from top cover.

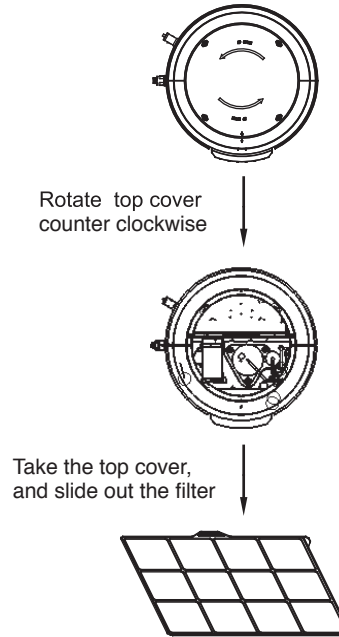

When installing the top cover please refer to the direction of arrow, after assembling it should be line up.

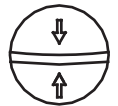

### 8.2 Recommended regular maintenance table

Table. 8-1

Checking Item	Checking content	Checking frequency	Action
1	air filter (inlet/outlet)	every month	Clean the filter
2	anode rod	every half year	Replace if required
3	inner tank	every half year	Clean the tank
4	e-heater	every half year	Clean e-heater
5	PTR valve	every year	Operate the handle of PTR valve to ensure that waterways are clear.
			If water doesn't flow freely when operating the handle, replace PTR valve with a new one

## 9. SPECIFICATIONS

Table. 9-1

Model		EcoSpring ES190			
Mode		Economy Mode	Hybrid Mode		E-Heater Mode
Water-heating Cap.		1500W	Heat Pump	E-Heater	2150W
			1500W	2150W	
Rated input power /Current		780W/3.4A	2780W/12.1A		2150W/9.3A
Power supply		220-240V~ 50Hz			
Operation control		Auto/Manual startup, real time control, error alarm, etc			
Protection		High-pressure Protector, Over-load Protector, Temp Controller&Protector, Electric Leakage Protector, etc			
Compressor power		440W			
E-heater Power		2150W			
Regrigerant		R134a(0.8kg)			
Water pipeline system	Outlet water temp.	Default 60℃, (38℃-70℃ adjustable )			
	Water side exchanger	Surface heat exchanger			
	Inlet Pipe Dia.	DN20			
	Outlet Pipe Dia.	DN20			
	Drainpipe Dia.	DN20			
	PT Valve Dia.	DN20			
	Min/Max. Pressure	0.15MPa/0.7MPa			
Exchanger Air side	Material	Hydrophilic aluminum fin, inner groove copper tube			
	Motor power	40W			
	Outlet Air Type	Air out from sideward			
Fusible Link Type		T5A 250VAC			
Dimension		Φ568×1580mm			
Water Tank Cap.		190L			
Net Weight		90kg			
<p>The test conditions:                      Ambient temperature 20/15℃ (DB/WB),                      Water temperature from 15℃ up to 45℃.</p>					
Warranty		3 Year Comprehensive			